



**BIKE
LANE
DESIGN
GUIDE**

Table of Contents

Foreword	1
Chicago's Bike Lane Design Manual	2
Likely Differences from Chicago's Standards	5
Mid-block Cross Sections	
2-way street with parking on both sides	
44'	7
46'	8
48'	9
50'	10
55'	11
2-Way street without parking	
30'	12
44'	13
50'	14
1-Way street with parking on both sides	
48'	15
Intersections	
Channelized arterial	
48'	16
50'	17
60'	18
Intersection with arterial street	
Two-way	19
Two-way, limited parking	20
One-way	21
Intersection with local street	
Two-way	22
One-way	23
One-way Tee	24
Bus Stop	
Channelized, near side stop	25
Channelized, far side stop	26
Non-channelized, near side stop	27
Non-channelized, far side stop	28
Mid-block	29
Local T	30
Symbols	
Bike lane symbol	31
Bike lane arrow	32
Standard spacing	33
Diagonal striping detail	34
Signs	
Lane Ahead	35
Lane Ends	36
Right Lane Bike Only	37
Right-Turn Only Except Bikes	38
Right-Turn Only Except Bikes and Buses	39
Shared Lane Yield to Bikes	40
Bike Lane Intersection	41
Typical Bike Lane Signage	42
Frequently Asked Bike Lane Questions and Appropriate Responses	43

Foreword

The Pedestrian and Bicycle Information Center is delighted to partner with the City of Chicago and Chicagoland Bicycle Federation to make available this Bike Lane Design Guide. One critical role of the PBIC is to disseminate best practices; to provide access to the tools and resources with which communities can be changed for the better.

As with all “best practice”, the information in this guide has to be carefully applied in your community. The Chicago bike lane design guide shows what works in the City of Chicago and is an excellent example of how facilities for bicyclists can be integrated into the layout of busy urban streets. The guide essentially shows how bicycles can be retrofitted into an existing street system—if your city or community is building streets from scratch, you may not have to deal with the constraints of a 44 foot cross section. Your local conditions, engineering standards, and manuals may differ from those in Chicago, and some of the more significant likely differences have been identified and discussed in this guide. You should not treat the drawings in the guide as a template that will work in every situation, for even in the City of Chicago bike lane designers have to use their best engineering judgment in solving situations that may arise on any given street.

If your community is just embarking on a program of marking bike lanes for the first time you should take the time to educate drivers, local politicians and even the cycling community as to how the lanes will operate, where they will be installed, and how they should behave when encountering them.

Finally, to discover a wide variety of other useful resources for changing communities, check back regularly to www.bicyclinginfo.org and www.walkinginfo.org.

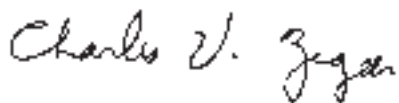

Charlie Zegeer
Director, Pedestrian and Bicycle Information Center

Chicago's Bike Lane Design Manual

Background

The Chicago Department of Transportation has compiled a series of technical drawings and design specifications for bike lanes to:

- Provide clear and comprehensive design guidelines to city, county, and state transportation agencies and their consultants working on road projects with bike lanes;
- Facilitate public acceptance and government approval of bike lane design;
- Serve as a technical reference to insure that all bike lanes are installed to consistently high standards; and
- Serve a wide audience including engineers, technicians, planners, other agency staff, citizens, and elected officials.

Nick Jackson, Director of Planning for the Chicagoland Bike Federation and David Gleason, a University of Illinois engineering student, developed the manual. Ben Gomberg, the City of Chicago's Bicycle Program Coordinator, was the project manager.

In each specification and drawing, the following principles were applied.

- Specifications are concurrent with the Manual on Uniform Traffic Control Devices (1) and the AASHTO Guide for the Development of Bicycle Facilities (2), with one notable exception. The AASHTO Guide allows for a four foot wide bike lane in some cases; the Chicago manual uses an absolute minimum of five feet.
- Cars and bicycles are illustrated on all drawings to increase awareness that cyclists use city streets, and to assist comprehension for non-traffic engineers.
- All drawings are to a scale of:
 - 1"-1' for bike lane symbol and arrow specifications
 - 1"-10' for mid block cross section specifications, and
 - 1"-30' for all intersection and bus stop specifications.
- Both metric and imperial measurements are provided for all lane types, setback spacing and mid-block lane widths.
- The bike lane symbol and arrow specifications include installation directions such as allowable temperature ranges, adhesion and tamping requirements.

History of Chicago's Bike Lane Design Standards

Most bicycling in Chicago takes place on relatively narrow streets with high volumes of cars, bikes, buses, and pedestrians. In surveys collected for the 1998 "Streets for Cycling Plan", cyclists requested bike lanes on numerous streets which field measurements revealed to be 44 feet wide.

A new bike lane is striped on Lincoln.

While bike lanes had been successfully installed in Chicago on streets as narrow as 46 feet, striping them on 44 feet wide streets would require marking a seven foot parking lane to accommodate 5 foot bike lanes and 10 foot travel lanes. The national “Policy on Geometric Design of Streets and Highways” (3), or “Green Book” allowed at that time for a minimum parking lane width of only 8 feet, although the 2001 edition does now have an allowance for 7 foot parking lanes. There were additional concerns with installing a designated bicycle facility on crowded commercial streets with traffic volumes in excess of 15,000 to 20,000 vehicles a day.



City staff surveyed the experiences of numerous North American cities with striping bike lanes on streets as narrow as 44 feet. The results, which were published in Bicycle Forum issue 47 (4), revealed that many cities were indeed installing bike lanes on streets as narrow as those proposed in Chicago. Given this experience and the demonstrable latent demand for bike lanes, the city agreed to install bike lanes for a trial period, using temporary tape, on two streets. Halsted and Lincoln Streets were chosen as popular cycling streets with peak flows of more than 150 cyclists per hour. The test lanes were installed in the summer of 1999. The local city alderman distributed a graphic flyer explaining how the bike lanes worked. The lanes proved popular with cyclists, there was a reduction in overall crash severity, and there was no degradation in motor vehicle level of service at the intersections. As a result, the stripes were permanently installed in 2000 and the cross section (7 foot parking, 5 foot bike lane, 10 foot travel lane) was the starting point for the Chicago Bike Lane Design Manual.

Between 2000 and 2002 the Chicago Department of Transportation received two federal Congestion Mitigation and Air Quality Improvement grants to design and construct 75 miles of bike lanes on city streets. The standard specifications for streets and intersections that follow were developed to implement this bike lane striping program and cover nearly every street configuration encountered on the network.

Design Details

Line Type and Thickness. Bike lanes in Chicago are marked with three different lines. When a bike lane is striped against a curb and parking is prohibited, an 8-inch solid white line is used to separate the bike lane from the adjacent travel lane. On streets with on-street parking, a 4-inch wide solid white line defines the parking lane and a 6-inch wide solid white line defines the outer edge of the bike lane. Where the outer line is dashed, the dash (or dot) is 2 feet long and 6 inches wide, with a six foot gap between dashes.

Intersections. Intersections present one of the most significant design challenges on streets with bike lanes. If space allows, the outer bike lane stripe is dotted all the way to the stop bar at controlled intersections, and to the extension of the property line at uncontrolled intersections. This alerts cyclists to the potential for motorists to be crossing their path and encourages safe merging in advance of the intersection. (e.g. bike lane with parking; intersection with 2-way arterial street)

When a bike lane intersects with a one way street, or where right turns are prohibited, the bike lane is solid all the way to the intersection. (e.g. bike lane with parking; intersection with 1-way arterial street)

Chicago has developed a sign showing the arrangement of lanes at an intersection with a dedicated right turn only lane.

Historically, Chicago has widened major intersections to improve capacity by allowing for opposing left turn lanes and two through lanes in each direction. This often leaves no room for a bike lane at the intersection—and so the outer bike lane stripe is dropped at the beginning of the taper for the turn bay. The parking lane line is continued toward the intersection to encourage drivers to park closer to the curb and provide more room for the cyclist. (e.g. bike lane at 50' wide intersection)

When bike lanes are considered for streets with channelized intersections the curb lane is designated with markings and signs indicating “Right Turn Only Except for Bikes”. This improves safety for cyclists by preventing through motorists from passing on the right while still allowing through cyclists to use the lane. Signage also indicates that motorists should yield the shared lane to the cyclist. (e.g. typical bike lane signage)

When the width allows, the bike lane is dotted to encourage right-turning vehicles to merge right. The bike lane then continues for a minimum of 30 feet until the stop bar. (e.g. bike lane at 60' wide intersection)

Parking Setbacks. On-street parking is available throughout Chicago. Sight distance requirements restrict vehicle parking within 20 feet of all intersections. On streets with bus routes, parking is prohibited for 80 feet to allow space for buses to pull to the curb. The 4-inch bike lane stripe is dropped to allow for turning movements and the lane line is dotted to indicate where merging should occur.

Bike Lane Symbol and Arrow. Chicago uses a bike lane symbol based on that used in Toronto. The elegant design is simple and clearly recognizable to both motorists and cyclists. Because most of Chicago's bike lanes are striped adjacent to on-street parking with high turnover, proper installation of the markings is essential to reduce premature tearing.

The Future

The Chicago Bike Lane Design Manual is a work in progress. Revisions are scheduled for May 2003; comments and suggestions for improvement are welcomed.

References

- (1) Manual on Uniform Traffic Control Devices, Millennium edition, 2000. Federal Highway Administration, Washington, DC. <http://mutcd.fhwa.dot.gov>.
- (2) Guide for the Development of Bicycle Facilities, 1999. American Association of State Highway and Transportation Officials, Washington, DC. www.transportation.org.
- (3) Policy on Geometric Design of Streets and Highways, 2001. American Association of State Highway and Transportation Officials, Washington, DC. www.transportation.org.
- (4) Bicycle Forum, Issue 47. National Center for Bicycling and Walking, Washington, DC. www.bikewalk.org.



Likely Differences from Chicago's Standards

This manual contains bicycle lane design standards that the City of Chicago has chosen to adopt from within ranges that are recommended in currently available manuals, such as the AASHTO Guide to the Development of Bicycle Facilities and the AASHTO Green Book. Your city or agency may have different minimum and maximum dimensions for various elements of street layout. Below you will find three likely areas where slight differences with the City of Chicago standards may be found.

4 foot minimum bike lane width

The City of Chicago does not stripe a bike lane less than five feet in width. However, the AASHTO Guide and some agencies will stripe bike lanes as narrow as four feet wide in certain situations. If you propose to use a four foot bike lane, make sure that the four feet does not include a joint with the gutter pan, or that drainage grates take up some of the width. A four foot bike lane should be clear of all surface irregularities.

The City of Chicago and many other cities will not stripe a four foot bike lane next to parked cars because the width of the bike lane does not allow bicyclists to ride outside the path of opening car doors.

Four foot bike lanes are unlikely to provide adequate separation between motor vehicles and bicycles on streets with multiple lanes (four or more), high speed traffic, and a high percentage of truck and bus traffic.

Defining the parking lane

Some agencies choose not to paint a stripe between the bicycle lane and the parking lane, preferring to leave a 12-13 foot combined parking and bike lane. The advantages of striping the line to define the parking lane include:

The striping encourages motorists to park closer to the curb and thus provide more space for bicyclists in the bike lane, especially when they need to avoid an opening car door. The striping discourages motorists from thinking that the shared bike/parking lane is in fact a travel lane for motor vehicles, particularly when parking is relatively light and turn over is high.

The bike lanes on Halsted were first tried as an experiment and then made permanent.



The bike lane network serves everyday cyclists.

If parking is typically long-term and pretty constant, or if the individual parking stalls are marked with a cross or T, a full stripe between the bike lane and parking lane may not be necessary.

MUTCD signs and markings

The federal Manual of Uniform Traffic Control Devices provides standard signs and markings for bicycle lanes and related bicycle facilities. Agencies should refer to Chapter 9 of the MUTCD for specific details, and should follow instructions in the Manual for experimentation with different signs, markings, and signals.

At the time of writing (June 2002), the Federal Highway Administration has a Notice of Proposed Amendment to the MUTCD that would change the signs and markings that are to be used to designate bicycle lanes. Visit <http://mutcd.fhwa.dot.gov/> to access the most current version of the MUTCD and any proposed changes to the manual.

For additional information on bike lane design and related issues

A variety of additional material on bike lane design and planning is available on-line. For example:

- City of San Francisco, California
<http://sfgov.org/bac/anlreport1001.htm>
www.sfbike.org/campaigns/bicycle_network
- City of Cambridge, Massachusetts
<http://www.ci.cambridge.ma.us/~CDD/envirotrans/bicycle/lanes/bikelane-toc.html>
- City of Philadelphia, Pennsylvania
http://www.phila.gov/streets/the_bicycle_network.html
- City of Portland, Oregon
<http://www.trans.ci.portland.or.us/plans/bicyclemasterplan/default.htm>
- Oregon Department of Transportation
<http://www.odot.state.or.us/techserv/bikewalk/index.htm>
- Florida Department of Transportation
http://www11.myflorida.com/safety/ped_bike/handbooks_and_research/bhchpt4.pdf
- Pedestrian and Bicycle Information Center
www.bicyclinginfo.org
- Association of Pedestrian and Bicycle Professionals
www.apbp.org
- Institute of Transportation Engineers
www.ite.org
- Corvallis, Oregon
<http://www.ci.corvallis.or.us/pw/transport/bikeped.html>



Standard Road Striping Bike Lane on 44' Wide Street

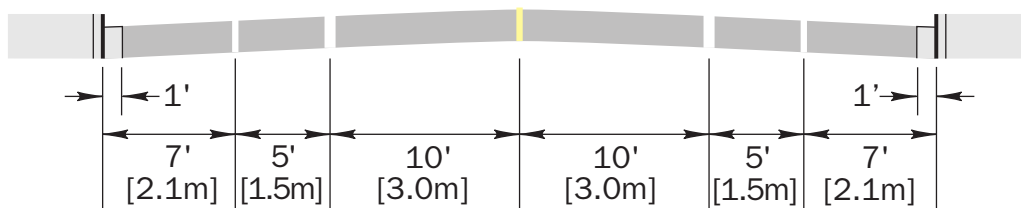

NOTE: Measured curbface to curbface including gutterflag

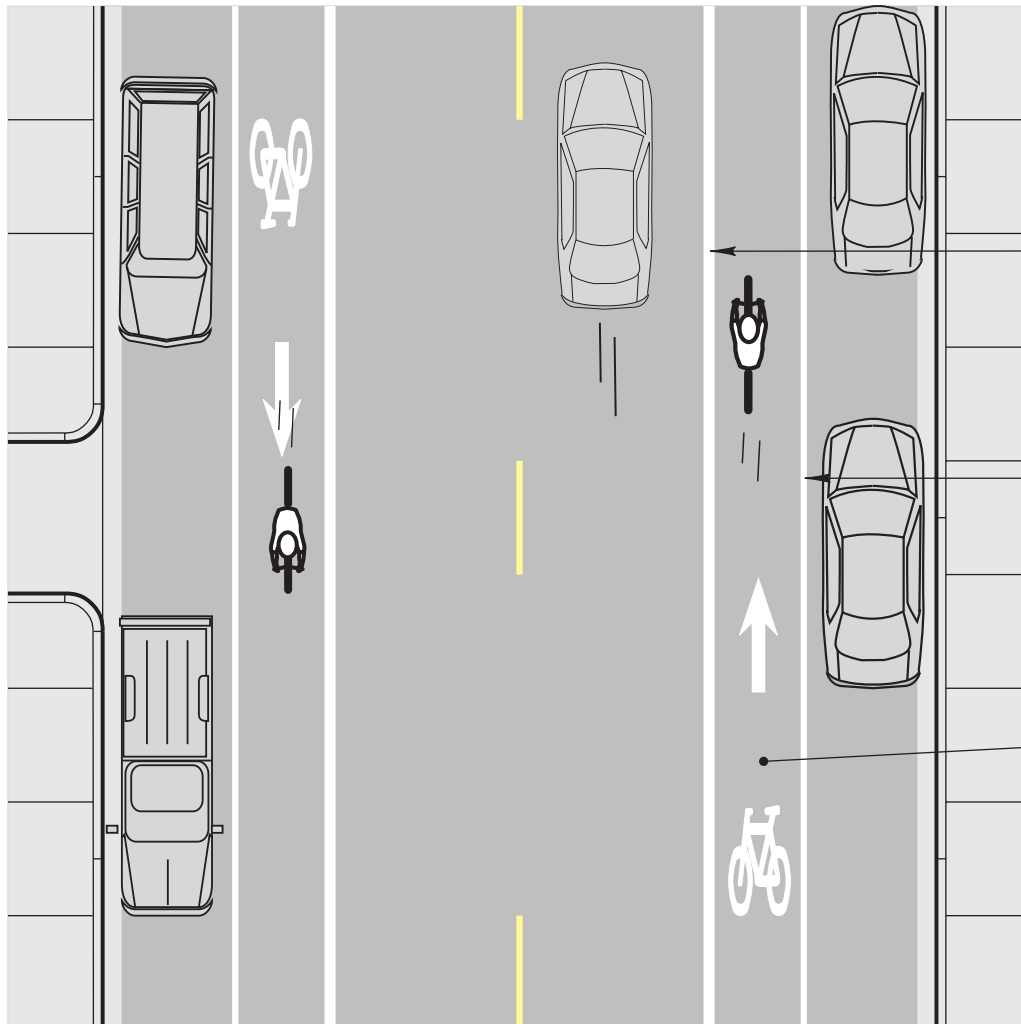

Bike Lane Stripe

Thermoplastic pavement marking line 6" [150mm] wide solid white

Parking Stripe

Thermoplastic pavement marking line 4" [100mm] wide solid white

Bike Lane Symbol & Arrow

Pre-cut plastic

NOTE: Bike lane and parking stripes remain continuous when passing alley and driveway entrances



City of Chicago
Richard M. Daley, Mayor

DEPARTMENT OF TRANSPORTATION
Miguel d'Escoto, Commissioner

BUREAU OF TRAFFIC
Donald Grabowski, Deputy Commissioner

C I T Y O F C H I C A G O

44' Wide Street with Bike Lane

REVISED 5-16-02

SCALE 1"=10'

H:\Traffic\Bike Lanes\Design Manual\Mid-block\2w,pbs\44'.fh8

No. __ of __

Standard Road Striping

Bike Lane on 46' Wide Street

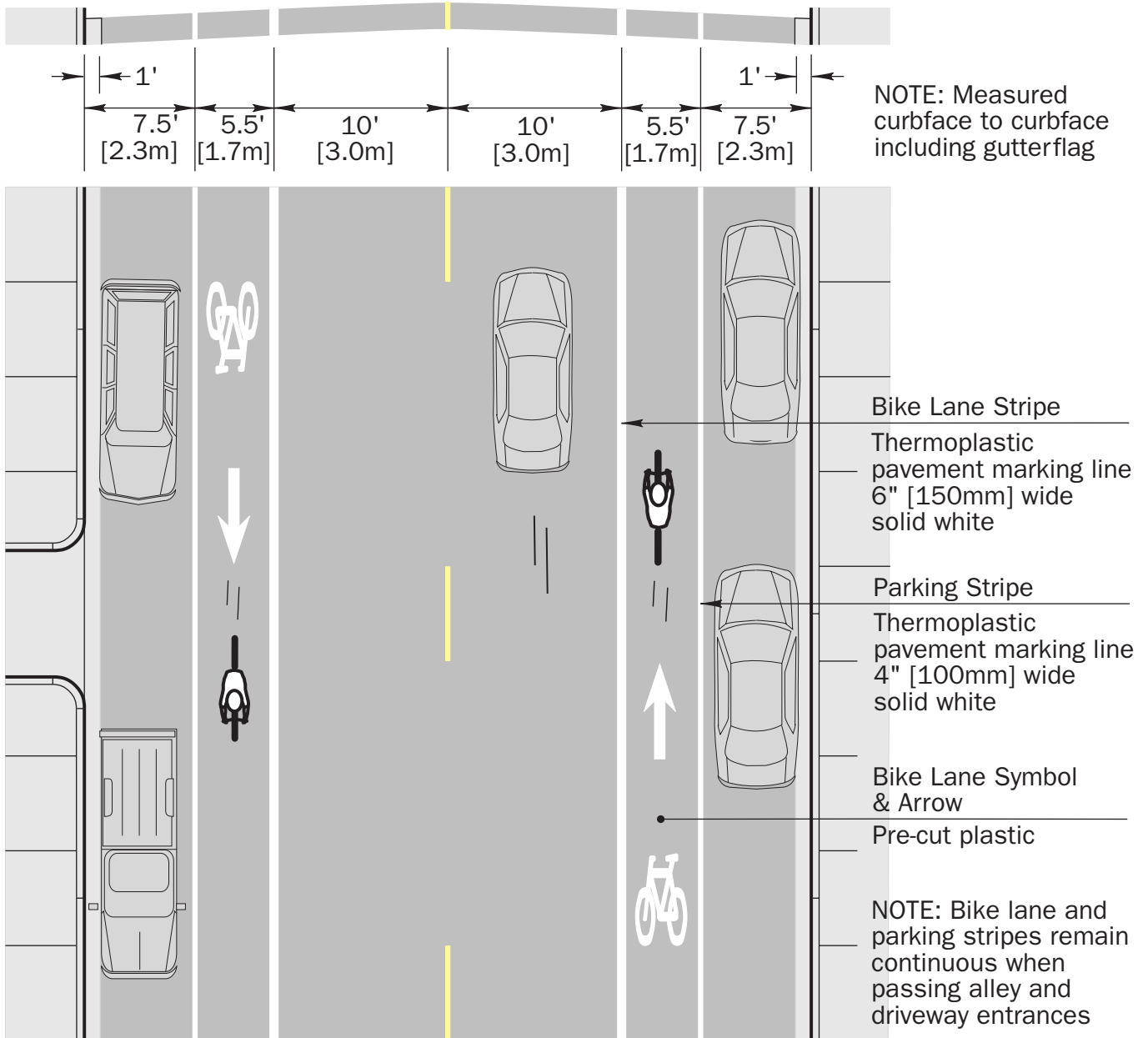

City of Chicago
Richard M. Daley, Mayor

DEPARTMENT OF TRANSPORTATION
Miguel d'Escoto, Commissioner

BUREAU OF TRAFFIC
Donald Grabowski, Deputy Commissioner

CITY OF CHICAGO			
46' Wide Street with Bike Lane			
REVISED	5-16-02	SCALE	1"=10'
H:\Traffic\Bike Lanes\Design Manual\Mid-block\2w,pbs\46'.fh8			No. ___ of ___

Standard Road Striping Bike Lane on 48' Wide Street

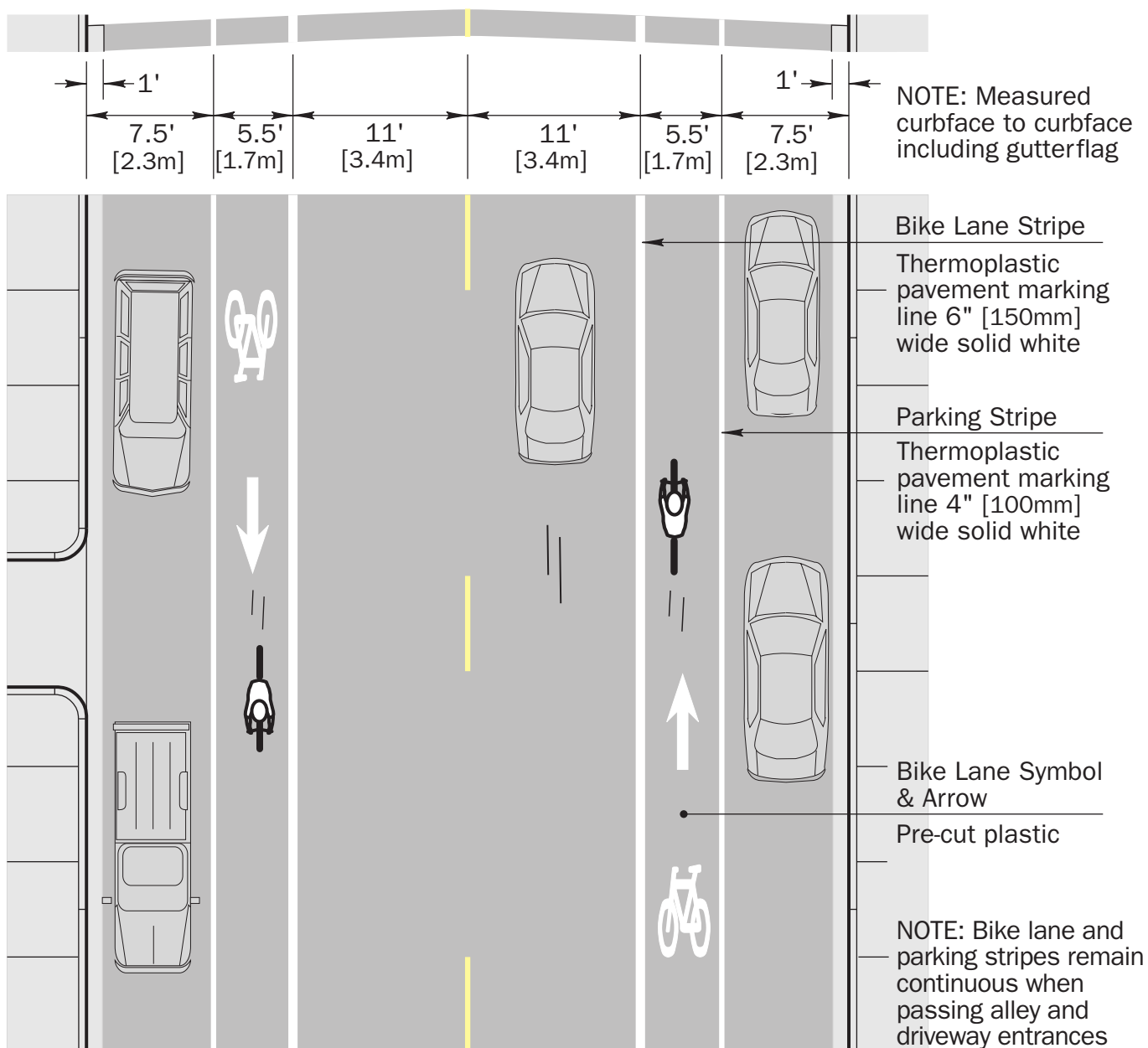

City of Chicago
Richard M. Daley, Mayor

DEPARTMENT OF TRANSPORTATION
Miguel d'Escoto, Commissioner

BUREAU OF TRAFFIC
Donald Grabowski, Deputy Commissioner

CITY OF CHICAGO	
48' Wide Street with Bike Lane	
REVISED 5-16-02	SCALE 1"=10'
H:\Traffic\Bike Lanes\Design Manual\Mid-block\2w,pbs\48'.fh8	No. ___ of ___

Standard Road Striping Bike Lane on 50' Wide Street

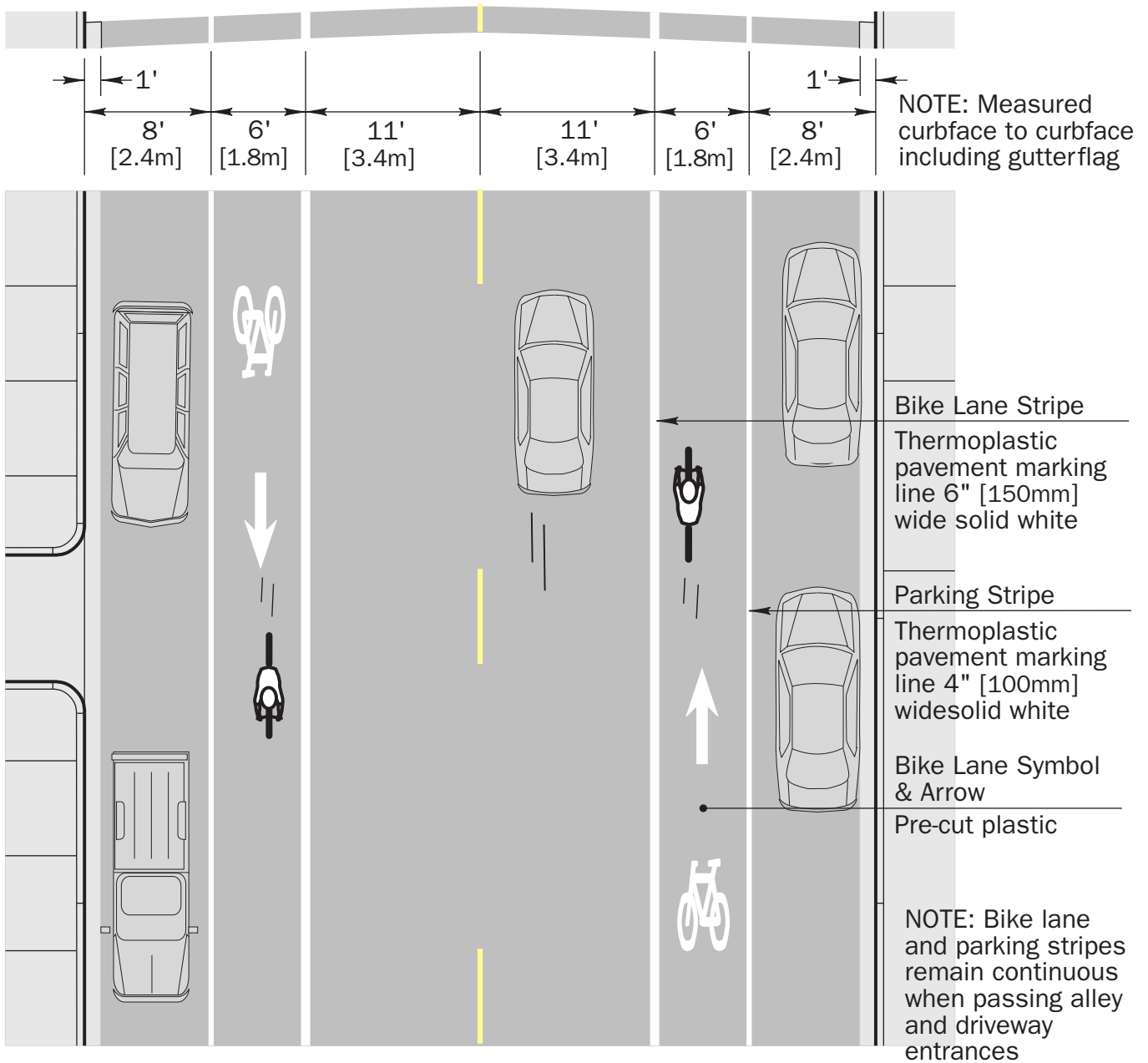

City of Chicago
Richard M. Daley, Mayor

DEPARTMENT OF TRANSPORTATION
Miguel d'Escoto, Commissioner

BUREAU OF TRAFFIC
Donald Grabowski, Deputy Commissioner

CITY OF CHICAGO	
50' Wide Street with Bike Lane	
REVISED 5-16-02	SCALE 1"=10'
H:\Traffic\Bike Lanes\Design Manual\Mid-block\2w,pbs\50'.fh8	No. __ of __

Bike Lane on 55' Wide Street With Parking on Both Sides

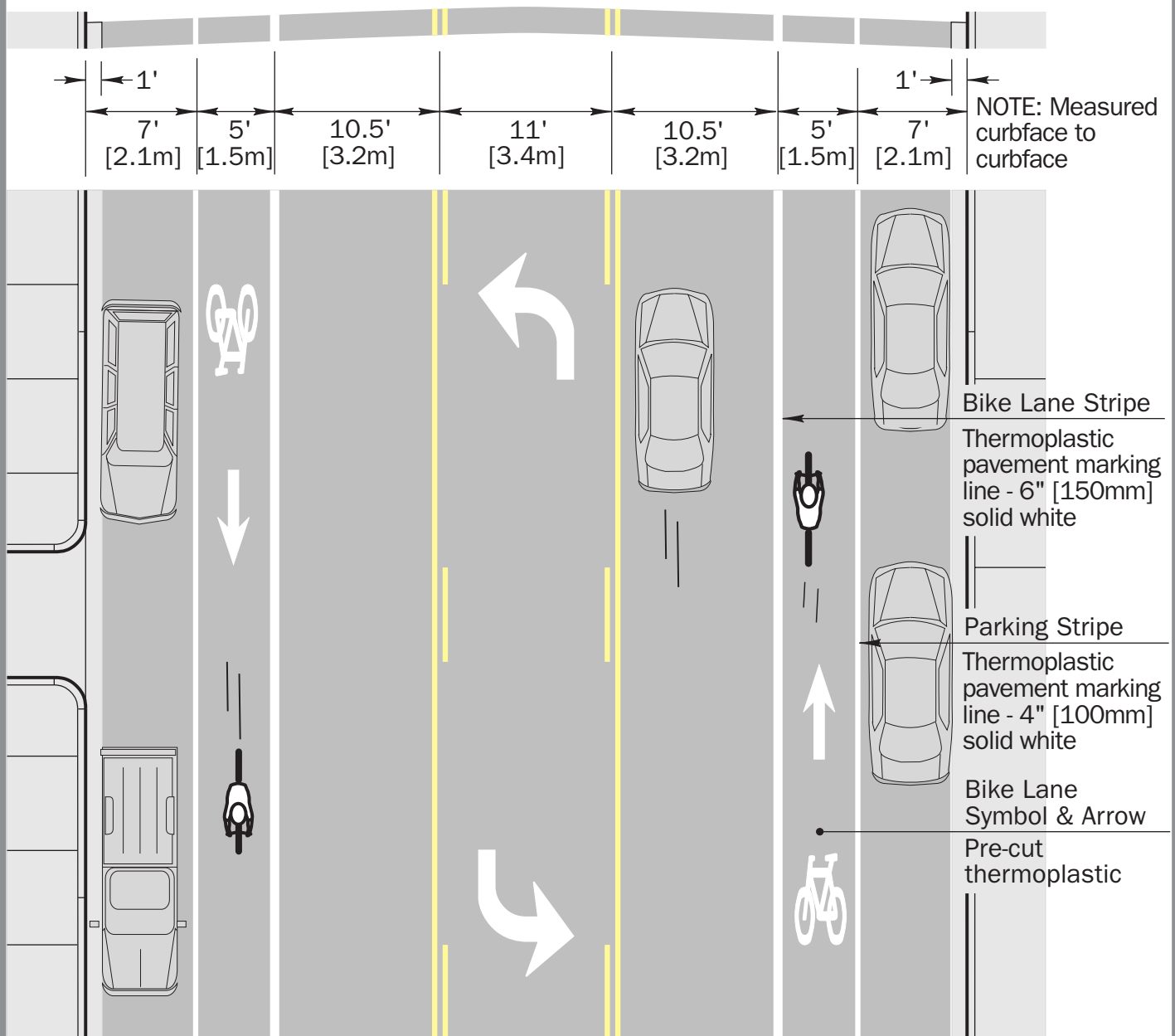

NOTE: Bike lane and parking stripes remain continuous when passing alley and driveway entrances



City of Chicago
Richard M. Daley, Mayor
 DEPARTMENT OF TRANSPORTATION
Miguel d'Escoto, Commissioner
 BUREAU OF TRAFFIC
Donald Grabowski, Deputy Commissioner

CITY OF CHICAGO			
55' [16.7m] Street with Bike Lane			
REVISED	5-16-02	SCALE	1"=10'
H:\Traffic\Bike Lanes\Design Manual\Mid-block\2w,np\55 with Center T.L..FH9			Sheet __ of __

Bike Lane on 2-way Street With No Parking on Both Sides

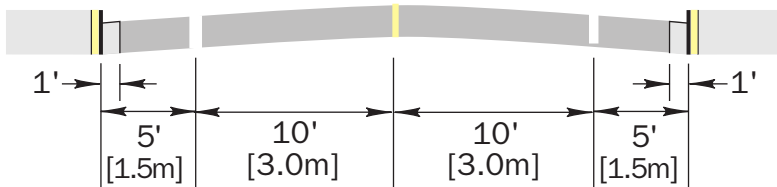

NOTE: Measured curbside to curbside.

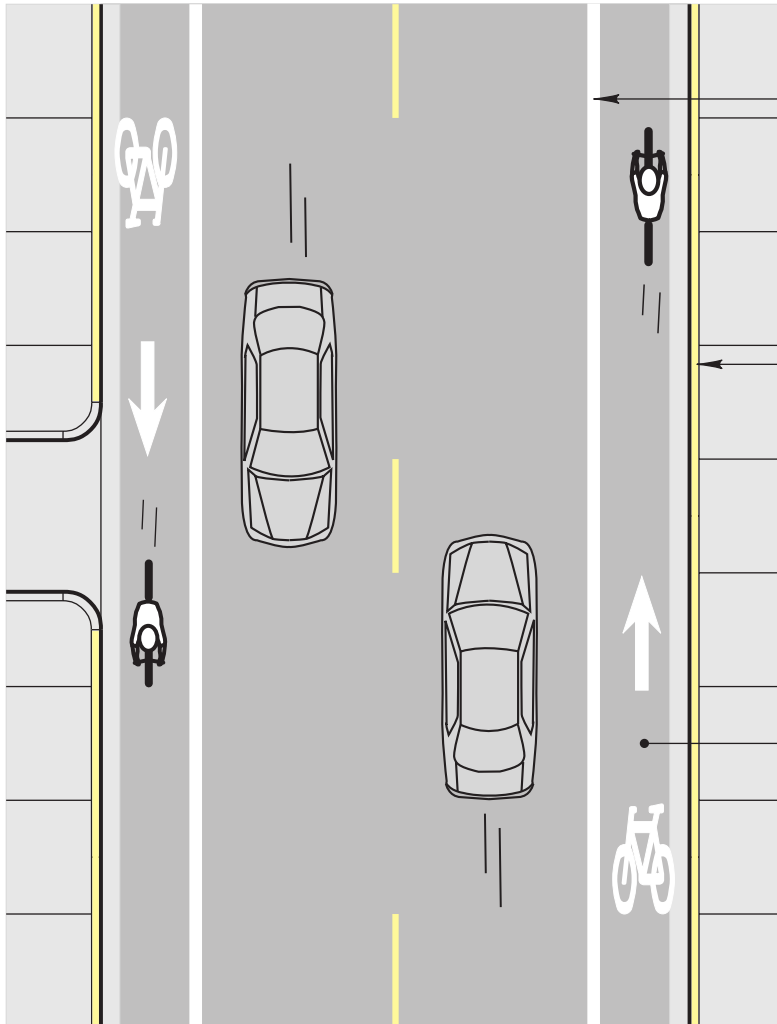

Bike Lane Stripe
 Thermoplastic pavement marking line
 8" [200mm] wide
 solid white

No Parking Stripe
 Pre-formed Inlay Tape marking line
 4" [100mm] wide
 solid yellow

NOTE: Apply to top of curb

Bike Lane Symbol & Arrow
 Pre-cut plastic

NOTE: Bike lane and parking stripes remain continuous when passing alley and driveway entrances.



City of Chicago
 Richard M. Daley, Mayor

DEPARTMENT OF TRANSPORTATION
 Miguel d' Escoto, Commissioner

BUREAU OF TRAFFIC
 Donald Grabowski, Deputy Commissioner

CITY OF CHICAGO			
Bike Lane with No Parking			
REVISED	5-16-02	SCALE	1"=30'
H:\Traffic\Bike Lanes\Design Manual\Mid-block\2w,np\38'.fh8			Sheet ___ of ___

Bike Lane on 44' Wide Street

No Parking on Both Sides

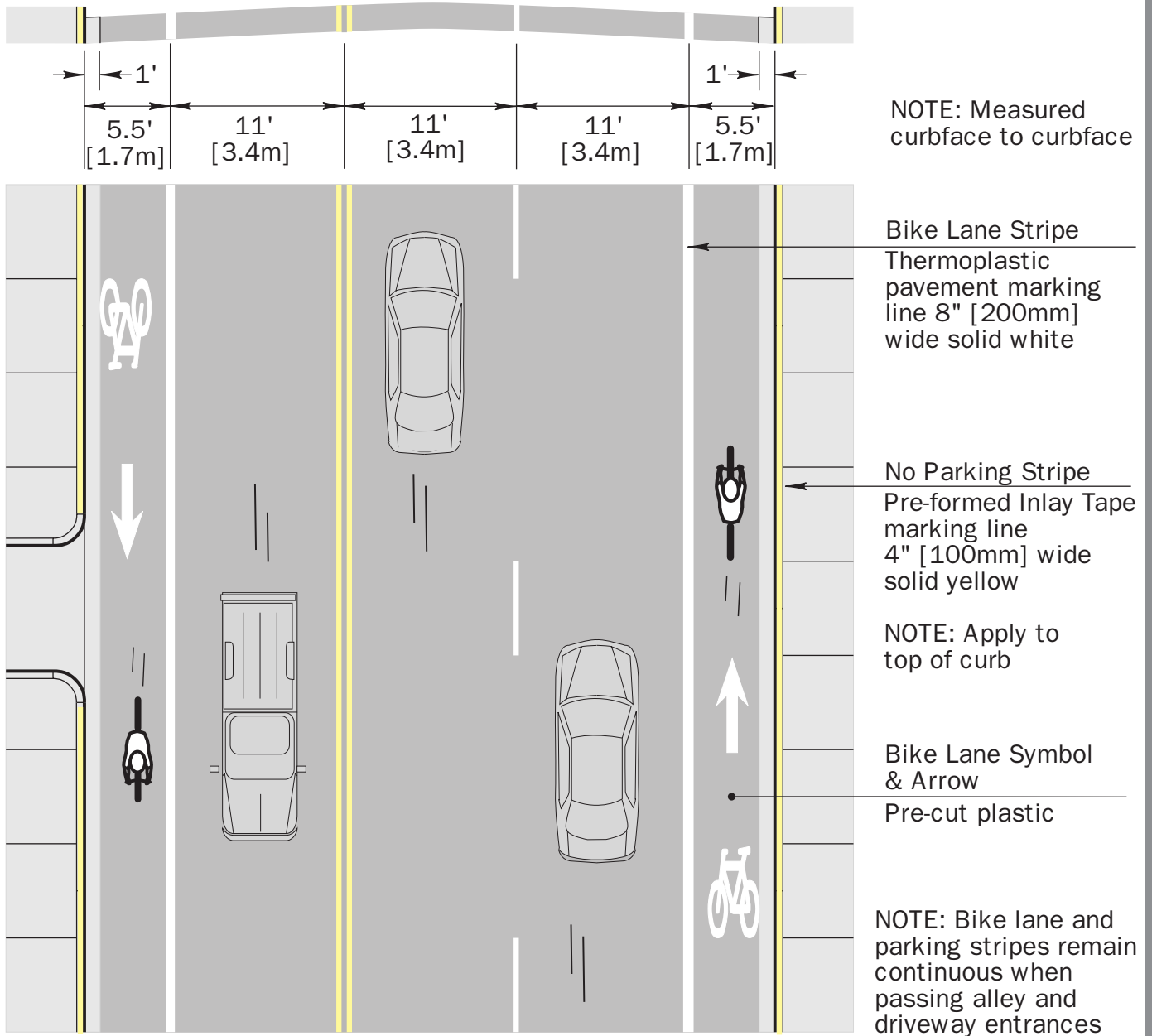

City of Chicago
Richard M. Daley, Mayor

DEPARTMENT OF TRANSPORTATION
Miguel d'Escoto, Commissioner

BUREAU OF TRAFFIC
Donald Grabowski, Deputy Commissioner

CITY OF CHICAGO			
44' Wide Street with Bike Lane			
REVISED	5-16-02	SCALE	1"=10'
H:\Traffic\Bike Lanes\Design Manual\Mid-block\2w,np\44'.fh8			No. ___ of ___

Bike Lane on 50' Wide Street

No Parking on Both Sides

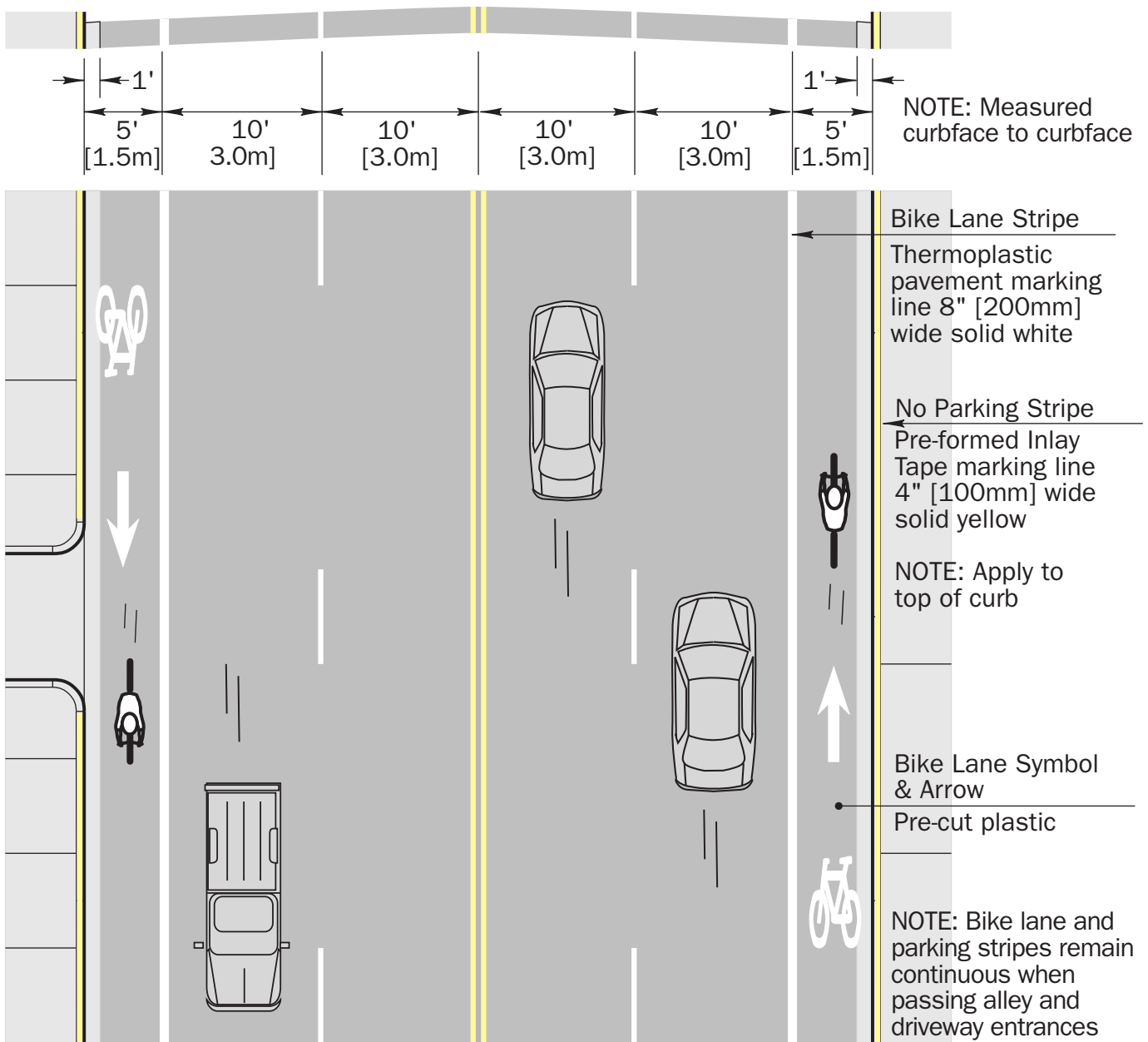

City of Chicago
Richard M. Daley, Mayor

DEPARTMENT OF TRANSPORTATION
Miguel d'Escoto, Commissioner

BUREAU OF TRAFFIC
Donald Grabowski, Deputy Commissioner

CITY OF CHICAGO			
50' Wide Street with Bike Lane			
REVISED	5-16-02	SCALE	1"=10'
H:\Traffic\Bike Lanes\Design Manual\Mid-block\2w,np\50'.fh8			No. ___ of ___

48' Wide One-way Street Parking on Both Sides

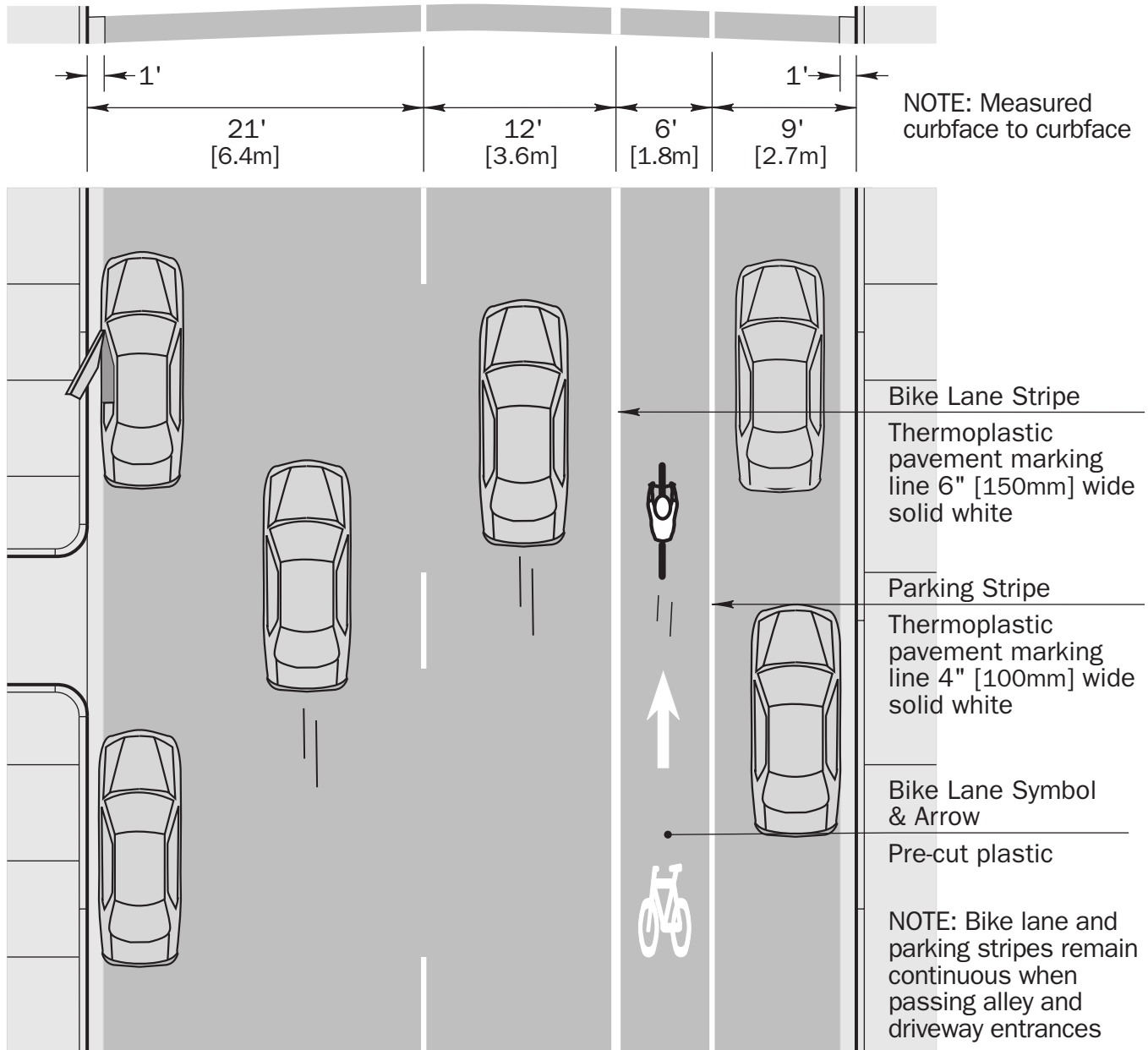

City of Chicago
Richard M. Daley, Mayor

DEPARTMENT OF TRANSPORTATION
Miguel d'Escoto, Commissioner

BUREAU OF TRAFFIC
Donald Grabowski, Deputy Commissioner

CITY OF CHICAGO	
48' Wide One-way Street	
REVISED 5-16-02	SCALE 1"=10'
H:\Traffic\Bike Lanes\Design Manual\Mid-block\1w,pbs\48'-2.FH9 No. __ of __	

Bike Lane at 48' Wide Intersection With Left Turn Bays

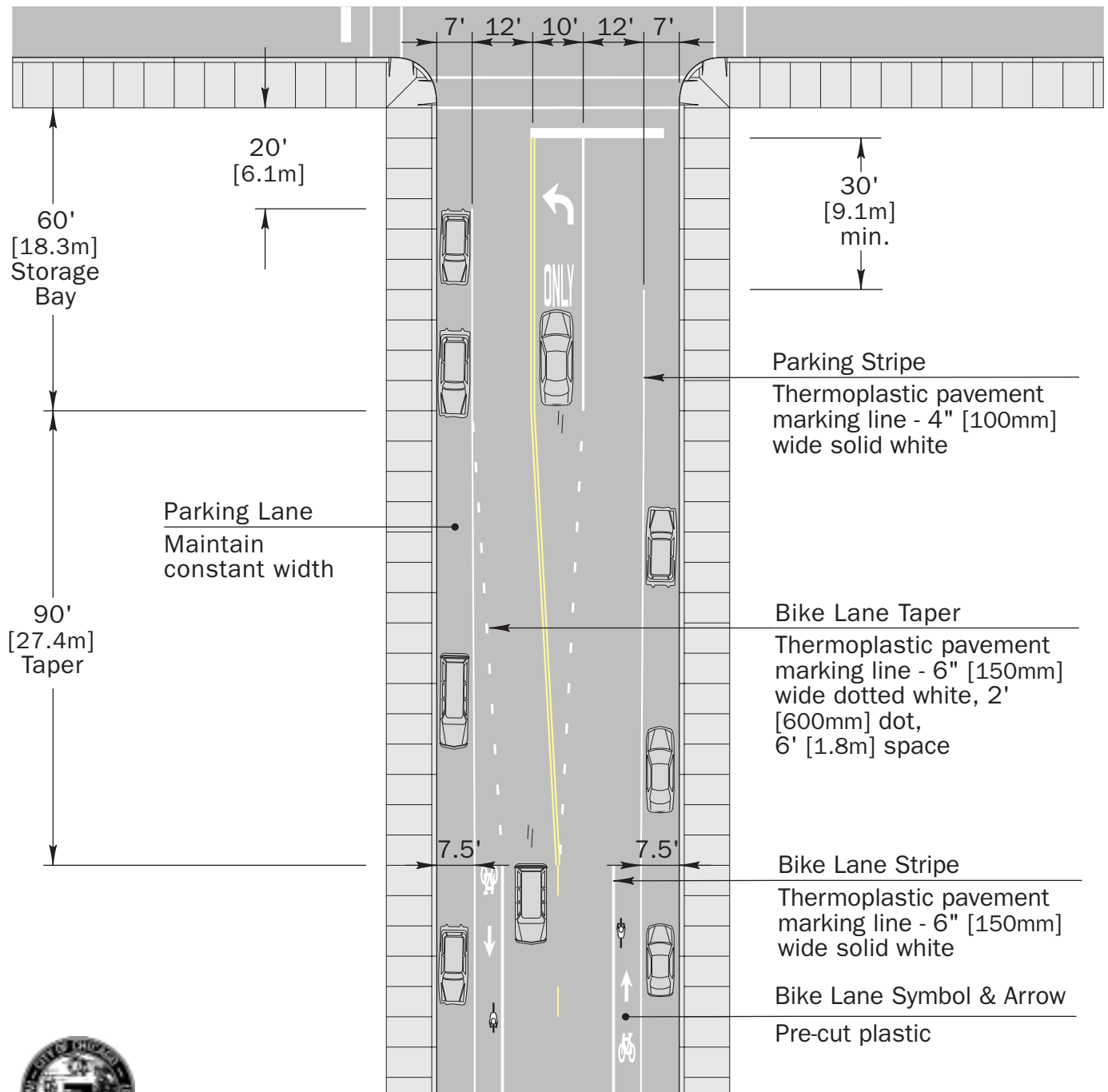

City of Chicago
Richard M. Daley, Mayor
DEPARTMENT OF TRANSPORTATION
Miguel d'Escoto, Commissioner
BUREAU OF TRAFFIC
Donald Grabowski, Deputy Commissioner

C I T Y O F C H I C A G O

Bike Lanes at 48' Wide Intersection

REVISED	5-16-02	SCALE	1"=30'
---------	---------	-------	--------

H:\Traffic\Bike Lanes\Design Manual\Intersections\Channelized\48'.FH9 No. __ of __

Bike Lane at 50' Wide Intersection With Left and Right Turn Bays

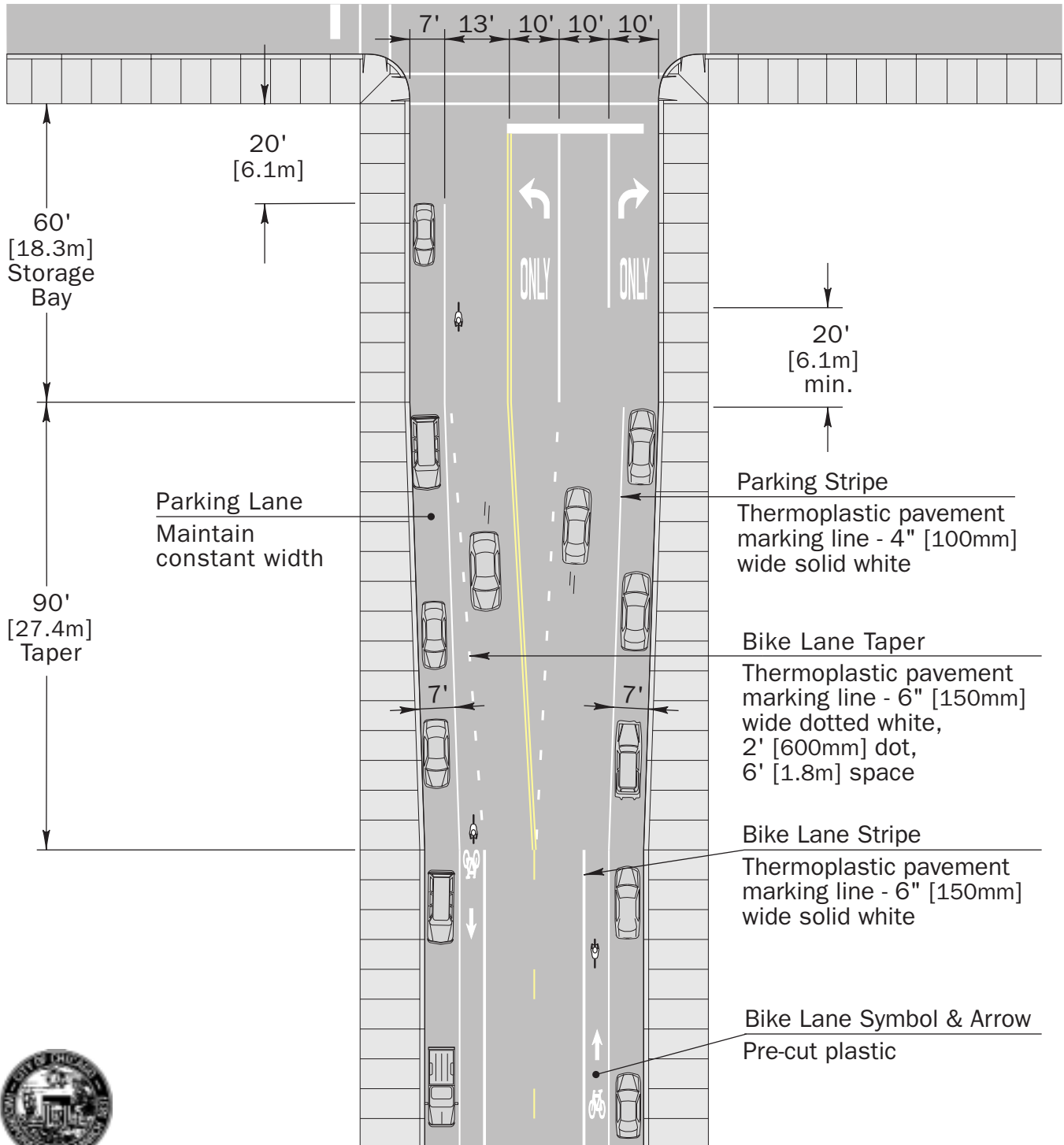

City of Chicago
Richard M. Daley, Mayor
DEPARTMENT OF TRANSPORTATION
Miguel d'Escoto, Commissioner
BUREAU OF TRAFFIC
Donald Grabowski, Deputy Commissioner

CITY OF CHICAGO			
Bike Lane at 50' Wide Intersection			
REVISED	5-16-02	SCALE	1"=30'
H:\Traffic\Bike Lanes\Design Manual\Intersections\Channelized\50'.FH9			No. ___ of ___

Bike Lane at 60' Wide Intersection With Left and Right Turn Bays

Note: Intersection striping must be accompanied by sign **R4-4** indicating right-turning vehicles yield to bikes and sign indicating right-turning bicycles use right-turn only lane.

Note: See **Diagonal Striping Detail** for spacing and line specifications

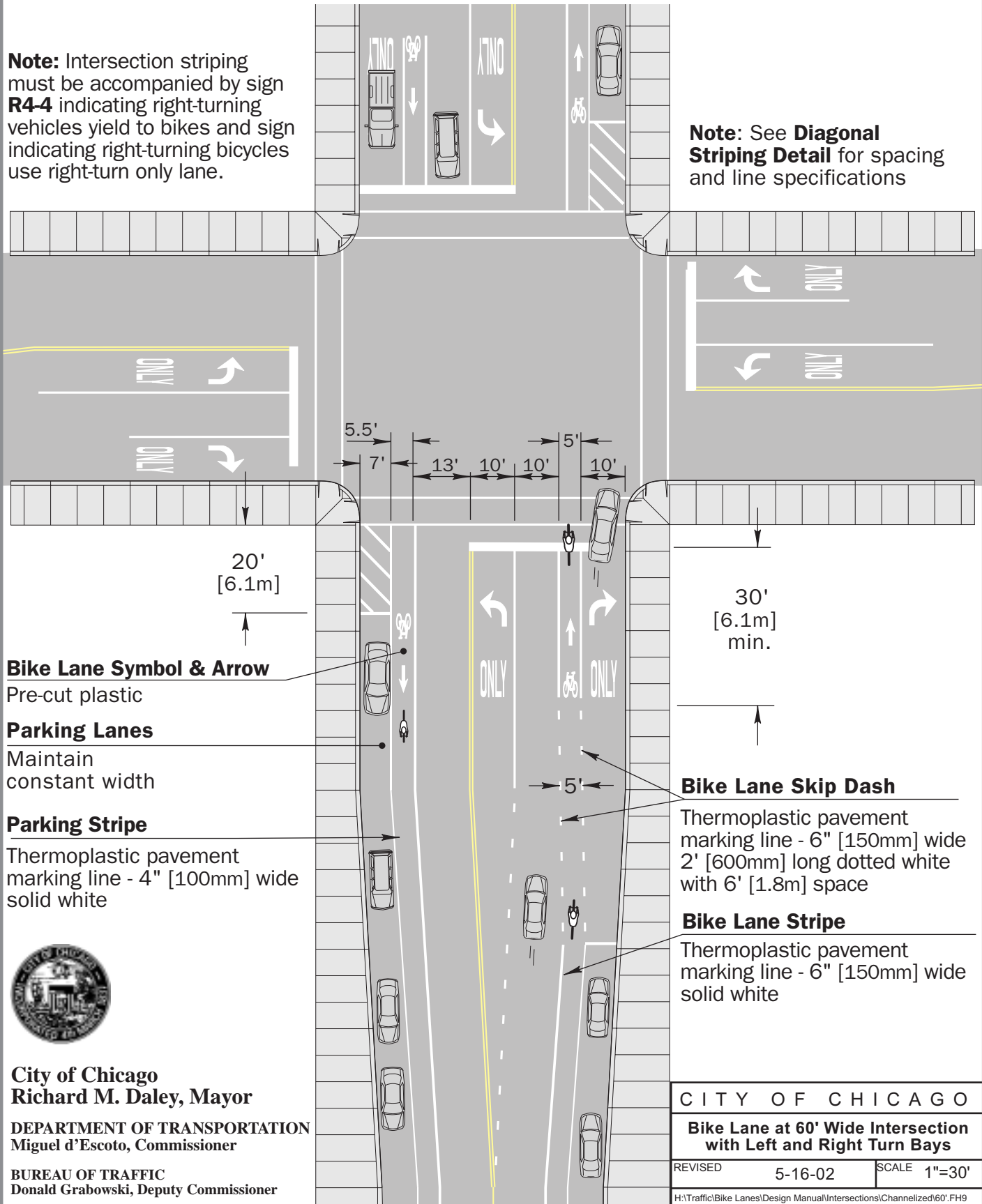

Bike Lane Symbol & Arrow

Pre-cut plastic

Parking Lanes

Maintain constant width

Parking Stripe

Thermoplastic pavement marking line - 4" [100mm] wide solid white



City of Chicago
Richard M. Daley, Mayor

DEPARTMENT OF TRANSPORTATION
Miguel d'Escoto, Commissioner

BUREAU OF TRAFFIC
Donald Grabowski, Deputy Commissioner

Bike Lane Skip Dash

Thermoplastic pavement marking line - 6" [150mm] wide 2' [600mm] long dotted white with 6' [1.8m] space

Bike Lane Stripe

Thermoplastic pavement marking line - 6" [150mm] wide solid white

CITY OF CHICAGO

**Bike Lane at 60' Wide Intersection
with Left and Right Turn Bays**

REVISED 5-16-02 SCALE 1"=30'

H:\Traffic\Bike Lanes\Design Manual\Intersections\Channelized\60'.FH9

Bike Lane with Parking Intersection with 2-way Arterial Street

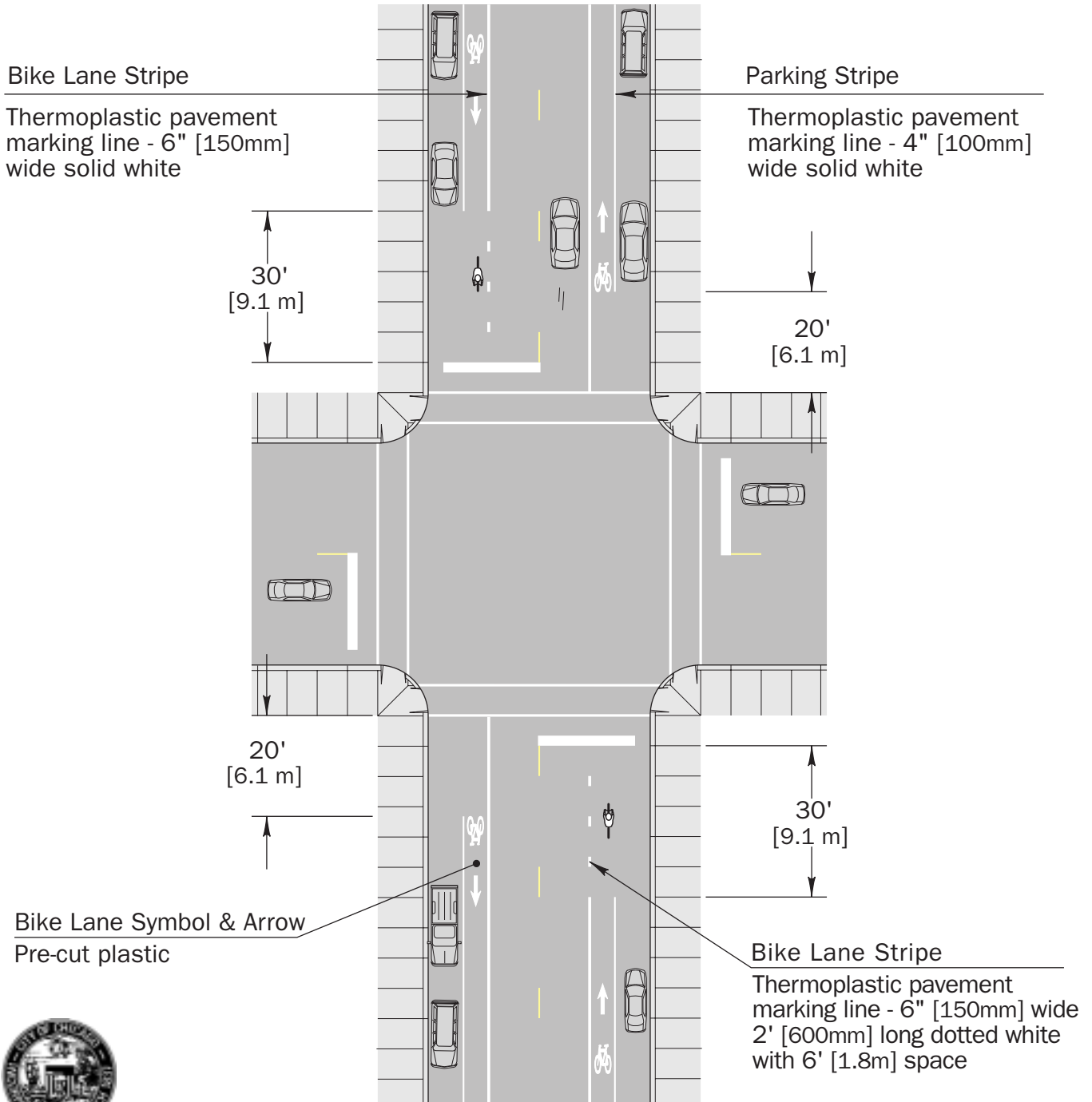

City of Chicago
Richard M. Daley, Mayor
DEPARTMENT OF TRANSPORTATION
Miguel d'Escoto, Commissioner
BUREAU OF TRAFFIC
Donald Grabowski, Deputy Commissioner

CITY OF CHICAGO			
Intersection with 2-way Arterial Street, Parking			
REVISED	5-16-02	SCALE	1"=30'
H:\Traffic\Bike Lanes\Design Manual\Intersections\Arterial street crossing\2Wwp.th8			No. ___ of ___

Bike Lane with Limited Parking Intersection with 2-way Arterial Street

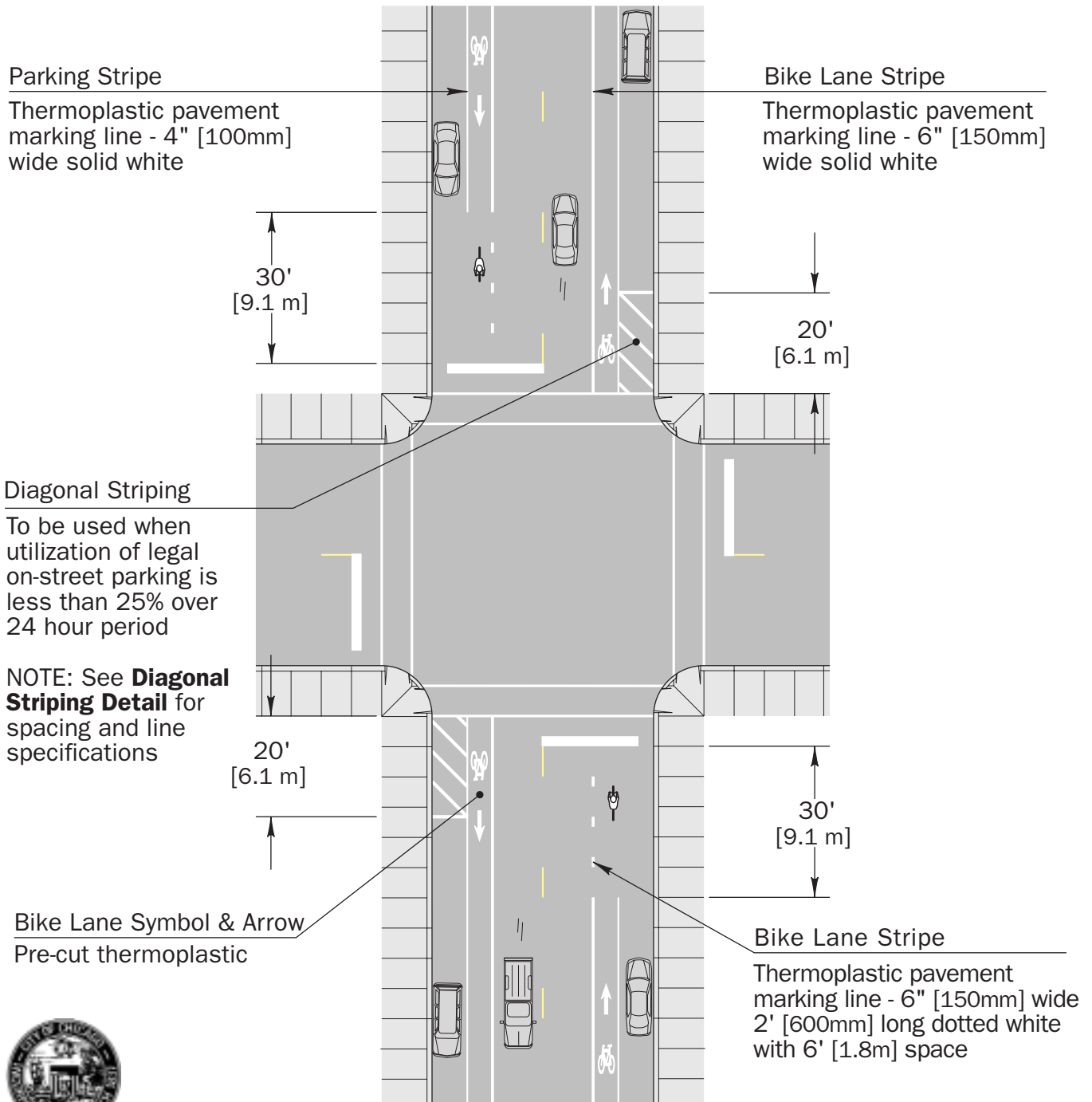

City of Chicago
Richard M. Daley, Mayor

DEPARTMENT OF TRANSPORTATION
Miguel d'Escoto, Commissioner

BUREAU OF TRAFFIC
Donald Grabowski, Deputy Commissioner

C I T Y O F C H I C A G O

Intersection with 2-way Arterial Street, Limited Parking

REVISED 5-16-02

SCALE 1"=30'

H:\Traffic\Bike Lanes\Design Manual\Intersections\Arterial street crossing\2Wwp-limited parking.fn8

No. ___ of ___

Bike Lane with Parking Intersection with 1-way Arterial Street

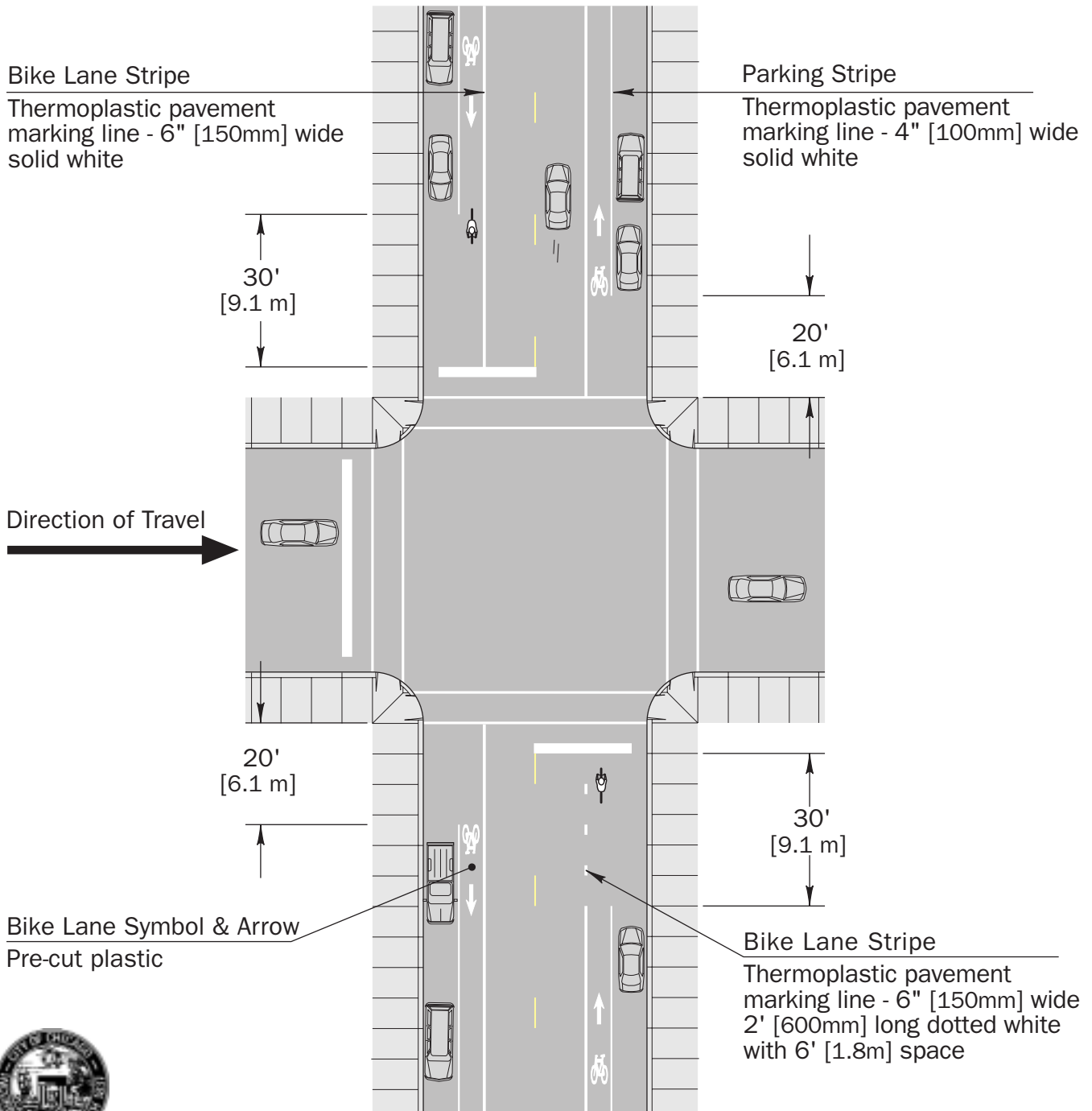

City of Chicago
Richard M. Daley, Mayor
DEPARTMENT OF TRANSPORTATION
Miguel d'Escoto, Commissioner
BUREAU OF TRAFFIC
Donald Grabowski, Deputy Commissioner

CITY OF CHICAGO			
Intersection with 1-way Arterial Street, Parking			
REVISED	5-16-02	SCALE	1"=30'
H:\Traffic\Bike Lanes\Design Manual\Intersections\Arterial street crossing\1Wwp.fh8			No. ___ of ___

Bike Lane with Parking Intersection with 2-way Local Street

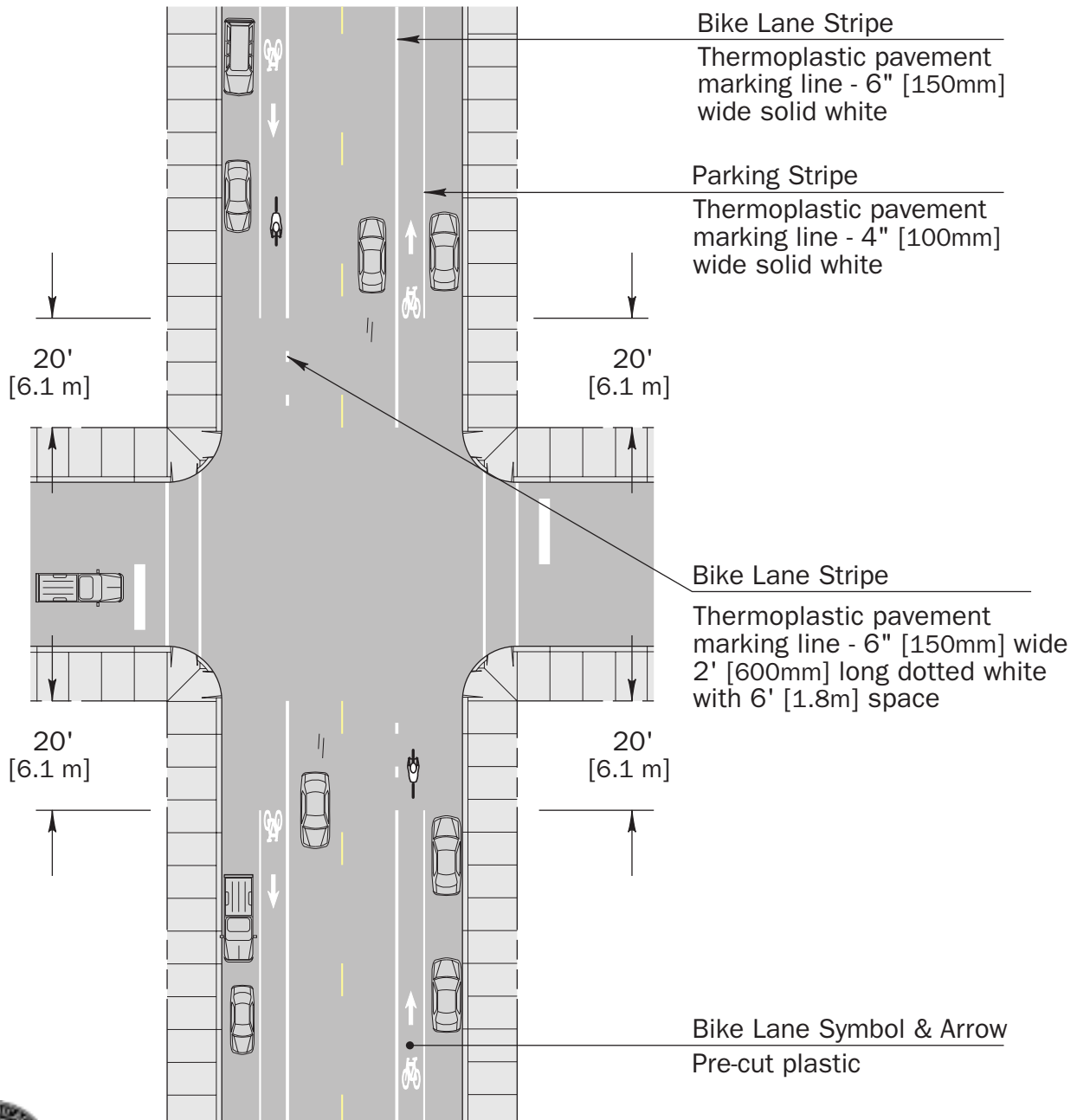

City of Chicago
Richard M. Daley, Mayor

DEPARTMENT OF TRANSPORTATION
Miguel d'Escoto, Commissioner

BUREAU OF TRAFFIC
Donald Grabowski, Deputy Commissioner

C I T Y O F C H I C A G O

Intersection with 2-way Local Street, Parking

REVISED 5-16-02

SCALE 1"=30'

H:\Traffic\Bike Lanes\Design Manual\Intersections\Local2 way with parking.fn8

No. ___ of ___

Bike Lane with Parking Intersection with 1-way Local Street

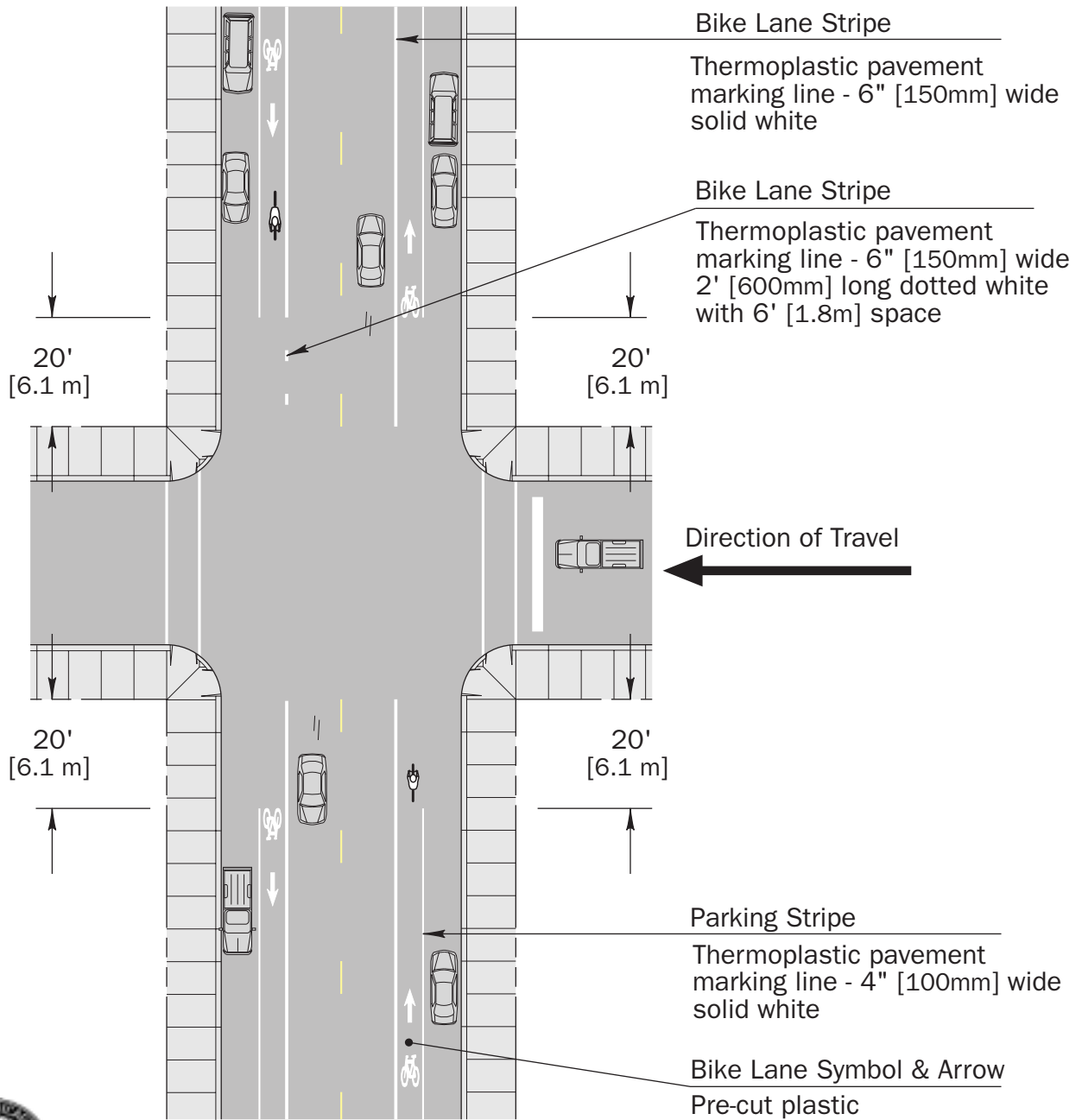

City of Chicago
Richard M. Daley, Mayor

DEPARTMENT OF TRANSPORTATION
Miguel d'Escoto, Commissioner

BUREAU OF TRAFFIC
Donald Grabowski, Deputy Commissioner

C I T Y O F C H I C A G O

Intersection with 1-way Local Street, Parking

REVISED	5-16-02	SCALE	1"=30'
---------	---------	-------	--------

H:\Traffic\Bike Lanes\Design Manual\Intersections\Local\1 way with parking.FH9	No. ___ of ___
--	----------------

Bike Lane with Parking Intersection with One-way Local T

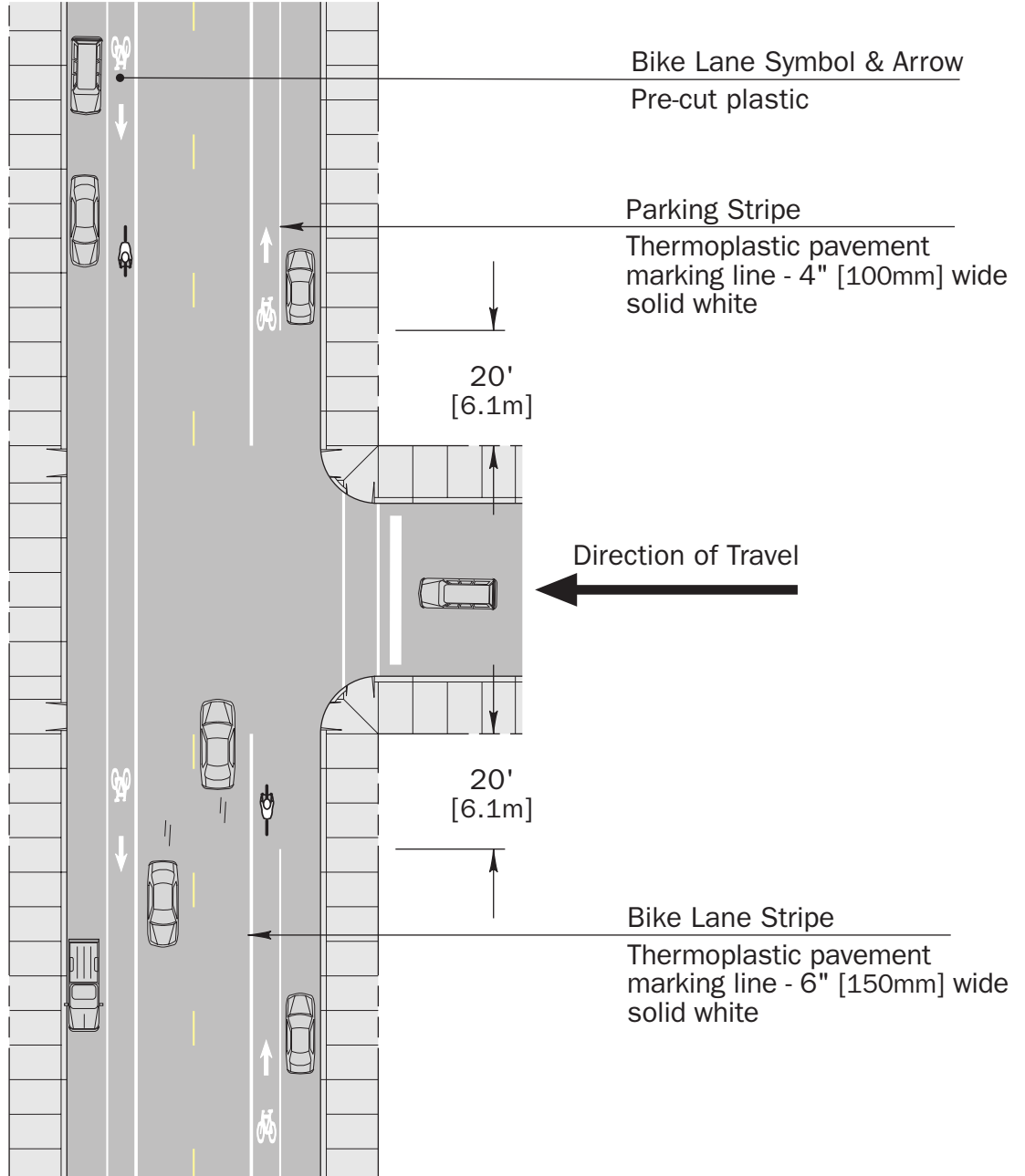

City of Chicago
Richard M. Daley, Mayor

DEPARTMENT OF TRANSPORTATION
Miguel d'Escoto, Commissioner

BUREAU OF TRAFFIC
Donald Grabowski, Deputy Commissioner

CITY OF CHICAGO			
Intersection with One-way Local T, Parking			
REVISED	5-16-02	SCALE	1"=30'
H:\Traffic\Bike Lanes\Design Manual\Intersection\Local\local T 1-way out.fn9			No. ___ of ___

Bike Lane with Bus Stop Channelized Intersection

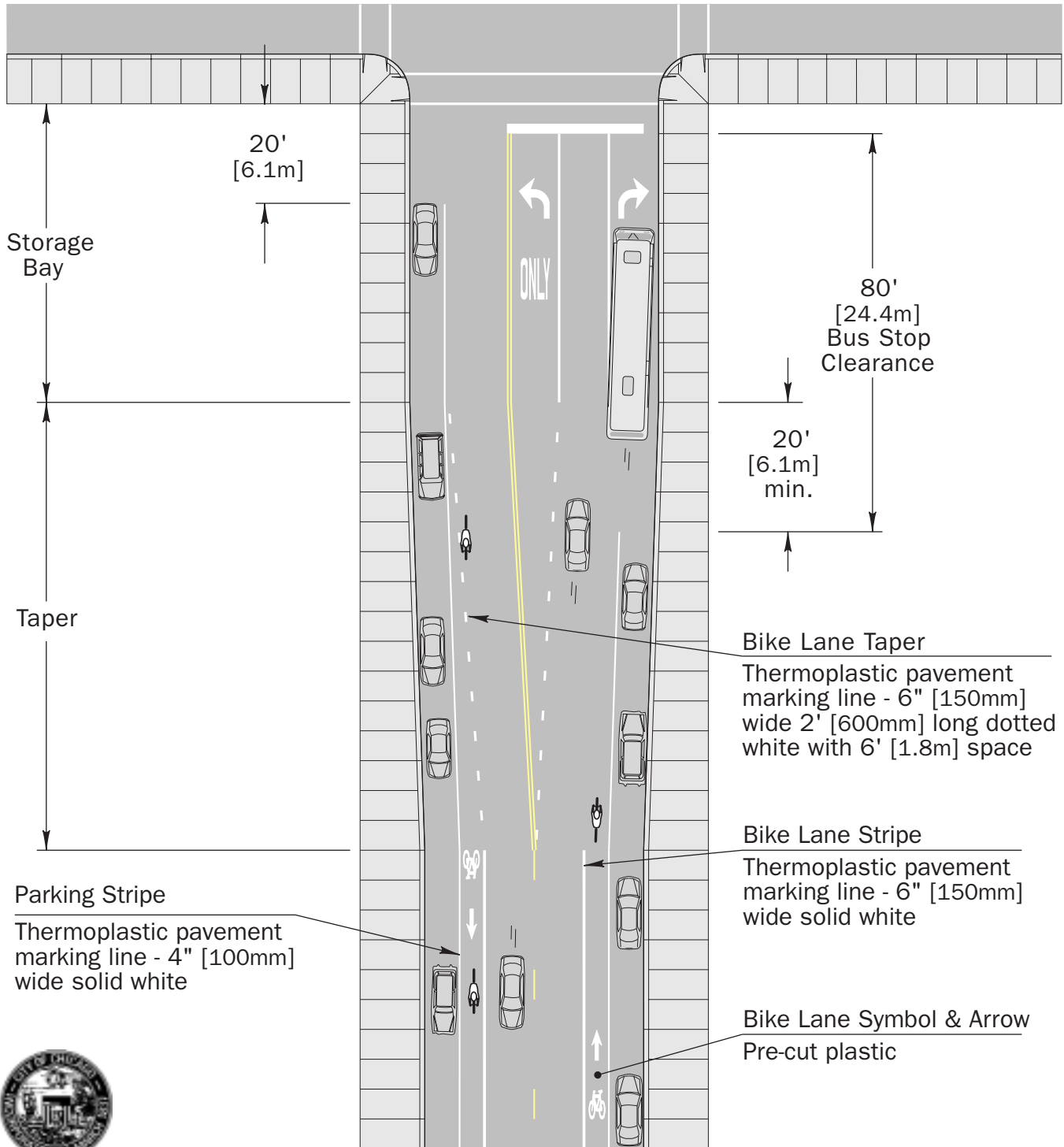

Parking Stripe
Thermoplastic pavement marking line - 4" [100mm] wide solid white

Bike Lane Taper
Thermoplastic pavement marking line - 6" [150mm] wide 2' [600mm] long dotted white with 6' [1.8m] space

Bike Lane Stripe
Thermoplastic pavement marking line - 6" [150mm] wide solid white

Bike Lane Symbol & Arrow
Pre-cut plastic



City of Chicago
Richard M. Daley, Mayor
DEPARTMENT OF TRANSPORTATION
Miguel d'Escoto, Commissioner
BUREAU OF TRAFFIC
Donald Grabowski, Deputy Commissioner

CITY OF CHICAGO			
Bus Stop, Channelized			
REVISED	5-16-02	SCALE	1"=30'
H:\Bike Lanes\Design Manual\Bus Stops\BSatChannel.fh8			No. ___ of ___

Bike Lane with Bus Stop Far-side of Channelized Intersection

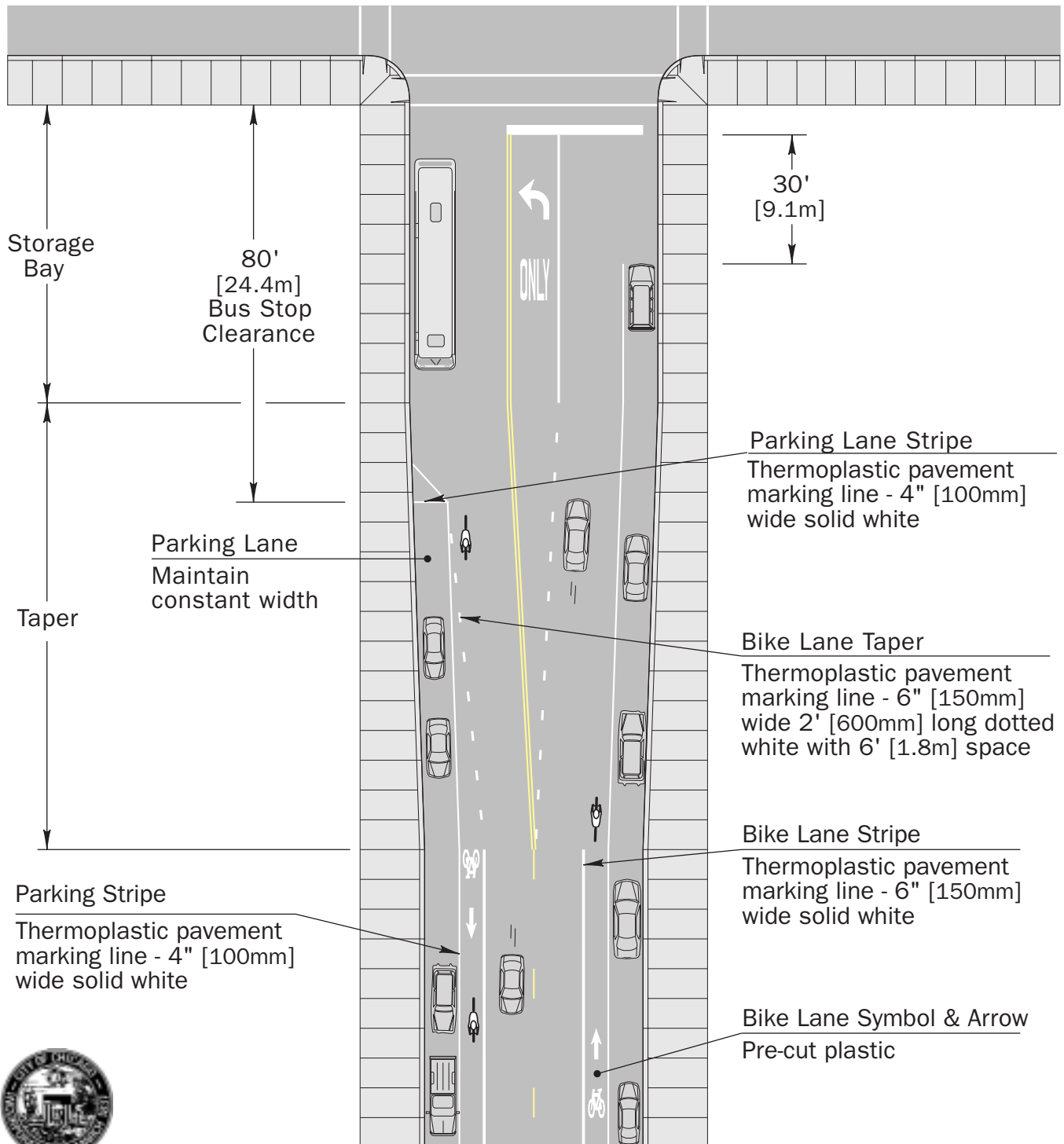

City of Chicago
Richard M. Daley, Mayor

DEPARTMENT OF TRANSPORTATION
Miguel d'Escoto, Commissioner

BUREAU OF TRAFFIC
Donald Grabowski, Deputy Commissioner

CITY OF CHICAGO			
Bus Stop, Far-side Channelized			
REVISED	5-16-02	SCALE	1"=30'
H:\Bike Lanes\Design Manual\Bus Stops\Channel-far.fh8			No. ___ of ___

Bike Lane with Bus Stop Non-Channelized Intersection

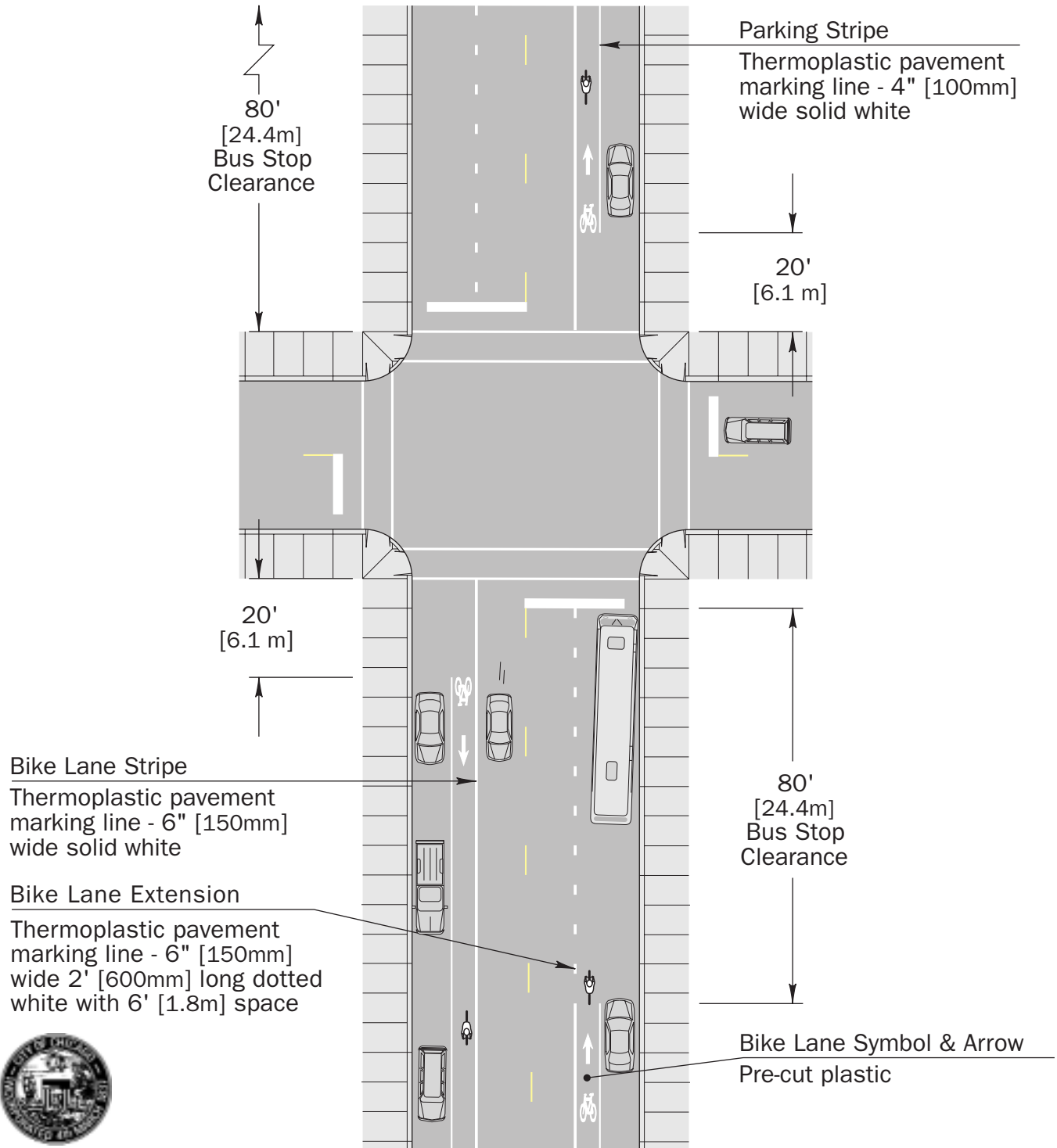

City of Chicago
Richard M. Daley, Mayor

DEPARTMENT OF TRANSPORTATION
Miguel d'Escoto, Commissioner

BUREAU OF TRAFFIC
Donald Grabowski, Deputy Commissioner

CITY OF CHICAGO			
Bus Stop, Non-channelized			
REVISED	5-16-02	SCALE	1"=30'
H:\Bike Lanes\Design Manual\Bus Stops\BSatNonChannel.fh8			No. ___ of ___

Bike Lane with Bus Stop Far Side of Non-Channelized Intersection

Bike Lane Stripe

Thermoplastic pavement marking line - 6" [150mm] wide solid white

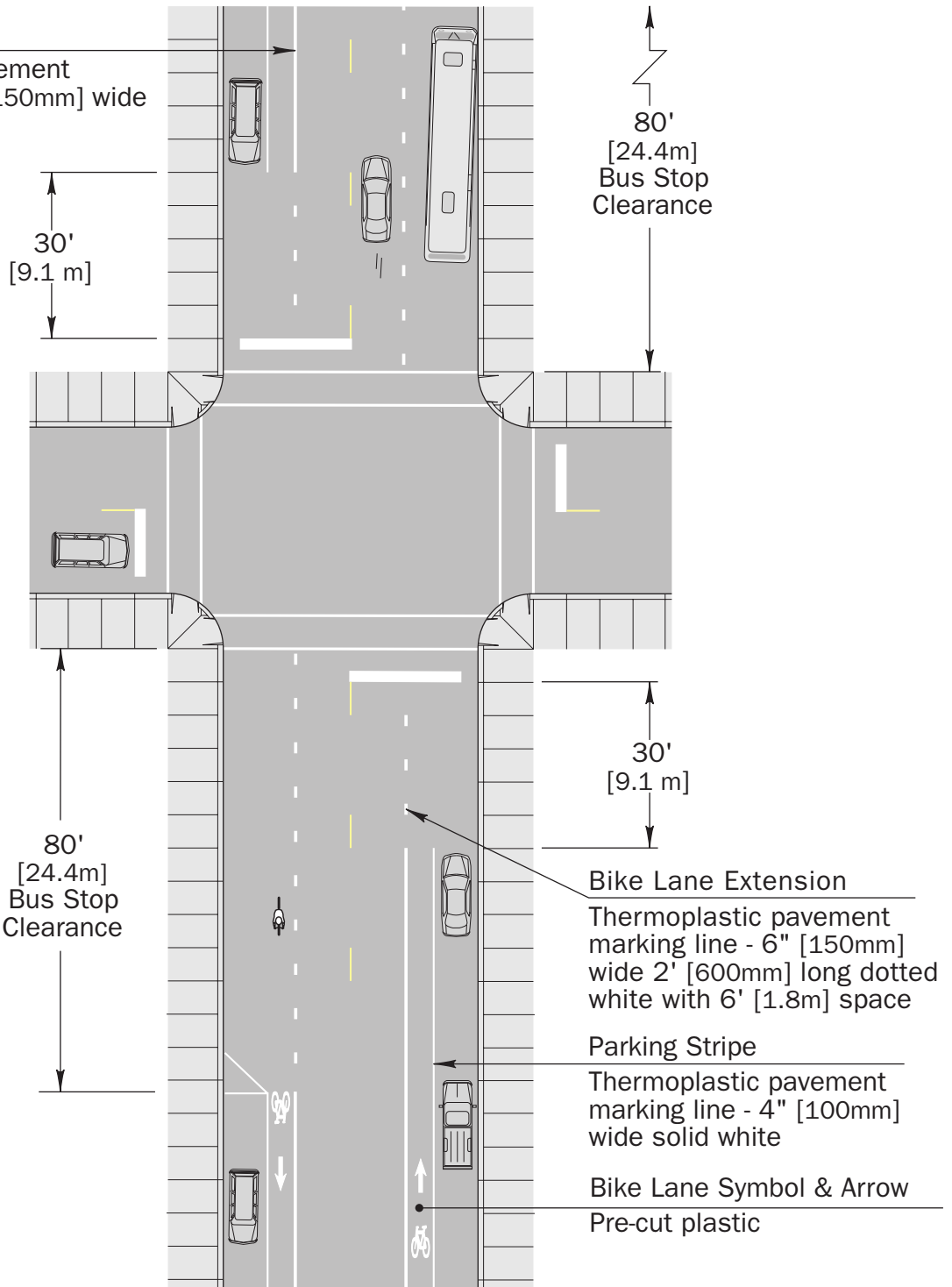

80'
[24.4m]
Bus Stop
Clearance

30'
[9.1 m]

80'
[24.4m]
Bus Stop
Clearance

30'
[9.1 m]

Bike Lane Extension

Thermoplastic pavement marking line - 6" [150mm] wide 2' [600mm] long dotted white with 6' [1.8m] space

Parking Stripe

Thermoplastic pavement marking line - 4" [100mm] wide solid white

Bike Lane Symbol & Arrow

Pre-cut plastic



City of Chicago
Richard M. Daley, Mayor

DEPARTMENT OF TRANSPORTATION
Miguel d'Escoto, Commissioner

BUREAU OF TRAFFIC
Donald Grabowski, Deputy Commissioner

C I T Y O F C H I C A G O

Bus Stop, Far Side Non-Channelized

REVISED 5-16-02

SCALE 1"=30'

H:\Bike Lanes\Design Manual\Bus Stops\BSatNonChannel.fh8

No. ___ of ___

Bike Lane at Mid-Block Bus Stop

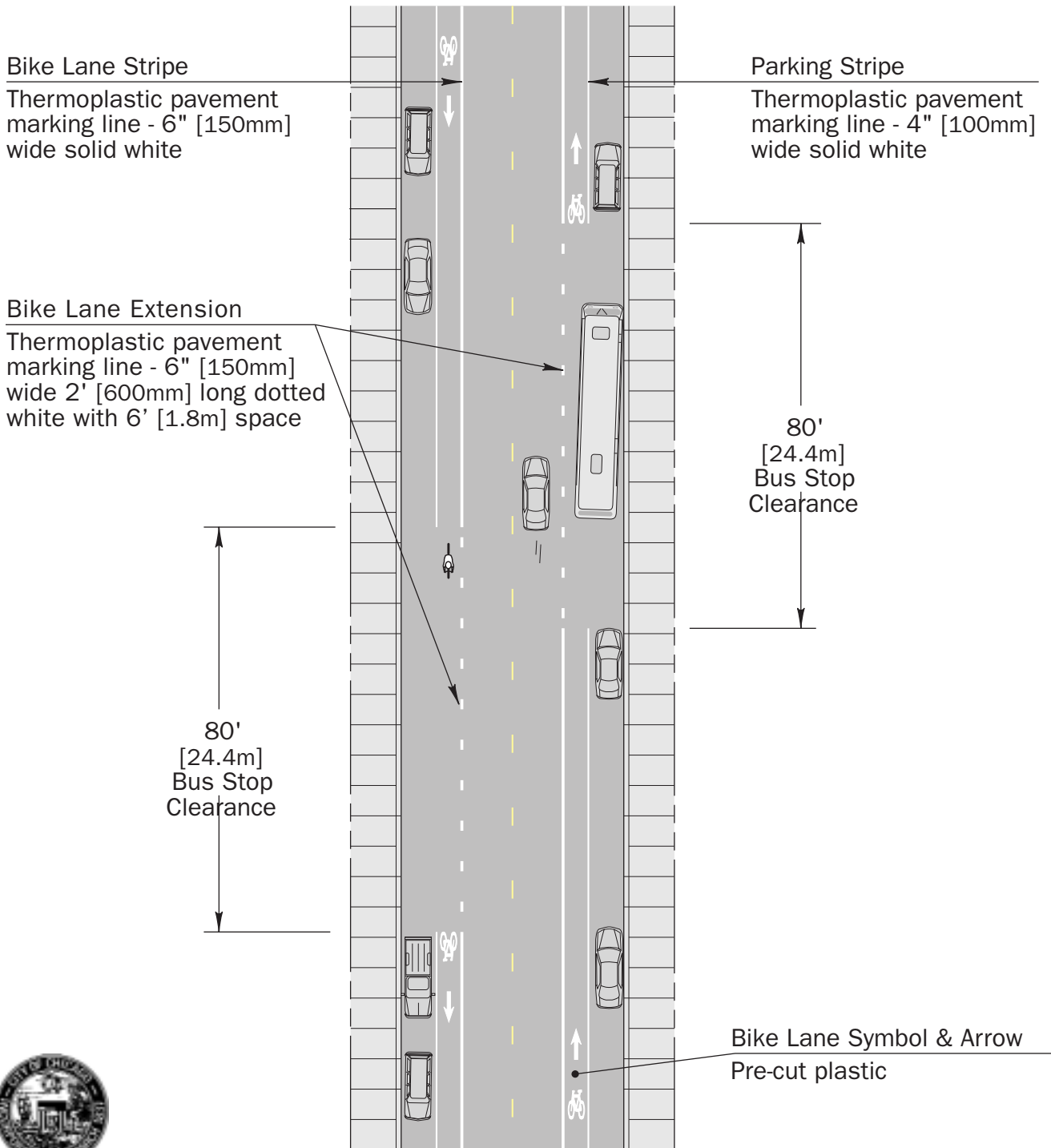

City of Chicago
Richard M. Daley, Mayor

DEPARTMENT OF TRANSPORTATION
Miguel d'Escoto, Commissioner

BUREAU OF TRAFFIC
Donald Grabowski, Deputy Commissioner

CITY OF CHICAGO			
Bus Stop, T-intersection			
REVISED	5-16-02	SCALE	1"=30'
H:\Traffic\Bike Lanes\Design Manual\Bus Stops\Mid_block.fh8			No. __ of __

Bike Lane with Bus Stop T-Intersection

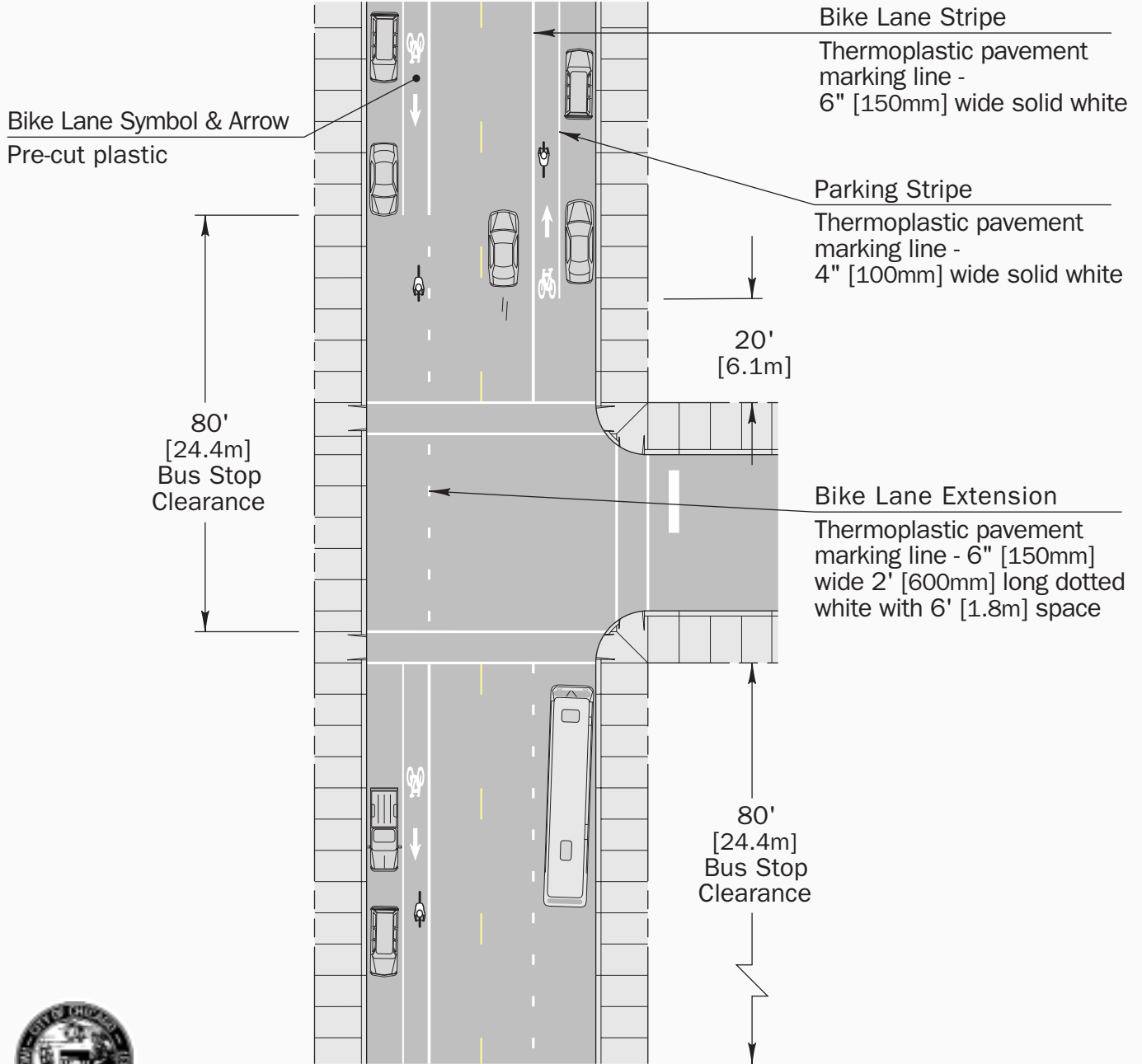

City of Chicago
Richard M. Daley, Mayor

DEPARTMENT OF TRANSPORTATION
Miguel d'Escoto, Commissioner

BUREAU OF TRAFFIC
Donald Grabowski, Deputy Commissioner

CITY OF CHICAGO			
Bus Stop, T-Intersection			
REVISED	5-16-02	SCALE	1"=30'
H:\Traffic\Bike Lanes\David\Bike Lane Specs Manual\T-intersections\local T with bus stop.th9			No. ___ of ___

Bike Lane Symbol Detail

Pavement Marking Type:
3M™ Stamark™ Series
L420 or equivalent White.

Installation Guidelines:

- Air temperature 60°F (15°C) and rising.
- Pavement temperature 70°F (21°C) and rising.
- Overnight temperatures not below 40°F (4°C)
- No rainfall should occur within 24 hours prior to application.

Adhesive:

The use of 3M™ Stamark™ Contact Cement E-44T or equivalent is required on all surfaces. Allow time for primer to dry before applying symbol.

Tamping:

Symbol markings must be tamped three times back and forth (six passes) over each part of the tape with a tamper cart carrying 200 lb. (90kg) of weight. Start in the center and work your way to the edges of the marking to remove any trapped air.

Note: Must be installed in conjunction with Bike Lane Arrow

See **Bike Lane Symbol & Arrow Spacing Detail** for spacing

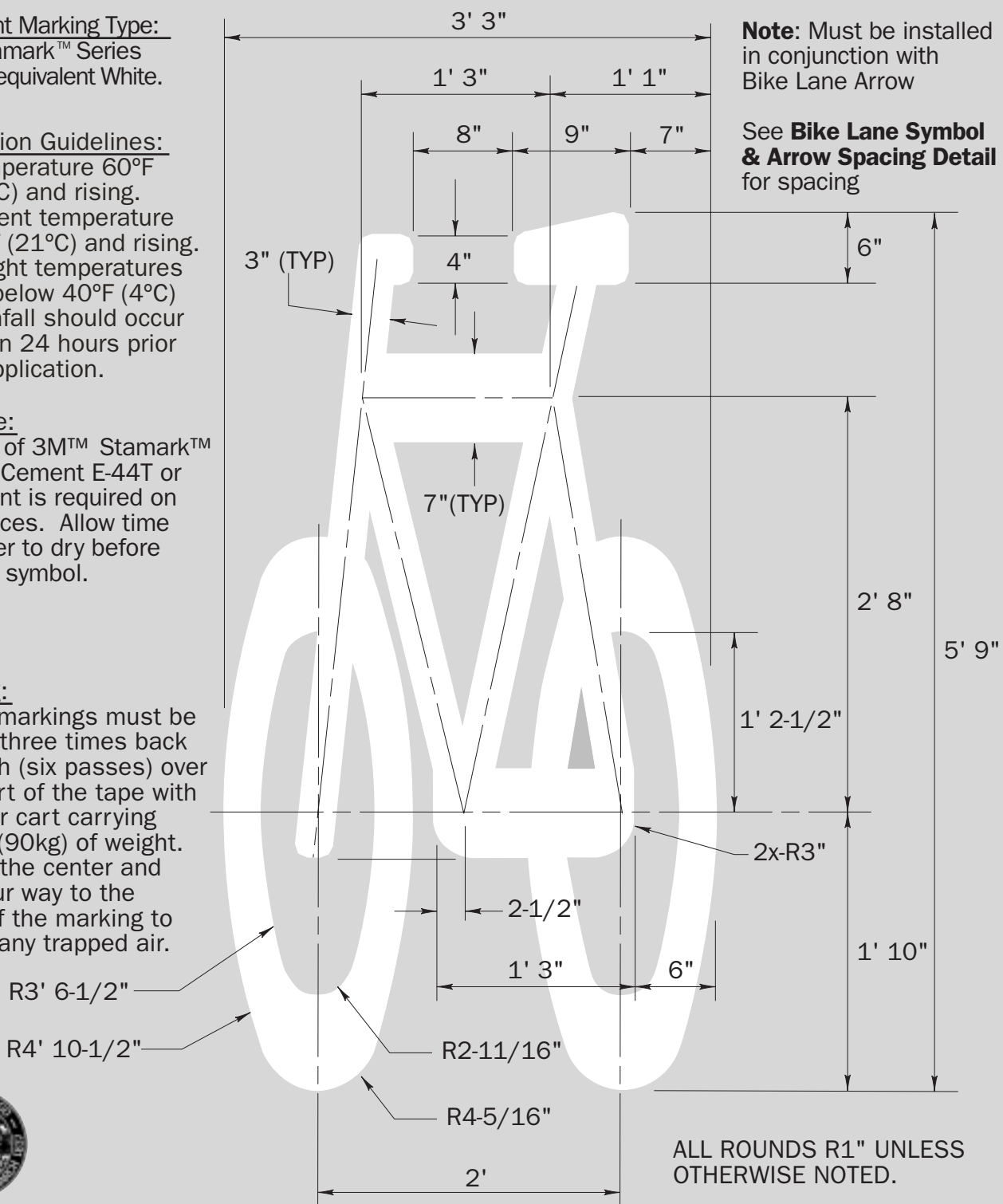

ALL ROUNDS R1" UNLESS OTHERWISE NOTED.



City of Chicago
Richard M. Daley, Mayor

DEPARTMENT OF TRANSPORTATION
Miguel d'Escoto, Commissioner

BUREAU OF TRAFFIC
Donald Grabowski, Deputy Commissioner

CITY OF CHICAGO	
Bike Lane Symbol Detail	
REVISED 5-16-02	SCALE 1" = 1'
H:\Traffic\Bike Lanes\Design Manual\Symbols\Bike Symbol.fh8	No. ___ of ___

Bike Lane Arrow Detail

Pavement Marking Type:
 3M™ Stamark™ Series
 L420 or equivalent White.

- Installation Guidelines:
- Air temperature 60°F (15°C) and rising.
 - Pavement temperature 70°F (21°C) and rising.
 - Overnight temperatures not below 40°F (4°C)
 - No rainfall should occur within 24 hours prior to application.

Adhesive:
 The use of 3M™ Stamark™ Contact Cement E-44T or equivalent is required on all surfaces. Allow time for primer to dry before applying symbol.

Tamping:
 Symbol markings must be tamped three times back and forth (six passes) over each part of the tape with a tamper cart carrying 200 lb. (90kg) of weight. Start in the center and work your way to the edges of the marking to remove any trapped air.

Note: Must be installed in conjunction with Bike Lane Symbol

See **Bike Lane Symbol & Arrow Spacing Detail** for spacing

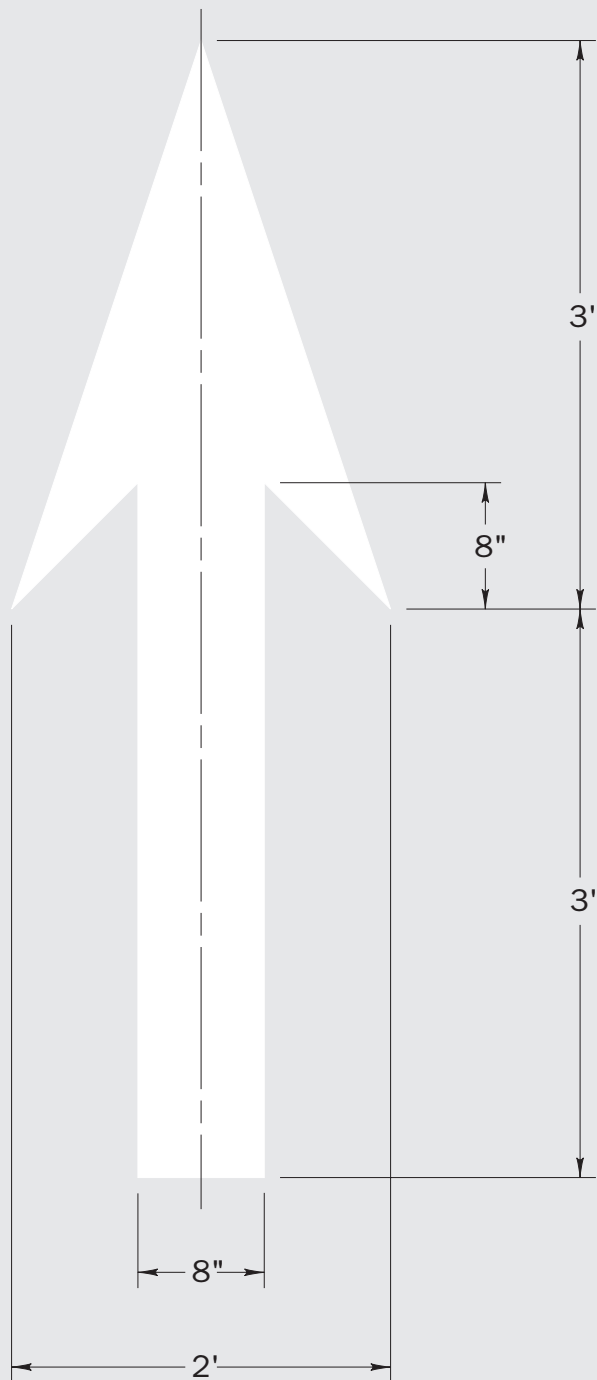

City of Chicago
 Richard M. Daley, Mayor

DEPARTMENT OF TRANSPORTATION
 Miguel d'Escoto, Commissioner

BUREAU OF TRAFFIC
 Donald Grabowski, Deputy Commissioner

CITY OF CHICAGO			
Bike Lane Arrow Detail			
REVISED	5-16-02	SCALE	1" = 1'
H:\Bike Lanes\Design Manual\Symbols\Bike arrow.fh8			No. ___ of ___

Bike Lane Symbol & Arrow Spacing

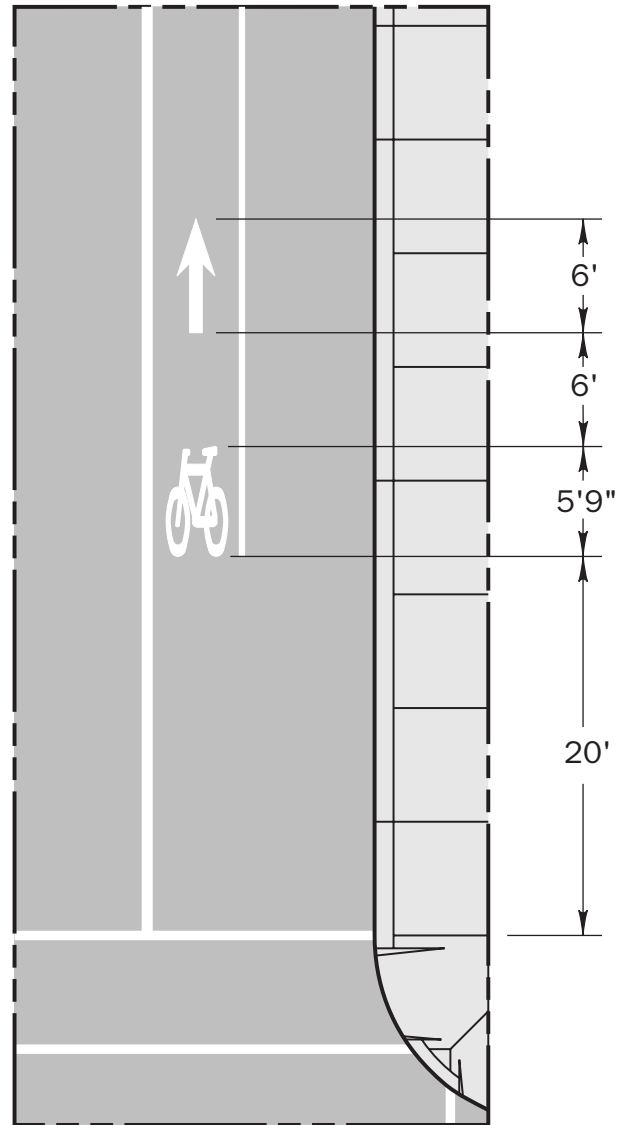
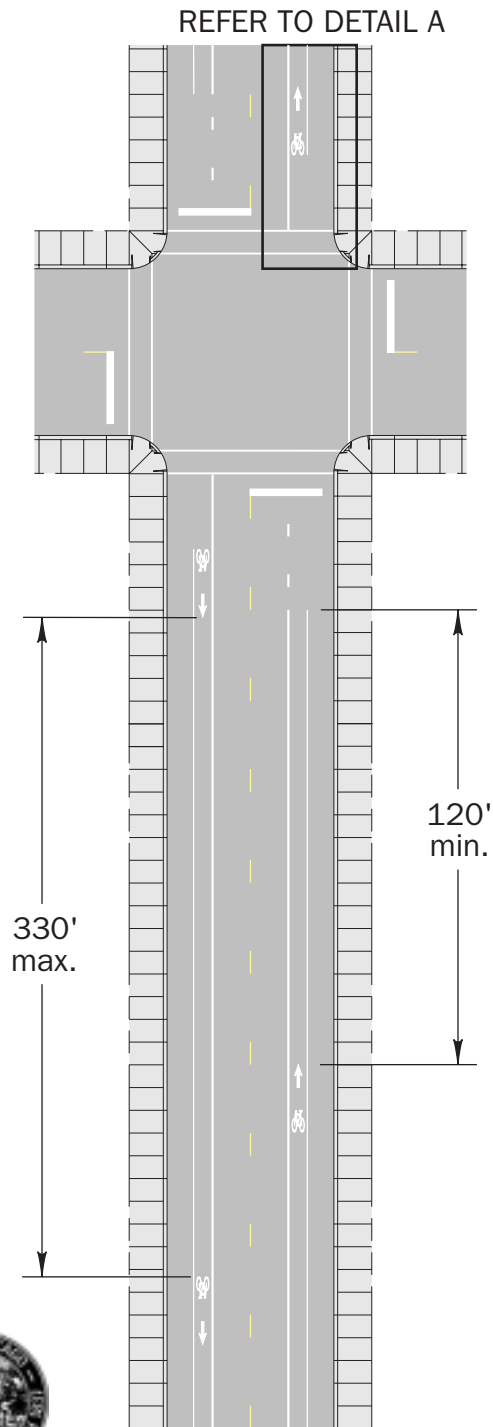

DETAIL A
SCALE 1"=10'



City of Chicago
Richard M. Daley, Mayor

DEPARTMENT OF TRANSPORTATION
Miguel d'Escoto, Commissioner

BUREAU OF TRAFFIC
Donald Grabowski, Deputy Commissioner

C I T Y O F C H I C A G O

Bike Lane Symbol & Arrow Spacing

REVISED	5-16-02	SCALE	1"=50'
---------	---------	-------	--------

H:\Traffic\Bike Lanes\Design Manual\Symbols\Symbol & Arrow Spacing.fh8	No. ___ of ___
--	----------------

Diagonal Striping Detail

Parking Stripe

Thermoplastic pavement marking line - 4" [100mm] wide solid white

End Line

Thermoplastic pavement marking line - 8" [200mm] wide solid white

Diagonal Line

Thermoplastic pavement marking line - 12" [300mm] wide solid white diagonal on 6' [1.8m] centers

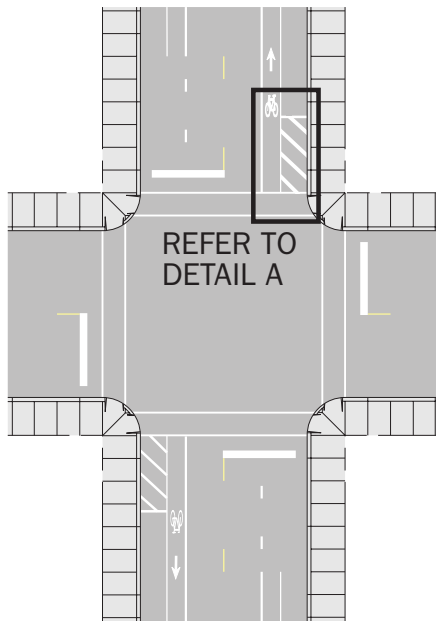
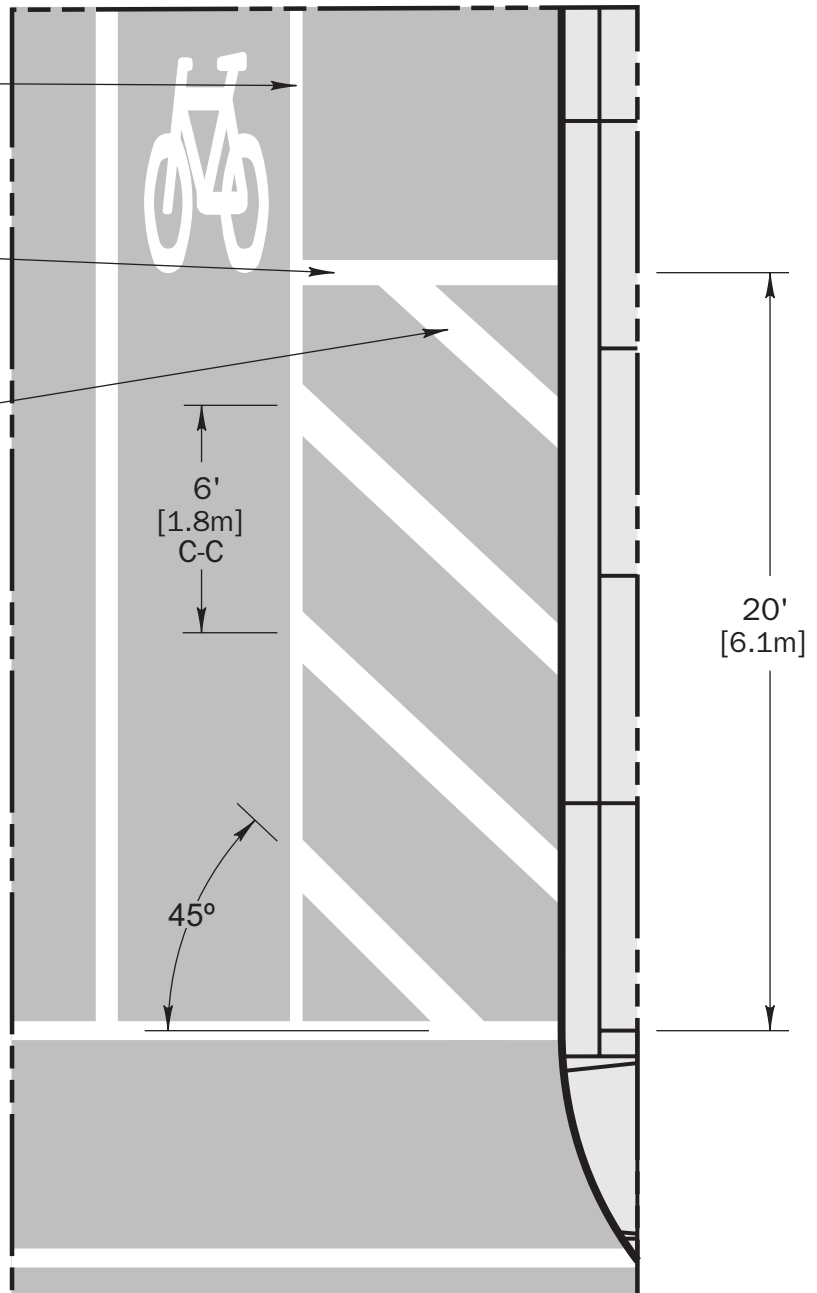

DETAIL A
SCALE 1"=5'



City of Chicago
Richard M. Daley, Mayor

DEPARTMENT OF TRANSPORTATION
Miguel d'Escoto, Commissioner

BUREAU OF TRAFFIC
Donald Grabowski, Deputy Commissioner

CITY OF CHICAGO			
Diagonal Striping Detail			
REVISED	5-16-02	SCALE	1"=50'
H:\Traffic\Bike Lanes\David\Bike Lane Specs Manual\Symbols\Diagonal Striping Detail.fh8			No. ___ of ___

Standard Sign Lane Ahead

Sign Type

Number: R3-16

Size: 24" x 30"

Color: Black on White

Reflective

Type: 2 3/4" Highway Gothic

Symbol: 13" x 7 1/2"

Note: Must be installed in conjunction with **Lane Ends** signs.

Signs must be installed according to the Chicago Department of Transportation's sign hanging standards and at the direction of the resident engineer.



City of Chicago
Richard M. Daley, Mayor

DEPARTMENT OF TRANSPORTATION
Miguel d'Escoto, Commissioner

BUREAU OF TRAFFIC
Donald Grabowski, Deputy Commissioner

C I T Y O F C H I C A G O			
Lane Ahead			
REVISED	10-8-02	SCALE	1" = 6"
H:\Bike Lanes\Design Manual\Signs\lane ahead.FH9			No. ___ of ___

Standard Sign Lane Ends

Sign Type

Number: R3-16a

Size: 24"x 30"

Color: Black on White

Reflective

Type: 2 3/4" Highway Gothic

Symbol: 13" x 7 1/2"

Note: Must be installed in conjunction with **Lane Ahead** signs.

Signs must be installed according to the Chicago Department of Transportation's sign hanging standards and at the direction of the resident engineer.



City of Chicago
Richard M. Daley, Mayor

DEPARTMENT OF TRANSPORTATION
Miguel d'Escoto, Commissioner

BUREAU OF TRAFFIC
Donald Grabowski, Deputy Commissioner

CITY OF CHICAGO			
Lane Ends			
REVISED	10-8-02	SCALE	1" = 6"
H:\Bike Lanes\Design Manual\Signs\lane ends.FH9			No. ___ of ___

Standard Sign

Right Lane Bike Only

Sign Type

Number: R3-17

Size: 24" x 30"

Color: Black on White
Reflective

Font: 2 3/4" Highway Gothic

Symbol: 10 1/2" x 6 1/2"

Note: Must be installed in conjunction with **Bike Lane Ahead** and **Bike Lane Ends** signs.

Signs must be installed according to the Chicago Department of Transportation's sign hanging standards and at the direction of the resident engineer.



City of Chicago
Richard M. Daley, Mayor

DEPARTMENT OF TRANSPORTATION
Miguel d'Escoto, Commissioner

BUREAU OF TRAFFIC
Donald Grabowski, Deputy Commissioner

C I T Y O F C H I C A G O			
Right Lane Bike Only			
REVISED	10-8-02	SCALE	1" = 6"
H:\Bike Lanes\Design Manual\Signs\right lane.FH9			No. ___ of ___

Standard Sign

Right-Turn Only Except Bikes

Sign Type

Number: Special #2

Size: 24" x 30"

Color: Black on White
Reflective

Type: Highway Gothic

ONLY: 4"

EXCEPT: 2 3/4"

Symbol: 6" x 10 1/5"

Note: Must be installed in conjunction with **Shared Lane Yield to Bikes** signs at all right-turn only lanes.

Signs must be installed according to the Chicago Department of Transportation's sign hanging standards and at the direction of the resident engineer.



City of Chicago
Richard M. Daley, Mayor

DEPARTMENT OF TRANSPORTATION
Miguel d'Escoto, Commissioner

BUREAU OF TRAFFIC
Donald Grabowski, Deputy Commissioner

C I T Y O F C H I C A G O

Right-turn Only Except Bikes

REVISED 5-16 -02

SCALE 1" = 6"

H:\Bike Lanes\Design Manual\Signs\only except.FH9

No. ___ of ___

Standard Sign Right-Turn Only Except Bikes and Buses

Sign Type

Number: Special #3

Size: 24" x 30"

Color: Black on White
Reflective

Type: Highway Gothic
ONLY: 4"

EXCEPT: 2 3/4"

Symbol: 6" x 10 1/5"

Note: Must be installed in conjunction with **Shared Lane Yield to Bikes** signs at all right-turn only lanes with bus stops.

Signs must be installed according to the Chicago Department of Transportation's sign hanging standards and at the direction of the resident engineer.



City of Chicago
Richard M. Daley, Mayor

DEPARTMENT OF TRANSPORTATION
Miguel d'Escoto, Commissioner

BUREAU OF TRAFFIC
Donald Grabowski, Deputy Commissioner

C I T Y O F C H I C A G O

Right-turn Only Except Bikes

REVISED 5-16-02

SCALE 1" = 6"

H:\Bike Lanes\Design Manual\Signs\only except bus.FH9

No. ___ of ___

Standard Sign

Shared Lane Yield to Bikes

Sign Type

Number: Special #1
 Size: 24" x 24"
 Color: Black on Yellow Reflective
 Font: 2 3/4" Highway Gothic
 Symbol: 13" x 7 1/2"

Note: Must be installed at the beginning of shared lane at point where bike lane striping ends.

Signs must be installed according to the Chicago Department of Transportation's sign hanging standards and at the direction of the resident engineer.



City of Chicago
Richard M. Daley, Mayor

DEPARTMENT OF TRANSPORTATION
Miguel d'Escoto, Commissioner

BUREAU OF TRAFFIC
Donald Grabowski, Deputy Commissioner

C I T Y O F C H I C A G O			
Shared Lane Yield to Bikes			
REVISED	5-16-02	SCALE	1" = 6"
H:\Bike Lanes\Design Manual\Signs\shared lane.FH9			No. ___ of ___

Standard Sign

Bike Lane at Intersection

Sign Type

Number: Special

Size: 30"x30"

Color: Black on White

Reflective

Type: 5" Highway Gothic

Symbol: 10" x 6 1/2"

Note: Must be installed at intersections where bike lane continues to stop bar to the left of the right-turn only lane.



Signs must be installed according to the Chicago Department of Transportation's sign hanging standards and at the direction of the resident engineer.



City of Chicago
Richard M. Daley, Mayor

DEPARTMENT OF TRANSPORTATION
Miguel d'Escoto, Commissioner

BUREAU OF TRAFFIC
Donald Grabowski, Deputy Commissioner

CITY OF CHICAGO			
Bike Lane at Intersection			
REVISED	3-28-02	SCALE	1" = 6"
H:\Bike Lanes\Design Manual\Symbols\bike lane intersect.fh8			No. ___ of ___

Typical Bike Lane Signage

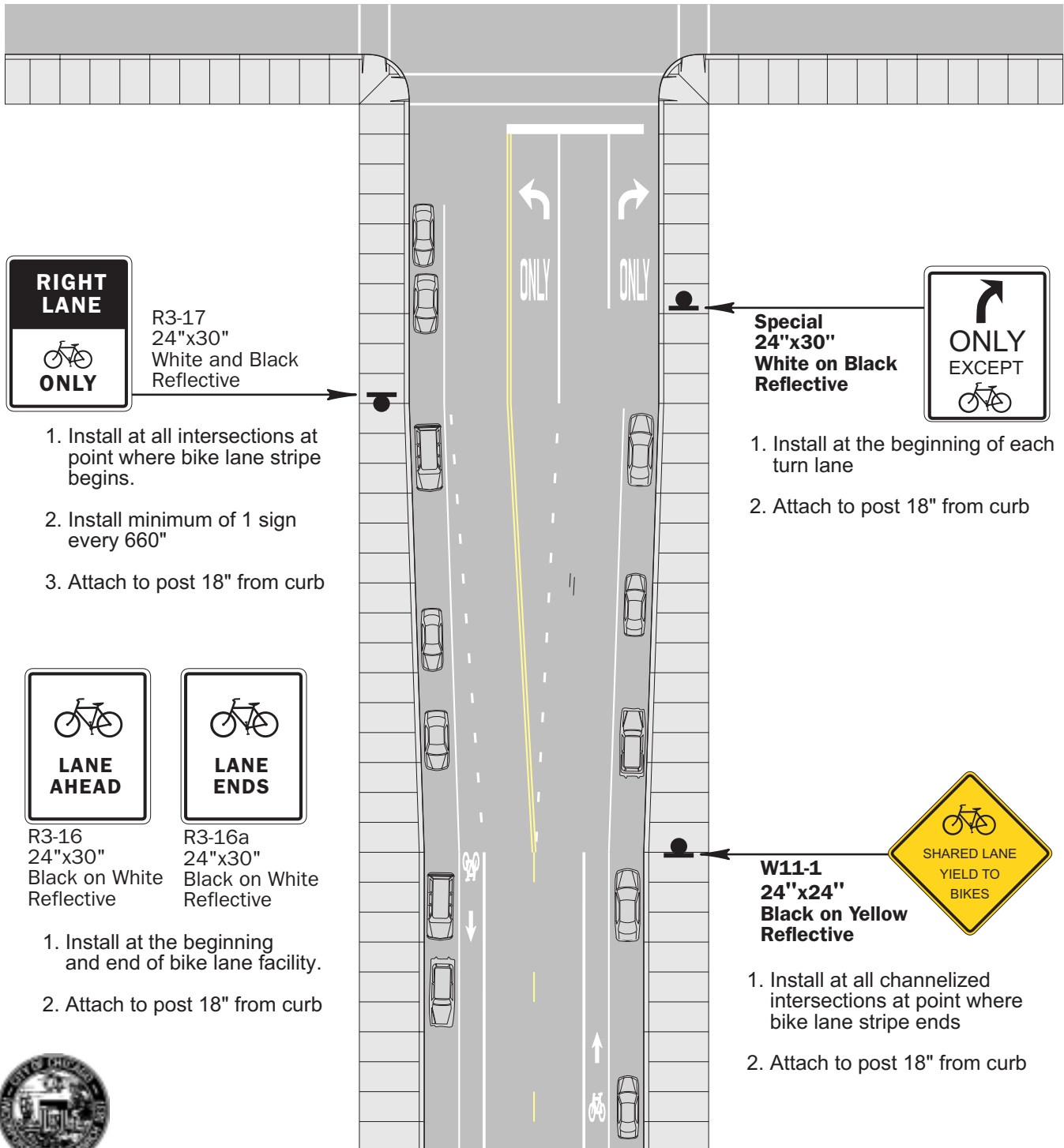

R3-17
24"x30"
White and Black
Reflective

1. Install at all intersections at point where bike lane stripe begins.
2. Install minimum of 1 sign every 660"
3. Attach to post 18" from curb



R3-16
24"x30"
Black on White
Reflective



R3-16a
24"x30"
Black on White
Reflective

1. Install at the beginning and end of bike lane facility.
2. Attach to post 18" from curb



Special
24"x30"
White on Black
Reflective

1. Install at the beginning of each turn lane
2. Attach to post 18" from curb



W11-1
24"x24"
Black on Yellow
Reflective

1. Install at all channelized intersections at point where bike lane stripe ends
2. Attach to post 18" from curb



City of Chicago
Richard M. Daley, Mayor
DEPARTMENT OF TRANSPORTATION
Miguel d'Escoto, Commissioner
BUREAU OF TRAFFIC
Donald Grabowski, Deputy Commissioner

CITY OF CHICAGO			
Typical Bike Lane Signage			
REVISED	5-16-02	SCALE	1"=30'
H:\Bike Lanes\Design Manual\Typical Signage			No. ___ of ___

Frequently Asked Bike Lane Questions and Appropriate Responses

What is a bike lane and who is permitted to use them?

Bicycle-or bike-lanes are marked lanes in the public right-of-way that are for use by bicyclists. Bike lanes are usually striped with a 6" stripe separating the bike lane from the vehicle travel lane, and a 4" stripe separating the bike lane from the parking lane. If there no on-street parking, then the bike lane is against the curb and no 4" stripe is necessary.

Bike lanes are marked with a bike symbol and arrow indicating the direction of travel.

Motorists are not allowed to travel or park in the bike lanes and are subject to a fine if they do so. They are allowed to cross the lanes when turning or when entering or exiting a legal parking space.

Can bicyclists still use the roadway where there is a bike lane?

Cyclists are still permitted to travel in the regular vehicle travel lanes even when a bike lane is present. When making a left turn, a bicyclist is expected to make the turn from the left lane and not the bike lane. Cyclists should signal and make sure it is clear before moving into the vehicle travel lane. Motorists should always be aware that cyclists may merge to avoid an obstacle in the bicycle lane or may need to move to the appropriate lane to make a left hand turn.

This street seems too narrow for a bike lane.

There is limited space on most streets in most urban areas in the US. Transportation agencies must work with their transit partners and local community groups to develop a design standard that safely accommodates cars, bikes, and buses on streets as narrow as 44' wide. The City of Chicago, for instance, has determined that bicycle lanes work well on 44' wide streets. If the street is less than 44' wide, even if it is good street for bicycling, the street is too narrow to stripe bike lanes. On those streets narrower than 44' wide that are recommended for bicycle travel, most agencies will post special signs that indicate the street is a designated bike route, but would not use any pavement markings.

Striping both sides of a bike lane is important in areas with relatively low levels of parking—the stripe helps ensure motorists do not use the space as a through travel lane.

Why put bicyclists on the street; why not on sidewalks or bikepaths?

Sidewalks are for pedestrians. Bicycle use on sidewalks with high numbers of pedestrians results in crashes and injuries for both bicyclists and pedestrians.

In most cases, the street is the safest place for bicyclists to ride in the city. National studies have shown that riding on the sidewalk (and especially when riding against traffic in the wrong direction) is a significant contributor to car/bike collisions because the motorist is not looking for a relatively fast moving vehicle on the sidewalk.

Bicycles are legal vehicles and bicyclists have the same rights and responsibilities as motorists when traveling on the street. Many cities prohibit persons 12 years and older from riding on the sidewalk unless it is specifically posted for bicycle use.

Bicycle paths (trails or shared use paths) are good facilities for some trips, but have limited usefulness for most trips throughout the city.

Bike lanes encourage bicyclists to use the street as opposed to the sidewalk, which eases congestion and improves safety on the sidewalks.

Streets by their very nature serve the bicyclist in the same way they serve every other user: they get people where they want to go. The street system is already in place and streets provide access to virtually all destinations: homes, businesses, shops, schools, churches, parks, etc. There is not enough space or money to create separated bike paths all over the city.

Why are bike lanes usually on the arterial streets? Why not put more lanes on the side streets.

Several criteria are used when determining which streets to put bike lanes on: Direct streets, streets with relatively low traffic speeds and volumes, and streets that have controlled (stop signs or stop lights) intersections. Quieter residential or side streets are great streets to ride on but can be dangerous when they cross big streets that do not have a controlled intersection and they therefore are not good candidates for bike lanes. Arterial streets offer directness and access to most destination, therefore they are popular choices for getting around. Bike lanes on arterial streets offer cyclists the assistance they need when in busier conditions.

There is too much traffic on the street to establish a bike lane.

Bicycle lanes have been successfully implemented on streets with upwards of 30,000 vehicles per day.



Bicycle lanes, such as on Halstead, have been shown to better regulate both motorists and bicyclists.



What happens to the car parking?

In many cases, on-street parking is not affected by installing bike lanes. The bike lane is striped between the parking lane and the motor vehicle travel lane. In some isolated instances, one or two parking spaces may be lost near an intersection to provide proper alignment and sight distances.

Will the bike lane cause traffic jams?

Traffic jams result from too many cars trying to use the same space on streets. Bike lanes use only 5 feet of lane space—not enough to carry a motor vehicle. And bikes are twenty times as space-efficient as autos. Bike lanes can actually alleviate congestion. When some drivers choose to bike instead of drive, additional road space is freed up and everybody wins.

Will bike lanes slow down traffic?

Bike lanes have been shown to reduce the speeds of motor vehicles in adjacent lanes by about 5 miles per hour. This usually benefits most urban streets because they work best when cars are traveling between 25 and 35 miles per hour. Overall travel times on streets with bike lanes usually remain the same. Bike lanes help to calm and organize the traffic. That means fewer accidents. That's because bike lanes help create a buffer zone at the edge of the traffic lane. This buffer improves safety for people entering or exiting their parked cars and makes it easier for drivers to see children about to enter the roadway—giving them more time to react.

What happens at the intersections?

At intersection approaches, the bike lane striping is usually dashed to indicate that motorists may be entering and crossing the bike lane to make a right hand turn. There are pavement markings and signs to indicate this. Where there is not adequate width to stripe the bike lane up to the intersection approach, the curbside lane should be signed as a shared-use lane. In some cases use of the shared-use lane is restricted to buses, bikes and right turns.

Would it be possible to include some assistance for the cyclists through the big intersections, like the six-way intersections?

Generally, in the U.S., pavement markings are not continued through an intersection because they are difficult to maintain. There may be some intersections where high levels of bike use and safety issues would warrant consideration of marking the bike lane through the intersection.

Is the bike lane necessary?

Arterial streets are very popular streets for bicycling because of the mix of commercial, residential and institutional land uses they serve. Small segments of bike lane can provide an opportunity for someone to ride their bike when they might otherwise not.

Chicago DOT and Chicagoland Bicycle Federation staff celebrate the opening of the bike lanes on Damen.



How long will the bike lane markings last?

Some bike lanes are striped using paint. Paint is not permanent and typically lasts two years. Some bike lanes are striped using Thermoplastic. Thermoplastic lasts longer, about three to five years.

Will the bike lane affect traffic on the street?

No significant impact on traffic operation is anticipated. Bike lanes encourage the safe interaction of bicycles and motor vehicles and can discourage dangerous traffic movements such as weaving and passing on the right. In addition to making the road safer for all current users, studies show that bike lanes can reduce traffic congestion by encouraging people to bicycle instead of drive. Much of the funding for Chicago's bike lane program, for example, is funded through Federal grants to reduce congestion.

What about bus stops, what happens to cyclists there?

Before the intersection, where most bus stops are located, the bike lane is dashed to indicate that the bus can pull across the bike lane and to notify the cyclist that buses will be pulling over. Bikes and buses have to merge just like the buses do with motor vehicle traffic. When a bus is at the bus stop the cyclist should either wait behind the bus or pass on the left. The cyclist should not pass the bus on the right because they would run into people getting off the bus.

Is it a concern that the bike lane does not connect to other bike lanes?

Even if a bike lane won't take you all the way to your final destination, a segment of bike lane will make your trip safer and more enjoyable. Most bike trips in the city involve using a combination of streets with bike lanes and streets without bike lanes. Studies indicate that a little assistance is a big factor in encouraging people to bicycle.

Why doesn't the proposed bike lane continue the whole distance of the street?

There might be sections of the street that are less than 44' wide. Those sections are not wide enough to stripe a bike lane, so they will be signed with bike route signs. Bike lanes are provided where possible.

A bike lane is great but how do you get to the bike lanes?

Bicyclists ride normally in traffic on streets that link to bike lanes. Residential streets are great for getting to and from the bike lane. Most people learn quickly which streets work best for bike riding in their own neighborhood. Many cities provide bike maps and safety information on how to ride safely on streets with and without bike lanes.

Why not make some of the one-way streets, two-way for cyclists?

An increasing number of cities (Chicago, Minneapolis, Portland etc) have streets that are one-way for cars but have been modified to permit two-way bicycle use. When designing these special situations, care must be taken to make sure both cyclists and motorists know where they should operate and what traffic to expect along the street and at intersections.

Bike lanes give a false sense of security. Cars pass in the bike lane, they park in the bike lane, where is the enforcement for automobiles?

On most streets with consistent on-street parking, using the bike lane illegally as a passing lane is not a problem. It becomes a problem when there are longer stretches with an empty parking lane. Double parking is a barrier bicyclists face with or without a bike lane. Communities need to work with their local police districts to enforce safe and proper use of the bike lanes.

Why not put the bike lane on the inside of the parked cars?

Putting the bike lane on the curbside of the parked cars does not work very well for two reasons. 1) It causes crashes at intersections and driveways because the motorist is not expecting bikes to emerge from behind parked cars. If the cyclist is moving next to motor traffic, then they have a greater chance of being seen. 2) If the cyclist is riding between the parked car and the curb and there is debris in the road or someone loading their car, then they have no place to move to. With the bike lane on the outside of the parked cars, if the cyclists has to avoid an obstacle, then they can safely merge with traffic and then move back into the bike lane.

A striped bike lane that has added definition by virtue of not being resurfaced with a chip seal coating. Note also that the parking spaces are marked with Ts.



How do you get cyclists to obey the laws?
I never see cyclists stop at stop signs.

All groups (motorists, cyclists, and pedestrians) are human beings and they don't always obey the laws. If you were to go out to a stop sign at any location you would see all of these user groups not behaving correctly. Enforcement needs to be reasonable, design needs to be good, and users need to be educated.

It seems that when you add a bike lane it gives cyclists
permission to ignore traffic lights and stop signs.

Actually the opposite is true. National studies have shown that bike lanes influence positive behavior and improve safety. Well designed facilities encourage proper behavior and decrease the likelihood of crashes. Bike lanes have also been shown to discourage riding on the sidewalk, which is illegal and hazardous for adult bicyclists.

“Bike lanes are not going to solve all the problems on the road. We think that bike lanes can make the street a safer place for both the motorist and the cyclist alike, it is a win/win situation.”

—Lissa Morgan, former Chicago Bike Program consultant

Bike Lane Design Guide

Produced August 2002

Revised October 2002



Production and Design by LEJ Graphics

Special thanks to:

Tom Branigan, P.E. (City of Philadelphia)

Tom Walsh, P.E. (City of Madison, Wisconsin)

David Pelz, P.E. (Retd. City of Davis, California)

for their review and comments.

Available on-line at www.bicyclinginfo.org