

# Accurate Counts

978-664-2565

N/S Street : Route 24 NB Ramps  
 E/W Street : Route 104  
 City/State : Bridgewater, MA  
 Weather : Clear

File Name : 202700B2  
 Site Code : 20270002  
 Start Date : 10/2/2024  
 Page No : 1

### Groups Printed- Cars - Trucks

Start Time	Route 104 From East		Route 24 NB Ramps From South			Route 104 From West		Int. Total
	Left	Thru	Left	Right	Thru	Right		
07:00 AM	87	212	18	142	141	58	658	
07:15 AM	97	282	12	164	100	65	720	
07:30 AM	74	256	8	207	123	81	749	
07:45 AM	94	225	19	191	135	61	725	
<b>Total</b>	<b>352</b>	<b>975</b>	<b>57</b>	<b>704</b>	<b>499</b>	<b>265</b>	<b>2852</b>	
08:00 AM	85	214	21	152	135	58	665	
08:15 AM	73	236	31	180	119	58	697	
08:30 AM	63	184	24	159	110	56	596	
08:45 AM	70	159	23	138	106	37	533	
<b>Total</b>	<b>291</b>	<b>793</b>	<b>99</b>	<b>629</b>	<b>470</b>	<b>209</b>	<b>2491</b>	
<b>Grand Total</b>	<b>643</b>	<b>1768</b>	<b>156</b>	<b>1333</b>	<b>969</b>	<b>474</b>	<b>5343</b>	
Apprch %	26.7	73.3	10.5	89.5	67.2	32.8		
Total %	12	33.1	2.9	24.9	18.1	8.9		
Cars	610	1654	143	1239	930	466	5042	
% Cars	94.9	93.6	91.7	92.9	96	98.3	94.4	
Trucks	33	114	13	94	39	8	301	
% Trucks	5.1	6.4	8.3	7.1	4	1.7	5.6	

Start Time	Route 104 From East			Route 24 NB Ramps From South			Route 104 From West			Int. Total
	Left	Thru	App. Total	Left	Right	App. Total	Thru	Right	App. Total	
Peak Hour Analysis From 07:00 AM to 08:45 AM - Peak 1 of 1										
Peak Hour for Entire Intersection Begins at 07:15 AM										
07:15 AM	<b>97</b>	<b>282</b>	<b>379</b>	12	164	176	100	65	165	720
07:30 AM	74	256	330	8	<b>207</b>	<b>215</b>	123	<b>81</b>	<b>204</b>	<b>749</b>
07:45 AM	94	225	319	19	191	210	<b>135</b>	61	196	725
08:00 AM	85	214	299	<b>21</b>	152	173	135	58	193	665
<b>Total Volume</b>	<b>350</b>	<b>977</b>	<b>1327</b>	<b>60</b>	<b>714</b>	<b>774</b>	<b>493</b>	<b>265</b>	<b>758</b>	<b>2859</b>
% App. Total	26.4	73.6		7.8	92.2		65	35		
PHF	.902	.866	.875	.714	.862	.900	.913	.818	.929	.954
Cars	333	915	1248	53	663	716	484	260	744	2708
% Cars	95.1	93.7	94.0	88.3	92.9	92.5	98.2	98.1	98.2	94.7
Trucks	17	62	79	7	51	58	9	5	14	151
% Trucks	4.9	6.3	6.0	11.7	7.1	7.5	1.8	1.9	1.8	5.3

# Accurate Counts

978-664-2565

N/S Street : Route 24 NB Ramps  
 E/W Street : Route 104  
 City/State : Bridgewater, MA  
 Weather : Clear

File Name : 202700B2  
 Site Code : 20270002  
 Start Date : 10/2/2024  
 Page No : 2

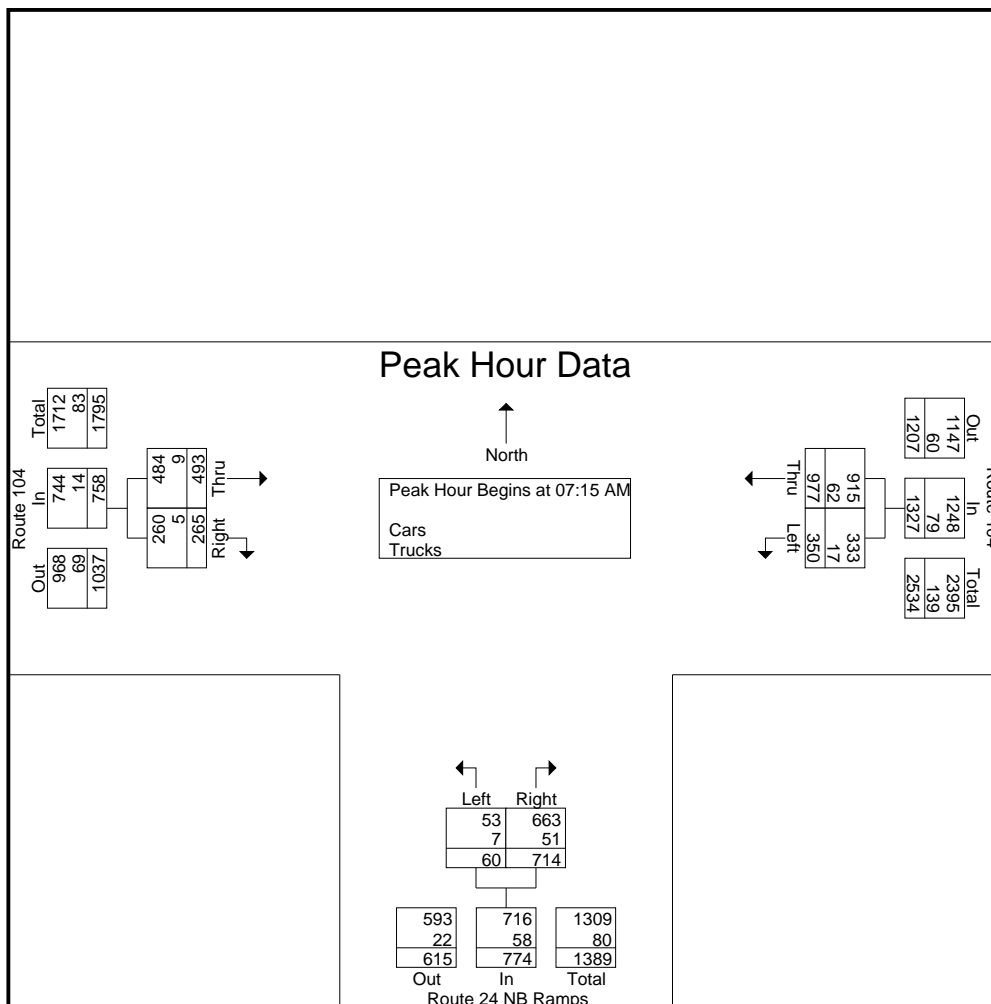

**Peak Hour Analysis From 07:00 AM to 08:45 AM - Peak 1 of 1**

Peak Hour for Each Approach Begins at:

	07:00 AM			07:30 AM			08:00 AM		
+0 mins.	87	212	299	8	207	215	123	81	204
+15 mins.	97	282	379	19	191	210	135	61	196
+30 mins.	74	256	330	21	152	173	135	58	193
+45 mins.	94	225	319	31	180	211	119	58	177
Total Volume	352	975	1327	79	730	809	512	258	770
% App. Total	26.5	73.5		9.8	90.2		66.5	33.5	
PHF	.907	.864	.875	.637	.882	.941	.948	.796	.944
Cars	332	915	1247	73	686	759	500	254	754
% Cars	94.3	93.8	94	92.4	94	93.8	97.7	98.4	97.9
Trucks	20	60	80	6	44	50	12	4	16
% Trucks	5.7	6.2	6	7.6	6	6.2	2.3	1.6	2.1

# Accurate Counts

978-664-2565

File Name : 202700B2

Site Code : 20270002

Start Date : 10/2/2024

Page No : 3

N/S Street : Route 24 NB Ramps

E/W Street : Route 104

City/State : Bridgewater, MA

Weather : Clear

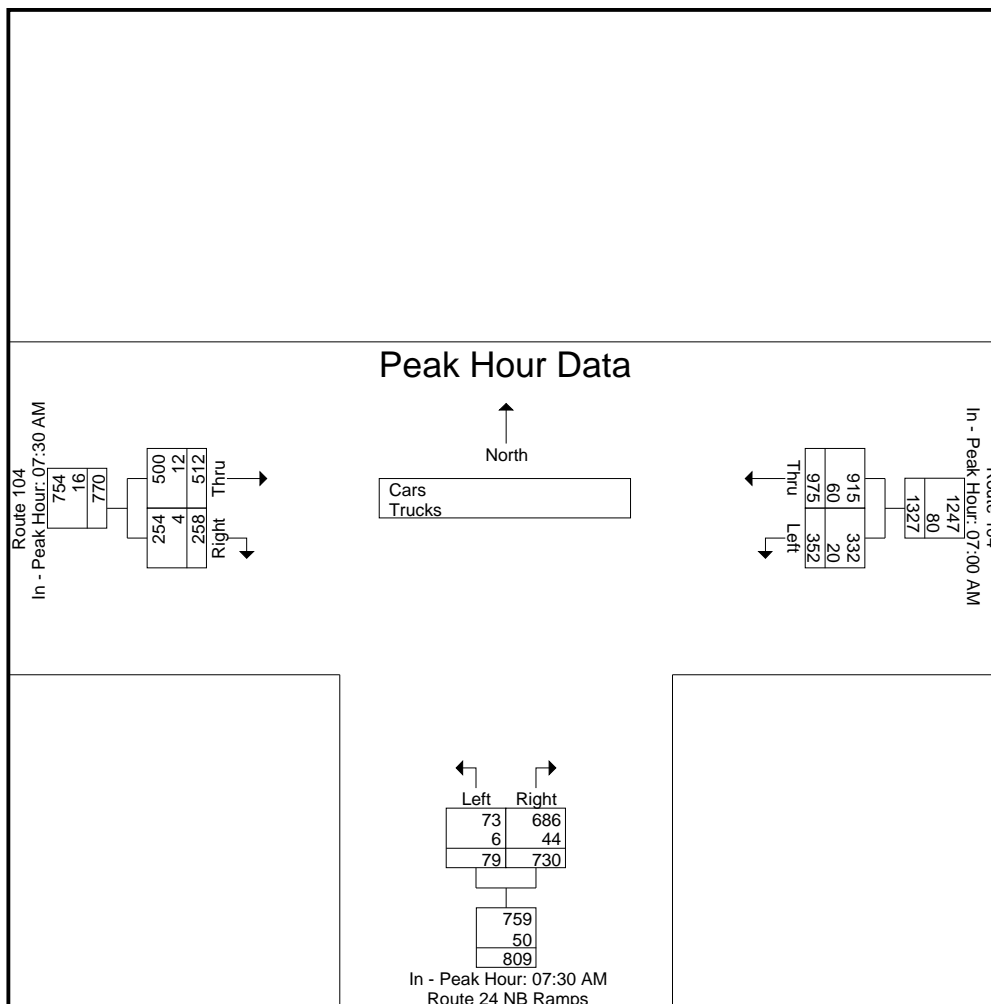

# Accurate Counts

978-664-2565

N/S Street : Route 24 NB Ramps  
 E/W Street : Route 104  
 City/State : Bridgewater, MA  
 Weather : Clear

File Name : 202700B2  
 Site Code : 20270002  
 Start Date : 10/2/2024  
 Page No : 4

## Groups Printed- Cars

Start Time	Route 104 From East		Route 24 NB Ramps From South		Route 104 From West		Int. Total
	Left	Thru	Left	Right	Thru	Right	
07:00 AM	81	201	16	133	129	57	617
07:15 AM	89	269	11	145	97	64	675
07:30 AM	71	235	7	196	123	79	711
07:45 AM	91	210	17	179	131	60	688
<b>Total</b>	<b>332</b>	<b>915</b>	<b>51</b>	<b>653</b>	<b>480</b>	<b>260</b>	<b>2691</b>
08:00 AM	82	201	18	143	133	57	634
08:15 AM	69	222	31	168	113	58	661
08:30 AM	60	167	21	145	102	56	551
08:45 AM	67	149	22	130	102	35	505
<b>Total</b>	<b>278</b>	<b>739</b>	<b>92</b>	<b>586</b>	<b>450</b>	<b>206</b>	<b>2351</b>
<b>Grand Total</b>	<b>610</b>	<b>1654</b>	<b>143</b>	<b>1239</b>	<b>930</b>	<b>466</b>	<b>5042</b>
Apprch %	26.9	73.1	10.3	89.7	66.6	33.4	
Total %	12.1	32.8	2.8	24.6	18.4	9.2	

Start Time	Route 104 From East			Route 24 NB Ramps From South			Route 104 From West			Int. Total
	Left	Thru	App. Total	Left	Right	App. Total	Thru	Right	App. Total	
Peak Hour Analysis From 07:00 AM to 08:45 AM - Peak 1 of 1										
Peak Hour for Entire Intersection Begins at 07:15 AM										
07:15 AM	89	<b>269</b>	<b>358</b>	11	145	156	97	64	161	675
07:30 AM	71	235	306	7	<b>196</b>	<b>203</b>	123	<b>79</b>	<b>202</b>	<b>711</b>
07:45 AM	<b>91</b>	210	301	17	179	196	131	60	191	688
08:00 AM	82	201	283	<b>18</b>	143	161	<b>133</b>	57	190	634
Total Volume	333	915	1248	53	663	716	484	260	744	2708
% App. Total	26.7	73.3		7.4	92.6		65.1	34.9		
PHF	.915	.850	.872	.736	.846	.882	.910	.823	.921	.952

# Accurate Counts

978-664-2565

N/S Street : Route 24 NB Ramps  
 E/W Street : Route 104  
 City/State : Bridgewater, MA  
 Weather : Clear

File Name : 202700B2  
 Site Code : 20270002  
 Start Date : 10/2/2024  
 Page No : 5

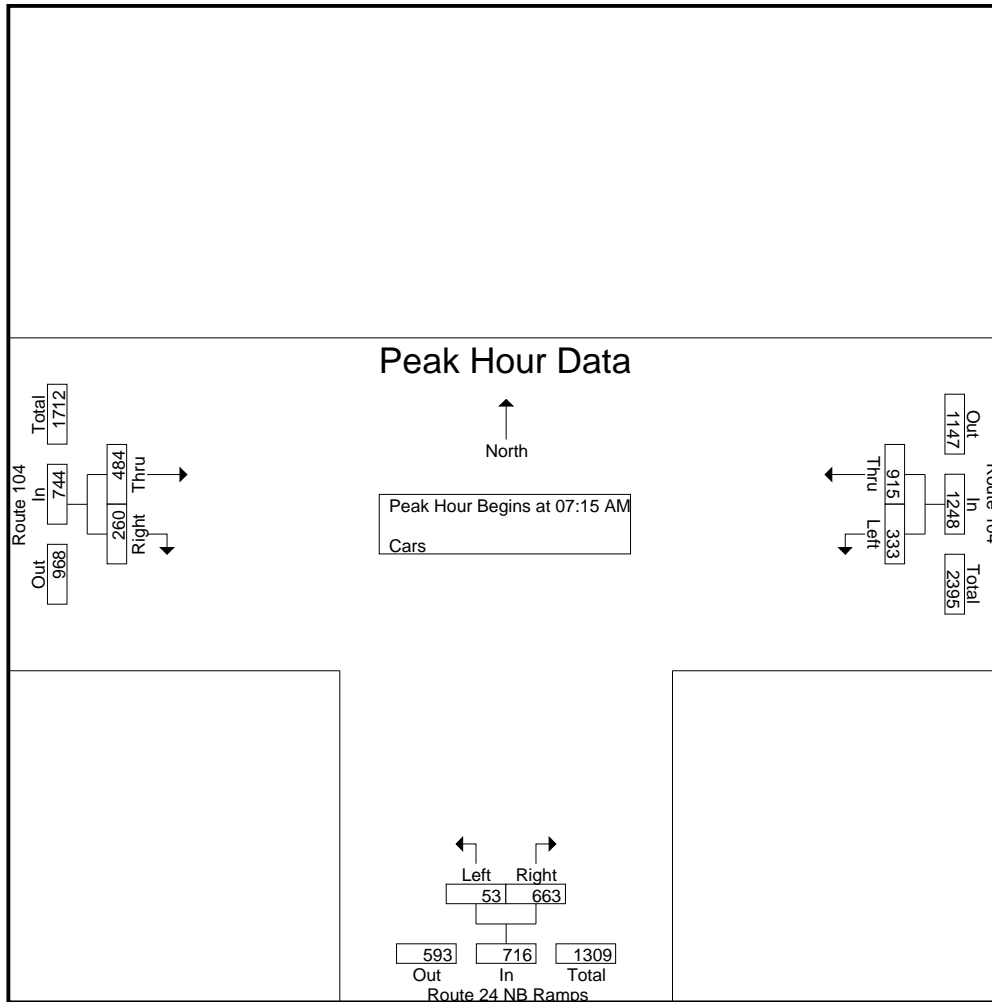

**Peak Hour Analysis From 07:00 AM to 08:45 AM - Peak 1 of 1**

Peak Hour for Each Approach Begins at:

	07:15 AM			07:30 AM			07:30 AM		
+0 mins.	89	<b>269</b>	<b>358</b>	7	<b>196</b>	<b>203</b>	123	<b>79</b>	<b>202</b>
+15 mins.	71	235	306	17	179	196	131	60	191
+30 mins.	<b>91</b>	210	301	18	143	161	<b>133</b>	57	190
+45 mins.	82	201	283	<b>31</b>	168	199	113	58	171
Total Volume	333	915	1248	73	686	759	500	254	754
% App. Total	26.7	73.3		9.6	90.4		66.3	33.7	
PHF	.915	.850	.872	.589	.875	.935	.940	.804	.933

# Accurate Counts

978-664-2565

File Name : 202700B2

Site Code : 20270002

Start Date : 10/2/2024

Page No : 6

N/S Street : Route 24 NB Ramps

E/W Street : Route 104

City/State : Bridgewater, MA

Weather : Clear

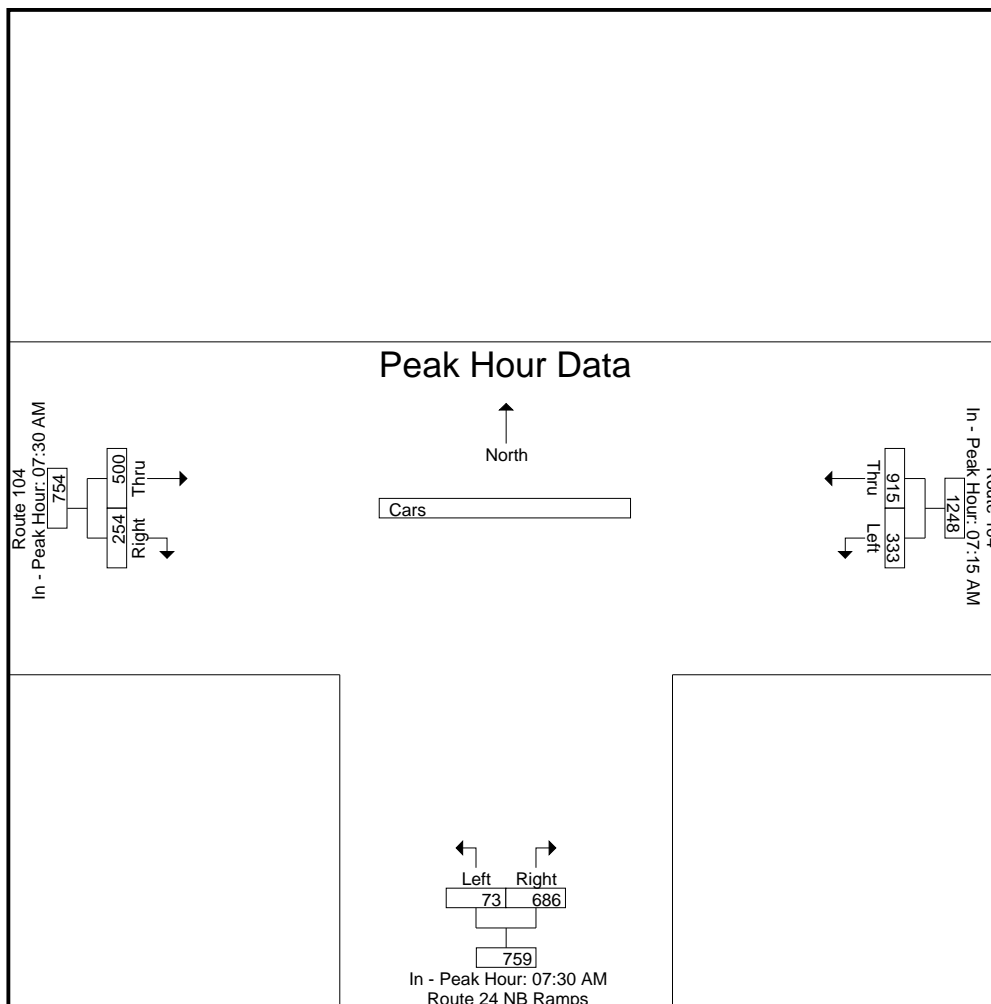

# Accurate Counts

978-664-2565

N/S Street : Route 24 NB Ramps

E/W Street : Route 104

City/State : Bridgewater, MA

Weather : Clear

File Name : 202700B2

Site Code : 20270002

Start Date : 10/2/2024

Page No : 7

### Groups Printed- Trucks

Start Time	Route 104 From East		Route 24 NB Ramps From South		Route 104 From West		Int. Total
	Left	Thru	Left	Right	Thru	Right	
07:00 AM	6	11	2	9	12	1	41
07:15 AM	8	13	1	19	3	1	45
07:30 AM	3	21	1	11	0	2	38
07:45 AM	3	15	2	12	4	1	37
<b>Total</b>	<b>20</b>	<b>60</b>	<b>6</b>	<b>51</b>	<b>19</b>	<b>5</b>	<b>161</b>
08:00 AM	3	13	3	9	2	1	31
08:15 AM	4	14	0	12	6	0	36
08:30 AM	3	17	3	14	8	0	45
08:45 AM	3	10	1	8	4	2	28
<b>Total</b>	<b>13</b>	<b>54</b>	<b>7</b>	<b>43</b>	<b>20</b>	<b>3</b>	<b>140</b>
<b>Grand Total</b>	<b>33</b>	<b>114</b>	<b>13</b>	<b>94</b>	<b>39</b>	<b>8</b>	<b>301</b>
Apprch %	22.4	77.6	12.1	87.9	83	17	
Total %	11	37.9	4.3	31.2	13	2.7	

Start Time	Route 104 From East			Route 24 NB Ramps From South			Route 104 From West			Int. Total
	Left	Thru	App. Total	Left	Right	App. Total	Thru	Right	App. Total	
Peak Hour Analysis From 07:00 AM to 08:45 AM - Peak 1 of 1										
Peak Hour for Entire Intersection Begins at 07:00 AM										
07:00 AM	6	11	17	2	9	11	12	1	13	41
07:15 AM	8	13	21	1	19	20	3	1	4	45
07:30 AM	3	21	24	1	11	12	0	2	2	38
07:45 AM	3	15	18	2	12	14	4	1	5	37
<b>Total Volume</b>	<b>20</b>	<b>60</b>	<b>80</b>	<b>6</b>	<b>51</b>	<b>57</b>	<b>19</b>	<b>5</b>	<b>24</b>	<b>161</b>
% App. Total	25	75		10.5	89.5		79.2	20.8		
PHF	.625	.714	.833	.750	.671	.713	.396	.625	.462	.894

# Accurate Counts

978-664-2565

N/S Street : Route 24 NB Ramps  
 E/W Street : Route 104  
 City/State : Bridgewater, MA  
 Weather : Clear

File Name : 202700B2  
 Site Code : 20270002  
 Start Date : 10/2/2024  
 Page No : 8

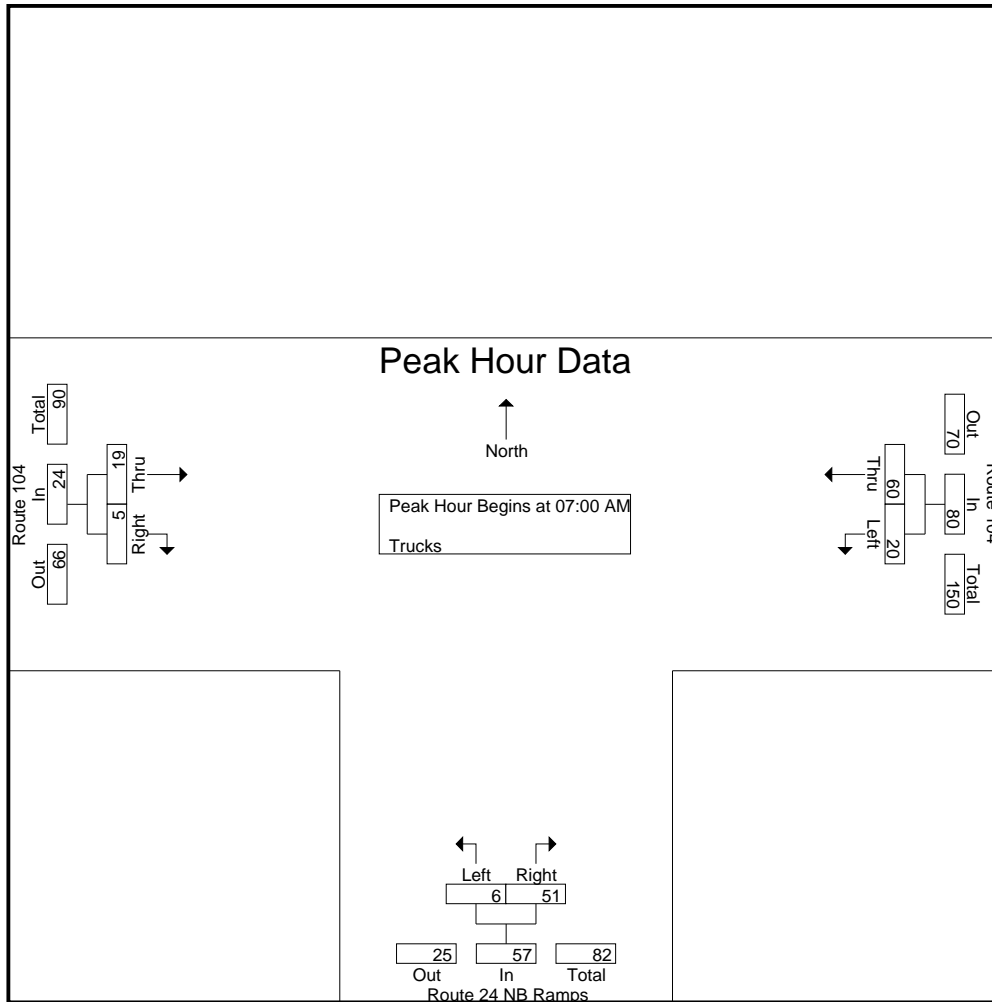

**Peak Hour Analysis From 07:00 AM to 08:45 AM - Peak 1 of 1**

Peak Hour for Each Approach Begins at:

	07:00 AM			07:15 AM			07:00 AM		
+0 mins.	6	11	17	1	<b>19</b>	<b>20</b>	<b>12</b>	1	<b>13</b>
+15 mins.	<b>8</b>	13	21	1	11	12	3	1	4
+30 mins.	3	<b>21</b>	<b>24</b>	2	12	14	0	<b>2</b>	2
+45 mins.	3	15	18	<b>3</b>	9	12	4	1	5
Total Volume	20	60	80	7	51	58	19	5	24
% App. Total	25	75		12.1	87.9		79.2	20.8	
PHF	.625	.714	.833	.583	.671	.725	.396	.625	.462



# Accurate Counts

978-664-2565

N/S Street : Route 24 NB Ramps

E/W Street : Route 104

City/State : Bridgewater, MA

Weather : Clear

File Name : 202700B2

Site Code : 20270002

Start Date : 10/2/2024

Page No : 9

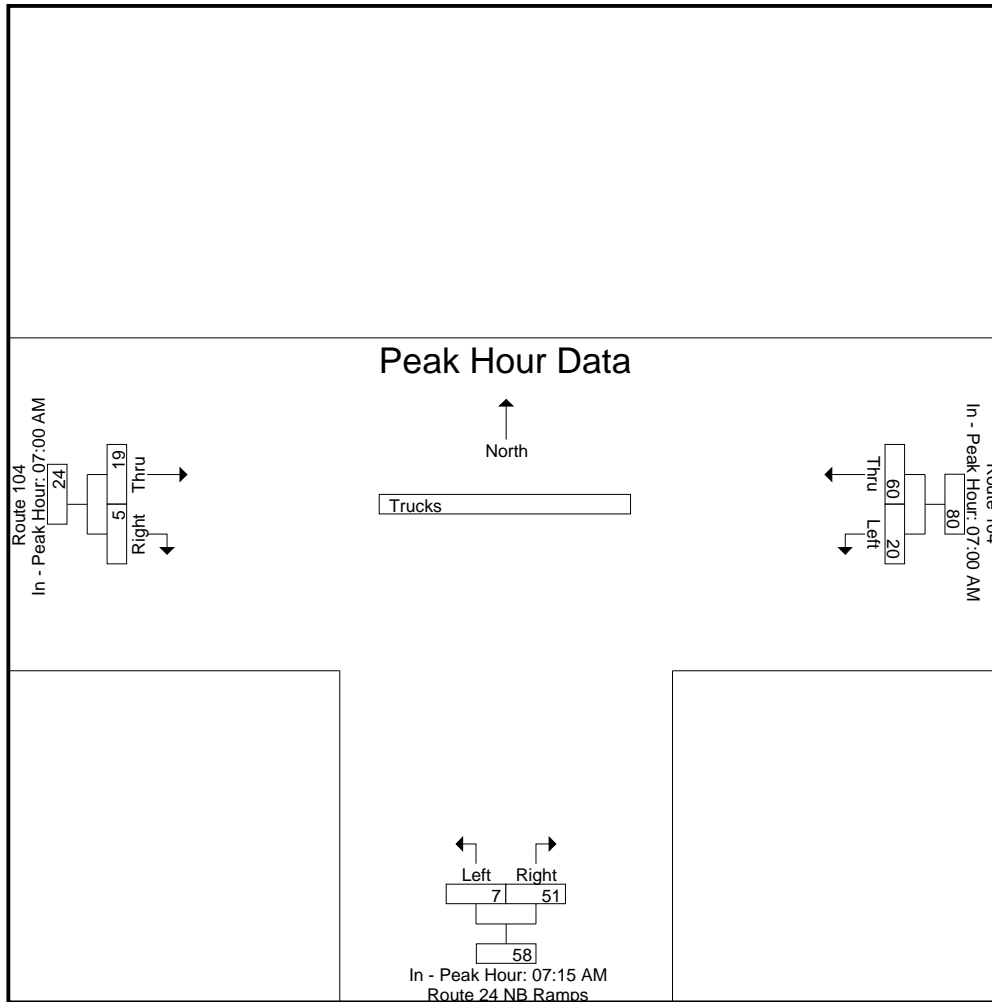



# Accurate Counts

978-664-2565

N/S Street : Route 24 NB Ramps  
 E/W Street : Route 104  
 City/State : Bridgewater, MA  
 Weather : Clear

File Name : 202700B2  
 Site Code : 20270002  
 Start Date : 10/2/2024  
 Page No : 11

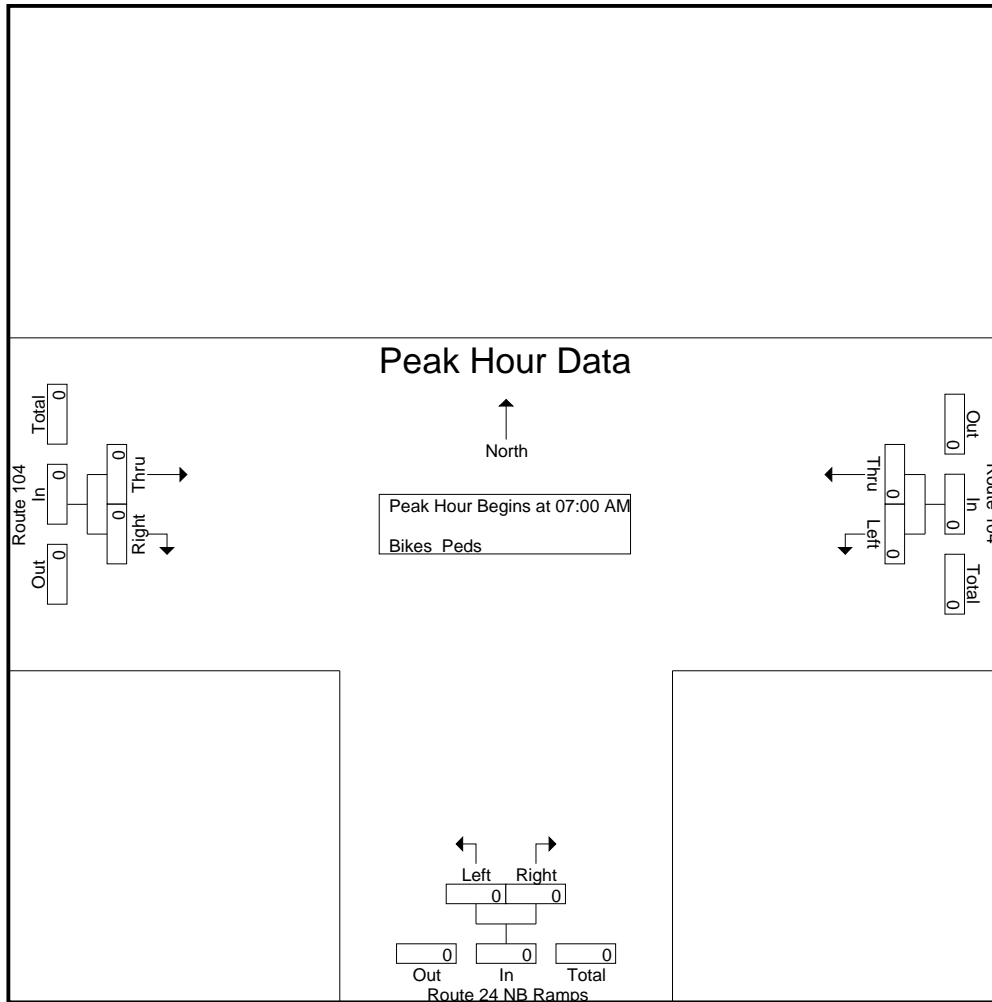

**Peak Hour Analysis From 07:00 AM to 08:45 AM - Peak 1 of 1**

Peak Hour for Each Approach Begins at:

	07:00 AM			07:00 AM			07:00 AM		
+0 mins.	0	0	0	0	0	0	0	0	0
+15 mins.	0	0	0	0	0	0	0	0	0
+30 mins.	0	0	0	0	0	0	0	0	0
+45 mins.	0	0	0	0	0	0	0	0	0
Total Volume	0	0	0	0	0	0	0	0	0
% App. Total	0	0	0	0	0	0	0	0	0
PHF	.000	.000	.000	.000	.000	.000	.000	.000	.000

# Accurate Counts

978-664-2565

N/S Street : Route 24 NB Ramps

E/W Street : Route 104

City/State : Bridgewater, MA

Weather : Clear

File Name : 202700B2

Site Code : 20270002

Start Date : 10/2/2024

Page No : 12

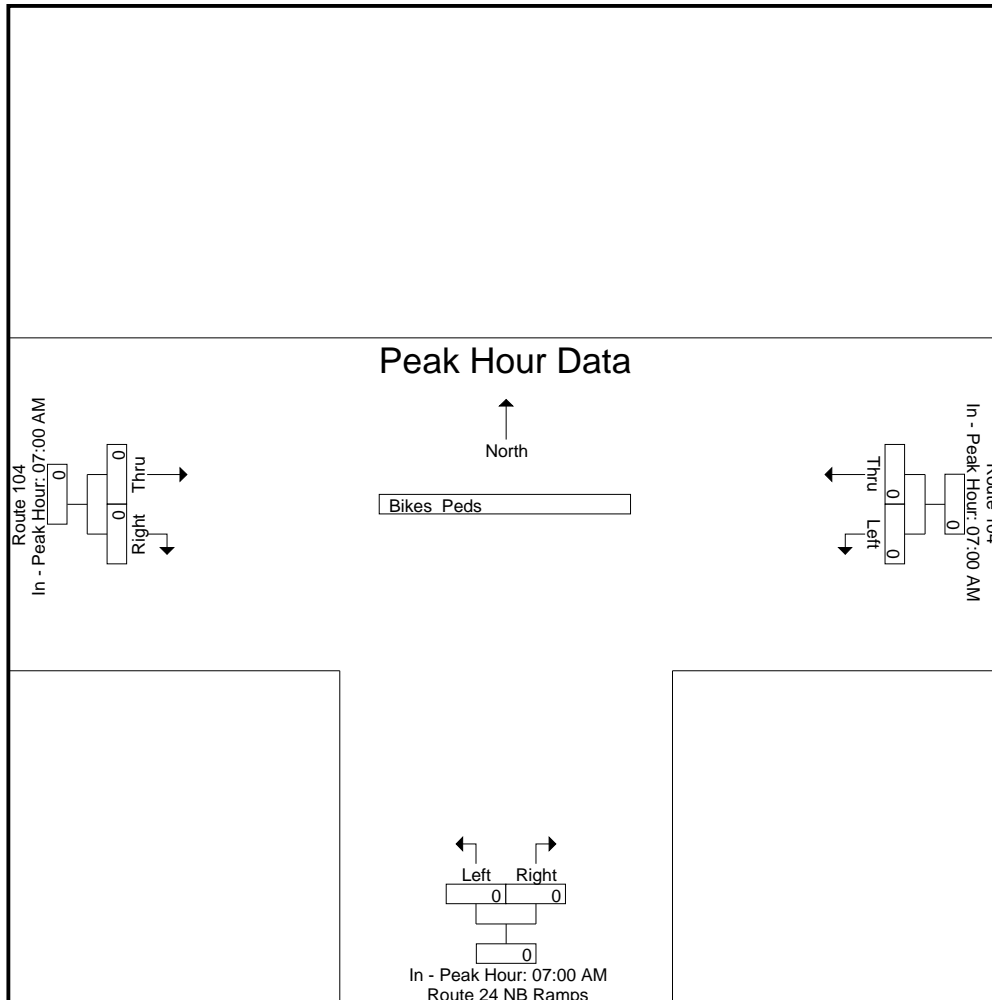

# Accurate Counts

978-664-2565

N/S Street : Route 24 NB Ramps  
 E/W Street : Route 104  
 City/State : Bridgewater, MA  
 Weather : Clear

File Name : 202700B2  
 Site Code : 20270002  
 Start Date : 10/2/2024  
 Page No : 1

### Groups Printed- Cars - Trucks

Start Time	Route 104 From East		Route 24 NB Ramps From South			Route 104 From West		Int. Total
	Left	Thru	Left	Right	Thru	Right		
04:00 PM	41	229	29	186	182	42	709	
04:15 PM	43	237	21	165	213	35	714	
04:30 PM	43	235	28	187	176	44	713	
04:45 PM	50	210	22	199	185	34	700	
<b>Total</b>	<b>177</b>	<b>911</b>	<b>100</b>	<b>737</b>	<b>756</b>	<b>155</b>	<b>2836</b>	
05:00 PM	43	209	20	158	177	35	642	
05:15 PM	53	239	22	167	166	39	686	
05:30 PM	40	211	22	170	178	42	663	
05:45 PM	35	191	21	186	160	35	628	
<b>Total</b>	<b>171</b>	<b>850</b>	<b>85</b>	<b>681</b>	<b>681</b>	<b>151</b>	<b>2619</b>	
<b>Grand Total</b>	<b>348</b>	<b>1761</b>	<b>185</b>	<b>1418</b>	<b>1437</b>	<b>306</b>	<b>5455</b>	
Apprch %	16.5	83.5	11.5	88.5	82.4	17.6		
Total %	6.4	32.3	3.4	26	26.3	5.6		
Cars	339	1726	179	1375	1401	303	5323	
% Cars	97.4	98	96.8	97	97.5	99	97.6	
Trucks	9	35	6	43	36	3	132	
% Trucks	2.6	2	3.2	3	2.5	1	2.4	

Start Time	Route 104 From East			Route 24 NB Ramps From South			Route 104 From West			Int. Total
	Left	Thru	App. Total	Left	Right	App. Total	Thru	Right	App. Total	
Peak Hour Analysis From 04:00 PM to 05:45 PM - Peak 1 of 1										
Peak Hour for Entire Intersection Begins at 04:00 PM										
04:00 PM	41	229	270	<b>29</b>	186	215	182	42	224	709
04:15 PM	43	<b>237</b>	<b>280</b>	21	165	186	<b>213</b>	35	<b>248</b>	<b>714</b>
04:30 PM	43	235	278	28	187	215	176	<b>44</b>	220	713
04:45 PM	<b>50</b>	210	260	22	<b>199</b>	<b>221</b>	185	34	219	700
<b>Total Volume</b>	177	911	1088	100	737	837	756	155	911	2836
% App. Total	16.3	83.7		11.9	88.1		83	17		
PHF	.885	.961	.971	.862	.926	.947	.887	.881	.918	.993
Cars	174	887	1061	96	709	805	735	153	888	2754
% Cars	98.3	97.4	97.5	96.0	96.2	96.2	97.2	98.7	97.5	97.1
Trucks	3	24	27	4	28	32	21	2	23	82
% Trucks	1.7	2.6	2.5	4.0	3.8	3.8	2.8	1.3	2.5	2.9

# Accurate Counts

978-664-2565

N/S Street : Route 24 NB Ramps  
 E/W Street : Route 104  
 City/State : Bridgewater, MA  
 Weather : Clear

File Name : 202700B2  
 Site Code : 20270002  
 Start Date : 10/2/2024  
 Page No : 2

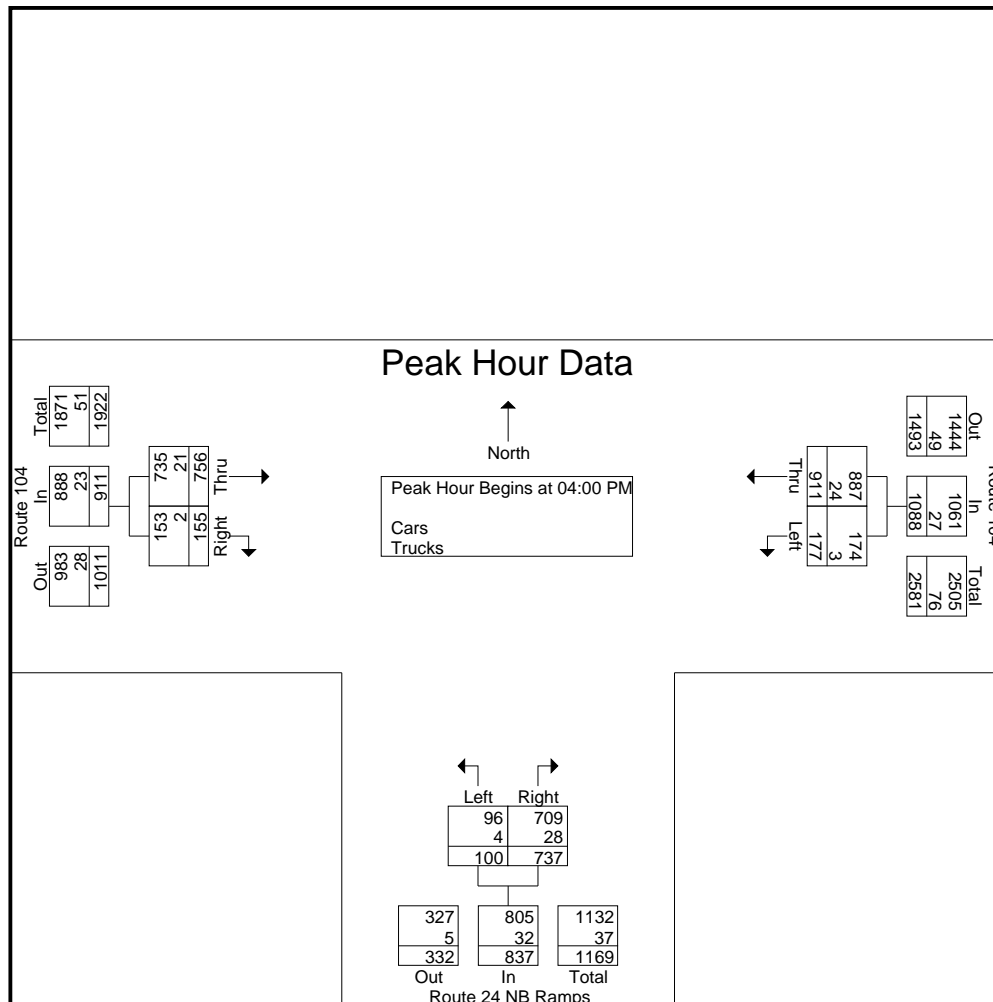

## Peak Hour Analysis From 04:00 PM to 05:45 PM - Peak 1 of 1

### Peak Hour for Each Approach Begins at:

	04:00 PM			04:00 PM			04:00 PM		
+0 mins.	41	229	270	<b>29</b>	186	215	182	42	224
+15 mins.	43	<b>237</b>	<b>280</b>	21	165	186	<b>213</b>	35	<b>248</b>
+30 mins.	43	235	278	28	187	215	176	<b>44</b>	220
+45 mins.	<b>50</b>	210	260	22	<b>199</b>	<b>221</b>	185	34	219
Total Volume	177	911	1088	100	737	837	756	155	911
% App. Total	16.3	83.7		11.9	88.1		83	17	
PHF	.885	.961	.971	.862	.926	.947	.887	.881	.918
Cars	174	887	1061	96	709	805	735	153	888
% Cars	98.3	97.4	97.5	96	96.2	96.2	97.2	98.7	97.5
Trucks	3	24	27	4	28	32	21	2	23
% Trucks	1.7	2.6	2.5	4	3.8	3.8	2.8	1.3	2.5

# Accurate Counts

978-664-2565

File Name : 202700B2

Site Code : 20270002

Start Date : 10/2/2024

Page No : 3

N/S Street : Route 24 NB Ramps

E/W Street : Route 104

City/State : Bridgewater, MA

Weather : Clear

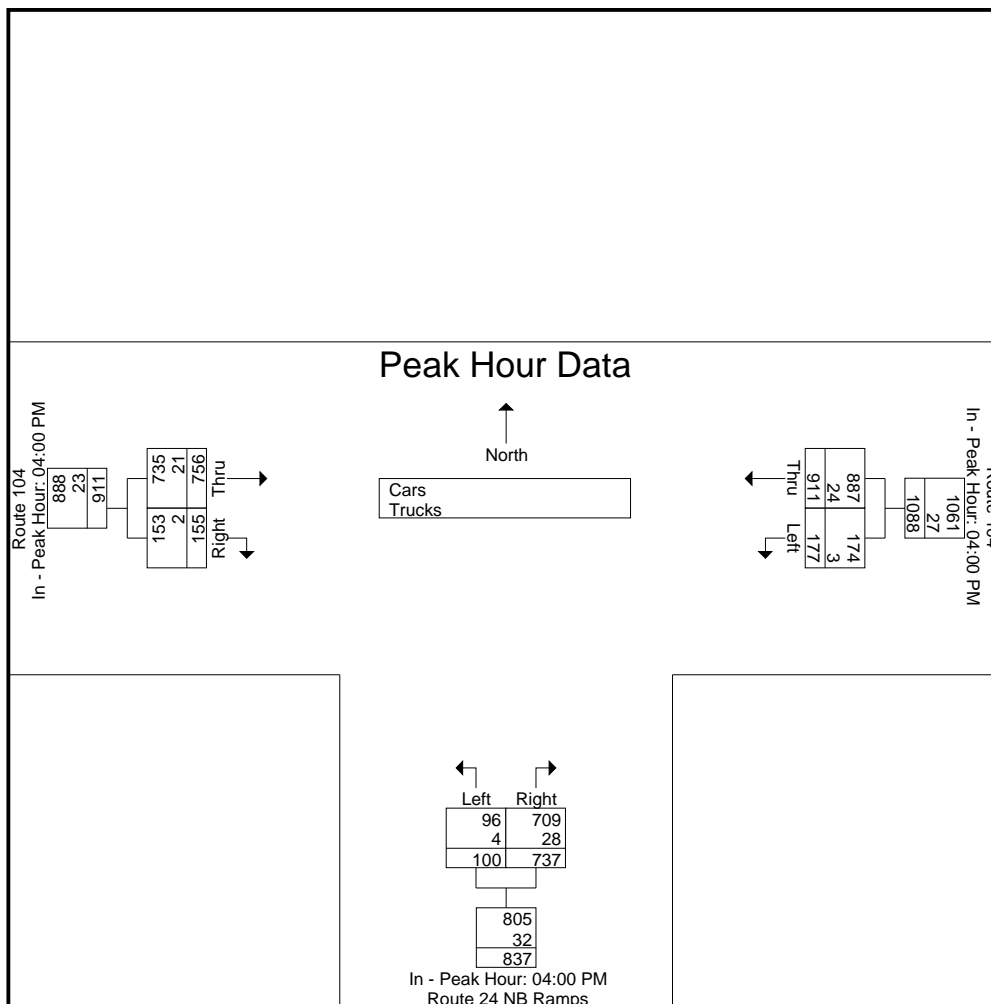

# Accurate Counts

978-664-2565

N/S Street : Route 24 NB Ramps  
 E/W Street : Route 104  
 City/State : Bridgewater, MA  
 Weather : Clear

File Name : 202700B2  
 Site Code : 20270002  
 Start Date : 10/2/2024  
 Page No : 4

## Groups Printed- Cars

Start Time	Route 104 From East		Route 24 NB Ramps From South		Route 104 From West		Int. Total
	Left	Thru	Left	Right	Thru	Right	
04:00 PM	40	223	28	180	175	41	687
04:15 PM	41	234	21	158	206	35	695
04:30 PM	43	226	27	177	174	44	691
04:45 PM	50	204	20	194	180	33	681
<b>Total</b>	<b>174</b>	<b>887</b>	<b>96</b>	<b>709</b>	<b>735</b>	<b>153</b>	<b>2754</b>
05:00 PM	41	206	19	155	171	35	627
05:15 PM	49	235	22	165	166	38	675
05:30 PM	40	209	22	163	172	42	648
05:45 PM	35	189	20	183	157	35	619
<b>Total</b>	<b>165</b>	<b>839</b>	<b>83</b>	<b>666</b>	<b>666</b>	<b>150</b>	<b>2569</b>
<b>Grand Total</b>	<b>339</b>	<b>1726</b>	<b>179</b>	<b>1375</b>	<b>1401</b>	<b>303</b>	<b>5323</b>
Apprch %	16.4	83.6	11.5	88.5	82.2	17.8	
Total %	6.4	32.4	3.4	25.8	26.3	5.7	

Start Time	Route 104 From East			Route 24 NB Ramps From South			Route 104 From West			Int. Total
	Left	Thru	App. Total	Left	Right	App. Total	Thru	Right	App. Total	
Peak Hour Analysis From 04:00 PM to 05:45 PM - Peak 1 of 1										
Peak Hour for Entire Intersection Begins at 04:00 PM										
04:00 PM	40	223	263	<b>28</b>	180	208	175	41	216	687
04:15 PM	41	<b>234</b>	<b>275</b>	21	158	179	<b>206</b>	35	<b>241</b>	<b>695</b>
04:30 PM	43	226	269	27	177	204	174	<b>44</b>	218	691
04:45 PM	<b>50</b>	204	254	20	<b>194</b>	<b>214</b>	180	33	213	681
<b>Total Volume</b>	174	887	1061	96	709	805	735	153	888	2754
% App. Total	16.4	83.6		11.9	88.1		82.8	17.2		
PHF	.870	.948	.965	.857	.914	.940	.892	.869	.921	.991



# Accurate Counts

978-664-2565

N/S Street : Route 24 NB Ramps  
 E/W Street : Route 104  
 City/State : Bridgewater, MA  
 Weather : Clear

File Name : 202700B2  
 Site Code : 20270002  
 Start Date : 10/2/2024  
 Page No : 5

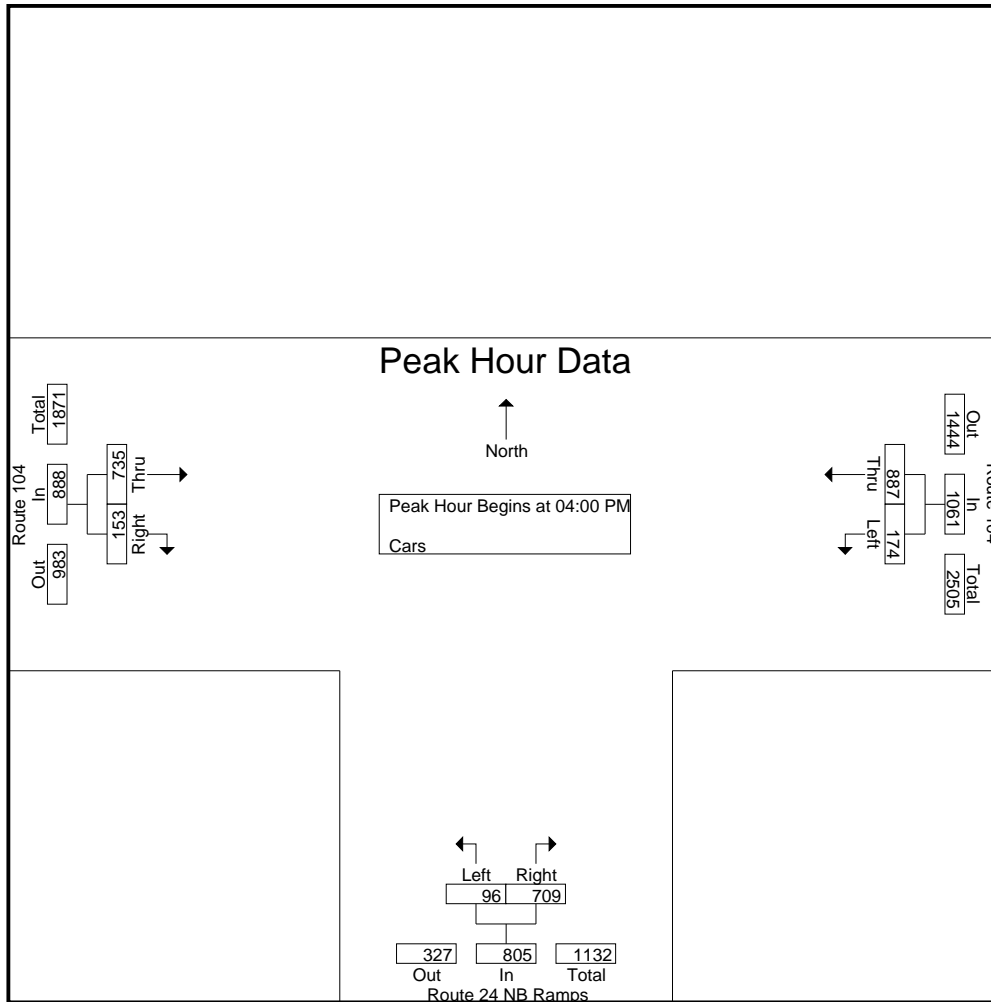

**Peak Hour Analysis From 04:00 PM to 05:45 PM - Peak 1 of 1**

Peak Hour for Each Approach Begins at:

	04:00 PM			04:00 PM			04:00 PM		
+0 mins.	40	223	263	<b>28</b>	180	208	175	41	216
+15 mins.	41	<b>234</b>	<b>275</b>	21	158	179	<b>206</b>	35	<b>241</b>
+30 mins.	43	226	269	27	177	204	174	<b>44</b>	218
+45 mins.	<b>50</b>	204	254	20	<b>194</b>	<b>214</b>	180	33	213
Total Volume	174	887	1061	96	709	805	735	153	888
% App. Total	16.4	83.6		11.9	88.1		82.8	17.2	
PHF	.870	.948	.965	.857	.914	.940	.892	.869	.921

# Accurate Counts

978-664-2565

File Name : 202700B2

Site Code : 20270002

Start Date : 10/2/2024

Page No : 6

N/S Street : Route 24 NB Ramps

E/W Street : Route 104

City/State : Bridgewater, MA

Weather : Clear

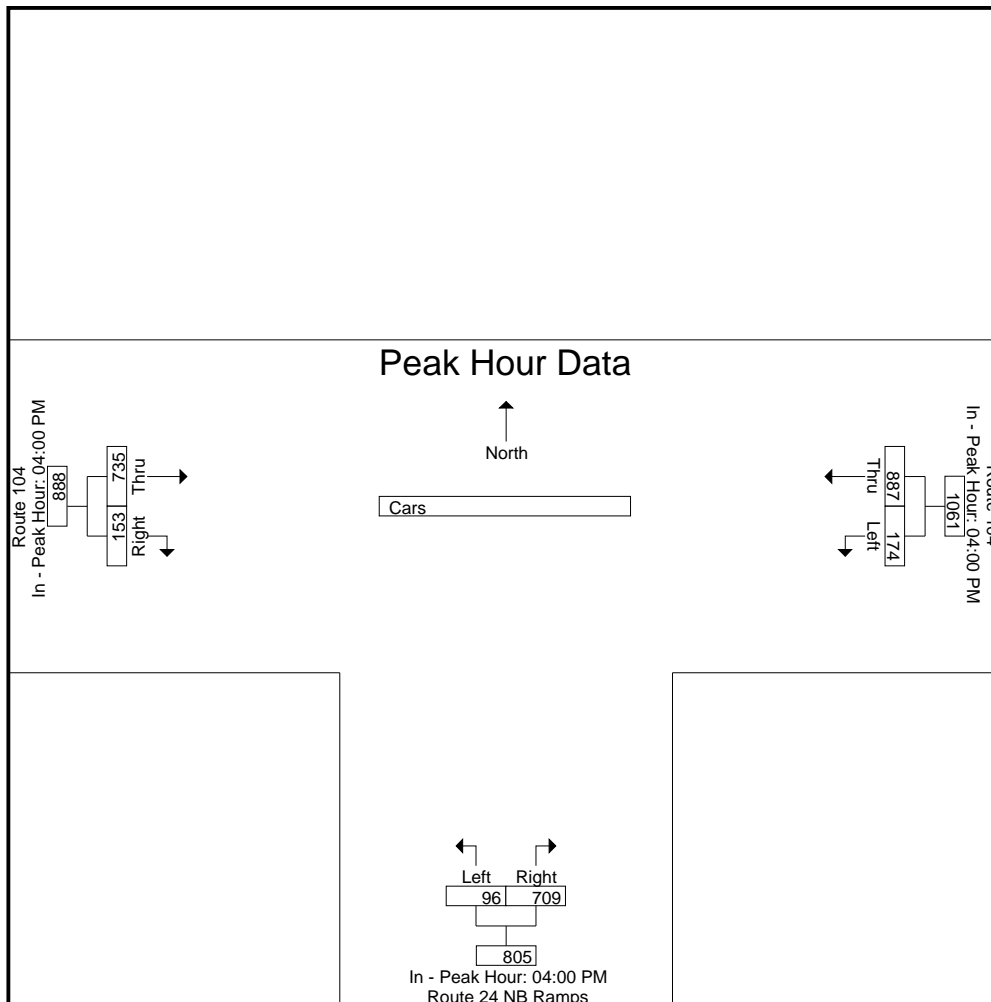

# Accurate Counts

978-664-2565

N/S Street : Route 24 NB Ramps  
 E/W Street : Route 104  
 City/State : Bridgewater, MA  
 Weather : Clear

File Name : 202700B2  
 Site Code : 20270002  
 Start Date : 10/2/2024  
 Page No : 7

### Groups Printed- Trucks

Start Time	Route 104 From East		Route 24 NB Ramps From South		Route 104 From West		Int. Total
	Left	Thru	Left	Right	Thru	Right	
04:00 PM	1	6	1	6	7	1	22
04:15 PM	2	3	0	7	7	0	19
04:30 PM	0	9	1	10	2	0	22
04:45 PM	0	6	2	5	5	1	19
<b>Total</b>	<b>3</b>	<b>24</b>	<b>4</b>	<b>28</b>	<b>21</b>	<b>2</b>	<b>82</b>
05:00 PM	2	3	1	3	6	0	15
05:15 PM	4	4	0	2	0	1	11
05:30 PM	0	2	0	7	6	0	15
05:45 PM	0	2	1	3	3	0	9
<b>Total</b>	<b>6</b>	<b>11</b>	<b>2</b>	<b>15</b>	<b>15</b>	<b>1</b>	<b>50</b>
<b>Grand Total</b>	<b>9</b>	<b>35</b>	<b>6</b>	<b>43</b>	<b>36</b>	<b>3</b>	<b>132</b>
Apprch %	20.5	79.5	12.2	87.8	92.3	7.7	
Total %	6.8	26.5	4.5	32.6	27.3	2.3	

Start Time	Route 104 From East			Route 24 NB Ramps From South			Route 104 From West			Int. Total
	Left	Thru	App. Total	Left	Right	App. Total	Thru	Right	App. Total	
Peak Hour Analysis From 04:00 PM to 05:45 PM - Peak 1 of 1										
Peak Hour for Entire Intersection Begins at 04:00 PM										
04:00 PM	1	6	7	1	6	7	7	1	8	22
04:15 PM	2	3	5	0	7	7	7	0	7	19
04:30 PM	0	9	9	1	10	11	2	0	2	22
04:45 PM	0	6	6	2	5	7	5	1	6	19
<b>Total Volume</b>	<b>3</b>	<b>24</b>	<b>27</b>	<b>4</b>	<b>28</b>	<b>32</b>	<b>21</b>	<b>2</b>	<b>23</b>	<b>82</b>
% App. Total	11.1	88.9		12.5	87.5		91.3	8.7		
PHF	.375	.667	.750	.500	.700	.727	.750	.500	.719	.932

# Accurate Counts

978-664-2565

N/S Street : Route 24 NB Ramps  
 E/W Street : Route 104  
 City/State : Bridgewater, MA  
 Weather : Clear

File Name : 202700B2  
 Site Code : 20270002  
 Start Date : 10/2/2024  
 Page No : 8

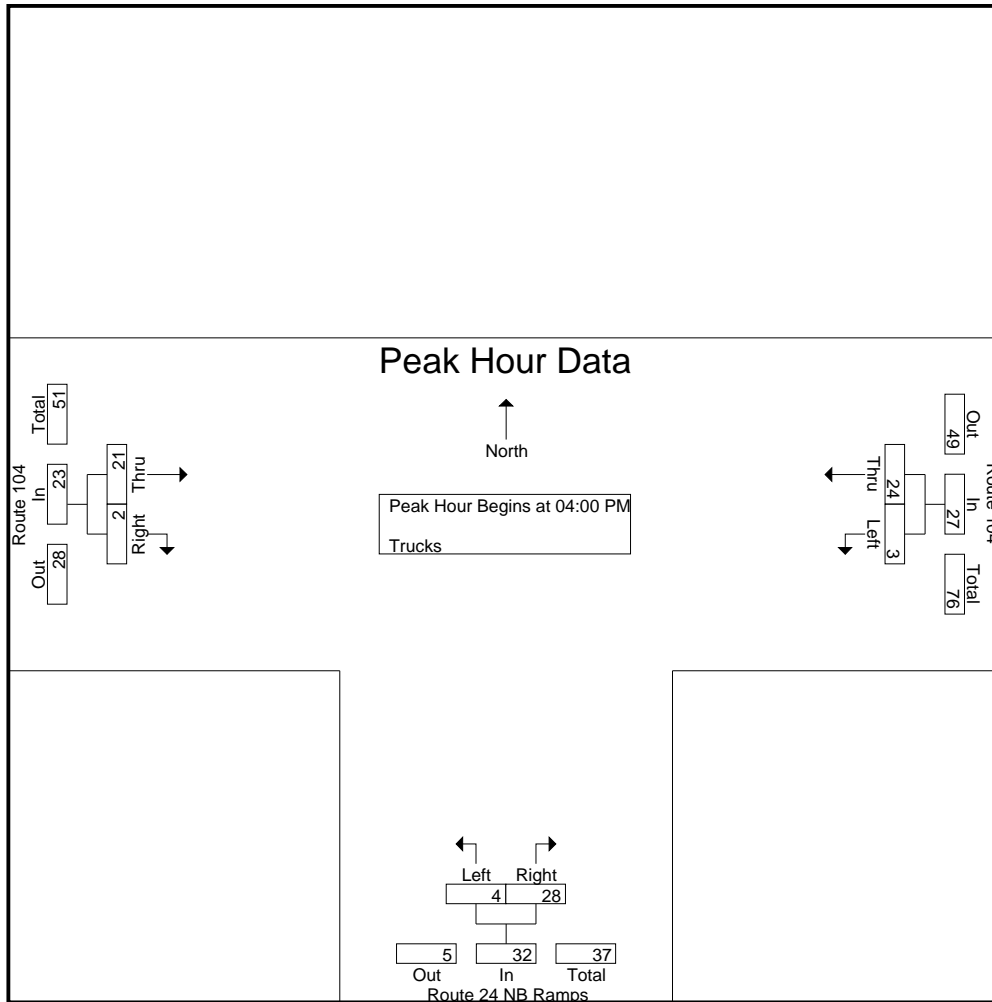

Peak Hour Analysis From 04:00 PM to 05:45 PM - Peak 1 of 1

Peak Hour for Each Approach Begins at:

	04:30 PM			04:00 PM			04:00 PM		
+0 mins.	0	9	9	1	6	7	7	1	8
+15 mins.	0	6	6	0	7	7	7	0	7
+30 mins.	2	3	5	1	10	11	2	0	2
+45 mins.	4	4	8	2	5	7	5	1	6
Total Volume	6	22	28	4	28	32	21	2	23
% App. Total	21.4	78.6		12.5	87.5		91.3	8.7	
PHF	.375	.611	.778	.500	.700	.727	.750	.500	.719

# Accurate Counts

978-664-2565

File Name : 202700B2

Site Code : 20270002

Start Date : 10/2/2024

Page No : 9

N/S Street : Route 24 NB Ramps

E/W Street : Route 104

City/State : Bridgewater, MA

Weather : Clear

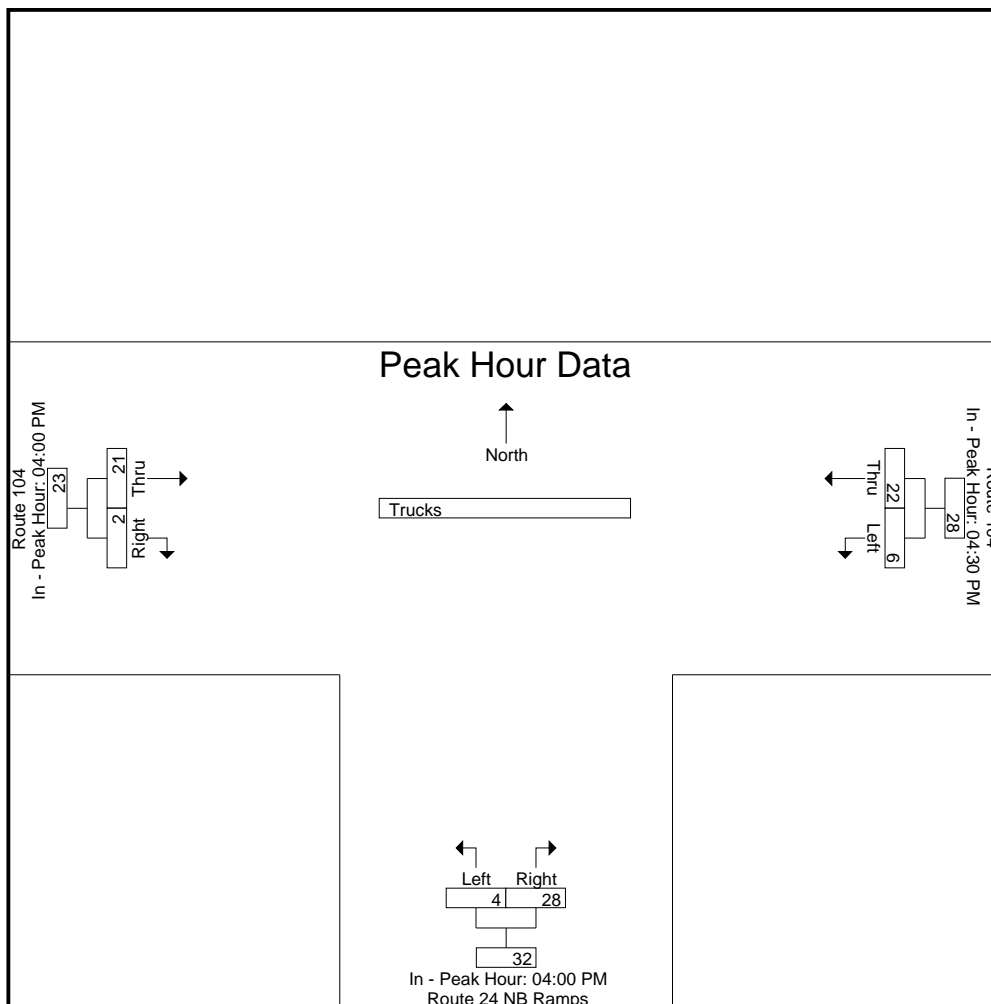

# Accurate Counts

978-664-2565

N/S Street : Route 24 NB Ramps  
 E/W Street : Route 104  
 City/State : Bridgewater, MA  
 Weather : Clear

File Name : 202700B2  
 Site Code : 20270002  
 Start Date : 10/2/2024  
 Page No : 10

### Groups Printed- Bikes Peds

Start Time	Route 104 From East			Route 24 NB Ramps From South			Route 104 From West			Exclu. Total	Inclu. Total	Int. Total
	Left	Thru	Peds	Left	Right	Peds	Thru	Right	Peds			
04:00 PM	0	0	0	0	0	0	0	0	0	0	0	0
04:15 PM	0	0	0	0	0	0	1	0	0	0	1	1
04:30 PM	0	0	0	0	0	0	1	0	0	0	1	1
04:45 PM	0	0	0	0	0	0	0	0	0	0	0	0
<b>Total</b>	0	0	0	0	0	0	2	0	0	0	2	2
05:00 PM	0	0	0	0	0	0	0	0	0	0	0	0
05:15 PM	0	0	0	0	0	0	0	0	0	0	0	0
05:30 PM	0	0	0	0	0	0	0	0	0	0	0	0
05:45 PM	0	0	0	0	0	0	0	0	0	0	0	0
<b>Total</b>	0	0	0	0	0	0	0	0	0	0	0	0
<b>Grand Total</b>	0	0	0	0	0	0	2	0	0	0	2	2
Apprch %	0	0		0	0		100	0				
Total %	0	0		0	0		100	0			100	

Start Time	Route 104 From East			Route 24 NB Ramps From South			Route 104 From West			Int. Total
	Left	Thru	App. Total	Left	Right	App. Total	Thru	Right	App. Total	
Peak Hour Analysis From 04:00 PM to 05:45 PM - Peak 1 of 1										
Peak Hour for Entire Intersection Begins at 04:00 PM										
04:00 PM	0	0	0	0	0	0	0	0	0	0
04:15 PM	0	0	0	0	0	0	1	0	1	1
04:30 PM	0	0	0	0	0	0	1	0	1	1
04:45 PM	0	0	0	0	0	0	0	0	0	0
<b>Total Volume</b>	0	0	0	0	0	0	2	0	2	2
<b>% App. Total</b>	0	0		0	0		100	0		
<b>PHF</b>	.000	.000	.000	.000	.000	.000	.500	.000	.500	.500

# Accurate Counts

978-664-2565

N/S Street : Route 24 NB Ramps  
 E/W Street : Route 104  
 City/State : Bridgewater, MA  
 Weather : Clear

File Name : 202700B2  
 Site Code : 20270002  
 Start Date : 10/2/2024  
 Page No : 11

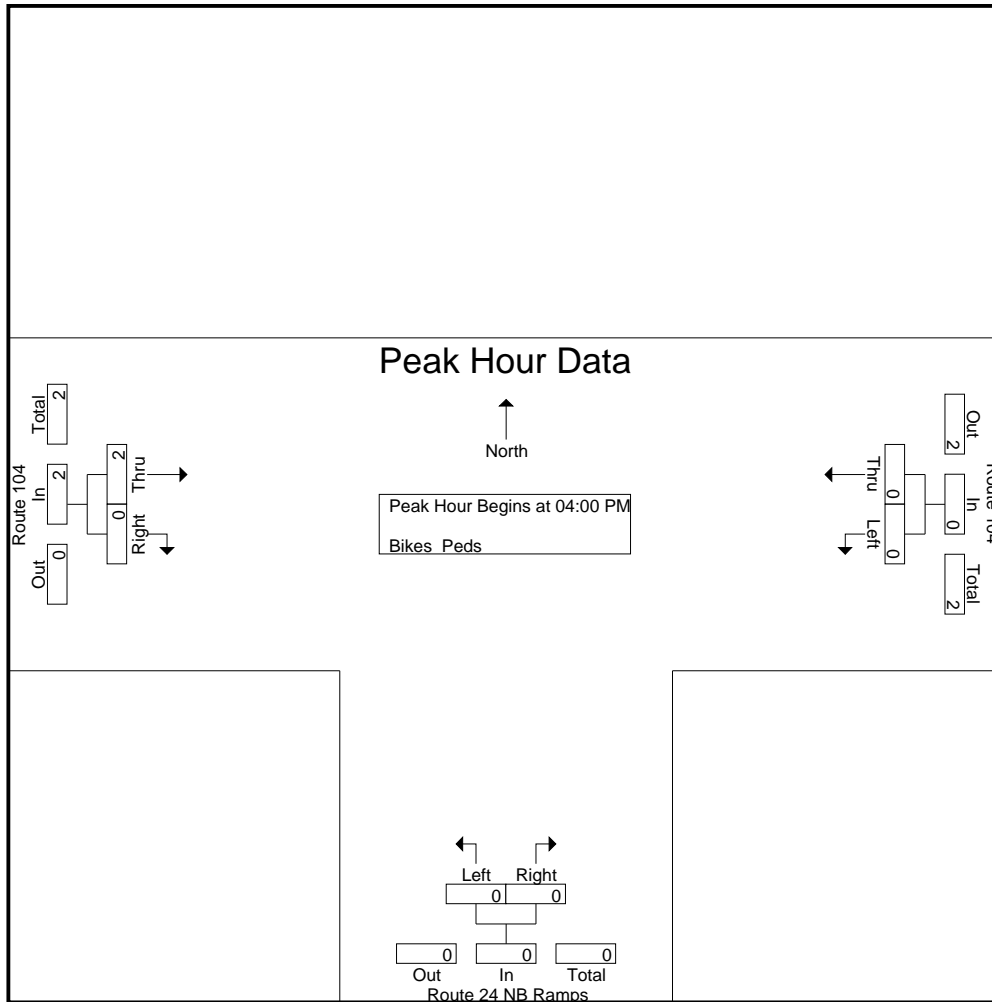

Peak Hour Analysis From 04:00 PM to 05:45 PM - Peak 1 of 1

Peak Hour for Each Approach Begins at:

	04:00 PM			04:00 PM			04:00 PM		
+0 mins.	0	0	0	0	0	0	0	0	0
+15 mins.	0	0	0	0	0	0	1	0	1
+30 mins.	0	0	0	0	0	0	1	0	1
+45 mins.	0	0	0	0	0	0	0	0	0
Total Volume	0	0	0	0	0	0	2	0	2
% App. Total	0	0	0	0	0	0	100	0	0
PHF	.000	.000	.000	.000	.000	.000	.500	.000	.500

# Accurate Counts

978-664-2565

File Name : 202700B2

Site Code : 20270002

Start Date : 10/2/2024

Page No : 12

N/S Street : Route 24 NB Ramps

E/W Street : Route 104

City/State : Bridgewater, MA

Weather : Clear

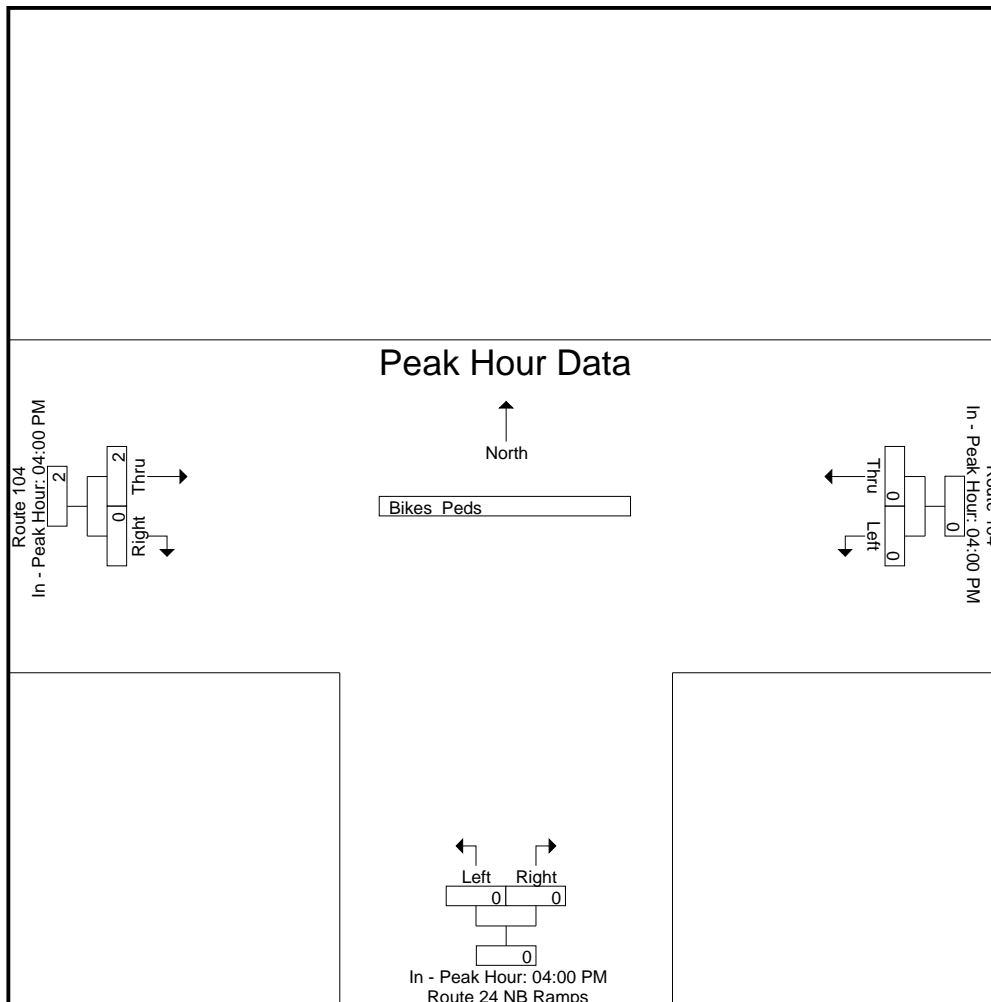



# Accurate Counts

978-664-2565

N/S Street : Elm St / Old Pleasant St  
 E/W Street : Pleasant Street  
 City/State : Bridgewater, MA  
 Weather : Clear

File Name : 202700B3  
 Site Code : 20270003  
 Start Date : 10/2/2024  
 Page No : 1

### Groups Printed- Cars - Trucks

Start Time	Elm St From North			Pleasant St From East			Old Pleasant St From South			Pleasant St From West			Int. Total
	Left	Thru	Right	Left	Thru	Right	Left	Thru	Right	Left	Thru	Right	
07:00 AM	17	0	51	1	227	18	25	14	12	66	218	10	659
07:15 AM	18	3	59	3	269	18	28	7	3	44	205	4	661
07:30 AM	13	8	52	3	296	16	18	7	3	62	223	12	713
07:45 AM	10	3	35	3	237	18	18	12	8	69	231	17	661
<b>Total</b>	<b>58</b>	<b>14</b>	<b>197</b>	<b>10</b>	<b>1029</b>	<b>70</b>	<b>89</b>	<b>40</b>	<b>26</b>	<b>241</b>	<b>877</b>	<b>43</b>	<b>2694</b>
08:00 AM	10	4	43	3	257	14	13	14	9	54	207	11	639
08:15 AM	16	8	40	4	217	18	18	6	6	51	217	23	624
08:30 AM	14	4	36	5	205	17	12	3	4	35	214	16	565
08:45 AM	20	4	33	3	174	21	11	7	6	40	182	10	511
<b>Total</b>	<b>60</b>	<b>20</b>	<b>152</b>	<b>15</b>	<b>853</b>	<b>70</b>	<b>54</b>	<b>30</b>	<b>25</b>	<b>180</b>	<b>820</b>	<b>60</b>	<b>2339</b>
<b>Grand Total</b>	<b>118</b>	<b>34</b>	<b>349</b>	<b>25</b>	<b>1882</b>	<b>140</b>	<b>143</b>	<b>70</b>	<b>51</b>	<b>421</b>	<b>1697</b>	<b>103</b>	<b>5033</b>
Apprch %	23.6	6.8	69.7	1.2	91.9	6.8	54.2	26.5	19.3	19	76.4	4.6	
Total %	2.3	0.7	6.9	0.5	37.4	2.8	2.8	1.4	1	8.4	33.7	2	
Cars	94	29	291	22	1804	130	142	70	49	389	1596	99	4715
% Cars	79.7	85.3	83.4	88	95.9	92.9	99.3	100	96.1	92.4	94	96.1	93.7
Trucks	24	5	58	3	78	10	1	0	2	32	101	4	318
% Trucks	20.3	14.7	16.6	12	4.1	7.1	0.7	0	3.9	7.6	6	3.9	6.3

Start Time	Elm St From North				Pleasant St From East				Old Pleasant St From South				Pleasant St From West				Int. Total
	Left	Thru	Right	App. Total	Left	Thru	Right	App. Total	Left	Thru	Right	App. Total	Left	Thru	Right	App. Total	
Peak Hour Analysis From 07:00 AM to 08:45 AM - Peak 1 of 1																	
Peak Hour for Entire Intersection Begins at 07:00 AM																	
07:00 AM	17	0	51	68	1	227	<b>18</b>	246	25	<b>14</b>	<b>12</b>	<b>51</b>	66	218	10	294	659
07:15 AM	<b>18</b>	3	<b>59</b>	<b>80</b>	<b>3</b>	269	18	290	<b>28</b>	7	3	38	44	205	4	253	661
07:30 AM	13	<b>8</b>	52	73	3	<b>296</b>	16	<b>315</b>	18	7	3	28	62	223	12	297	<b>713</b>
07:45 AM	10	3	35	48	3	237	18	258	18	12	8	38	<b>69</b>	<b>231</b>	<b>17</b>	<b>317</b>	661
Total Volume	58	14	197	269	10	1029	70	1109	89	40	26	155	241	877	43	1161	2694
% App. Total	21.6	5.2	73.2		0.9	92.8	6.3		57.4	25.8	16.8		20.8	75.5	3.7		
PHF	.806	.438	.835	.841	.833	.869	.972	.880	.795	.714	.542	.760	.873	.949	.632	.916	.945
Cars	46	9	165	220	9	987	66	1062	88	40	25	153	224	825	41	1090	2525
% Cars	79.3	64.3	83.8	81.8	90.0	95.9	94.3	95.8	98.9	100	96.2	98.7	92.9	94.1	95.3	93.9	93.7
Trucks	12	5	32	49	1	42	4	47	1	0	1	2	17	52	2	71	169
% Trucks	20.7	35.7	16.2	18.2	10.0	4.1	5.7	4.2	1.1	0	3.8	1.3	7.1	5.9	4.7	6.1	6.3

# Accurate Counts

978-664-2565

N/S Street : Elm St / Old Pleasant St  
 E/W Street : Pleasant Street  
 City/State : Bridgewater, MA  
 Weather : Clear

File Name : 202700B3  
 Site Code : 20270003  
 Start Date : 10/2/2024  
 Page No : 2

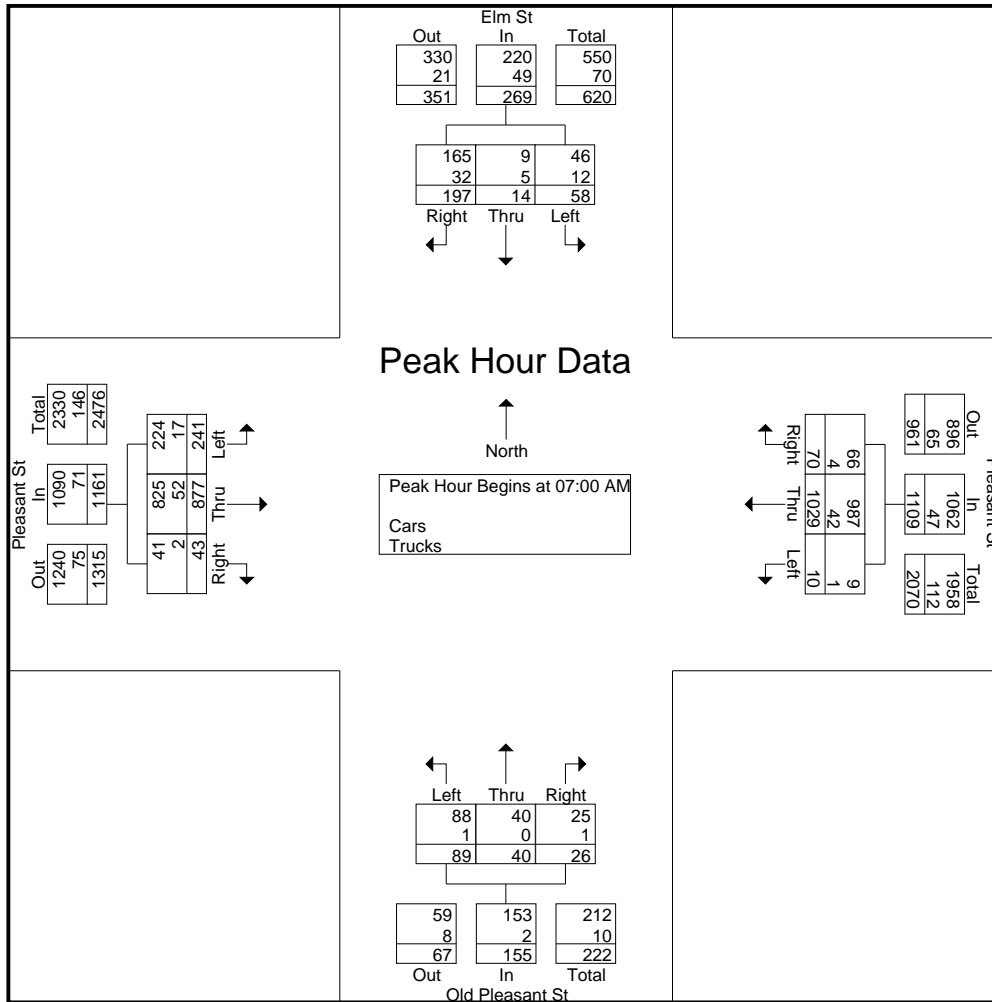

**Peak Hour Analysis From 07:00 AM to 08:45 AM - Peak 1 of 1**

**Peak Hour for Each Approach Begins at:**

	07:00 AM				07:15 AM				07:30 AM				07:45 AM			
+0 mins.	17	0	51	68	3	269	18	290	25	14	12	51	62	223	12	297
+15 mins.	18	3	59	80	3	296	16	315	28	7	3	38	69	231	17	317
+30 mins.	13	8	52	73	3	237	18	258	18	7	3	28	54	207	11	272
+45 mins.	10	3	35	48	3	257	14	274	18	12	8	38	51	217	23	291
Total Volume	58	14	197	269	12	1059	66	1137	89	40	26	155	236	878	63	1177
% App. Total	21.6	5.2	73.2		1.1	93.1	5.8		57.4	25.8	16.8		20.1	74.6	5.4	
PHF	.806	.438	.835	.841	1.000	.894	.917	.902	.795	.714	.542	.760	.855	.950	.685	.928
Cars	46	9	165	220	11	1021	61	1093	88	40	25	153	219	837	61	1117
% Cars	79.3	64.3	83.8	81.8	91.7	96.4	92.4	96.1	98.9	100	96.2	98.7	92.8	95.3	96.8	94.9
Trucks	12	5	32	49	1	38	5	44	1	0	1	2	17	41	2	60
% Trucks	20.7	35.7	16.2	18.2	8.3	3.6	7.6	3.9	1.1	0	3.8	1.3	7.2	4.7	3.2	5.1

# Accurate Counts

978-664-2565

File Name : 202700B3

Site Code : 20270003

Start Date : 10/2/2024

Page No : 3

N/S Street : Elm St / Old Pleasant St

E/W Street : Pleasant Street

City/State : Bridgewater, MA

Weather : Clear

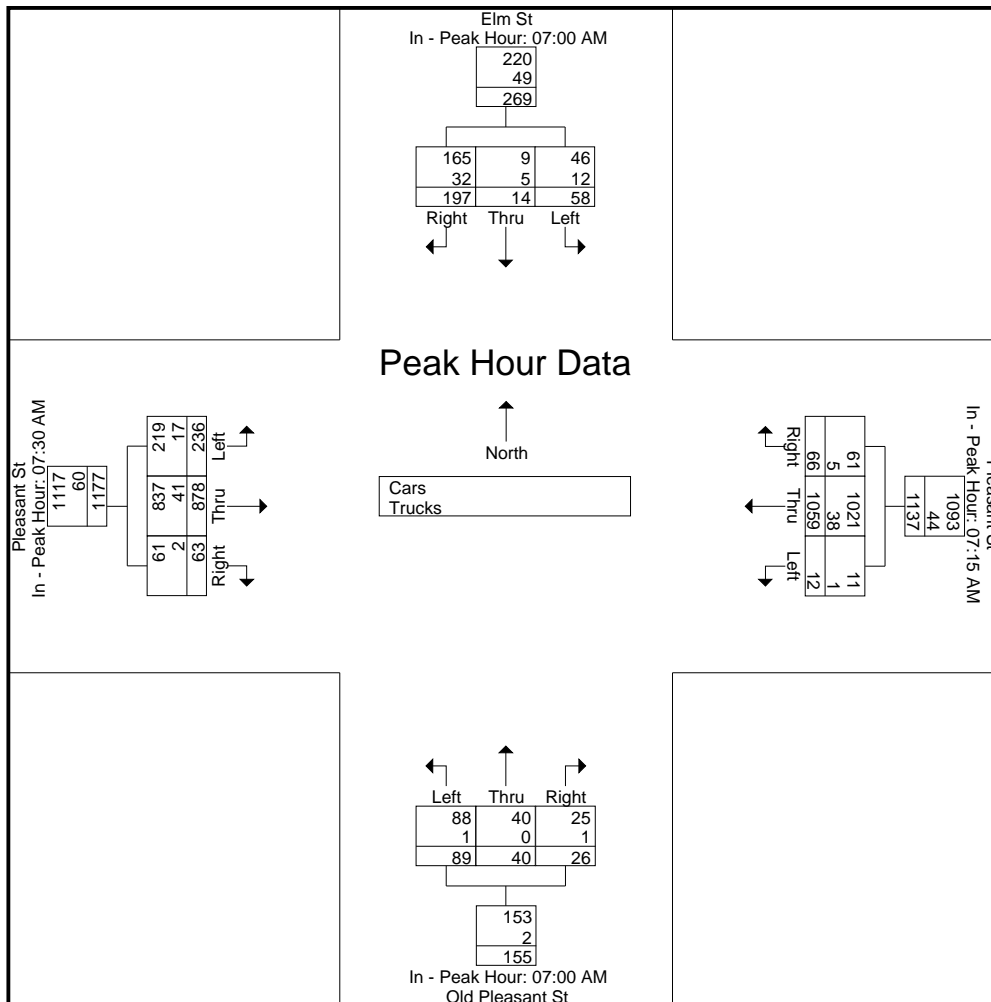

# Accurate Counts

978-664-2565

N/S Street : Elm St / Old Pleasant St  
 E/W Street : Pleasant Street  
 City/State : Bridgewater, MA  
 Weather : Clear

File Name : 202700B3  
 Site Code : 20270003  
 Start Date : 10/2/2024  
 Page No : 4

### Groups Printed- Cars

Start Time	Elm St From North			Pleasant St From East			Old Pleasant St From South			Pleasant St From West			Int. Total
	Left	Thru	Right	Left	Thru	Right	Left	Thru	Right	Left	Thru	Right	
07:00 AM	15	0	42	1	216	18	25	14	11	62	202	9	615
07:15 AM	15	2	53	3	258	16	27	7	3	40	189	4	617
07:30 AM	7	4	36	3	285	16	18	7	3	58	212	11	660
07:45 AM	9	3	34	2	228	16	18	12	8	64	222	17	633
<b>Total</b>	<b>46</b>	<b>9</b>	<b>165</b>	<b>9</b>	<b>987</b>	<b>66</b>	<b>88</b>	<b>40</b>	<b>25</b>	<b>224</b>	<b>825</b>	<b>41</b>	<b>2525</b>
08:00 AM	8	4	37	3	250	13	13	14	9	52	197	11	611
08:15 AM	15	8	33	3	206	16	18	6	6	45	206	22	584
08:30 AM	10	4	26	4	194	16	12	3	4	32	196	15	516
08:45 AM	15	4	30	3	167	19	11	7	5	36	172	10	479
<b>Total</b>	<b>48</b>	<b>20</b>	<b>126</b>	<b>13</b>	<b>817</b>	<b>64</b>	<b>54</b>	<b>30</b>	<b>24</b>	<b>165</b>	<b>771</b>	<b>58</b>	<b>2190</b>
<b>Grand Total</b>	<b>94</b>	<b>29</b>	<b>291</b>	<b>22</b>	<b>1804</b>	<b>130</b>	<b>142</b>	<b>70</b>	<b>49</b>	<b>389</b>	<b>1596</b>	<b>99</b>	<b>4715</b>
Apprch %	22.7	7	70.3	1.1	92.2	6.6	54.4	26.8	18.8	18.7	76.6	4.8	
Total %	2	0.6	6.2	0.5	38.3	2.8	3	1.5	1	8.3	33.8	2.1	

Start Time	Elm St From North				Pleasant St From East				Old Pleasant St From South				Pleasant St From West				Int. Total	
	Left	Thru	Right	App. Total	Left	Thru	Right	App. Total	Left	Thru	Right	App. Total	Left	Thru	Right	App. Total		
<b>Peak Hour Analysis From 07:00 AM to 08:45 AM - Peak 1 of 1</b>																		
<b>Peak Hour for Entire Intersection Begins at 07:00 AM</b>																		
07:00 AM	<b>15</b>	0	42	57	1	216	<b>18</b>	235	25	<b>14</b>	<b>11</b>	<b>50</b>	153	62	202	9	273	615
07:15 AM	15	2	<b>53</b>	<b>70</b>	<b>3</b>	258	16	277	<b>27</b>	7	3	37	40	189	4	233	617	
07:30 AM	7	<b>4</b>	36	47	3	<b>285</b>	16	<b>304</b>	18	7	3	28	58	212	11	281	<b>660</b>	
07:45 AM	9	3	34	46	2	228	16	246	18	12	8	38	<b>64</b>	<b>222</b>	<b>17</b>	<b>303</b>	633	
Total Volume	46	9	165	220	9	987	66	1062	88	40	25	153	224	825	41	1090	2525	
% App. Total	20.9	4.1	75		0.8	92.9	6.2		57.5	26.1	16.3		20.6	75.7	3.8			
PHF	.767	.563	.778	.786	.750	.866	.917	.873	.815	.714	.568	.765	.875	.929	.603	.899	.956	

# Accurate Counts

978-664-2565

N/S Street : Elm St / Old Pleasant St  
 E/W Street : Pleasant Street  
 City/State : Bridgewater, MA  
 Weather : Clear

File Name : 202700B3  
 Site Code : 20270003  
 Start Date : 10/2/2024  
 Page No : 5

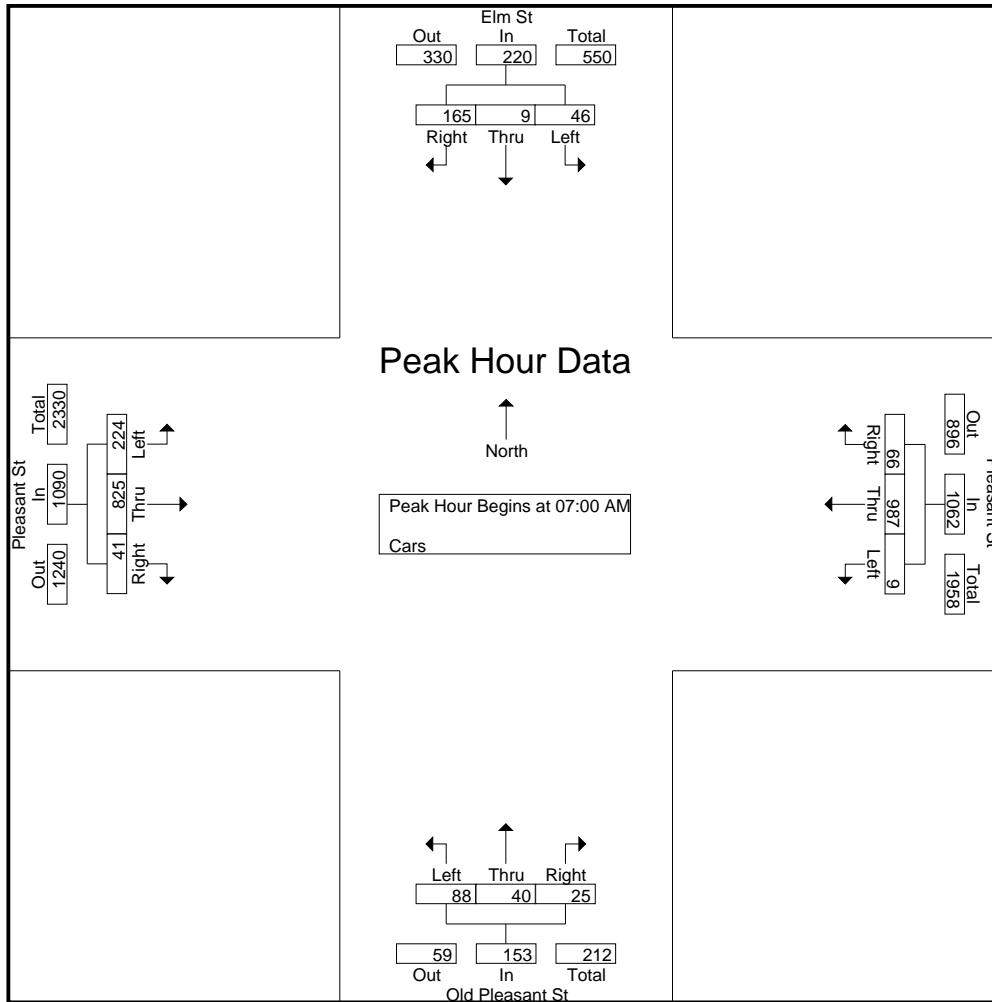

**Peak Hour Analysis From 07:00 AM to 08:45 AM - Peak 1 of 1**

**Peak Hour for Each Approach Begins at:**

	07:00 AM				07:15 AM				07:00 AM				07:30 AM			
+0 mins.	15	0	42	57	3	258	16	277	25	14	11	50	58	212	11	281
+15 mins.	15	2	53	70	3	285	16	304	27	7	3	37	64	222	17	303
+30 mins.	7	4	36	47	2	228	16	246	18	7	3	28	52	197	11	260
+45 mins.	9	3	34	46	3	250	13	266	18	12	8	38	45	206	22	273
Total Volume	46	9	165	220	11	1021	61	1093	88	40	25	153	219	837	61	1117
% App. Total	20.9	4.1	75		1	93.4	5.6		57.5	26.1	16.3		19.6	74.9	5.5	
PHF	.767	.563	.778	.786	.917	.896	.953	.899	.815	.714	.568	.765	.855	.943	.693	.922

# Accurate Counts

978-664-2565

File Name : 202700B3

Site Code : 20270003

Start Date : 10/2/2024

Page No : 6

N/S Street : Elm St / Old Pleasant St

E/W Street : Pleasant Street

City/State : Bridgewater, MA

Weather : Clear

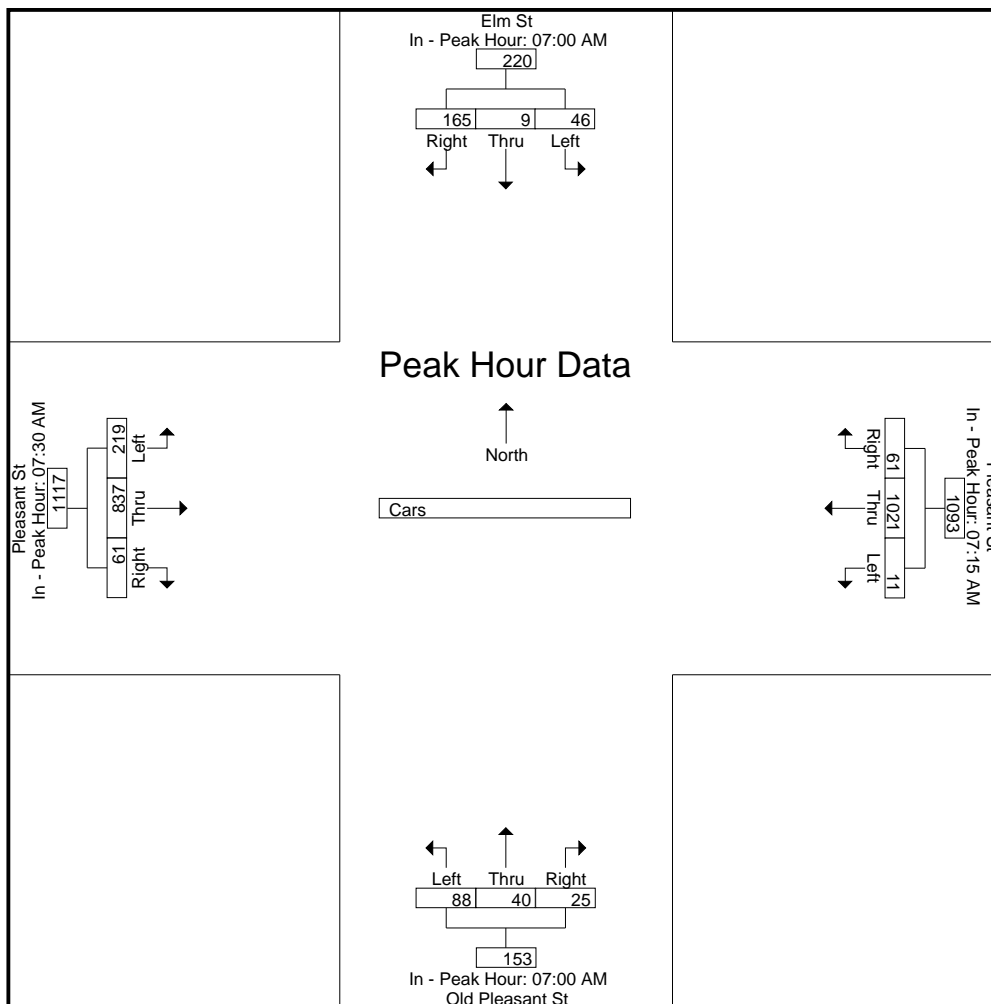

# Accurate Counts

978-664-2565

N/S Street : Elm St / Old Pleasant St  
 E/W Street : Pleasant Street  
 City/State : Bridgewater, MA  
 Weather : Clear

File Name : 202700B3  
 Site Code : 20270003  
 Start Date : 10/2/2024  
 Page No : 7

### Groups Printed- Trucks

Start Time	Elm St From North			Pleasant St From East			Old Pleasant St From South			Pleasant St From West			Int. Total
	Left	Thru	Right	Left	Thru	Right	Left	Thru	Right	Left	Thru	Right	
07:00 AM	2	0	9	0	11	0	0	0	1	4	16	1	44
07:15 AM	3	1	6	0	11	2	1	0	0	4	16	0	44
07:30 AM	6	4	16	0	11	0	0	0	0	4	11	1	53
07:45 AM	1	0	1	1	9	2	0	0	0	5	9	0	28
<b>Total</b>	<b>12</b>	<b>5</b>	<b>32</b>	<b>1</b>	<b>42</b>	<b>4</b>	<b>1</b>	<b>0</b>	<b>1</b>	<b>17</b>	<b>52</b>	<b>2</b>	<b>169</b>
08:00 AM	2	0	6	0	7	1	0	0	0	2	10	0	28
08:15 AM	1	0	7	1	11	2	0	0	0	6	11	1	40
08:30 AM	4	0	10	1	11	1	0	0	0	3	18	1	49
08:45 AM	5	0	3	0	7	2	0	0	1	4	10	0	32
<b>Total</b>	<b>12</b>	<b>0</b>	<b>26</b>	<b>2</b>	<b>36</b>	<b>6</b>	<b>0</b>	<b>0</b>	<b>1</b>	<b>15</b>	<b>49</b>	<b>2</b>	<b>149</b>
<b>Grand Total</b>	<b>24</b>	<b>5</b>	<b>58</b>	<b>3</b>	<b>78</b>	<b>10</b>	<b>1</b>	<b>0</b>	<b>2</b>	<b>32</b>	<b>101</b>	<b>4</b>	<b>318</b>
Apprch %	27.6	5.7	66.7	3.3	85.7	11	33.3	0	66.7	23.4	73.7	2.9	
Total %	7.5	1.6	18.2	0.9	24.5	3.1	0.3	0	0.6	10.1	31.8	1.3	

Start Time	Elm St From North				Pleasant St From East				Old Pleasant St From South				Pleasant St From West				Int. Total
	Left	Thru	Right	App. Total	Left	Thru	Right	App. Total	Left	Thru	Right	App. Total	Left	Thru	Right	App. Total	
<b>Peak Hour Analysis From 07:00 AM to 08:45 AM - Peak 1 of 1</b>																	
<b>Peak Hour for Entire Intersection Begins at 07:00 AM</b>																	
07:00 AM	2	0	9	11	0	11	0	11	0	0	1	1	4	16	1	21	44
07:15 AM	3	1	6	10	0	11	2	13	1	0	0	1	4	16	0	20	44
07:30 AM	6	4	16	26	0	11	0	11	0	0	0	0	4	11	1	16	53
07:45 AM	1	0	1	2	1	9	2	12	0	0	0	0	5	9	0	14	28
<b>Total Volume</b>	<b>12</b>	<b>5</b>	<b>32</b>	<b>49</b>	<b>1</b>	<b>42</b>	<b>4</b>	<b>47</b>	<b>1</b>	<b>0</b>	<b>1</b>	<b>2</b>	<b>17</b>	<b>52</b>	<b>2</b>	<b>71</b>	<b>169</b>
<b>% App. Total</b>	<b>24.5</b>	<b>10.2</b>	<b>65.3</b>		<b>2.1</b>	<b>89.4</b>	<b>8.5</b>		<b>50</b>	<b>0</b>	<b>50</b>		<b>23.9</b>	<b>73.2</b>	<b>2.8</b>		
PHF	.500	.313	.500	.471	.250	.955	.500	.904	.250	.000	.250	.500	.850	.813	.500	.845	.797

# Accurate Counts

978-664-2565

N/S Street : Elm St / Old Pleasant St  
 E/W Street : Pleasant Street  
 City/State : Bridgewater, MA  
 Weather : Clear

File Name : 202700B3  
 Site Code : 20270003  
 Start Date : 10/2/2024  
 Page No : 8

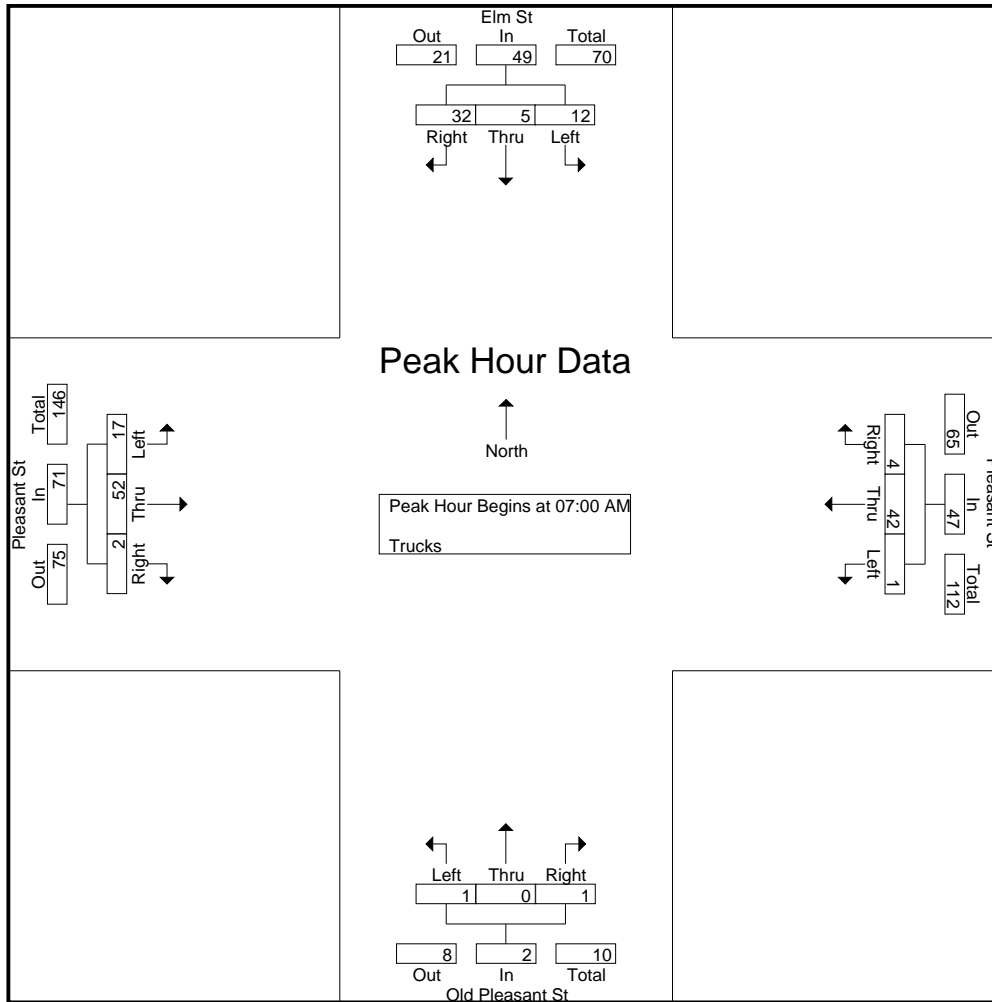

**Peak Hour Analysis From 07:00 AM to 08:45 AM - Peak 1 of 1**

**Peak Hour for Each Approach Begins at:**

	07:00 AM				07:00 AM				07:00 AM				07:00 AM			
+0 mins.	2	0	9	11	0	11	0	11	0	0	1	1	4	16	1	21
+15 mins.	3	1	6	10	0	11	2	13	1	0	0	1	4	16	0	20
+30 mins.	6	4	16	26	0	11	0	11	0	0	0	0	4	11	1	16
+45 mins.	1	0	1	2	1	9	2	12	0	0	0	0	5	9	0	14
<b>Total Volume</b>	12	5	32	49	1	42	4	47	1	0	1	2	17	52	2	71
<b>% App. Total</b>	24.5	10.2	65.3		2.1	89.4	8.5		50	0	50		23.9	73.2	2.8	
<b>PHF</b>	.500	.313	.500	.471	.250	.955	.500	.904	.250	.000	.250	.500	.850	.813	.500	.845



# Accurate Counts

978-664-2565

N/S Street : Elm St / Old Pleasant St

E/W Street : Pleasant Street

City/State : Bridgewater, MA

Weather : Clear

File Name : 202700B3

Site Code : 20270003

Start Date : 10/2/2024

Page No : 9

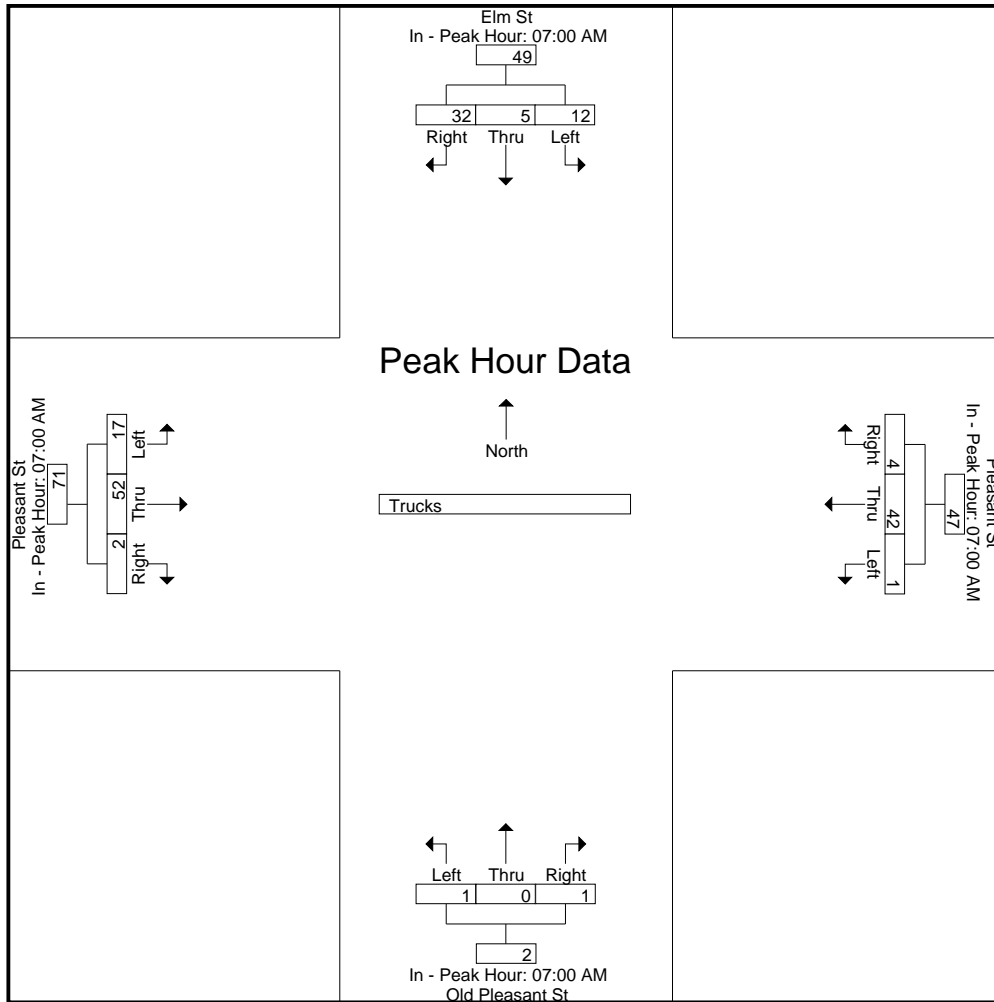

# Accurate Counts

978-664-2565

N/S Street : Elm St / Old Pleasant St

E/W Street : Pleasant Street

City/State : Bridgewater, MA

Weather : Clear

File Name : 202700B3

Site Code : 20270003

Start Date : 10/2/2024

Page No : 10

## Groups Printed- Bikes Peds

Start Time	Elm St From North				Pleasant St From East				Old Pleasant St From South				Pleasant St From West				Exclu. Total	Inclu. Total	Int. Total
	Left	Thru	Right	Peds	Left	Thru	Right	Peds	Left	Thru	Right	Peds	Left	Thru	Right	Peds			
07:00 AM	0	0	0	0	0	0	0	0	0	0	0	0	0	0	0	0	0	0	0
07:15 AM	0	0	0	0	0	0	0	0	0	0	0	0	0	0	0	0	0	0	0
07:30 AM	0	0	0	0	0	0	0	1	0	0	0	0	0	0	0	0	1	0	1
07:45 AM	0	0	0	0	0	0	0	0	0	0	0	0	0	0	0	0	0	0	0
<b>Total</b>	0	0	0	0	0	0	0	1	0	0	0	0	0	0	0	0	1	0	1
08:00 AM	0	0	0	0	0	0	0	0	0	0	0	0	0	0	0	0	0	0	0
08:15 AM	0	0	0	0	0	0	0	1	0	0	0	0	0	0	0	0	1	0	1
08:30 AM	0	0	0	0	0	0	0	1	0	0	0	0	0	0	0	0	1	0	1
08:45 AM	0	0	0	0	0	0	0	0	0	0	0	0	0	0	0	0	0	0	0
<b>Total</b>	0	0	0	0	0	0	0	2	0	0	0	0	0	0	0	0	2	0	2
<b>Grand Total</b>	0	0	0	0	0	0	0	3	0	0	0	0	0	0	0	0	3	0	3
Apprch %	0	0	0		0	0	0		0	0	0		0	0	0				
Total %																	100	0	

Start Time	Elm St From North				Pleasant St From East				Old Pleasant St From South				Pleasant St From West				Int. Total	
	Left	Thru	Right	App. Total	Left	Thru	Right	App. Total	Left	Thru	Right	App. Total	Left	Thru	Right	App. Total		
Peak Hour Analysis From 07:00 AM to 08:45 AM - Peak 1 of 1																		
Peak Hour for Entire Intersection Begins at 07:00 AM																		
07:00 AM	0	0	0	0	0	0	0	0	0	0	0	0	0	0	0	0	0	0
07:15 AM	0	0	0	0	0	0	0	0	0	0	0	0	0	0	0	0	0	0
07:30 AM	0	0	0	0	0	0	0	0	0	0	0	0	0	0	0	0	0	0
07:45 AM	0	0	0	0	0	0	0	0	0	0	0	0	0	0	0	0	0	0
<b>Total Volume</b>	0	0	0	0	0	0	0	0	0	0	0	0	0	0	0	0	0	0
<b>% App. Total</b>	0	0	0		0	0	0		0	0	0		0	0	0			
PHF	.000	.000	.000	.000	.000	.000	.000	.000	.000	.000	.000	.000	.000	.000	.000	.000	.000	.000

# Accurate Counts

978-664-2565

N/S Street : Elm St / Old Pleasant St  
 E/W Street : Pleasant Street  
 City/State : Bridgewater, MA  
 Weather : Clear

File Name : 202700B3  
 Site Code : 20270003  
 Start Date : 10/2/2024  
 Page No : 11

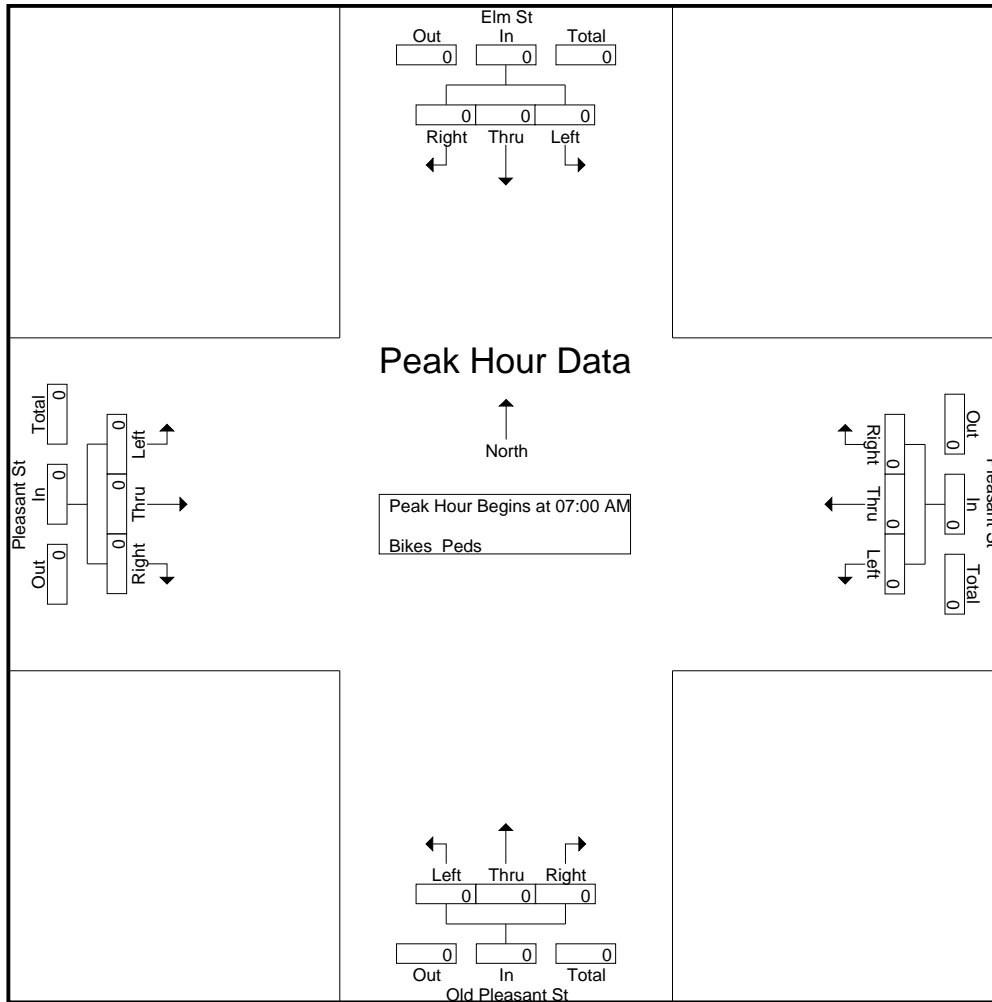

**Peak Hour Analysis From 07:00 AM to 08:45 AM - Peak 1 of 1**

**Peak Hour for Each Approach Begins at:**

	07:00 AM				07:00 AM				07:00 AM				07:00 AM			
+0 mins.	0	0	0	0	0	0	0	0	0	0	0	0	0	0	0	0
+15 mins.	0	0	0	0	0	0	0	0	0	0	0	0	0	0	0	0
+30 mins.	0	0	0	0	0	0	0	0	0	0	0	0	0	0	0	0
+45 mins.	0	0	0	0	0	0	0	0	0	0	0	0	0	0	0	0
Total Volume	0	0	0	0	0	0	0	0	0	0	0	0	0	0	0	0
% App. Total	0	0	0	0	0	0	0	0	0	0	0	0	0	0	0	0
PHF	.000	.000	.000	.000	.000	.000	.000	.000	.000	.000	.000	.000	.000	.000	.000	.000

# Accurate Counts

978-664-2565

File Name : 202700B3

Site Code : 20270003

Start Date : 10/2/2024

Page No : 12

N/S Street : Elm St / Old Pleasant St

E/W Street : Pleasant Street

City/State : Bridgewater, MA

Weather : Clear

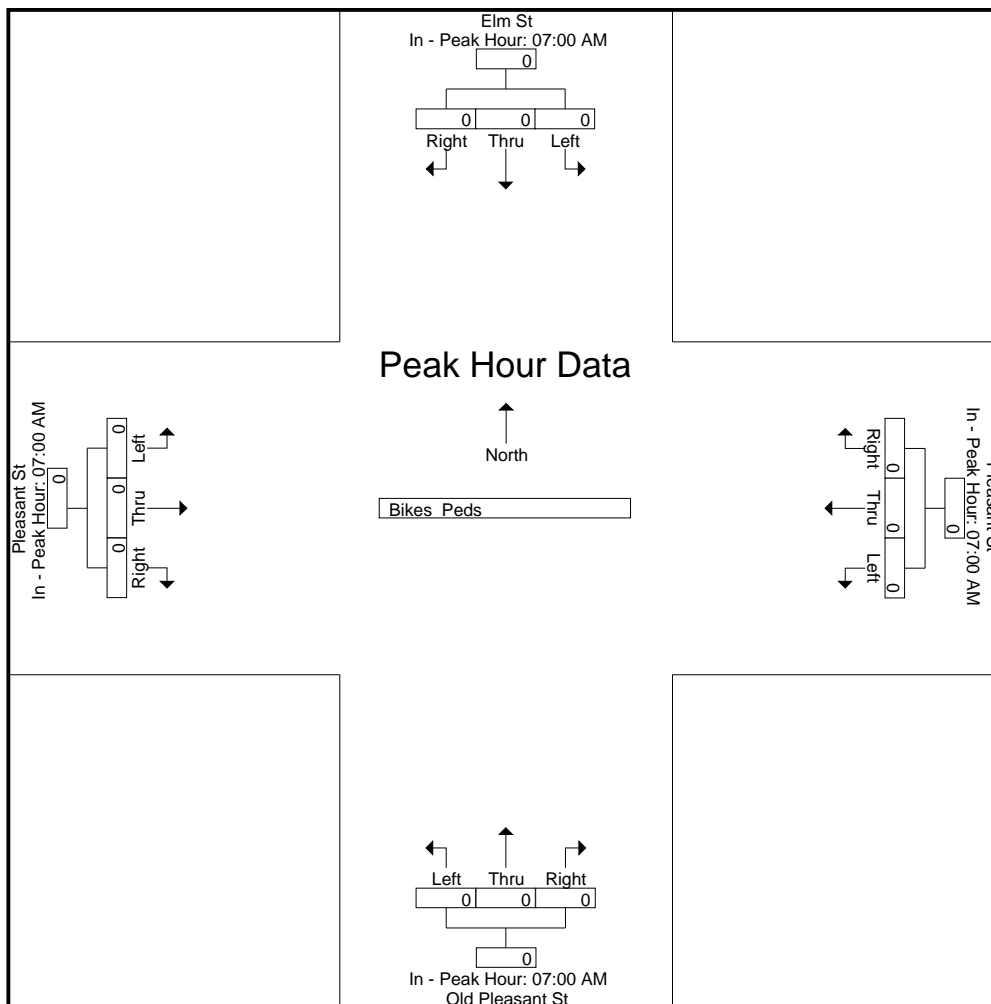

# Accurate Counts

978-664-2565

N/S Street : Elm St / Old Pleasant St

E/W Street : Pleasant Street

City/State : Bridgewater, MA

Weather : Clear

File Name : 202700B3

Site Code : 20270003

Start Date : 10/2/2024

Page No : 1

### Groups Printed- Cars - Trucks

Start Time	Elm St From North			Pleasant St From East			Old Pleasant St From South			Pleasant St From West			Int. Total
	Left	Thru	Right	Left	Thru	Right	Left	Thru	Right	Left	Thru	Right	
04:00 PM	15	27	54	5	189	13	13	2	4	49	238	64	673
04:15 PM	12	31	39	3	230	12	12	8	5	45	246	88	731
04:30 PM	13	30	44	10	199	6	23	5	2	35	216	67	650
04:45 PM	14	25	50	3	197	15	19	6	2	78	227	90	726
<b>Total</b>	<b>54</b>	<b>113</b>	<b>187</b>	<b>21</b>	<b>815</b>	<b>46</b>	<b>67</b>	<b>21</b>	<b>13</b>	<b>207</b>	<b>927</b>	<b>309</b>	<b>2780</b>
05:00 PM	14	21	59	4	169	10	11	1	6	57	223	80	655
05:15 PM	10	23	53	7	222	7	16	4	3	37	247	70	699
05:30 PM	12	21	35	6	181	8	15	3	4	36	236	87	644
05:45 PM	14	13	37	4	173	6	21	2	0	34	262	56	622
<b>Total</b>	<b>50</b>	<b>78</b>	<b>184</b>	<b>21</b>	<b>745</b>	<b>31</b>	<b>63</b>	<b>10</b>	<b>13</b>	<b>164</b>	<b>968</b>	<b>293</b>	<b>2620</b>
<b>Grand Total</b>	<b>104</b>	<b>191</b>	<b>371</b>	<b>42</b>	<b>1560</b>	<b>77</b>	<b>130</b>	<b>31</b>	<b>26</b>	<b>371</b>	<b>1895</b>	<b>602</b>	<b>5400</b>
Apprch %	15.6	28.7	55.7	2.5	92.9	4.6	69.5	16.6	13.9	12.9	66.1	21	
Total %	1.9	3.5	6.9	0.8	28.9	1.4	2.4	0.6	0.5	6.9	35.1	11.1	
Cars	100	189	362	40	1535	70	130	31	25	346	1847	596	5271
% Cars	96.2	99	97.6	95.2	98.4	90.9	100	100	96.2	93.3	97.5	99	97.6
Trucks	4	2	9	2	25	7	0	0	1	25	48	6	129
% Trucks	3.8	1	2.4	4.8	1.6	9.1	0	0	3.8	6.7	2.5	1	2.4

Start Time	Elm St From North				Pleasant St From East				Old Pleasant St From South				Pleasant St From West				Int. Total
	Left	Thru	Right	App. Total	Left	Thru	Right	App. Total	Left	Thru	Right	App. Total	Left	Thru	Right	App. Total	
Peak Hour Analysis From 04:00 PM to 05:45 PM - Peak 1 of 1																	
Peak Hour for Entire Intersection Begins at 04:00 PM																	
04:00 PM	<b>15</b>	27	<b>54</b>	<b>96</b>	5	189	13	207	13	2	4	19	49	238	64	351	673
04:15 PM	12	<b>31</b>	39	82	3	<b>230</b>	12	<b>245</b>	12	<b>8</b>	<b>5</b>	25	45	<b>246</b>	88	379	<b>731</b>
04:30 PM	13	30	44	87	<b>10</b>	199	6	215	<b>23</b>	5	2	<b>30</b>	35	216	67	318	650
04:45 PM	14	25	50	89	3	197	<b>15</b>	215	19	6	2	27	<b>78</b>	227	<b>90</b>	<b>395</b>	726
<b>Total Volume</b>	<b>54</b>	<b>113</b>	<b>187</b>	<b>354</b>	<b>21</b>	<b>815</b>	<b>46</b>	<b>882</b>	<b>67</b>	<b>21</b>	<b>13</b>	<b>101</b>	<b>207</b>	<b>927</b>	<b>309</b>	<b>1443</b>	<b>2780</b>
% App. Total	15.3	31.9	52.8		2.4	92.4	5.2		66.3	20.8	12.9		14.3	64.2	21.4		
PHF	.900	.911	.866	.922	.525	.886	.767	.900	.728	.656	.650	.842	.663	.942	.858	.913	.951
Cars	50	112	182	344	19	801	40	860	67	21	12	100	192	896	307	1395	2699
% Cars	92.6	99.1	97.3	97.2	90.5	98.3	87.0	97.5	100	100	92.3	99.0	92.8	96.7	99.4	96.7	97.1
Trucks	4	1	5	10	2	14	6	22	0	0	1	1	15	31	2	48	81
% Trucks	7.4	0.9	2.7	2.8	9.5	1.7	13.0	2.5	0	0	7.7	1.0	7.2	3.3	0.6	3.3	2.9

# Accurate Counts

978-664-2565

N/S Street : Elm St / Old Pleasant St  
 E/W Street : Pleasant Street  
 City/State : Bridgewater, MA  
 Weather : Clear

File Name : 202700B3  
 Site Code : 20270003  
 Start Date : 10/2/2024  
 Page No : 2

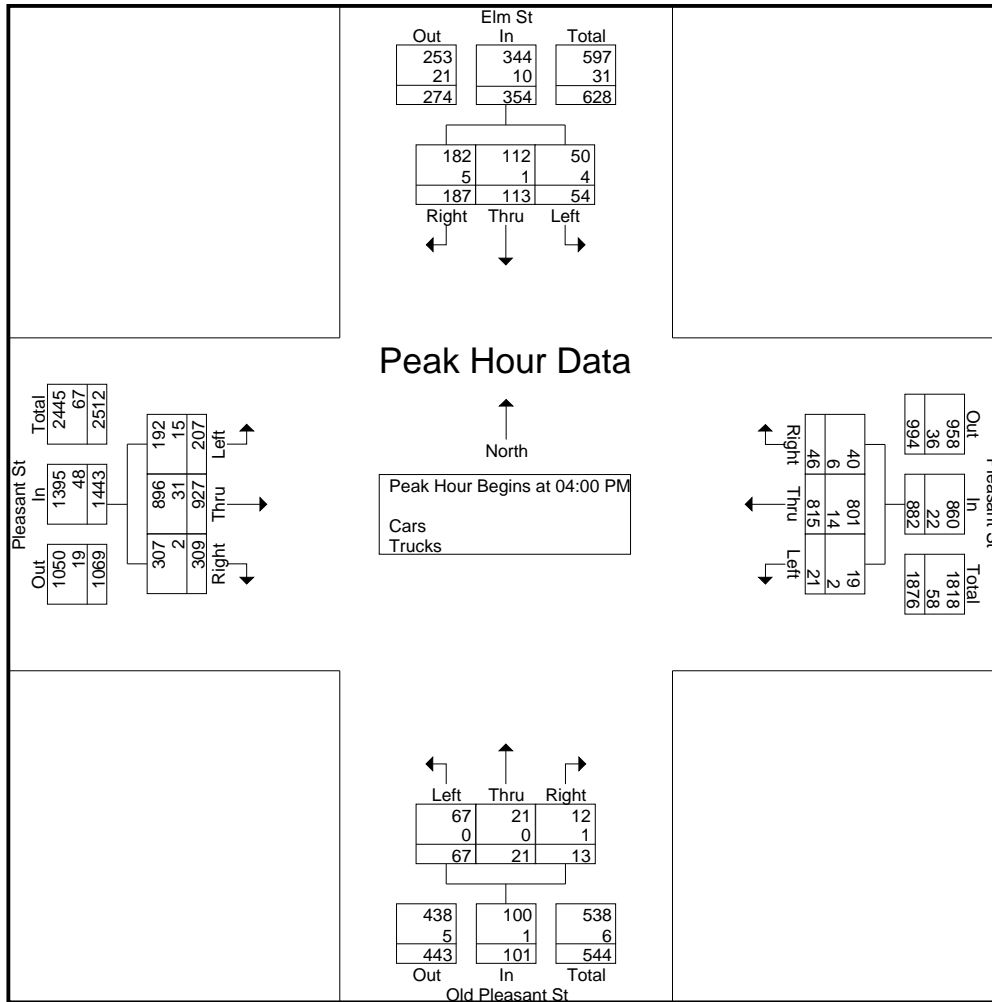

**Peak Hour Analysis From 04:00 PM to 05:45 PM - Peak 1 of 1**

**Peak Hour for Each Approach Begins at:**

	04:30 PM				04:00 PM				04:00 PM				04:45 PM			
+0 mins.	13	<b>30</b>	44	87	5	189	13	207	13	2	4	19	<b>78</b>	227	<b>90</b>	<b>395</b>
+15 mins.	<b>14</b>	25	50	89	3	<b>230</b>	12	<b>245</b>	12	<b>8</b>	<b>5</b>	25	57	223	80	360
+30 mins.	14	21	<b>59</b>	<b>94</b>	<b>10</b>	199	6	215	<b>23</b>	5	2	<b>30</b>	37	<b>247</b>	70	354
+45 mins.	10	23	53	86	3	197	<b>15</b>	215	19	6	2	27	36	236	87	359
Total Volume	51	99	206	356	21	815	46	882	67	21	13	101	208	933	327	1468
% App. Total	14.3	27.8	57.9		2.4	92.4	5.2		66.3	20.8	12.9		14.2	63.6	22.3	
PHF	.911	.825	.873	.947	.525	.886	.767	.900	.728	.656	.650	.842	.667	.944	.908	.929
Cars	50	98	197	345	19	801	40	860	67	21	12	100	196	916	323	1435
% Cars	98	99	95.6	96.9	90.5	98.3	87	97.5	100	100	92.3	99	94.2	98.2	98.8	97.8
Trucks	1	1	9	11	2	14	6	22	0	0	1	1	12	17	4	33
% Trucks	2	1	4.4	3.1	9.5	1.7	13	2.5	0	0	7.7	1	5.8	1.8	1.2	2.2

# Accurate Counts

978-664-2565

File Name : 202700B3

Site Code : 20270003

Start Date : 10/2/2024

Page No : 3

N/S Street : Elm St / Old Pleasant St

E/W Street : Pleasant Street

City/State : Bridgewater, MA

Weather : Clear

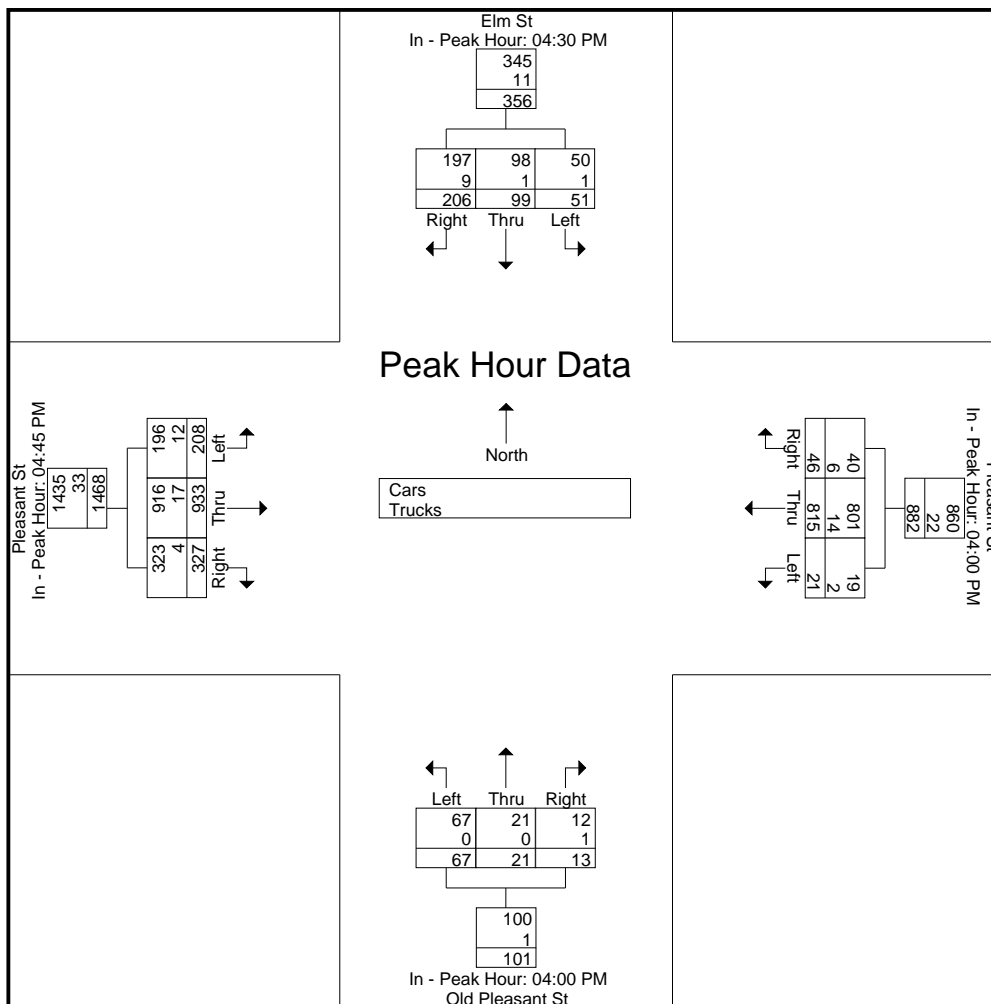

# Accurate Counts

978-664-2565

N/S Street : Elm St / Old Pleasant St

E/W Street : Pleasant Street

City/State : Bridgewater, MA

Weather : Clear

File Name : 202700B3

Site Code : 20270003

Start Date : 10/2/2024

Page No : 4

## Groups Printed- Cars

Start Time	Elm St From North			Pleasant St From East			Old Pleasant St From South			Pleasant St From West			Int. Total
	Left	Thru	Right	Left	Thru	Right	Left	Thru	Right	Left	Thru	Right	
04:00 PM	14	26	54	4	186	10	13	2	4	43	228	63	647
04:15 PM	10	31	39	3	225	10	12	8	4	43	235	87	707
04:30 PM	12	30	42	9	196	6	23	5	2	31	211	67	634
04:45 PM	14	25	47	3	194	14	19	6	2	75	222	90	711
<b>Total</b>	<b>50</b>	<b>112</b>	<b>182</b>	<b>19</b>	<b>801</b>	<b>40</b>	<b>67</b>	<b>21</b>	<b>12</b>	<b>192</b>	<b>896</b>	<b>307</b>	<b>2699</b>
05:00 PM	14	20	57	4	166	9	11	1	6	51	219	80	638
05:15 PM	10	23	51	7	218	7	16	4	3	37	242	70	688
05:30 PM	12	21	35	6	180	8	15	3	4	33	233	83	633
05:45 PM	14	13	37	4	170	6	21	2	0	33	257	56	613
<b>Total</b>	<b>50</b>	<b>77</b>	<b>180</b>	<b>21</b>	<b>734</b>	<b>30</b>	<b>63</b>	<b>10</b>	<b>13</b>	<b>154</b>	<b>951</b>	<b>289</b>	<b>2572</b>
<b>Grand Total</b>	<b>100</b>	<b>189</b>	<b>362</b>	<b>40</b>	<b>1535</b>	<b>70</b>	<b>130</b>	<b>31</b>	<b>25</b>	<b>346</b>	<b>1847</b>	<b>596</b>	<b>5271</b>
Apprch %	15.4	29	55.6	2.4	93.3	4.3	69.9	16.7	13.4	12.4	66.2	21.4	
Total %	1.9	3.6	6.9	0.8	29.1	1.3	2.5	0.6	0.5	6.6	35	11.3	

Start Time	Elm St From North				Pleasant St From East				Old Pleasant St From South				Pleasant St From West				Int. Total
	Left	Thru	Right	App. Total	Left	Thru	Right	App. Total	Left	Thru	Right	App. Total	Left	Thru	Right	App. Total	
Peak Hour Analysis From 04:00 PM to 05:45 PM - Peak 1 of 1																	
Peak Hour for Entire Intersection Begins at 04:00 PM																	
04:00 PM	<b>14</b>	26	<b>54</b>	<b>94</b>	4	186	10	200	13	2	<b>4</b>	19	43	228	63	334	647
04:15 PM	10	<b>31</b>	39	80	3	<b>225</b>	10	<b>238</b>	12	<b>8</b>	4	24	43	<b>235</b>	87	365	707
04:30 PM	12	30	42	84	<b>9</b>	196	6	211	<b>23</b>	5	2	<b>30</b>	31	211	67	309	634
04:45 PM	14	25	47	86	3	194	<b>14</b>	211	19	6	2	27	<b>75</b>	222	<b>90</b>	<b>387</b>	<b>711</b>
<b>Total Volume</b>	<b>50</b>	<b>112</b>	<b>182</b>	<b>344</b>	<b>19</b>	<b>801</b>	<b>40</b>	<b>860</b>	<b>67</b>	<b>21</b>	<b>12</b>	<b>100</b>	<b>192</b>	<b>896</b>	<b>307</b>	<b>1395</b>	<b>2699</b>
% App. Total	14.5	32.6	52.9		2.2	93.1	4.7		67	21	12		13.8	64.2	22		
PHF	.893	.903	.843	.915	.528	.890	.714	.903	.728	.656	.750	.833	.640	.953	.853	.901	.949



# Accurate Counts

978-664-2565

N/S Street : Elm St / Old Pleasant St  
 E/W Street : Pleasant Street  
 City/State : Bridgewater, MA  
 Weather : Clear

File Name : 202700B3  
 Site Code : 20270003  
 Start Date : 10/2/2024  
 Page No : 5

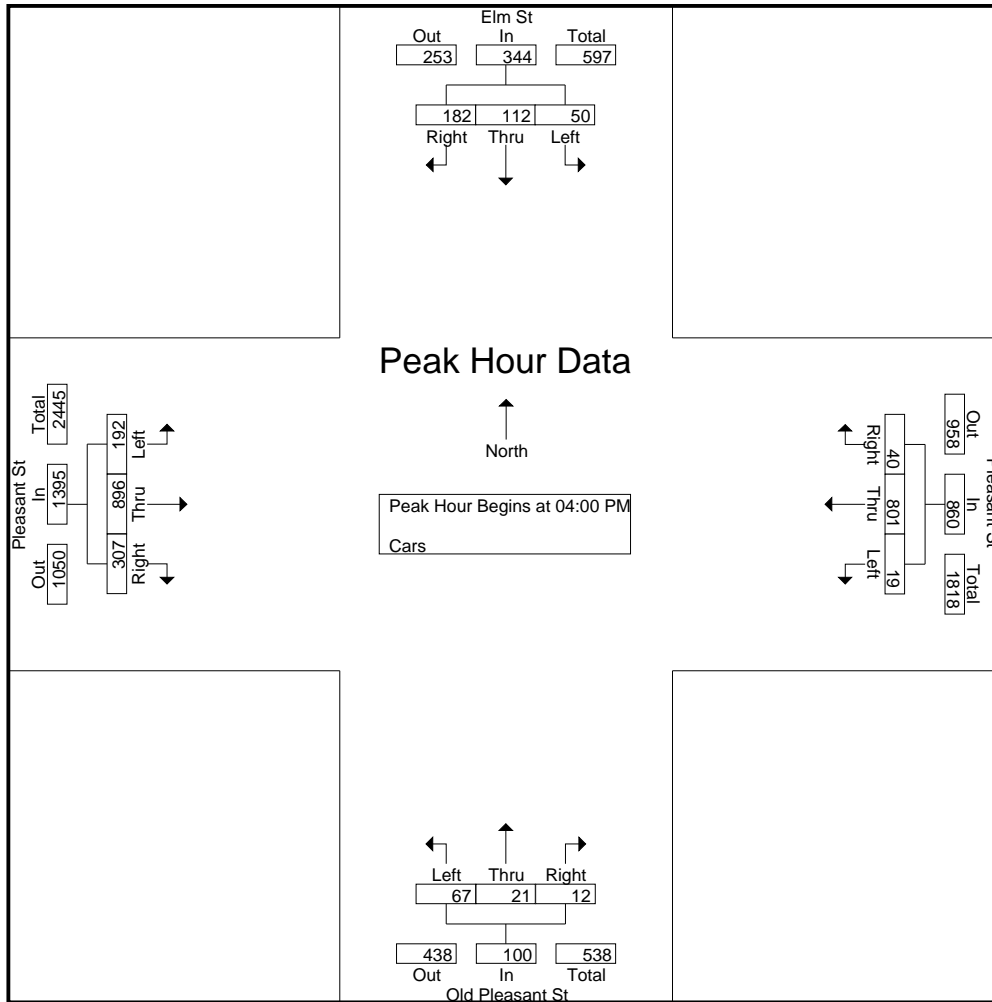

**Peak Hour Analysis From 04:00 PM to 05:45 PM - Peak 1 of 1**

**Peak Hour for Each Approach Begins at:**

	04:30 PM				04:00 PM				04:00 PM				04:45 PM			
+0 mins.	12	<b>30</b>	42	84	4	186	10	200	13	2	<b>4</b>	19	<b>75</b>	222	<b>90</b>	<b>387</b>
+15 mins.	<b>14</b>	25	47	86	3	<b>225</b>	10	<b>238</b>	12	<b>8</b>	4	24	51	219	80	350
+30 mins.	14	20	<b>57</b>	<b>91</b>	<b>9</b>	196	6	211	<b>23</b>	5	2	<b>30</b>	37	<b>242</b>	70	349
+45 mins.	10	23	51	84	3	194	<b>14</b>	211	19	6	2	27	33	233	83	349
Total Volume	50	98	197	345	19	801	40	860	67	21	12	100	196	916	323	1435
% App. Total	14.5	28.4	57.1		2.2	93.1	4.7		67	21	12		13.7	63.8	22.5	
PHF	.893	.817	.864	.948	.528	.890	.714	.903	.728	.656	.750	.833	.653	.946	.897	.927

# Accurate Counts

978-664-2565

N/S Street : Elm St / Old Pleasant St  
 E/W Street : Pleasant Street  
 City/State : Bridgewater, MA  
 Weather : Clear

File Name : 202700B3  
 Site Code : 20270003  
 Start Date : 10/2/2024  
 Page No : 6

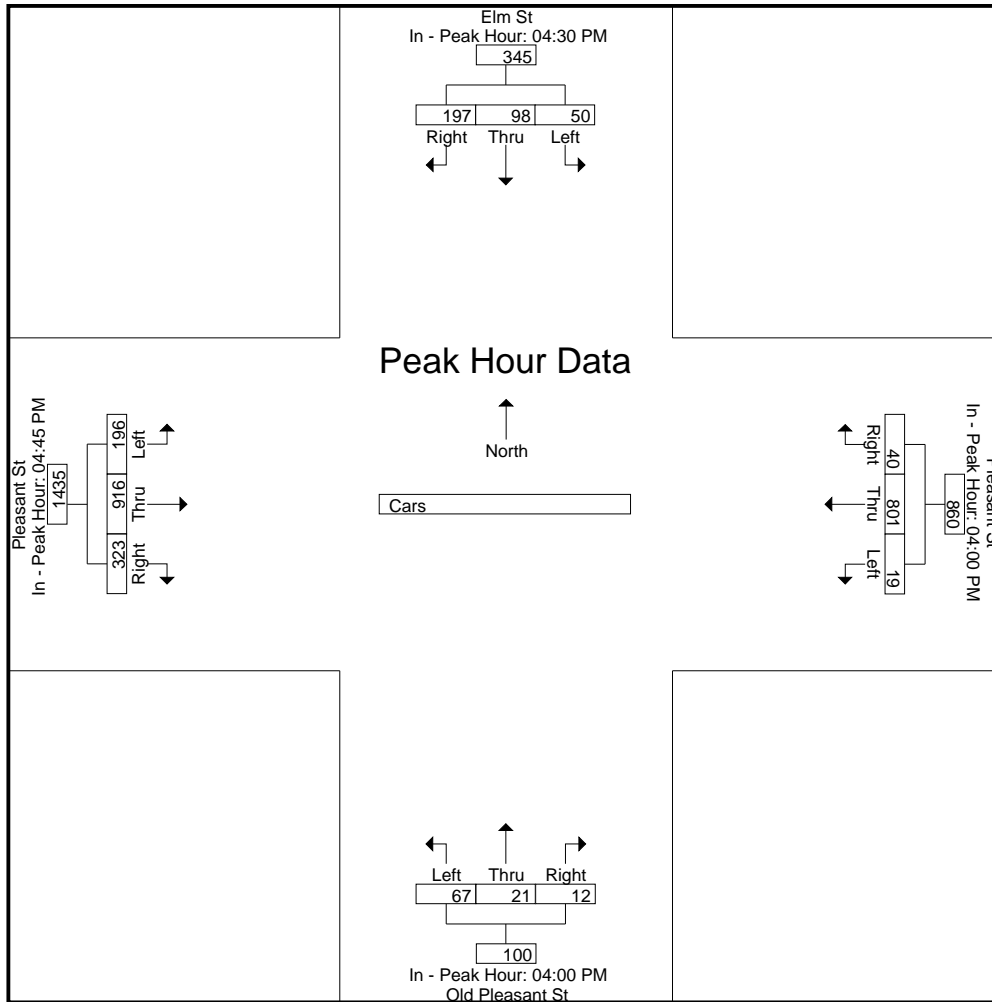

# Accurate Counts

978-664-2565

N/S Street : Elm St / Old Pleasant St

E/W Street : Pleasant Street

City/State : Bridgewater, MA

Weather : Clear

File Name : 202700B3

Site Code : 20270003

Start Date : 10/2/2024

Page No : 7

## Groups Printed- Trucks

Start Time	Elm St From North			Pleasant St From East			Old Pleasant St From South			Pleasant St From West			Int. Total
	Left	Thru	Right	Left	Thru	Right	Left	Thru	Right	Left	Thru	Right	
04:00 PM	1	1	0	1	3	3	0	0	0	6	10	1	26
04:15 PM	2	0	0	0	5	2	0	0	1	2	11	1	24
04:30 PM	1	0	2	1	3	0	0	0	0	4	5	0	16
04:45 PM	0	0	3	0	3	1	0	0	0	3	5	0	15
<b>Total</b>	<b>4</b>	<b>1</b>	<b>5</b>	<b>2</b>	<b>14</b>	<b>6</b>	<b>0</b>	<b>0</b>	<b>1</b>	<b>15</b>	<b>31</b>	<b>2</b>	<b>81</b>
05:00 PM	0	1	2	0	3	1	0	0	0	6	4	0	17
05:15 PM	0	0	2	0	4	0	0	0	0	0	5	0	11
05:30 PM	0	0	0	0	1	0	0	0	0	3	3	4	11
05:45 PM	0	0	0	0	3	0	0	0	0	1	5	0	9
<b>Total</b>	<b>0</b>	<b>1</b>	<b>4</b>	<b>0</b>	<b>11</b>	<b>1</b>	<b>0</b>	<b>0</b>	<b>0</b>	<b>10</b>	<b>17</b>	<b>4</b>	<b>48</b>
<b>Grand Total</b>	<b>4</b>	<b>2</b>	<b>9</b>	<b>2</b>	<b>25</b>	<b>7</b>	<b>0</b>	<b>0</b>	<b>1</b>	<b>25</b>	<b>48</b>	<b>6</b>	<b>129</b>
Apprch %	26.7	13.3	60	5.9	73.5	20.6	0	0	100	31.6	60.8	7.6	
Total %	3.1	1.6	7	1.6	19.4	5.4	0	0	0.8	19.4	37.2	4.7	

Start Time	Elm St From North				Pleasant St From East				Old Pleasant St From South				Pleasant St From West				Int. Total
	Left	Thru	Right	App. Total	Left	Thru	Right	App. Total	Left	Thru	Right	App. Total	Left	Thru	Right	App. Total	
<b>Peak Hour Analysis From 04:00 PM to 05:45 PM - Peak 1 of 1</b>																	
<b>Peak Hour for Entire Intersection Begins at 04:00 PM</b>																	
04:00 PM	1	1	0	2	1	3	3	7	0	0	0	0	6	10	1	17	26
04:15 PM	2	0	0	2	0	5	2	7	0	0	1	1	2	11	1	14	24
04:30 PM	1	0	2	3	1	3	0	4	0	0	0	0	4	5	0	9	16
04:45 PM	0	0	3	3	0	3	1	4	0	0	0	0	3	5	0	8	15
<b>Total Volume</b>	<b>4</b>	<b>1</b>	<b>5</b>	<b>10</b>	<b>2</b>	<b>14</b>	<b>6</b>	<b>22</b>	<b>0</b>	<b>0</b>	<b>1</b>	<b>1</b>	<b>15</b>	<b>31</b>	<b>2</b>	<b>48</b>	<b>81</b>
<b>% App. Total</b>	<b>40</b>	<b>10</b>	<b>50</b>		<b>9.1</b>	<b>63.6</b>	<b>27.3</b>		<b>0</b>	<b>0</b>	<b>100</b>		<b>31.2</b>	<b>64.6</b>	<b>4.2</b>		
PHF	.500	.250	.417	.833	.500	.700	.500	.786	.000	.000	.250	.250	.625	.705	.500	.706	.779

# Accurate Counts

978-664-2565

N/S Street : Elm St / Old Pleasant St  
 E/W Street : Pleasant Street  
 City/State : Bridgewater, MA  
 Weather : Clear

File Name : 202700B3  
 Site Code : 20270003  
 Start Date : 10/2/2024  
 Page No : 8

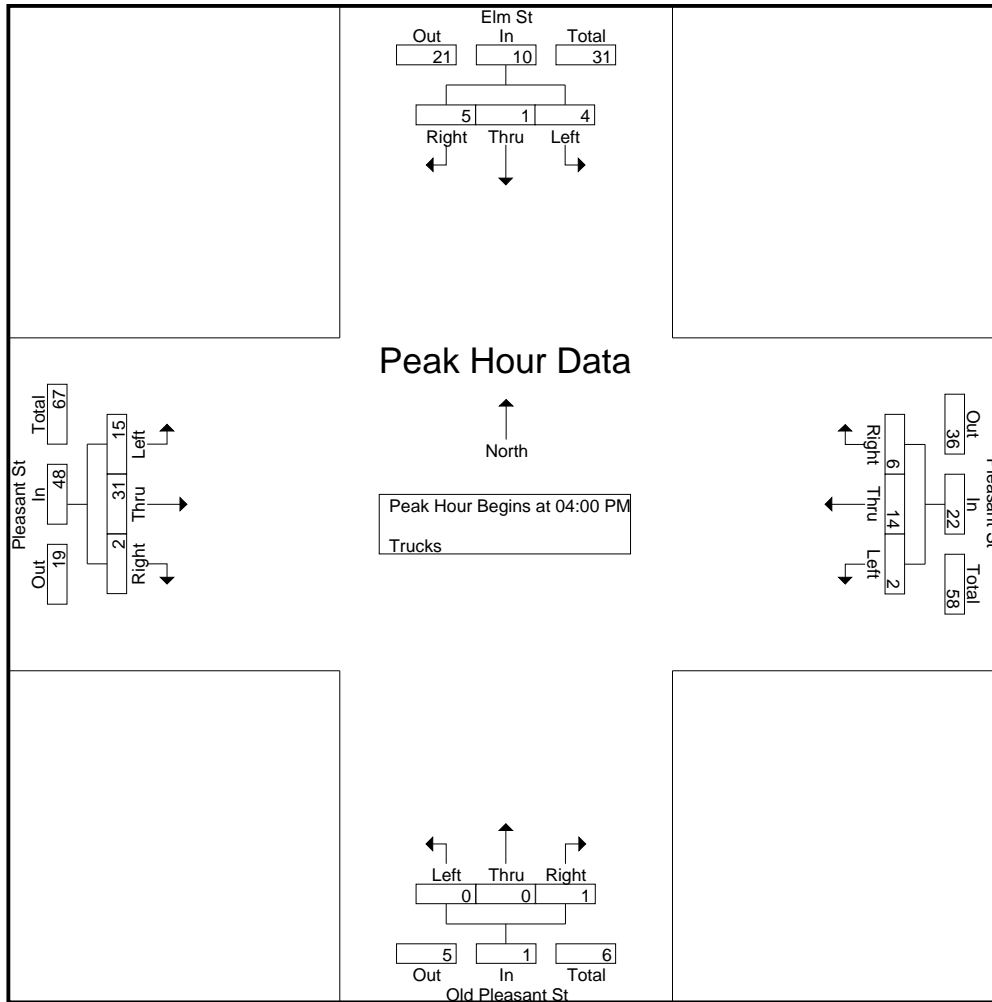

**Peak Hour Analysis From 04:00 PM to 05:45 PM - Peak 1 of 1**

Peak Hour for Each Approach Begins at:

	04:15 PM				04:00 PM				04:00 PM				04:00 PM			
+0 mins.	2	0	0	2	1	3	3	7	0	0	0	0	6	10	1	17
+15 mins.	1	0	2	3	0	5	2	7	0	0	1	1	2	11	1	14
+30 mins.	0	0	3	3	1	3	0	4	0	0	0	0	4	5	0	9
+45 mins.	0	1	2	3	0	3	1	4	0	0	0	0	3	5	0	8
Total Volume	3	1	7	11	2	14	6	22	0	0	1	1	15	31	2	48
% App. Total	27.3	9.1	63.6		9.1	63.6	27.3		0	0	100		31.2	64.6	4.2	
PHF	.375	.250	.583	.917	.500	.700	.500	.786	.000	.000	.250	.250	.625	.705	.500	.706

# Accurate Counts

978-664-2565

N/S Street : Elm St / Old Pleasant St

E/W Street : Pleasant Street

City/State : Bridgewater, MA

Weather : Clear

File Name : 202700B3

Site Code : 20270003

Start Date : 10/2/2024

Page No : 9

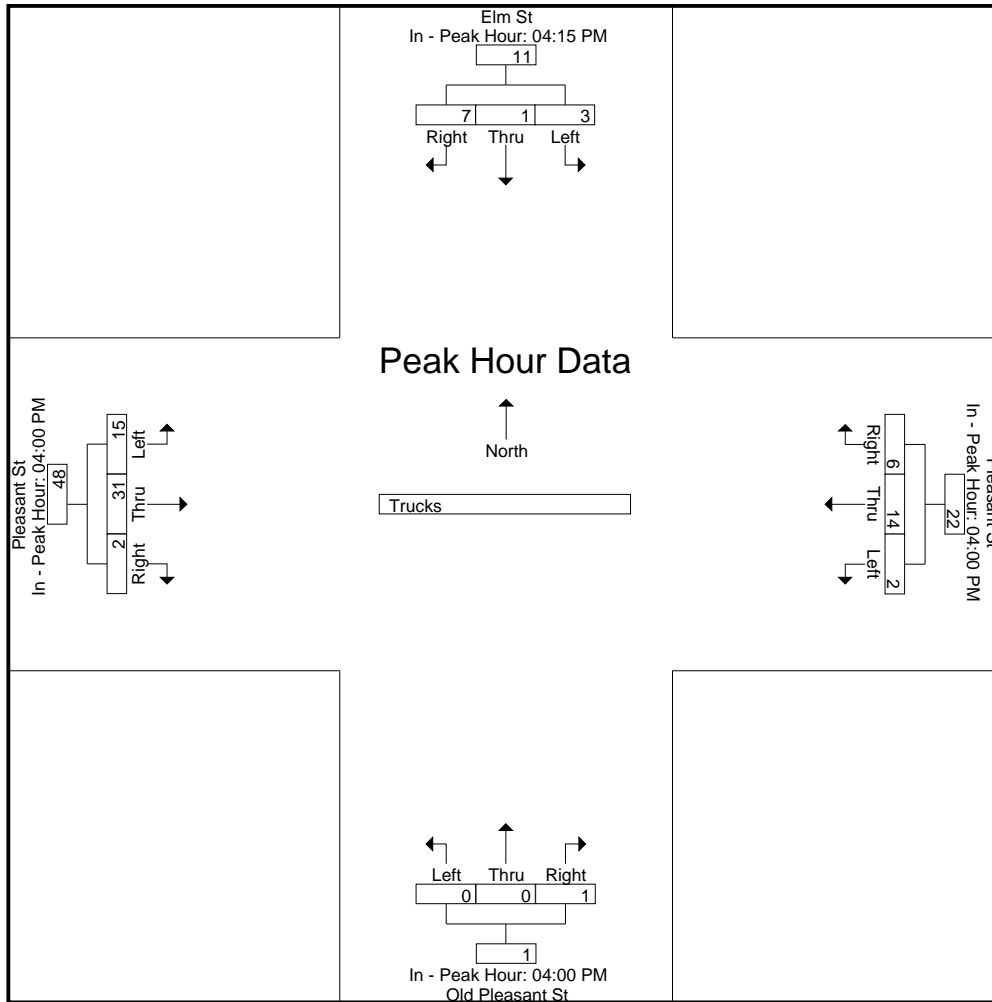

# Accurate Counts

978-664-2565

N/S Street : Elm St / Old Pleasant St

E/W Street : Pleasant Street

City/State : Bridgewater, MA

Weather : Clear

File Name : 202700B3

Site Code : 20270003

Start Date : 10/2/2024

Page No : 10

## Groups Printed- Bikes Peds

Start Time	Elm St From North				Pleasant St From East				Old Pleasant St From South				Pleasant St From West				Exclu. Total	Inclu. Total	Int. Total
	Left	Thru	Right	Peds	Left	Thru	Right	Peds	Left	Thru	Right	Peds	Left	Thru	Right	Peds			
04:00 PM	0	0	0	0	0	0	0	0	0	0	0	0	0	0	0	0	0	0	0
04:15 PM	0	0	0	0	0	0	0	0	0	0	0	0	0	0	0	0	0	0	0
04:30 PM	0	0	0	0	0	0	0	0	0	0	0	0	0	0	0	0	0	0	0
04:45 PM	0	0	0	0	0	0	0	0	0	0	0	0	0	0	0	0	0	0	0
<b>Total</b>	0	0	0	0	0	0	0	0	0	0	0	0	0	0	0	0	0	0	0
05:00 PM	0	0	0	0	0	0	0	0	0	0	0	0	0	0	0	0	0	0	0
05:15 PM	0	0	0	0	0	0	0	0	0	0	0	0	0	0	0	0	0	0	0
05:30 PM	0	0	0	0	0	0	0	0	0	0	0	0	0	0	0	0	0	0	0
05:45 PM	0	0	0	0	0	0	0	0	0	0	0	0	0	0	0	0	0	0	0
<b>Total</b>	0	0	0	0	0	0	0	0	0	0	0	0	0	0	0	0	0	0	0
<b>Grand Total</b>	0	0	0	0	0	0	0	0	0	0	0	0	0	0	0	0	0	0	0
Apprch %	0	0	0		0	0	0		0	0	0		0	0	0				
Total %																	0	0	

Start Time	Elm St From North				Pleasant St From East				Old Pleasant St From South				Pleasant St From West				Int. Total	
	Left	Thru	Right	App. Total	Left	Thru	Right	App. Total	Left	Thru	Right	App. Total	Left	Thru	Right	App. Total		
Peak Hour Analysis From 04:00 PM to 05:45 PM - Peak 1 of 1																		
Peak Hour for Entire Intersection Begins at 04:00 PM																		
04:00 PM	0	0	0	0	0	0	0	0	0	0	0	0	0	0	0	0	0	0
04:15 PM	0	0	0	0	0	0	0	0	0	0	0	0	0	0	0	0	0	0
04:30 PM	0	0	0	0	0	0	0	0	0	0	0	0	0	0	0	0	0	0
04:45 PM	0	0	0	0	0	0	0	0	0	0	0	0	0	0	0	0	0	0
<b>Total Volume</b>	0	0	0	0	0	0	0	0	0	0	0	0	0	0	0	0	0	0
<b>% App. Total</b>	0	0	0		0	0	0		0	0	0		0	0	0			
<b>PHF</b>	.000	.000	.000	.000	.000	.000	.000	.000	.000	.000	.000	.000	.000	.000	.000	.000	.000	.000

# Accurate Counts

978-664-2565

N/S Street : Elm St / Old Pleasant St

E/W Street : Pleasant Street

City/State : Bridgewater, MA

Weather : Clear

File Name : 202700B3

Site Code : 20270003

Start Date : 10/2/2024

Page No : 11

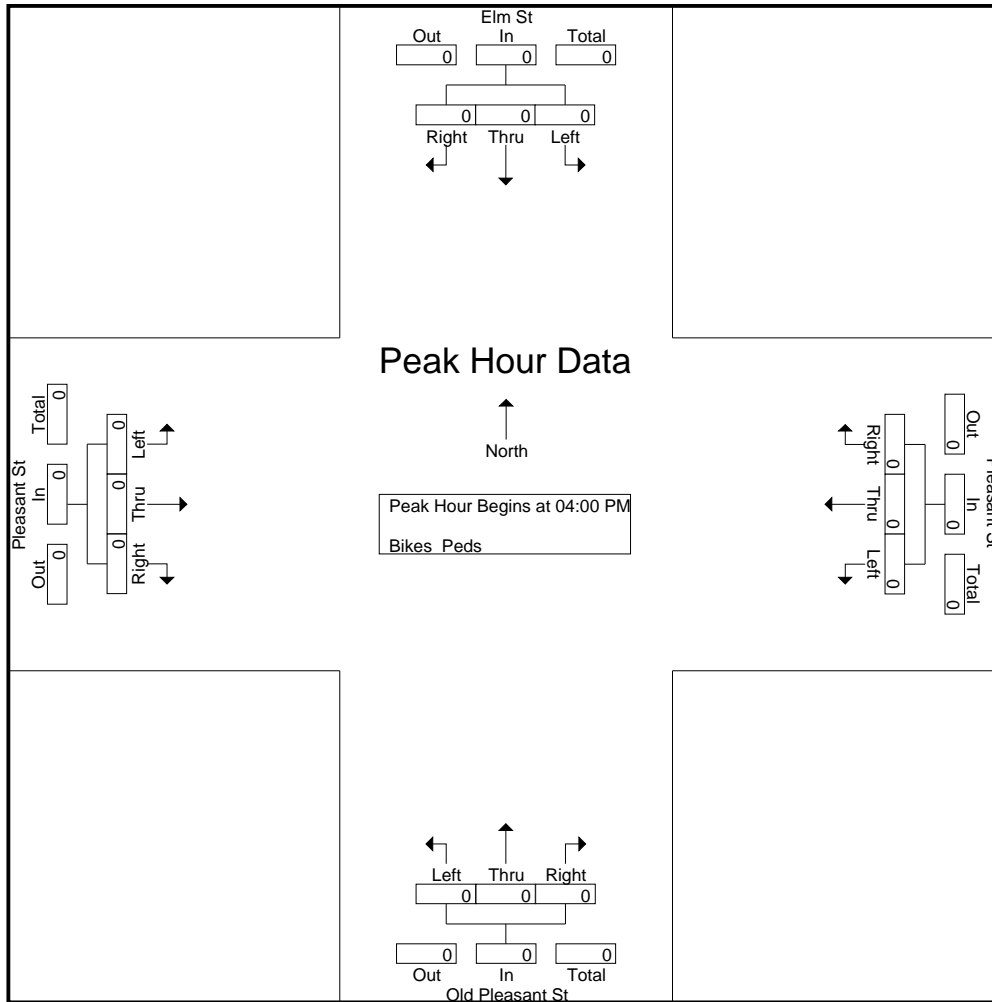

**Peak Hour Analysis From 04:00 PM to 05:45 PM - Peak 1 of 1**

**Peak Hour for Each Approach Begins at:**

	04:00 PM				04:00 PM				04:00 PM				04:00 PM			
+0 mins.	0	0	0	0	0	0	0	0	0	0	0	0	0	0	0	0
+15 mins.	0	0	0	0	0	0	0	0	0	0	0	0	0	0	0	0
+30 mins.	0	0	0	0	0	0	0	0	0	0	0	0	0	0	0	0
+45 mins.	0	0	0	0	0	0	0	0	0	0	0	0	0	0	0	0
Total Volume	0	0	0	0	0	0	0	0	0	0	0	0	0	0	0	0
% App. Total	0	0	0	0	0	0	0	0	0	0	0	0	0	0	0	0
PHF	.000	.000	.000	.000	.000	.000	.000	.000	.000	.000	.000	.000	.000	.000	.000	.000

# Accurate Counts

978-664-2565

N/S Street : Elm St / Old Pleasant St

E/W Street : Pleasant Street

City/State : Bridgewater, MA

Weather : Clear

File Name : 202700B3

Site Code : 20270003

Start Date : 10/2/2024

Page No : 12

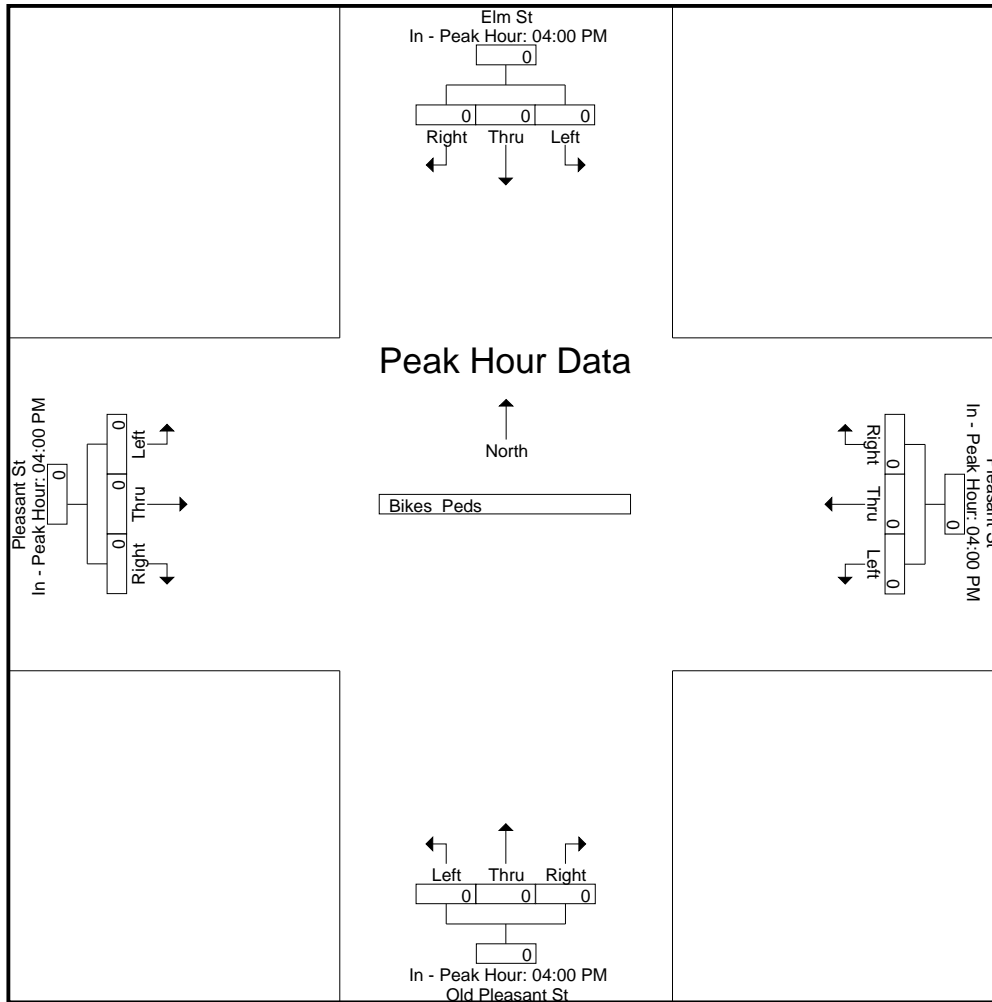



# Accurate Counts

978-664-2565

N/S Street : Jasmine Way / Prospect St

E/W Street : Pleasant Street

City/State : Bridgewater, MA

Weather : Clear

File Name : 202700B4

Site Code : 20270004

Start Date : 10/2/2024

Page No : 1

### Groups Printed- Cars - Trucks

Start Time	Jasmine Way From North			Pleasant St From East			Prospect St From South			Pleasant St From West			Int. Total
	Left	Thru	Right	Left	Thru	Right	Left	Thru	Right	Left	Thru	Right	
07:00 AM	10	0	2	4	189	16	51	11	13	10	210	19	535
07:15 AM	12	4	3	3	215	16	54	11	10	7	205	22	562
07:30 AM	1	2	2	7	221	16	56	5	9	3	204	21	547
07:45 AM	6	3	1	5	181	17	54	8	11	10	220	14	530
<b>Total</b>	<b>29</b>	<b>9</b>	<b>8</b>	<b>19</b>	<b>806</b>	<b>65</b>	<b>215</b>	<b>35</b>	<b>43</b>	<b>30</b>	<b>839</b>	<b>76</b>	<b>2174</b>
08:00 AM	3	4	6	3	202	13	58	12	13	10	200	17	541
08:15 AM	9	5	5	2	181	19	36	4	8	14	214	20	517
08:30 AM	5	0	5	6	159	15	44	4	7	6	207	19	477
08:45 AM	6	1	5	5	144	18	43	7	9	9	180	16	443
<b>Total</b>	<b>23</b>	<b>10</b>	<b>21</b>	<b>16</b>	<b>686</b>	<b>65</b>	<b>181</b>	<b>27</b>	<b>37</b>	<b>39</b>	<b>801</b>	<b>72</b>	<b>1978</b>
<b>Grand Total</b>	<b>52</b>	<b>19</b>	<b>29</b>	<b>35</b>	<b>1492</b>	<b>130</b>	<b>396</b>	<b>62</b>	<b>80</b>	<b>69</b>	<b>1640</b>	<b>148</b>	<b>4152</b>
Apprch %	52	19	29	2.1	90	7.8	73.6	11.5	14.9	3.7	88.3	8	
Total %	1.3	0.5	0.7	0.8	35.9	3.1	9.5	1.5	1.9	1.7	39.5	3.6	
Cars	50	19	27	33	1410	128	391	59	80	64	1537	138	3936
% Cars	96.2	100	93.1	94.3	94.5	98.5	98.7	95.2	100	92.8	93.7	93.2	94.8
Trucks	2	0	2	2	82	2	5	3	0	5	103	10	216
% Trucks	3.8	0	6.9	5.7	5.5	1.5	1.3	4.8	0	7.2	6.3	6.8	5.2

Start Time	Jasmine Way From North				Pleasant St From East				Prospect St From South				Pleasant St From West				Int. Total
	Left	Thru	Right	App. Total	Left	Thru	Right	App. Total	Left	Thru	Right	App. Total	Left	Thru	Right	App. Total	
Peak Hour Analysis From 07:00 AM to 08:45 AM - Peak 1 of 1																	
Peak Hour for Entire Intersection Begins at 07:15 AM																	
07:15 AM	<b>12</b>	<b>4</b>	<b>3</b>	<b>19</b>	3	215	16	234	54	11	10	75	7	205	<b>22</b>	234	<b>562</b>
07:30 AM	1	2	2	5	7	221	16	244	56	5	9	70	3	204	21	228	547
07:45 AM	6	3	1	10	5	181	17	203	54	8	11	73	<b>10</b>	<b>220</b>	14	<b>244</b>	530
08:00 AM	3	4	<b>6</b>	13	3	202	13	218	<b>58</b>	<b>12</b>	<b>13</b>	<b>83</b>	10	200	17	227	541
<b>Total Volume</b>	22	13	12	47	18	819	62	899	222	36	43	301	30	829	74	933	2180
% App. Total	46.8	27.7	25.5		2	91.1	6.9		73.8	12	14.3		3.2	88.9	7.9		
PHF	.458	.813	.500	.618	.643	.926	.912	.921	.957	.750	.827	.907	.750	.942	.841	.956	.970
Cars	20	13	12	45	17	777	61	855	221	34	43	298	26	779	72	877	2075
% Cars	90.9	100	100	95.7	94.4	94.9	98.4	95.1	99.5	94.4	100	99.0	86.7	94.0	97.3	94.0	95.2
Trucks	2	0	0	2	1	42	1	44	1	2	0	3	4	50	2	56	105
% Trucks	9.1	0	0	4.3	5.6	5.1	1.6	4.9	0.5	5.6	0	1.0	13.3	6.0	2.7	6.0	4.8

# Accurate Counts

978-664-2565

File Name : 202700B4

Site Code : 20270004

Start Date : 10/2/2024

Page No : 2

N/S Street : Jasmine Way / Prospect St

E/W Street : Pleasant Street

City/State : Bridgewater, MA

Weather : Clear

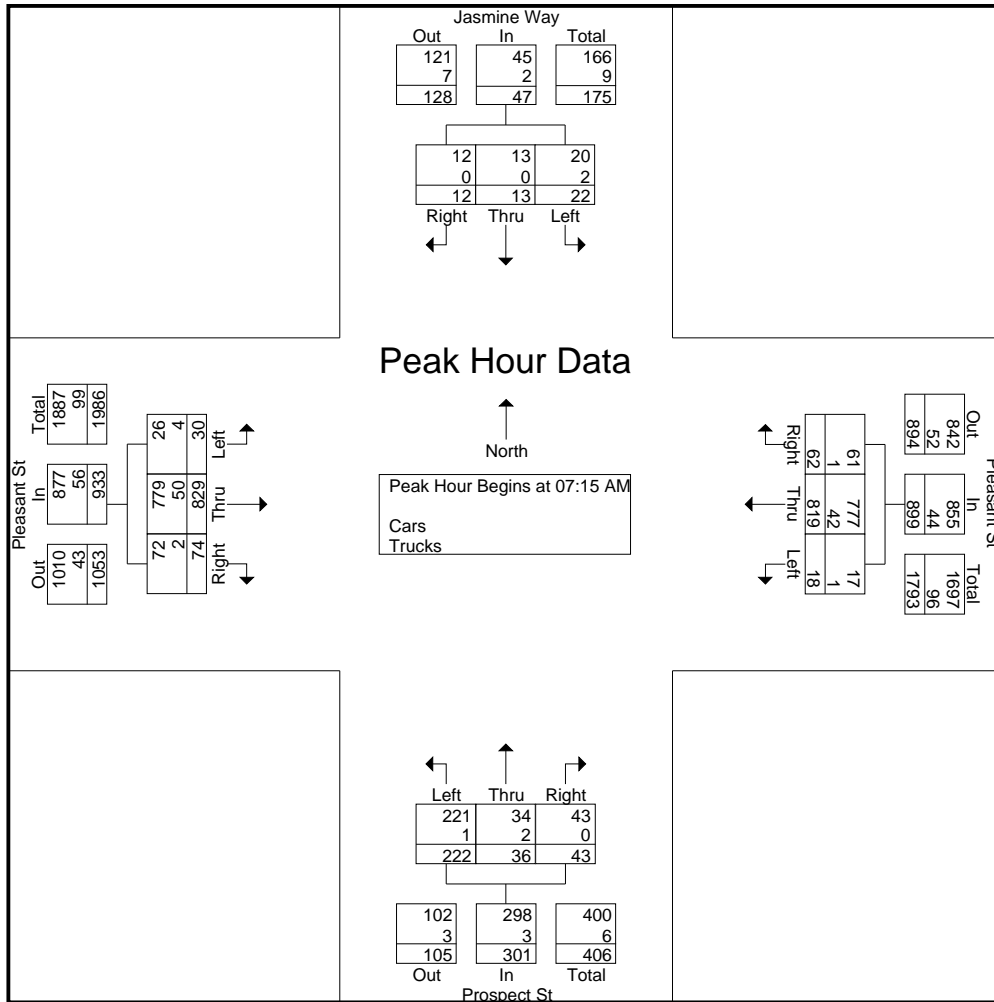

**Peak Hour Analysis From 07:00 AM to 08:45 AM - Peak 1 of 1**

**Peak Hour for Each Approach Begins at:**

	08:00 AM				07:15 AM				07:15 AM				07:45 AM			
+0 mins.	3	4	6	13	3	215	16	234	54	11	10	75	10	<b>220</b>	14	244
+15 mins.	9	5	5	19	7	<b>221</b>	16	<b>244</b>	56	5	9	70	10	200	17	227
+30 mins.	5	0	5	10	5	181	17	203	54	8	11	73	14	214	<b>20</b>	<b>248</b>
+45 mins.	6	1	5	12	3	202	13	218	<b>58</b>	<b>12</b>	<b>13</b>	<b>83</b>	6	207	19	232
Total Volume	23	10	21	54	18	819	62	899	222	36	43	301	40	841	70	951
% App. Total	42.6	18.5	38.9		2	91.1	6.9		73.8	12	14.3		4.2	88.4	7.4	
PHF	.639	.500	.875	.711	.643	.926	.912	.921	.957	.750	.827	.907	.714	.956	.875	.959
Cars	23	10	19	52	17	777	61	855	221	34	43	298	37	797	65	899
% Cars	100	100	90.5	96.3	94.4	94.9	98.4	95.1	99.5	94.4	100	99	92.5	94.8	92.9	94.5
Trucks	0	0	2	2	1	42	1	44	1	2	0	3	3	44	5	52
% Trucks	0	0	9.5	3.7	5.6	5.1	1.6	4.9	0.5	5.6	0	1	7.5	5.2	7.1	5.5

# Accurate Counts

978-664-2565

File Name : 202700B4

Site Code : 20270004

Start Date : 10/2/2024

Page No : 3

N/S Street : Jasmine Way / Prospect St

E/W Street : Pleasant Street

City/State : Bridgewater, MA

Weather : Clear

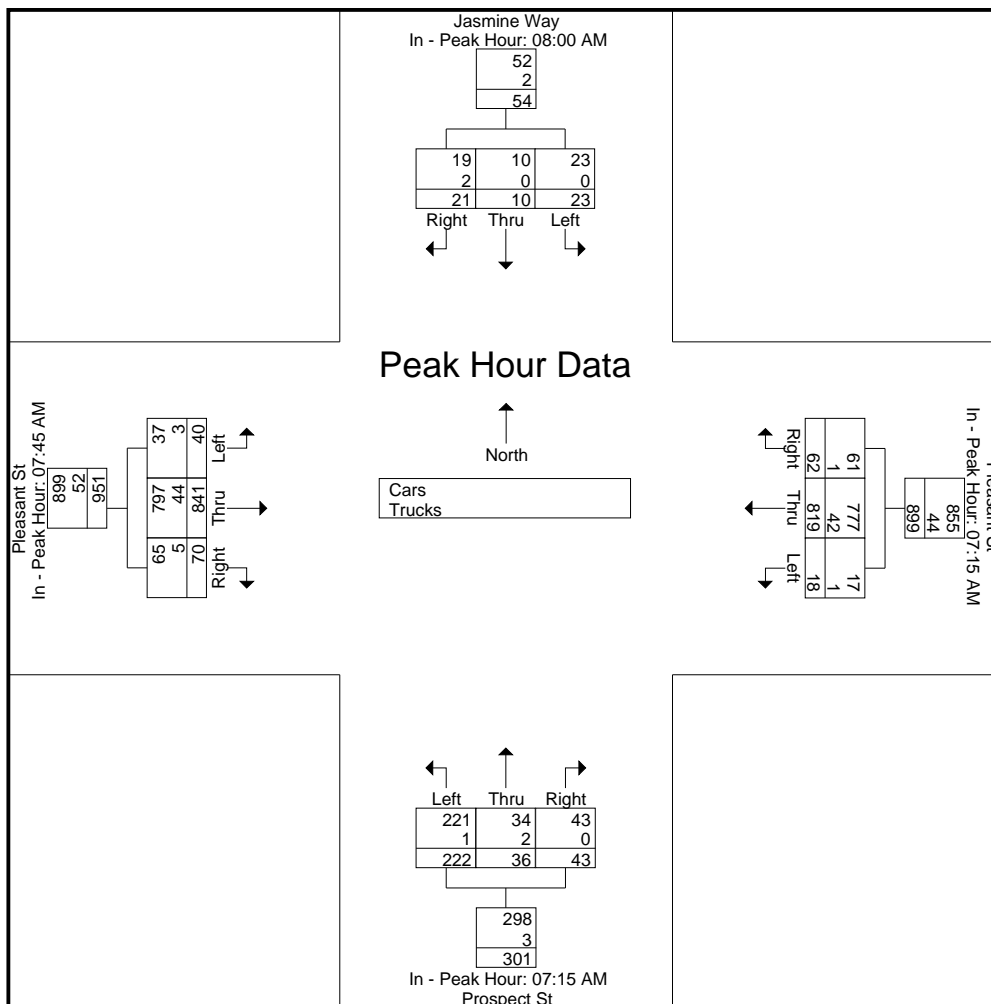

# Accurate Counts

978-664-2565

N/S Street : Jasmine Way / Prospect St

E/W Street : Pleasant Street

City/State : Bridgewater, MA

Weather : Clear

File Name : 202700B4

Site Code : 20270004

Start Date : 10/2/2024

Page No : 4

## Groups Printed- Cars

Start Time	Jasmine Way From North			Pleasant St From East			Prospect St From South			Pleasant St From West			Int. Total
	Left	Thru	Right	Left	Thru	Right	Left	Thru	Right	Left	Thru	Right	
07:00 AM	10	0	2	4	180	15	48	11	13	10	194	15	502
07:15 AM	11	4	3	3	203	16	54	10	10	5	193	21	533
07:30 AM	0	2	2	6	210	16	56	5	9	3	187	21	517
07:45 AM	6	3	1	5	171	17	53	8	11	8	214	14	511
<b>Total</b>	<b>27</b>	<b>9</b>	<b>8</b>	<b>18</b>	<b>764</b>	<b>64</b>	<b>211</b>	<b>34</b>	<b>43</b>	<b>26</b>	<b>788</b>	<b>71</b>	<b>2063</b>
08:00 AM	3	4	6	3	193	12	58	11	13	10	185	16	514
08:15 AM	9	5	4	1	168	19	36	3	8	13	205	20	491
08:30 AM	5	0	4	6	149	15	44	4	7	6	193	15	448
08:45 AM	6	1	5	5	136	18	42	7	9	9	166	16	420
<b>Total</b>	<b>23</b>	<b>10</b>	<b>19</b>	<b>15</b>	<b>646</b>	<b>64</b>	<b>180</b>	<b>25</b>	<b>37</b>	<b>38</b>	<b>749</b>	<b>67</b>	<b>1873</b>
<b>Grand Total</b>	<b>50</b>	<b>19</b>	<b>27</b>	<b>33</b>	<b>1410</b>	<b>128</b>	<b>391</b>	<b>59</b>	<b>80</b>	<b>64</b>	<b>1537</b>	<b>138</b>	<b>3936</b>
Apprch %	52.1	19.8	28.1	2.1	89.8	8.1	73.8	11.1	15.1	3.7	88.4	7.9	
Total %	1.3	0.5	0.7	0.8	35.8	3.3	9.9	1.5	2	1.6	39	3.5	

Start Time	Jasmine Way From North				Pleasant St From East				Prospect St From South				Pleasant St From West				Int. Total
	Left	Thru	Right	App. Total	Left	Thru	Right	App. Total	Left	Thru	Right	App. Total	Left	Thru	Right	App. Total	
<b>Peak Hour Analysis From 07:00 AM to 08:45 AM - Peak 1 of 1</b>																	
<b>Peak Hour for Entire Intersection Begins at 07:15 AM</b>																	
07:15 AM	<b>11</b>	<b>4</b>	<b>3</b>	<b>18</b>	3	203	16	222	54	10	10	74	5	193	<b>21</b>	219	<b>533</b>
07:30 AM	0	2	2	4	<b>6</b>	<b>210</b>	16	<b>232</b>	56	5	9	70	3	187	21	211	517
07:45 AM	6	3	1	10	5	171	<b>17</b>	193	53	8	11	72	8	<b>214</b>	14	<b>236</b>	511
08:00 AM	3	4	<b>6</b>	13	3	193	12	208	<b>58</b>	<b>11</b>	<b>13</b>	<b>82</b>	<b>10</b>	185	16	211	514
Total Volume	20	13	12	45	17	777	61	855	221	34	43	298	26	779	72	877	2075
% App. Total	44.4	28.9	26.7		2	90.9	7.1		74.2	11.4	14.4		3	88.8	8.2		
PHF	.455	.813	.500	.625	.708	.925	.897	.921	.953	.773	.827	.909	.650	.910	.857	.929	.973

# Accurate Counts

978-664-2565

N/S Street : Jasmine Way / Prospect St  
 E/W Street : Pleasant Street  
 City/State : Bridgewater, MA  
 Weather : Clear

File Name : 202700B4  
 Site Code : 20270004  
 Start Date : 10/2/2024  
 Page No : 5

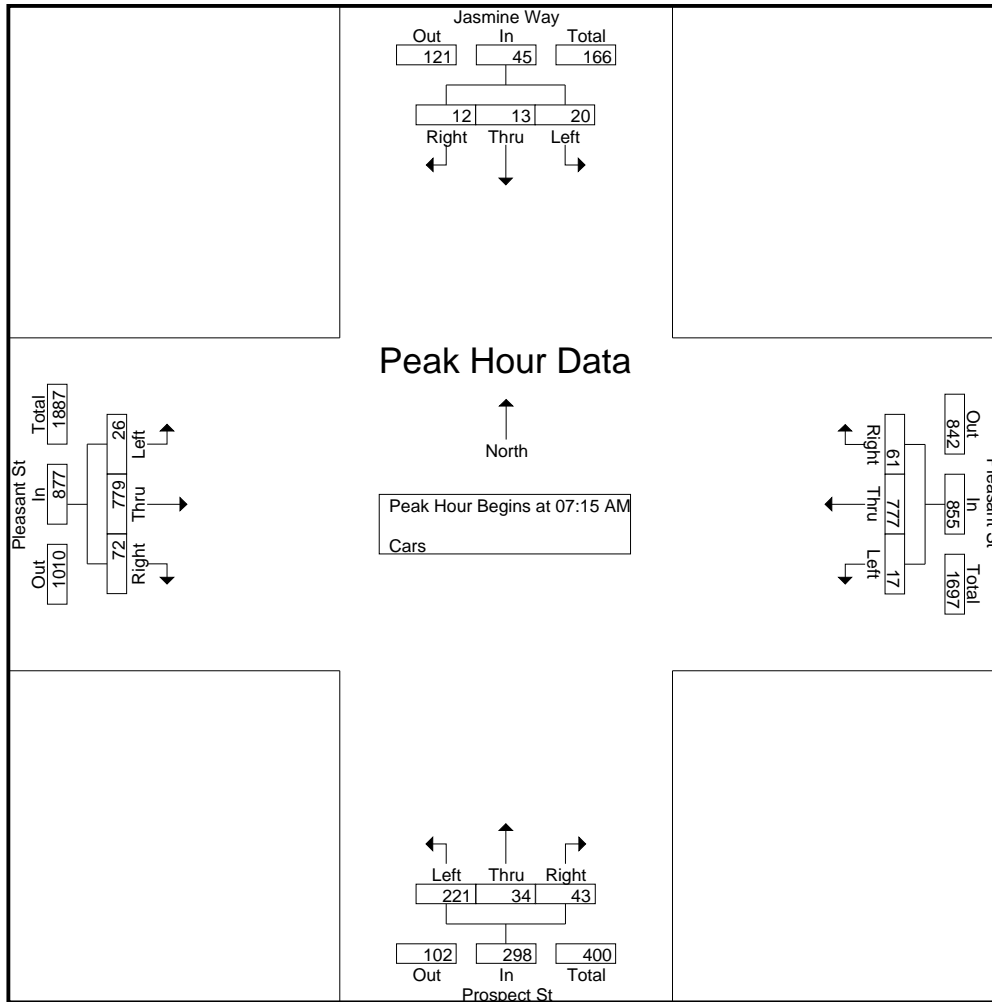

**Peak Hour Analysis From 07:00 AM to 08:45 AM - Peak 1 of 1**

**Peak Hour for Each Approach Begins at:**

	08:00 AM				07:15 AM				07:15 AM				07:45 AM			
+0 mins.	3	4	6	13	3	203	16	222	54	10	10	74	8	<b>214</b>	14	236
+15 mins.	9	5	4	18	6	<b>210</b>	16	<b>232</b>	56	5	9	70	10	185	16	211
+30 mins.	5	0	4	9	5	171	17	193	53	8	11	72	13	205	<b>20</b>	<b>238</b>
+45 mins.	6	1	5	12	3	193	12	208	<b>58</b>	<b>11</b>	<b>13</b>	<b>82</b>	6	193	15	214
Total Volume	23	10	19	52	17	777	61	855	221	34	43	298	37	797	65	899
% App. Total	44.2	19.2	36.5		2	90.9	7.1		74.2	11.4	14.4		4.1	88.7	7.2	
PHF	.639	.500	.792	.722	.708	.925	.897	.921	.953	.773	.827	.909	.712	.931	.813	.944

# Accurate Counts

978-664-2565

File Name : 202700B4

Site Code : 20270004

Start Date : 10/2/2024

Page No : 6

N/S Street : Jasmine Way / Prospect St

E/W Street : Pleasant Street

City/State : Bridgewater, MA

Weather : Clear

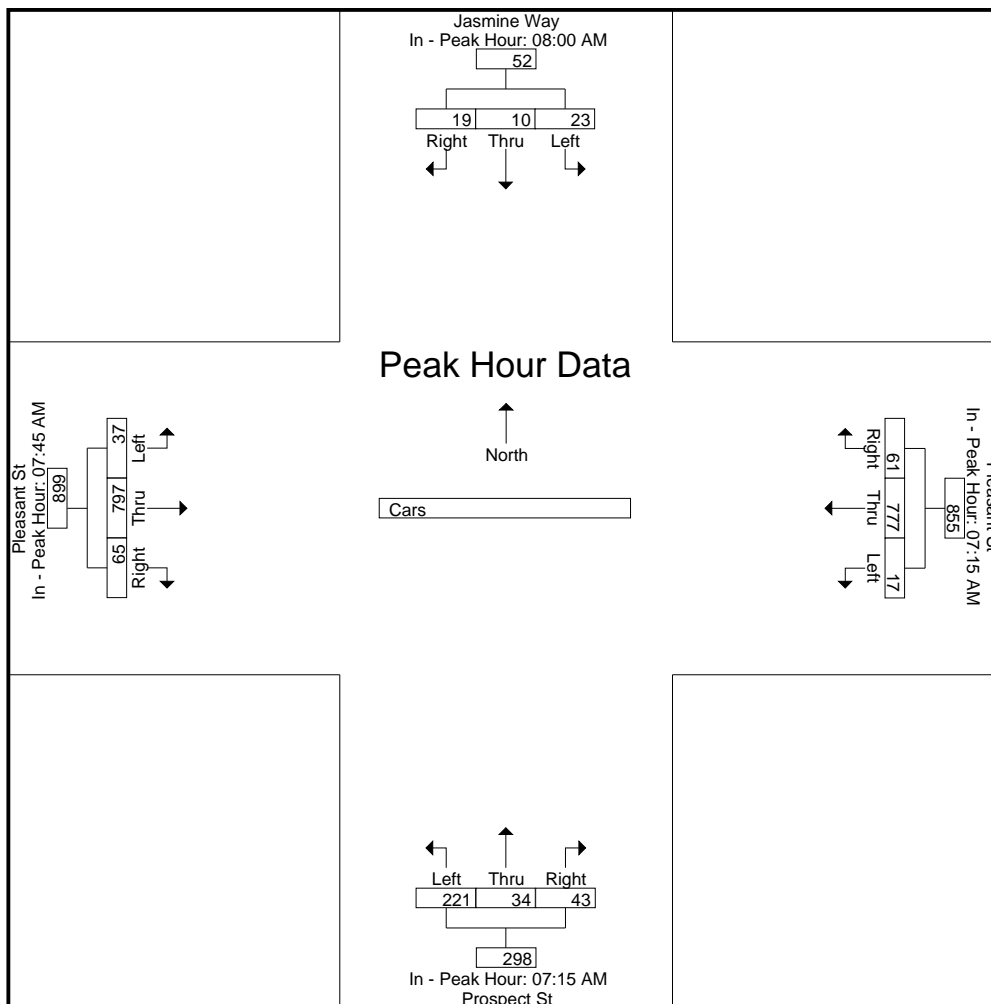

# Accurate Counts

978-664-2565

N/S Street : Jasmine Way / Prospect St  
 E/W Street : Pleasant Street  
 City/State : Bridgewater, MA  
 Weather : Clear

File Name : 202700B4  
 Site Code : 20270004  
 Start Date : 10/2/2024  
 Page No : 7

### Groups Printed- Trucks

Start Time	Jasmine Way From North			Pleasant St From East			Prospect St From South			Pleasant St From West			Int. Total
	Left	Thru	Right	Left	Thru	Right	Left	Thru	Right	Left	Thru	Right	
07:00 AM	0	0	0	0	9	1	3	0	0	0	16	4	33
07:15 AM	1	0	0	0	12	0	0	1	0	2	12	1	29
07:30 AM	1	0	0	1	11	0	0	0	0	0	17	0	30
07:45 AM	0	0	0	0	10	0	1	0	0	2	6	0	19
<b>Total</b>	<b>2</b>	<b>0</b>	<b>0</b>	<b>1</b>	<b>42</b>	<b>1</b>	<b>4</b>	<b>1</b>	<b>0</b>	<b>4</b>	<b>51</b>	<b>5</b>	<b>111</b>
08:00 AM	0	0	0	0	9	1	0	1	0	0	15	1	27
08:15 AM	0	0	1	1	13	0	0	1	0	1	9	0	26
08:30 AM	0	0	1	0	10	0	0	0	0	0	14	4	29
08:45 AM	0	0	0	0	8	0	1	0	0	0	14	0	23
<b>Total</b>	<b>0</b>	<b>0</b>	<b>2</b>	<b>1</b>	<b>40</b>	<b>1</b>	<b>1</b>	<b>2</b>	<b>0</b>	<b>1</b>	<b>52</b>	<b>5</b>	<b>105</b>
<b>Grand Total</b>	<b>2</b>	<b>0</b>	<b>2</b>	<b>2</b>	<b>82</b>	<b>2</b>	<b>5</b>	<b>3</b>	<b>0</b>	<b>5</b>	<b>103</b>	<b>10</b>	<b>216</b>
Apprch %	50	0	50	2.3	95.3	2.3	62.5	37.5	0	4.2	87.3	8.5	
Total %	0.9	0	0.9	0.9	38	0.9	2.3	1.4	0	2.3	47.7	4.6	

Start Time	Jasmine Way From North				Pleasant St From East				Prospect St From South				Pleasant St From West				Int. Total
	Left	Thru	Right	App. Total	Left	Thru	Right	App. Total	Left	Thru	Right	App. Total	Left	Thru	Right	App. Total	
<b>Peak Hour Analysis From 07:00 AM to 08:45 AM - Peak 1 of 1</b>																	
<b>Peak Hour for Entire Intersection Begins at 07:00 AM</b>																	
07:00 AM	0	0	0	0	0	9	1	10	3	0	0	3	0	16	4	20	33
07:15 AM	1	0	0	1	0	12	0	12	0	1	0	1	2	12	1	15	29
07:30 AM	1	0	0	1	1	11	0	12	0	0	0	0	0	17	0	17	30
07:45 AM	0	0	0	0	0	10	0	10	1	0	0	1	2	6	0	8	19
<b>Total Volume</b>	<b>2</b>	<b>0</b>	<b>0</b>	<b>2</b>	<b>1</b>	<b>42</b>	<b>1</b>	<b>44</b>	<b>4</b>	<b>1</b>	<b>0</b>	<b>5</b>	<b>4</b>	<b>51</b>	<b>5</b>	<b>60</b>	<b>111</b>
<b>% App. Total</b>	<b>100</b>	<b>0</b>	<b>0</b>		<b>2.3</b>	<b>95.5</b>	<b>2.3</b>		<b>80</b>	<b>20</b>	<b>0</b>		<b>6.7</b>	<b>85</b>	<b>8.3</b>		
PHF	.500	.000	.000	.500	.250	.875	.250	.917	.333	.250	.000	.417	.500	.750	.313	.750	.841

# Accurate Counts

978-664-2565

N/S Street : Jasmine Way / Prospect St

E/W Street : Pleasant Street

City/State : Bridgewater, MA

Weather : Clear

File Name : 202700B4

Site Code : 20270004

Start Date : 10/2/2024

Page No : 8

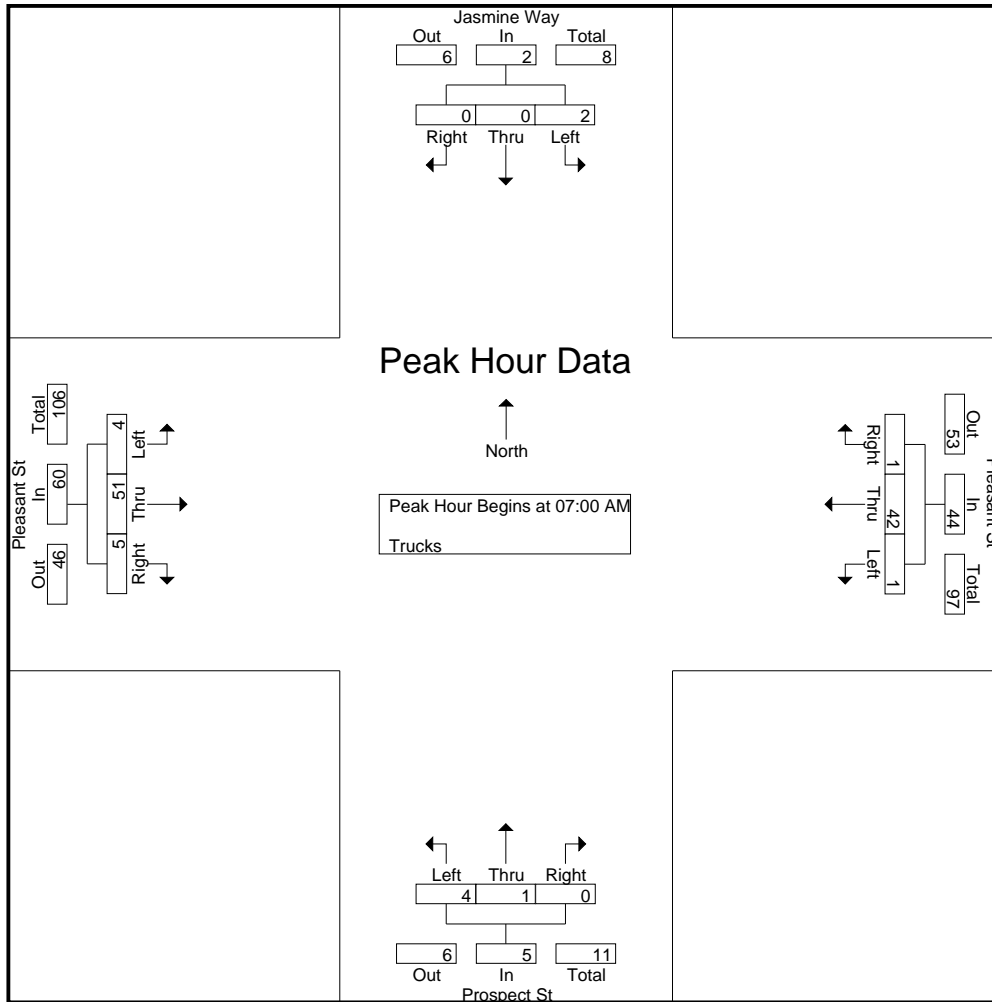

**Peak Hour Analysis From 07:00 AM to 08:45 AM - Peak 1 of 1**

**Peak Hour for Each Approach Begins at:**

	07:00 AM				07:30 AM				07:00 AM				07:00 AM			
+0 mins.	0	0	0	0	1	11	0	12	3	0	0	3	0	16	4	20
+15 mins.	1	0	0	1	0	10	0	10	0	1	0	1	2	12	1	15
+30 mins.	1	0	0	1	0	9	1	10	0	0	0	0	0	17	0	17
+45 mins.	0	0	0	0	1	13	0	14	1	0	0	1	2	6	0	8
Total Volume	2	0	0	2	2	43	1	46	4	1	0	5	4	51	5	60
% App. Total	100	0	0		4.3	93.5	2.2		80	20	0		6.7	85	8.3	
PHF	.500	.000	.000	.500	.500	.827	.250	.821	.333	.250	.000	.417	.500	.750	.313	.750



# Accurate Counts

978-664-2565

File Name : 202700B4

Site Code : 20270004

Start Date : 10/2/2024

Page No : 9

N/S Street : Jasmine Way / Prospect St

E/W Street : Pleasant Street

City/State : Bridgewater, MA

Weather : Clear

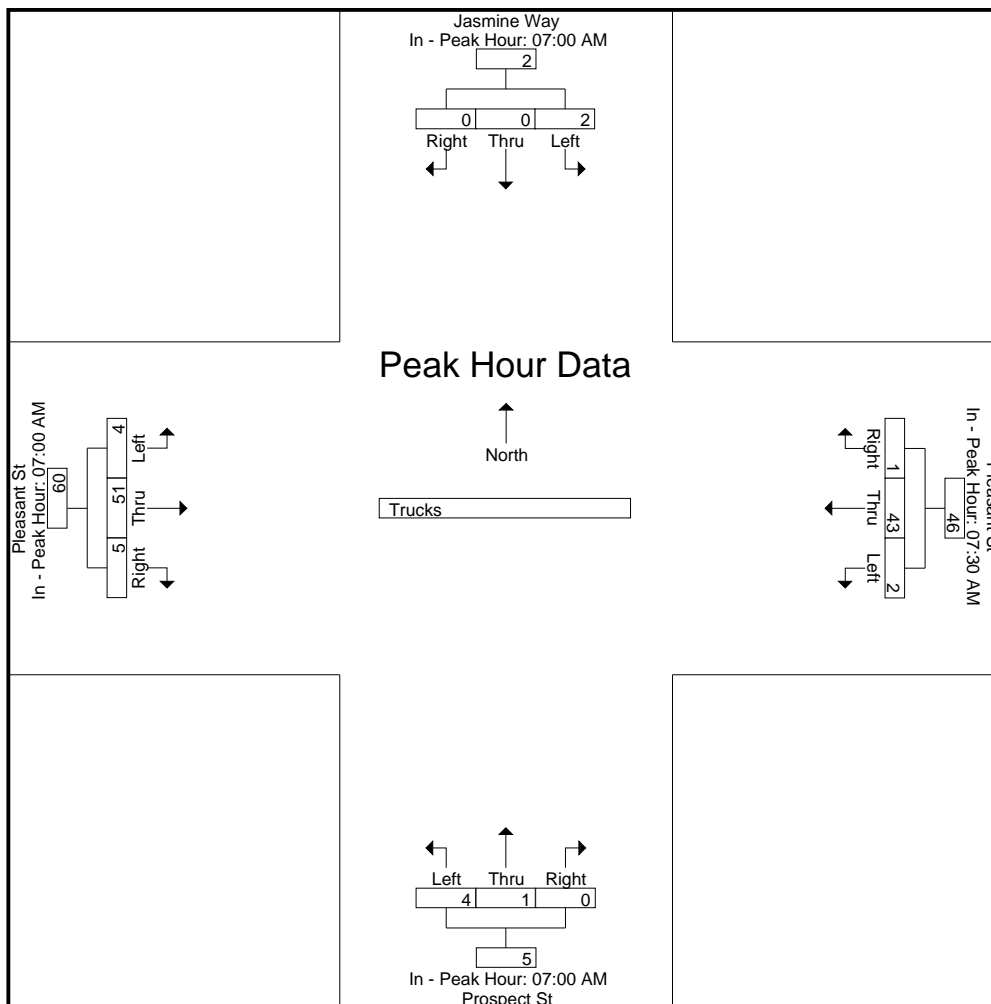

# Accurate Counts

978-664-2565

N/S Street : Jasmine Way / Prospect St

E/W Street : Pleasant Street

City/State : Bridgewater, MA

Weather : Clear

File Name : 202700B4

Site Code : 20270004

Start Date : 10/2/2024

Page No : 10

## Groups Printed- Bikes Peds

Start Time	Jasmine Way From North				Pleasant St From East				Prospect St From South				Pleasant St From West				Exclu. Total	Inclu. Total	Int. Total
	Left	Thru	Right	Peds	Left	Thru	Right	Peds	Left	Thru	Right	Peds	Left	Thru	Right	Peds			
07:00 AM	0	0	0	0	0	0	0	0	0	0	0	1	0	0	0	0	1	0	1
07:15 AM	0	0	0	0	0	0	0	0	0	0	0	0	0	0	0	0	0	0	0
07:30 AM	0	0	0	0	0	0	0	0	0	0	0	0	0	0	0	0	0	0	0
07:45 AM	0	0	0	0	0	0	0	0	0	0	0	1	0	0	0	0	1	0	1
<b>Total</b>	0	0	0	0	0	0	0	0	0	0	0	2	0	0	0	0	2	0	2
08:00 AM	0	0	0	0	0	0	0	0	0	0	0	0	0	0	0	0	0	0	0
08:15 AM	0	0	0	0	0	0	0	0	0	0	0	0	0	0	0	0	0	0	0
08:30 AM	0	0	0	0	0	0	0	0	0	0	0	0	0	0	0	0	0	0	0
08:45 AM	0	0	0	0	0	0	0	0	0	0	0	0	0	0	0	0	0	0	0
<b>Total</b>	0	0	0	0	0	0	0	0	0	0	0	0	0	0	0	0	0	0	0
<b>Grand Total</b>	0	0	0	0	0	0	0	0	0	0	0	2	0	0	0	0	2	0	2
Apprch %	0	0	0		0	0	0		0	0	0		0	0	0				
Total %																	100	0	

Start Time	Jasmine Way From North				Pleasant St From East				Prospect St From South				Pleasant St From West				Int. Total	
	Left	Thru	Right	App. Total	Left	Thru	Right	App. Total	Left	Thru	Right	App. Total	Left	Thru	Right	App. Total		
<b>Peak Hour Analysis From 07:00 AM to 08:45 AM - Peak 1 of 1</b>																		
<b>Peak Hour for Entire Intersection Begins at 07:00 AM</b>																		
07:00 AM	0	0	0	0	0	0	0	0	0	0	0	0	0	0	0	0	0	0
07:15 AM	0	0	0	0	0	0	0	0	0	0	0	0	0	0	0	0	0	0
07:30 AM	0	0	0	0	0	0	0	0	0	0	0	0	0	0	0	0	0	0
07:45 AM	0	0	0	0	0	0	0	0	0	0	0	0	0	0	0	0	0	0
<b>Total Volume</b>	0	0	0	0	0	0	0	0	0	0	0	0	0	0	0	0	0	0
<b>% App. Total</b>	0	0	0		0	0	0		0	0	0		0	0	0			
PHF	.000	.000	.000	.000	.000	.000	.000	.000	.000	.000	.000	.000	.000	.000	.000	.000	.000	.000

# Accurate Counts

978-664-2565

N/S Street : Jasmine Way / Prospect St

E/W Street : Pleasant Street

City/State : Bridgewater, MA

Weather : Clear

File Name : 202700B4

Site Code : 20270004

Start Date : 10/2/2024

Page No : 11

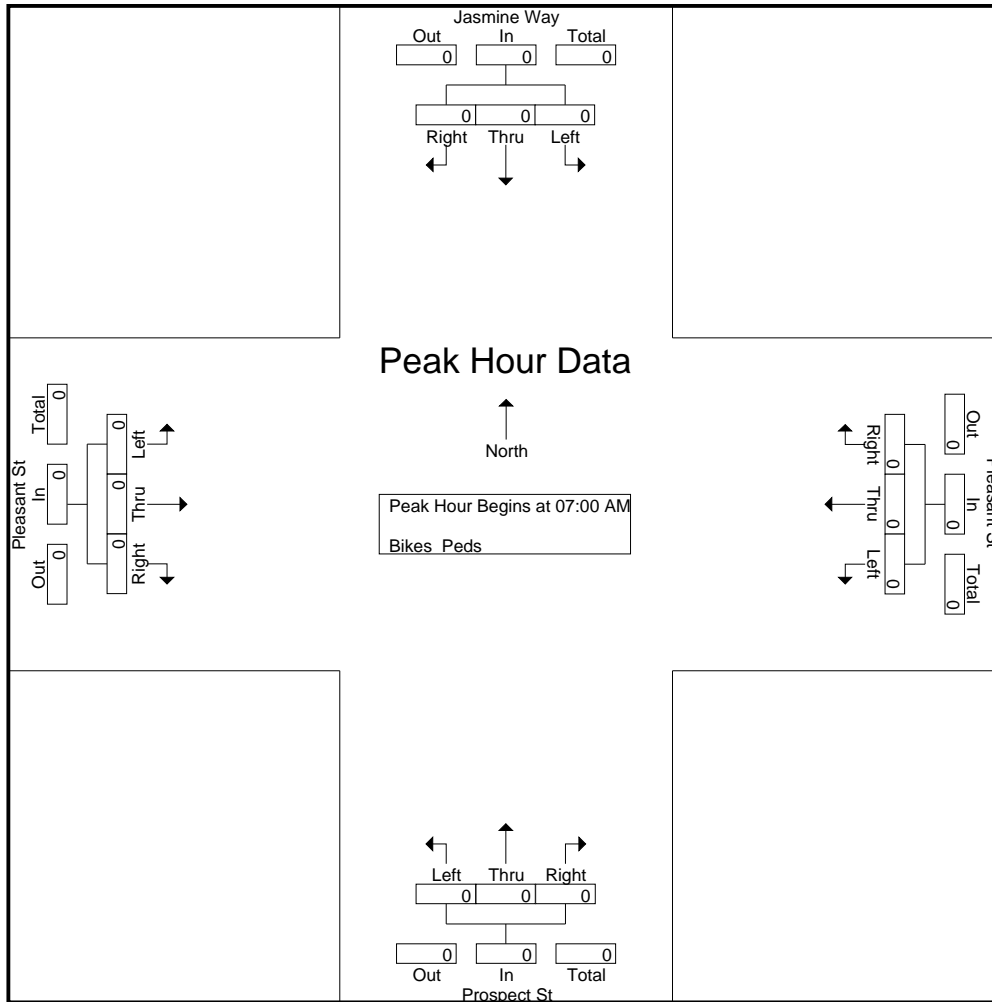

**Peak Hour Analysis From 07:00 AM to 08:45 AM - Peak 1 of 1**

**Peak Hour for Each Approach Begins at:**

	07:00 AM				07:00 AM				07:00 AM				07:00 AM			
+0 mins.	0	0	0	0	0	0	0	0	0	0	0	0	0	0	0	0
+15 mins.	0	0	0	0	0	0	0	0	0	0	0	0	0	0	0	0
+30 mins.	0	0	0	0	0	0	0	0	0	0	0	0	0	0	0	0
+45 mins.	0	0	0	0	0	0	0	0	0	0	0	0	0	0	0	0
Total Volume	0	0	0	0	0	0	0	0	0	0	0	0	0	0	0	0
% App. Total	0	0	0	0	0	0	0	0	0	0	0	0	0	0	0	0
PHF	.000	.000	.000	.000	.000	.000	.000	.000	.000	.000	.000	.000	.000	.000	.000	.000

# Accurate Counts

978-664-2565

File Name : 202700B4

Site Code : 20270004

Start Date : 10/2/2024

Page No : 12

N/S Street : Jasmine Way / Prospect St

E/W Street : Pleasant Street

City/State : Bridgewater, MA

Weather : Clear

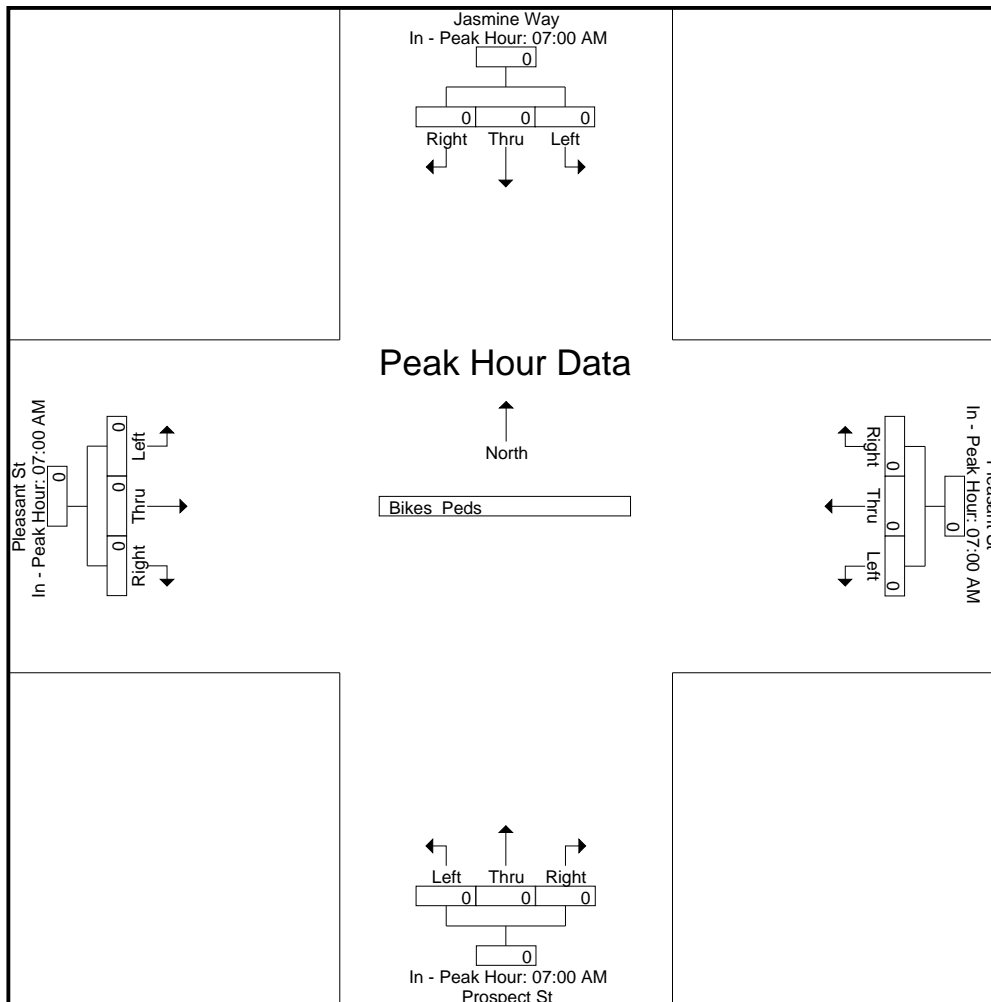

# Accurate Counts

978-664-2565

N/S Street : Jasmine Way / Prospect St  
 E/W Street : Pleasant Street  
 City/State : Bridgewater, MA  
 Weather : Clear

File Name : 202700B4  
 Site Code : 20270004  
 Start Date : 10/2/2024  
 Page No : 1

### Groups Printed- Cars - Trucks

Start Time	Jasmine Way From North			Pleasant St From East			Prospect St From South			Pleasant St From West			Int. Total
	Left	Thru	Right	Left	Thru	Right	Left	Thru	Right	Left	Thru	Right	
04:00 PM	20	9	2	6	173	15	30	8	2	9	196	39	509
04:15 PM	13	4	4	8	182	13	29	7	2	14	201	37	514
04:30 PM	14	9	1	6	187	10	30	5	5	7	181	39	494
04:45 PM	8	6	3	3	152	12	34	3	2	11	182	45	461
<b>Total</b>	<b>55</b>	<b>28</b>	<b>10</b>	<b>23</b>	<b>694</b>	<b>50</b>	<b>123</b>	<b>23</b>	<b>11</b>	<b>41</b>	<b>760</b>	<b>160</b>	<b>1978</b>
05:00 PM	7	7	5	7	170	16	23	4	7	6	198	39	489
05:15 PM	6	7	5	5	168	16	34	4	2	6	207	40	500
05:30 PM	11	4	2	10	168	12	20	0	2	13	204	41	487
05:45 PM	8	11	2	6	134	14	24	7	4	11	208	47	476
<b>Total</b>	<b>32</b>	<b>29</b>	<b>14</b>	<b>28</b>	<b>640</b>	<b>58</b>	<b>101</b>	<b>15</b>	<b>15</b>	<b>36</b>	<b>817</b>	<b>167</b>	<b>1952</b>
<b>Grand Total</b>	<b>87</b>	<b>57</b>	<b>24</b>	<b>51</b>	<b>1334</b>	<b>108</b>	<b>224</b>	<b>38</b>	<b>26</b>	<b>77</b>	<b>1577</b>	<b>327</b>	<b>3930</b>
Apprch %	51.8	33.9	14.3	3.4	89.4	7.2	77.8	13.2	9	3.9	79.6	16.5	
Total %	2.2	1.5	0.6	1.3	33.9	2.7	5.7	1	0.7	2	40.1	8.3	
Cars	86	57	24	51	1305	106	220	38	26	76	1532	323	3844
% Cars	98.9	100	100	100	97.8	98.1	98.2	100	100	98.7	97.1	98.8	97.8
Trucks	1	0	0	0	29	2	4	0	0	1	45	4	86
% Trucks	1.1	0	0	0	2.2	1.9	1.8	0	0	1.3	2.9	1.2	2.2

Start Time	Jasmine Way From North				Pleasant St From East				Prospect St From South				Pleasant St From West				Int. Total
	Left	Thru	Right	App. Total	Left	Thru	Right	App. Total	Left	Thru	Right	App. Total	Left	Thru	Right	App. Total	
Peak Hour Analysis From 04:00 PM to 05:45 PM - Peak 1 of 1																	
Peak Hour for Entire Intersection Begins at 04:00 PM																	
04:00 PM	<b>20</b>	<b>9</b>	<b>2</b>	<b>31</b>	6	173	<b>15</b>	194	30	<b>8</b>	2	<b>40</b>	9	196	39	244	509
04:15 PM	13	4	<b>4</b>	21	<b>8</b>	182	13	<b>203</b>	29	7	2	38	<b>14</b>	<b>201</b>	37	<b>252</b>	<b>514</b>
04:30 PM	14	9	1	24	6	<b>187</b>	10	203	30	5	<b>5</b>	40	7	181	39	227	494
04:45 PM	8	6	3	17	3	152	12	167	<b>34</b>	3	2	39	11	182	<b>45</b>	238	461
<b>Total Volume</b>	<b>55</b>	<b>28</b>	<b>10</b>	<b>93</b>	<b>23</b>	<b>694</b>	<b>50</b>	<b>767</b>	<b>123</b>	<b>23</b>	<b>11</b>	<b>157</b>	<b>41</b>	<b>760</b>	<b>160</b>	<b>961</b>	<b>1978</b>
% App. Total	59.1	30.1	10.8		3	90.5	6.5		78.3	14.6	7		4.3	79.1	16.6		
PHF	.688	.778	.625	.750	.719	.928	.833	.945	.904	.719	.550	.981	.732	.945	.889	.953	.962
Cars	54	28	10	92	23	673	49	745	121	23	11	155	40	730	159	929	1921
% Cars	98.2	100	100	98.9	100	97.0	98.0	97.1	98.4	100	100	98.7	97.6	96.1	99.4	96.7	97.1
Trucks	1	0	0	1	0	21	1	22	2	0	0	2	1	30	1	32	57
% Trucks	1.8	0	0	1.1	0	3.0	2.0	2.9	1.6	0	0	1.3	2.4	3.9	0.6	3.3	2.9

# Accurate Counts

978-664-2565

N/S Street : Jasmine Way / Prospect St

E/W Street : Pleasant Street

City/State : Bridgewater, MA

Weather : Clear

File Name : 202700B4

Site Code : 20270004

Start Date : 10/2/2024

Page No : 2

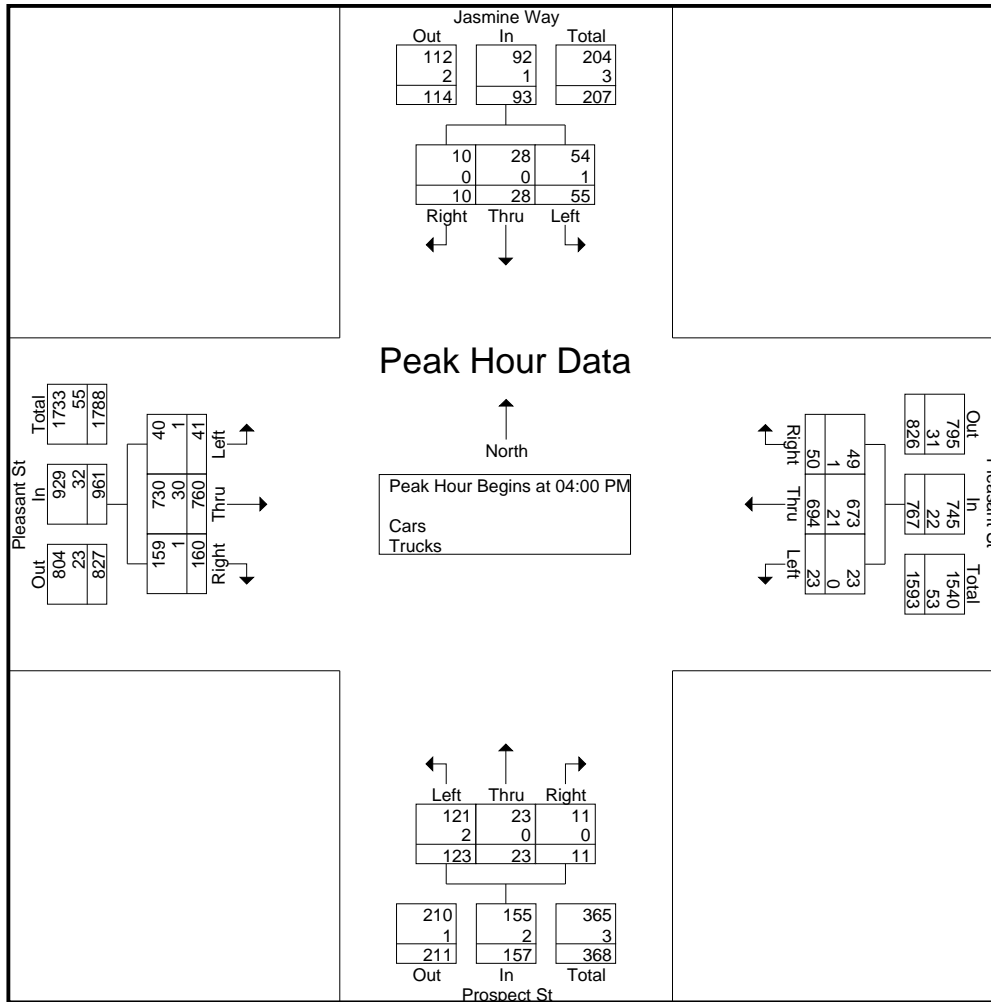

Peak Hour Analysis From 04:00 PM to 05:45 PM - Peak 1 of 1

Peak Hour for Each Approach Begins at:

	04:00 PM				04:00 PM				04:00 PM				05:00 PM			
+0 mins.	20	9	2	31	6	173	15	194	30	8	2	40	6	198	39	243
+15 mins.	13	4	4	21	8	182	13	203	29	7	2	38	6	207	40	253
+30 mins.	14	9	1	24	6	187	10	203	30	5	5	40	13	204	41	258
+45 mins.	8	6	3	17	3	152	12	167	34	3	2	39	11	208	47	266
Total Volume	55	28	10	93	23	694	50	767	123	23	11	157	36	817	167	1020
% App. Total	59.1	30.1	10.8		3	90.5	6.5		78.3	14.6	7		3.5	80.1	16.4	
PHF	.688	.778	.625	.750	.719	.928	.833	.945	.904	.719	.550	.981	.692	.982	.888	.959
Cars	54	28	10	92	23	673	49	745	121	23	11	155	36	802	164	1002
% Cars	98.2	100	100	98.9	100	97	98	97.1	98.4	100	100	98.7	100	98.2	98.2	98.2
Trucks	1	0	0	1	0	21	1	22	2	0	0	2	0	15	3	18
% Trucks	1.8	0	0	1.1	0	3	2	2.9	1.6	0	0	1.3	0	1.8	1.8	1.8

# Accurate Counts

978-664-2565

N/S Street : Jasmine Way / Prospect St  
 E/W Street : Pleasant Street  
 City/State : Bridgewater, MA  
 Weather : Clear

File Name : 202700B4  
 Site Code : 20270004  
 Start Date : 10/2/2024  
 Page No : 3

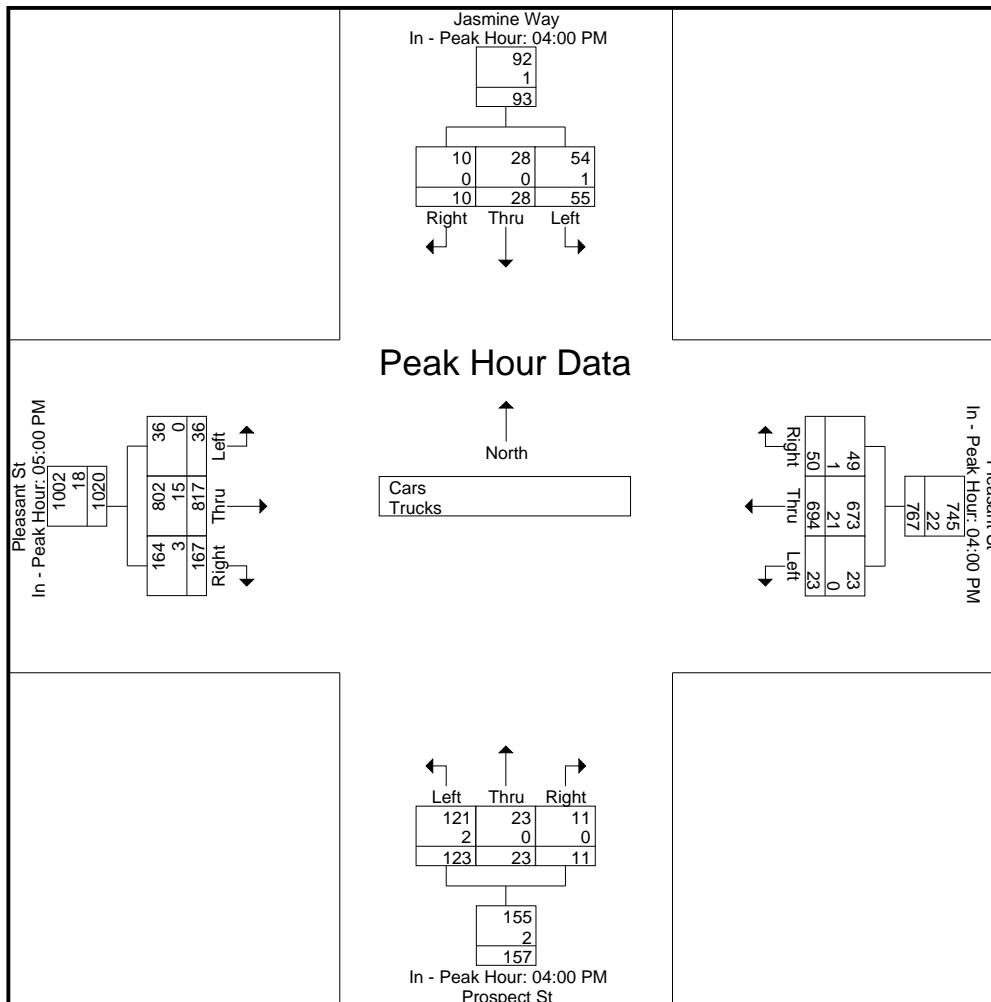

# Accurate Counts

978-664-2565

N/S Street : Jasmine Way / Prospect St  
 E/W Street : Pleasant Street  
 City/State : Bridgewater, MA  
 Weather : Clear

File Name : 202700B4  
 Site Code : 20270004  
 Start Date : 10/2/2024  
 Page No : 4

## Groups Printed- Cars

Start Time	Jasmine Way From North			Pleasant St From East			Prospect St From South			Pleasant St From West			Int. Total
	Left	Thru	Right	Left	Thru	Right	Left	Thru	Right	Left	Thru	Right	
04:00 PM	20	9	2	6	166	14	29	8	2	9	189	38	492
04:15 PM	12	4	4	8	175	13	28	7	2	13	190	37	493
04:30 PM	14	9	1	6	182	10	30	5	5	7	174	39	482
04:45 PM	8	6	3	3	150	12	34	3	2	11	177	45	454
<b>Total</b>	<b>54</b>	<b>28</b>	<b>10</b>	<b>23</b>	<b>673</b>	<b>49</b>	<b>121</b>	<b>23</b>	<b>11</b>	<b>40</b>	<b>730</b>	<b>159</b>	<b>1921</b>
05:00 PM	7	7	5	7	165	16	22	4	7	6	195	37	478
05:15 PM	6	7	5	5	167	15	33	4	2	6	202	40	492
05:30 PM	11	4	2	10	167	12	20	0	2	13	202	40	483
05:45 PM	8	11	2	6	133	14	24	7	4	11	203	47	470
<b>Total</b>	<b>32</b>	<b>29</b>	<b>14</b>	<b>28</b>	<b>632</b>	<b>57</b>	<b>99</b>	<b>15</b>	<b>15</b>	<b>36</b>	<b>802</b>	<b>164</b>	<b>1923</b>
<b>Grand Total</b>	<b>86</b>	<b>57</b>	<b>24</b>	<b>51</b>	<b>1305</b>	<b>106</b>	<b>220</b>	<b>38</b>	<b>26</b>	<b>76</b>	<b>1532</b>	<b>323</b>	<b>3844</b>
Apprch %	51.5	34.1	14.4	3.5	89.3	7.3	77.5	13.4	9.2	3.9	79.3	16.7	
Total %	2.2	1.5	0.6	1.3	33.9	2.8	5.7	1	0.7	2	39.9	8.4	

Start Time	Jasmine Way From North				Pleasant St From East				Prospect St From South				Pleasant St From West				Int. Total
	Left	Thru	Right	App. Total	Left	Thru	Right	App. Total	Left	Thru	Right	App. Total	Left	Thru	Right	App. Total	
<b>Peak Hour Analysis From 04:00 PM to 05:45 PM - Peak 1 of 1</b>																	
<b>Peak Hour for Entire Intersection Begins at 05:00 PM</b>																	
05:00 PM	7	7	5	19	7	165	<b>16</b>	188	22	4	<b>7</b>	33	6	195	37	238	478
05:15 PM	6	7	5	18	5	<b>167</b>	15	187	<b>33</b>	4	2	<b>39</b>	6	202	40	248	<b>492</b>
05:30 PM	<b>11</b>	4	2	17	<b>10</b>	167	12	<b>189</b>	20	0	2	22	<b>13</b>	202	40	255	483
05:45 PM	8	<b>11</b>	2	<b>21</b>	6	133	14	153	24	<b>7</b>	4	35	11	<b>203</b>	<b>47</b>	<b>261</b>	470
<b>Total Volume</b>	32	29	14	75	28	632	57	717	99	15	15	129	36	802	164	1002	1923
<b>% App. Total</b>	42.7	38.7	18.7		3.9	88.1	7.9		76.7	11.6	11.6		3.6	80	16.4		
PHF	.727	.659	.700	.893	.700	.946	.891	.948	.750	.536	.536	.827	.692	.988	.872	.960	.977



# Accurate Counts

978-664-2565

N/S Street : Jasmine Way / Prospect St

E/W Street : Pleasant Street

City/State : Bridgewater, MA

Weather : Clear

File Name : 202700B4

Site Code : 20270004

Start Date : 10/2/2024

Page No : 5

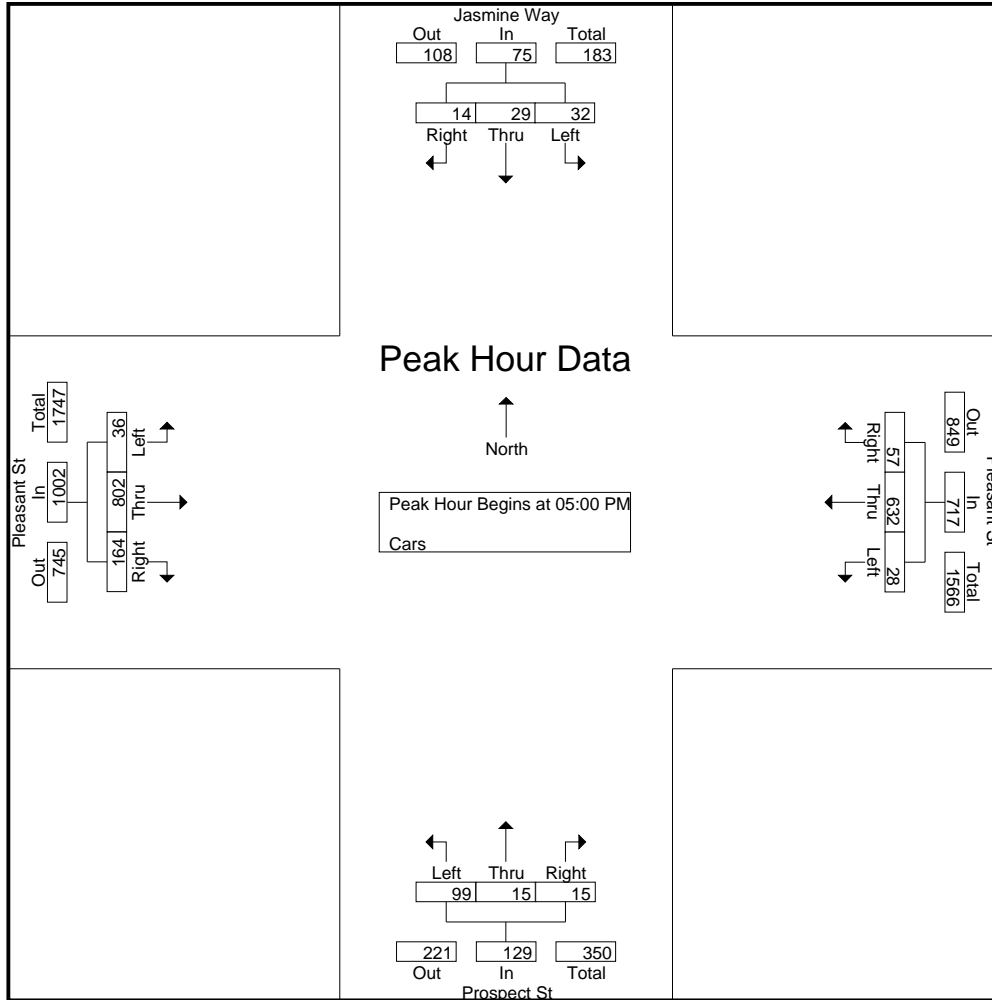

**Peak Hour Analysis From 04:00 PM to 05:45 PM - Peak 1 of 1**

**Peak Hour for Each Approach Begins at:**

	04:00 PM				04:15 PM				04:00 PM				05:00 PM			
+0 mins.	<b>20</b>	<b>9</b>	<b>2</b>	<b>31</b>	<b>8</b>	175	13	196	29	<b>8</b>	2	39	6	195	37	238
+15 mins.	12	4	<b>4</b>	20	6	<b>182</b>	10	<b>198</b>	28	7	2	37	6	202	40	248
+30 mins.	14	9	1	24	3	150	12	165	30	5	<b>5</b>	<b>40</b>	<b>13</b>	202	40	255
+45 mins.	8	6	3	17	7	165	<b>16</b>	188	<b>34</b>	3	2	39	11	<b>203</b>	<b>47</b>	<b>261</b>
Total Volume	54	28	10	92	24	672	51	747	121	23	11	155	36	802	164	1002
% App. Total	58.7	30.4	10.9		3.2	90	6.8		78.1	14.8	7.1		3.6	80	16.4	
PHF	.675	.778	.625	.742	.750	.923	.797	.943	.890	.719	.550	.969	.692	.988	.872	.960

# Accurate Counts

978-664-2565

N/S Street : Jasmine Way / Prospect St

E/W Street : Pleasant Street

City/State : Bridgewater, MA

Weather : Clear

File Name : 202700B4

Site Code : 20270004

Start Date : 10/2/2024

Page No : 6

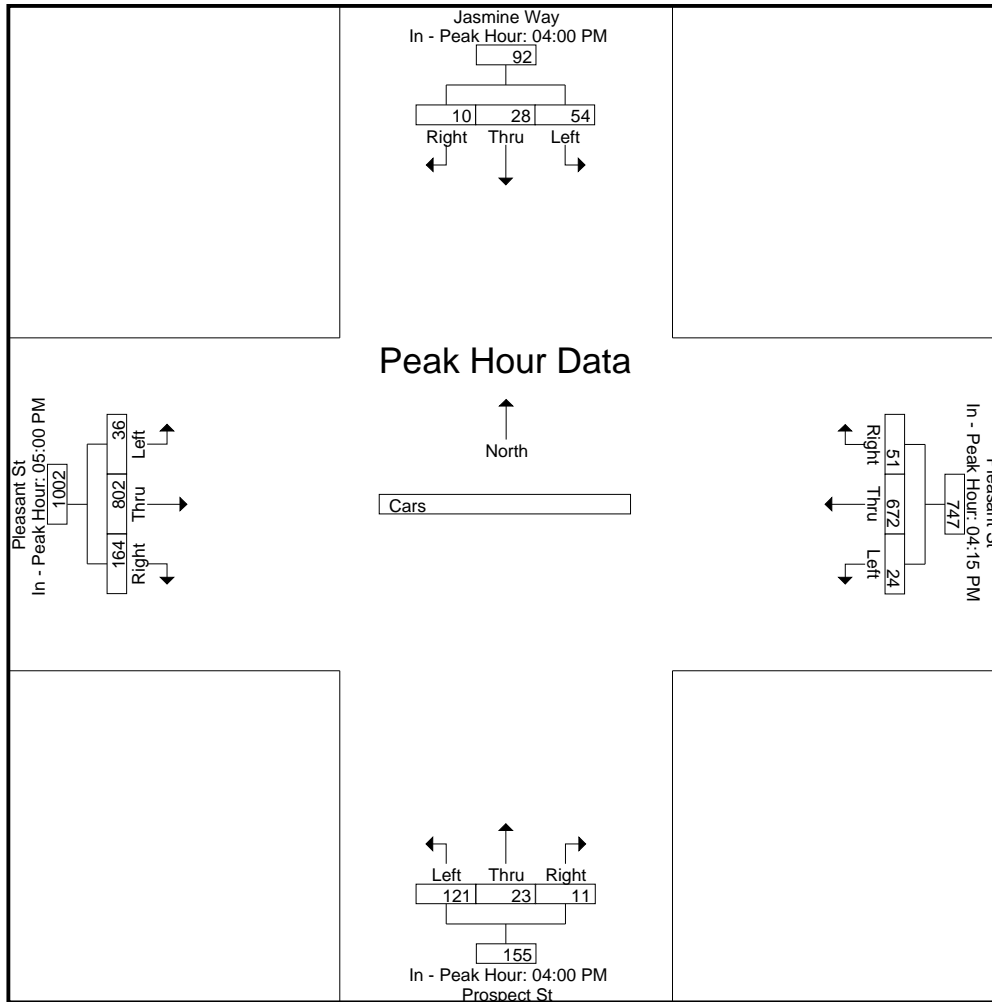

# Accurate Counts

978-664-2565

N/S Street : Jasmine Way / Prospect St

E/W Street : Pleasant Street

City/State : Bridgewater, MA

Weather : Clear

File Name : 202700B4

Site Code : 20270004

Start Date : 10/2/2024

Page No : 7

### Groups Printed- Trucks

Start Time	Jasmine Way From North			Pleasant St From East			Prospect St From South			Pleasant St From West			Int. Total
	Left	Thru	Right	Left	Thru	Right	Left	Thru	Right	Left	Thru	Right	
04:00 PM	0	0	0	0	7	1	1	0	0	0	7	1	17
04:15 PM	1	0	0	0	7	0	1	0	0	1	11	0	21
04:30 PM	0	0	0	0	5	0	0	0	0	0	7	0	12
04:45 PM	0	0	0	0	2	0	0	0	0	0	5	0	7
<b>Total</b>	<b>1</b>	<b>0</b>	<b>0</b>	<b>0</b>	<b>21</b>	<b>1</b>	<b>2</b>	<b>0</b>	<b>0</b>	<b>1</b>	<b>30</b>	<b>1</b>	<b>57</b>
05:00 PM	0	0	0	0	5	0	1	0	0	0	3	2	11
05:15 PM	0	0	0	0	1	1	1	0	0	0	5	0	8
05:30 PM	0	0	0	0	1	0	0	0	0	0	2	1	4
05:45 PM	0	0	0	0	1	0	0	0	0	0	5	0	6
<b>Total</b>	<b>0</b>	<b>0</b>	<b>0</b>	<b>0</b>	<b>8</b>	<b>1</b>	<b>2</b>	<b>0</b>	<b>0</b>	<b>0</b>	<b>15</b>	<b>3</b>	<b>29</b>
<b>Grand Total</b>	<b>1</b>	<b>0</b>	<b>0</b>	<b>0</b>	<b>29</b>	<b>2</b>	<b>4</b>	<b>0</b>	<b>0</b>	<b>1</b>	<b>45</b>	<b>4</b>	<b>86</b>
Apprch %	100	0	0	0	93.5	6.5	100	0	0	2	90	8	
Total %	1.2	0	0	0	33.7	2.3	4.7	0	0	1.2	52.3	4.7	

Start Time	Jasmine Way From North				Pleasant St From East				Prospect St From South				Pleasant St From West				Int. Total
	Left	Thru	Right	App. Total	Left	Thru	Right	App. Total	Left	Thru	Right	App. Total	Left	Thru	Right	App. Total	
<b>Peak Hour Analysis From 04:00 PM to 05:45 PM - Peak 1 of 1</b>																	
<b>Peak Hour for Entire Intersection Begins at 04:00 PM</b>																	
04:00 PM	0	0	0	0	0	7	1	8	1	0	0	1	0	7	1	8	17
04:15 PM	1	0	0	1	0	7	0	7	1	0	0	1	1	11	0	12	21
04:30 PM	0	0	0	0	0	5	0	5	0	0	0	0	0	7	0	7	12
04:45 PM	0	0	0	0	0	2	0	2	0	0	0	0	0	5	0	5	7
<b>Total Volume</b>	<b>1</b>	<b>0</b>	<b>0</b>	<b>1</b>	<b>0</b>	<b>21</b>	<b>1</b>	<b>22</b>	<b>2</b>	<b>0</b>	<b>0</b>	<b>2</b>	<b>1</b>	<b>30</b>	<b>1</b>	<b>32</b>	<b>57</b>
<b>% App. Total</b>	<b>100</b>	<b>0</b>	<b>0</b>		<b>0</b>	<b>95.5</b>	<b>4.5</b>		<b>100</b>	<b>0</b>	<b>0</b>		<b>3.1</b>	<b>93.8</b>	<b>3.1</b>		
PHF	.250	.000	.000	.250	.000	.750	.250	.688	.500	.000	.000	.500	.250	.682	.250	.667	.679

# Accurate Counts

978-664-2565

N/S Street : Jasmine Way / Prospect St

E/W Street : Pleasant Street

City/State : Bridgewater, MA

Weather : Clear

File Name : 202700B4

Site Code : 20270004

Start Date : 10/2/2024

Page No : 8

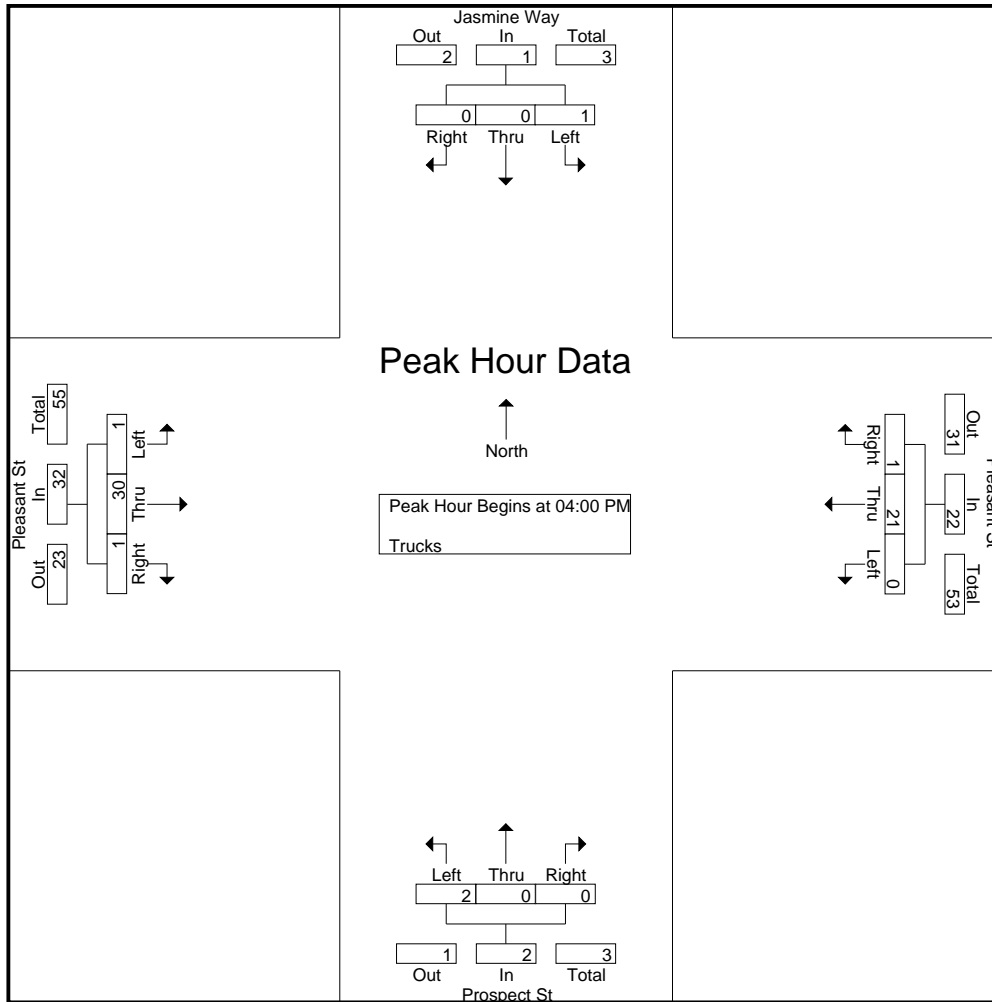

**Peak Hour Analysis From 04:00 PM to 05:45 PM - Peak 1 of 1**

**Peak Hour for Each Approach Begins at:**

	04:00 PM				04:00 PM				04:00 PM				04:00 PM			
+0 mins.	0	0	0	0	0	7	1	8	1	0	0	1	0	7	1	8
+15 mins.	1	0	0	1	0	7	0	7	1	0	0	1	1	11	0	12
+30 mins.	0	0	0	0	0	5	0	5	0	0	0	0	0	7	0	7
+45 mins.	0	0	0	0	0	2	0	2	0	0	0	0	0	5	0	5
<b>Total Volume</b>	1	0	0	1	0	21	1	22	2	0	0	2	1	30	1	32
<b>% App. Total</b>	100	0	0		0	95.5	4.5		100	0	0		3.1	93.8	3.1	
<b>PHF</b>	.250	.000	.000	.250	.000	.750	.250	.688	.500	.000	.000	.500	.250	.682	.250	.667

# Accurate Counts

978-664-2565

N/S Street : Jasmine Way / Prospect St

E/W Street : Pleasant Street

City/State : Bridgewater, MA

Weather : Clear

File Name : 202700B4

Site Code : 20270004

Start Date : 10/2/2024

Page No : 9

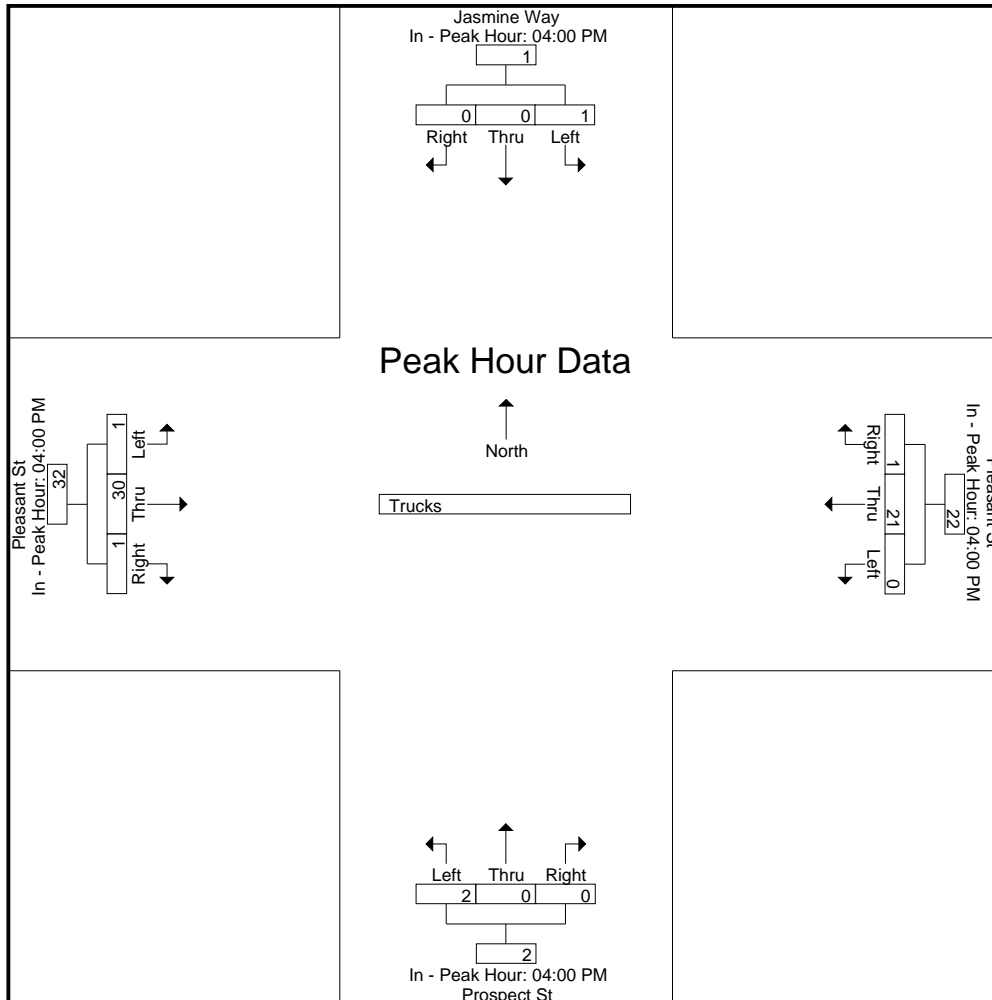

# Accurate Counts

978-664-2565

N/S Street : Jasmine Way / Prospect St

E/W Street : Pleasant Street

City/State : Bridgewater, MA

Weather : Clear

File Name : 202700B4

Site Code : 20270004

Start Date : 10/2/2024

Page No : 10

## Groups Printed- Bikes Peds

Start Time	Jasmine Way From North				Pleasant St From East				Prospect St From South				Pleasant St From West				Exclu. Total	Inclu. Total	Int. Total
	Left	Thru	Right	Peds	Left	Thru	Right	Peds	Left	Thru	Right	Peds	Left	Thru	Right	Peds			
04:00 PM	0	0	0	0	0	0	0	0	0	0	0	0	0	0	0	0	0	0	0
04:15 PM	0	0	0	0	0	0	0	0	0	0	0	0	0	0	0	0	0	0	0
04:30 PM	0	0	0	0	0	0	0	0	0	0	0	0	0	0	0	0	0	0	0
04:45 PM	0	0	0	0	0	0	0	0	0	0	0	0	0	0	0	1	1	0	1
<b>Total</b>	0	0	0	0	0	0	0	0	0	0	0	0	0	0	0	1	1	0	1
05:00 PM	0	0	0	0	0	0	0	0	0	0	0	0	0	0	0	1	1	0	1
05:15 PM	0	0	0	3	0	0	0	0	0	0	0	0	0	0	0	0	3	0	3
05:30 PM	0	0	0	0	0	0	0	0	0	0	0	0	0	0	0	0	0	0	0
05:45 PM	0	0	0	0	0	0	0	0	0	0	0	0	0	0	0	0	0	0	0
<b>Total</b>	0	0	0	3	0	0	0	0	0	0	0	0	0	0	0	1	4	0	4
<b>Grand Total</b>	0	0	0	3	0	0	0	0	0	0	0	0	0	0	0	2	5	0	5
Apprch %	0	0	0		0	0	0		0	0	0		0	0	0				
Total %																	100	0	

Start Time	Jasmine Way From North				Pleasant St From East				Prospect St From South				Pleasant St From West				Int. Total	
	Left	Thru	Right	App. Total	Left	Thru	Right	App. Total	Left	Thru	Right	App. Total	Left	Thru	Right	App. Total		
Peak Hour Analysis From 04:00 PM to 05:45 PM - Peak 1 of 1																		
Peak Hour for Entire Intersection Begins at 04:00 PM																		
04:00 PM	0	0	0	0	0	0	0	0	0	0	0	0	0	0	0	0	0	0
04:15 PM	0	0	0	0	0	0	0	0	0	0	0	0	0	0	0	0	0	0
04:30 PM	0	0	0	0	0	0	0	0	0	0	0	0	0	0	0	0	0	0
04:45 PM	0	0	0	0	0	0	0	0	0	0	0	0	0	0	0	0	0	0
<b>Total Volume</b>	0	0	0	0	0	0	0	0	0	0	0	0	0	0	0	0	0	0
<b>% App. Total</b>	0	0	0		0	0	0		0	0	0		0	0	0			
PHF	.000	.000	.000	.000	.000	.000	.000	.000	.000	.000	.000	.000	.000	.000	.000	.000	.000	.000

# Accurate Counts

978-664-2565

N/S Street : Jasmine Way / Prospect St

E/W Street : Pleasant Street

City/State : Bridgewater, MA

Weather : Clear

File Name : 202700B4

Site Code : 20270004

Start Date : 10/2/2024

Page No : 11

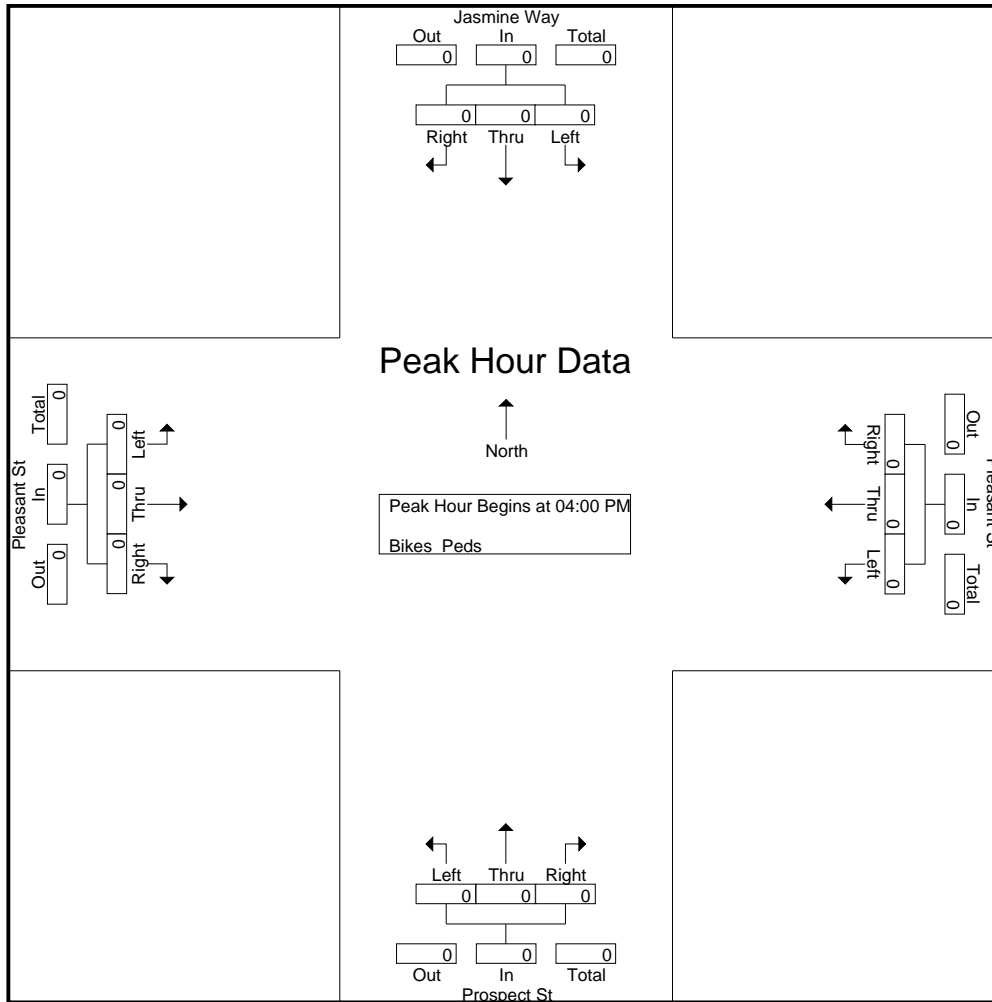

**Peak Hour Analysis From 04:00 PM to 05:45 PM - Peak 1 of 1**

**Peak Hour for Each Approach Begins at:**

	04:00 PM				04:00 PM				04:00 PM				04:00 PM			
+0 mins.	0	0	0	0	0	0	0	0	0	0	0	0	0	0	0	0
+15 mins.	0	0	0	0	0	0	0	0	0	0	0	0	0	0	0	0
+30 mins.	0	0	0	0	0	0	0	0	0	0	0	0	0	0	0	0
+45 mins.	0	0	0	0	0	0	0	0	0	0	0	0	0	0	0	0
Total Volume	0	0	0	0	0	0	0	0	0	0	0	0	0	0	0	0
% App. Total	0	0	0	0	0	0	0	0	0	0	0	0	0	0	0	0
PHF	.000	.000	.000	.000	.000	.000	.000	.000	.000	.000	.000	.000	.000	.000	.000	.000

# Accurate Counts

978-664-2565

N/S Street : Jasmine Way / Prospect St

E/W Street : Pleasant Street

City/State : Bridgewater, MA

Weather : Clear

File Name : 202700B4

Site Code : 20270004

Start Date : 10/2/2024

Page No : 12

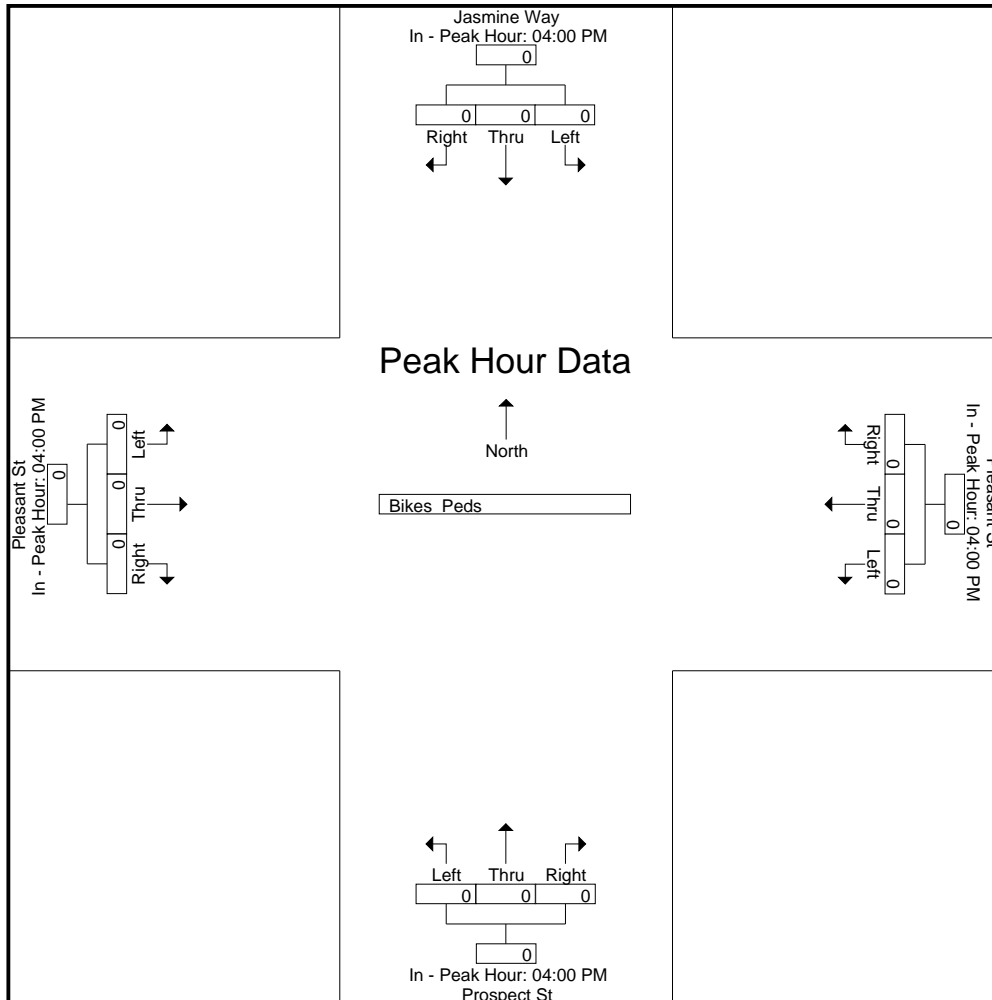



# Accurate Counts

978-664-2565

N/S Street : Vernon Street  
 E/W Street : Pleasant Street  
 City/State : Bridgewater, MA  
 Weather : Clear

File Name : 202700B5  
 Site Code : 20270005  
 Start Date : 10/2/2024  
 Page No : 1

### Groups Printed- Cars - Trucks

Start Time	Pleasant St From East		Vernon St From South		Pleasant St From West		Int. Total
	Left	Thru	Left	Right	Thru	Right	
07:00 AM	22	199	0	96	232	1	550
07:15 AM	33	243	1	30	211	1	519
07:30 AM	18	223	2	39	199	1	482
07:45 AM	19	189	0	53	203	1	465
<b>Total</b>	<b>92</b>	<b>854</b>	<b>3</b>	<b>218</b>	<b>845</b>	<b>4</b>	<b>2016</b>
08:00 AM	25	200	1	59	192	0	477
08:15 AM	25	203	0	31	222	0	481
08:30 AM	15	160	2	32	201	1	411
08:45 AM	22	148	1	35	164	0	370
<b>Total</b>	<b>87</b>	<b>711</b>	<b>4</b>	<b>157</b>	<b>779</b>	<b>1</b>	<b>1739</b>
<b>Grand Total</b>	<b>179</b>	<b>1565</b>	<b>7</b>	<b>375</b>	<b>1624</b>	<b>5</b>	<b>3755</b>
Apprch %	10.3	89.7	1.8	98.2	99.7	0.3	
Total %	4.8	41.7	0.2	10	43.2	0.1	
Cars	172	1514	6	366	1556	5	3619
% Cars	96.1	96.7	85.7	97.6	95.8	100	96.4
Trucks	7	51	1	9	68	0	136
% Trucks	3.9	3.3	14.3	2.4	4.2	0	3.6

Start Time	Pleasant St From East			Vernon St From South			Pleasant St From West			Int. Total
	Left	Thru	App. Total	Left	Right	App. Total	Thru	Right	App. Total	
Peak Hour Analysis From 07:00 AM to 08:45 AM - Peak 1 of 1										
Peak Hour for Entire Intersection Begins at 07:00 AM										
07:00 AM	22	199	221	0	<b>96</b>	<b>96</b>	<b>232</b>	<b>1</b>	<b>233</b>	<b>550</b>
07:15 AM	<b>33</b>	<b>243</b>	<b>276</b>	1	30	31	211	1	212	519
07:30 AM	18	223	241	<b>2</b>	39	41	199	1	200	482
07:45 AM	19	189	208	0	53	53	203	1	204	465
<b>Total Volume</b>	<b>92</b>	<b>854</b>	<b>946</b>	<b>3</b>	<b>218</b>	<b>221</b>	<b>845</b>	<b>4</b>	<b>849</b>	<b>2016</b>
% App. Total	9.7	90.3		1.4	98.6		99.5	0.5		
PHF	.697	.879	.857	.375	.568	.576	.911	1.00	.911	.916
Cars	87	827	914	3	213	216	812	4	816	1946
% Cars	94.6	96.8	96.6	100	97.7	97.7	96.1	100	96.1	96.5
Trucks	5	27	32	0	5	5	33	0	33	70
% Trucks	5.4	3.2	3.4	0	2.3	2.3	3.9	0	3.9	3.5

# Accurate Counts

978-664-2565

File Name : 202700B5

Site Code : 20270005

Start Date : 10/2/2024

Page No : 2

N/S Street : Vernon Street  
 E/W Street : Pleasant Street  
 City/State : Bridgewater, MA  
 Weather : Clear

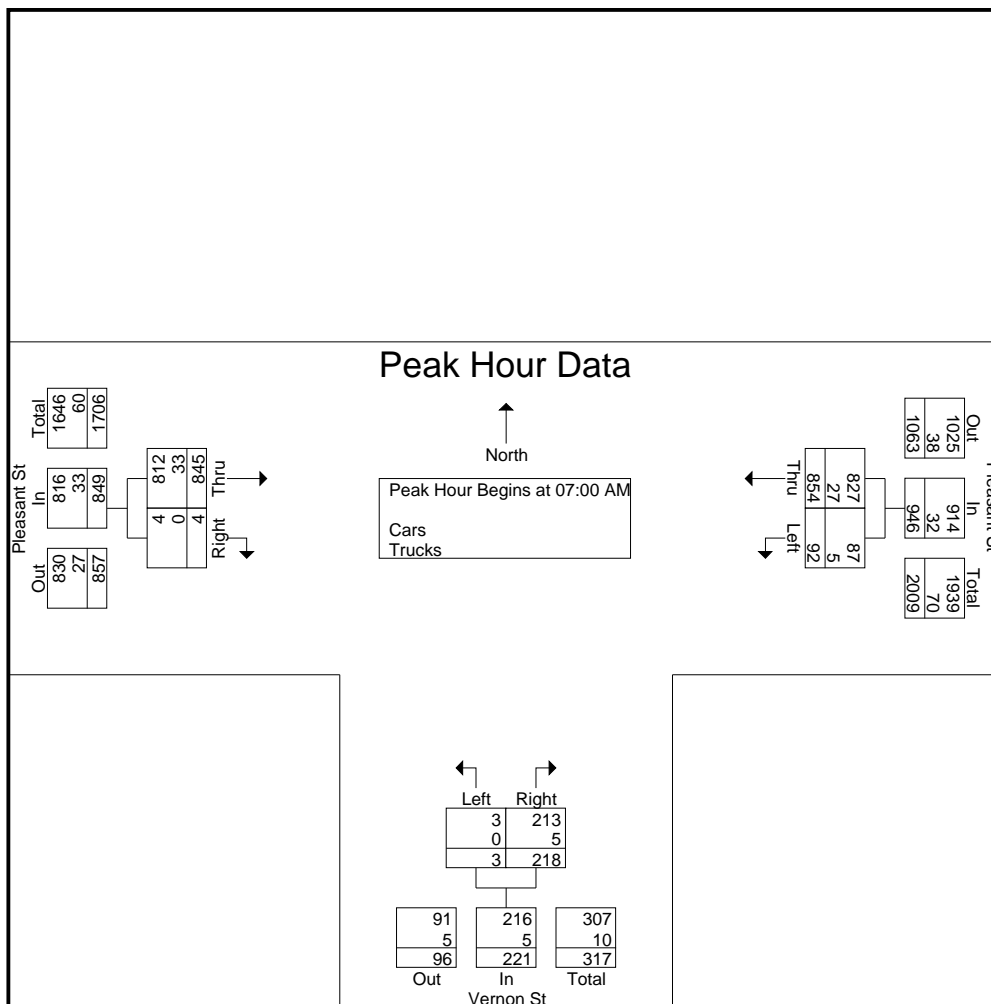

**Peak Hour Analysis From 07:00 AM to 08:45 AM - Peak 1 of 1**

**Peak Hour for Each Approach Begins at:**

	07:15 AM			07:00 AM			07:00 AM		
+0 mins.	33	243	276	0	96	96	232	1	233
+15 mins.	18	223	241	1	30	31	211	1	212
+30 mins.	19	189	208	2	39	41	199	1	200
+45 mins.	25	200	225	0	53	53	203	1	204
Total Volume	95	855	950	3	218	221	845	4	849
% App. Total	10	90		1.4	98.6		99.5	0.5	
PHF	.720	.880	.861	.375	.568	.576	.911	1.000	.911
Cars	92	832	924	3	213	216	812	4	816
% Cars	96.8	97.3	97.3	100	97.7	97.7	96.1	100	96.1
Trucks	3	23	26	0	5	5	33	0	33
% Trucks	3.2	2.7	2.7	0	2.3	2.3	3.9	0	3.9

# Accurate Counts

978-664-2565

File Name : 202700B5

Site Code : 20270005

Start Date : 10/2/2024

Page No : 3

N/S Street : Vernon Street  
 E/W Street : Pleasant Street  
 City/State : Bridgewater, MA  
 Weather : Clear

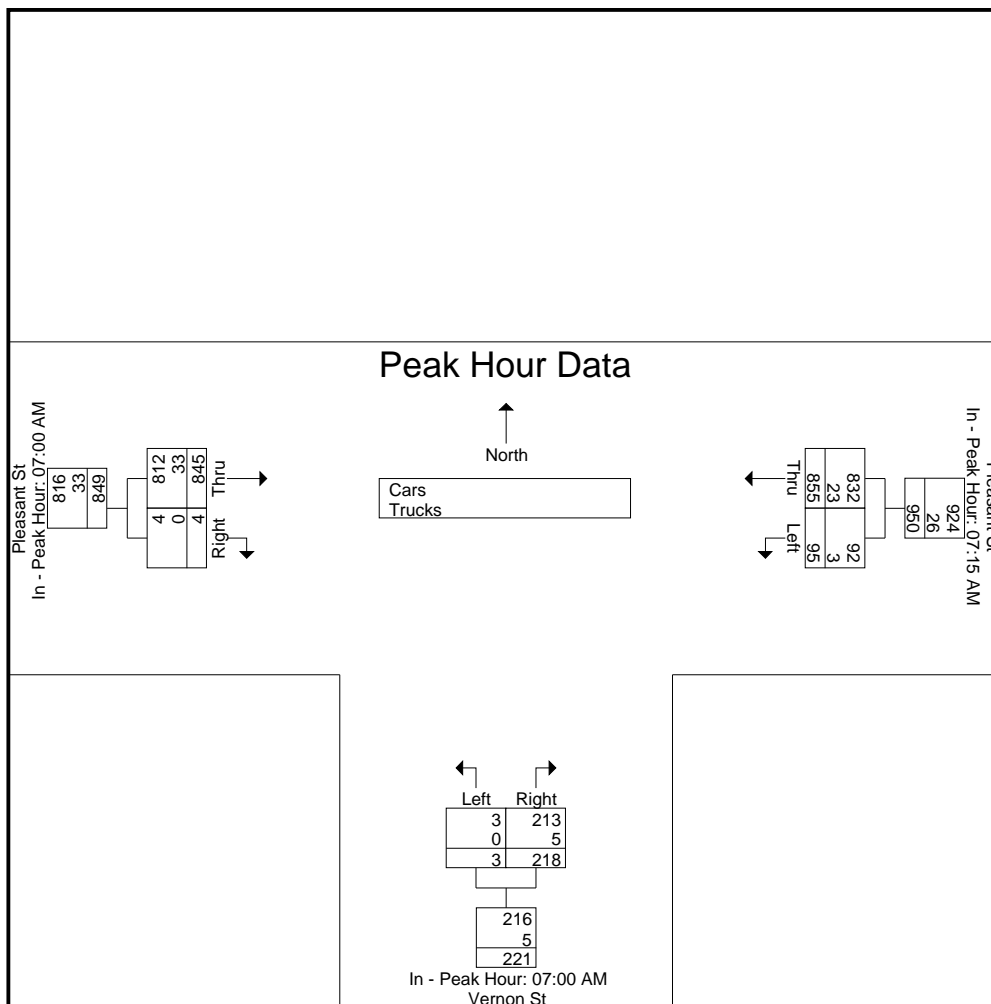

# Accurate Counts

978-664-2565

N/S Street : Vernon Street  
 E/W Street : Pleasant Street  
 City/State : Bridgewater, MA  
 Weather : Clear

File Name : 202700B5  
 Site Code : 20270005  
 Start Date : 10/2/2024  
 Page No : 4

## Groups Printed- Cars

Start Time	Pleasant St From East		Vernon St From South		Pleasant St From West		Int. Total
	Left	Thru	Left	Right	Thru	Right	
07:00 AM	20	190	0	93	220	1	524
07:15 AM	32	238	1	28	203	1	503
07:30 AM	18	215	2	39	191	1	466
07:45 AM	17	184	0	53	198	1	453
<b>Total</b>	<b>87</b>	<b>827</b>	<b>3</b>	<b>213</b>	<b>812</b>	<b>4</b>	<b>1946</b>
08:00 AM	25	195	1	57	182	0	460
08:15 AM	24	192	0	30	215	0	461
08:30 AM	14	153	1	31	193	1	393
08:45 AM	22	147	1	35	154	0	359
<b>Total</b>	<b>85</b>	<b>687</b>	<b>3</b>	<b>153</b>	<b>744</b>	<b>1</b>	<b>1673</b>
<b>Grand Total</b>	<b>172</b>	<b>1514</b>	<b>6</b>	<b>366</b>	<b>1556</b>	<b>5</b>	<b>3619</b>
Apprch %	10.2	89.8	1.6	98.4	99.7	0.3	
Total %	4.8	41.8	0.2	10.1	43	0.1	

Start Time	Pleasant St From East			Vernon St From South			Pleasant St From West			Int. Total
	Left	Thru	App. Total	Left	Right	App. Total	Thru	Right	App. Total	
Peak Hour Analysis From 07:00 AM to 08:45 AM - Peak 1 of 1										
Peak Hour for Entire Intersection Begins at 07:00 AM										
07:00 AM	20	190	210	0	<b>93</b>	<b>93</b>	<b>220</b>	<b>1</b>	<b>221</b>	<b>524</b>
07:15 AM	<b>32</b>	<b>238</b>	<b>270</b>	1	28	29	203	1	204	503
07:30 AM	18	215	233	<b>2</b>	39	41	191	1	192	466
07:45 AM	17	184	201	0	53	53	198	1	199	453
<b>Total Volume</b>	<b>87</b>	<b>827</b>	<b>914</b>	<b>3</b>	<b>213</b>	<b>216</b>	<b>812</b>	<b>4</b>	<b>816</b>	<b>1946</b>
% App. Total	9.5	90.5		1.4	98.6		99.5	0.5		
PHF	.680	.869	.846	.375	.573	.581	.923	1.00	.923	.928

# Accurate Counts

978-664-2565

N/S Street : Vernon Street  
 E/W Street : Pleasant Street  
 City/State : Bridgewater, MA  
 Weather : Clear

File Name : 202700B5  
 Site Code : 20270005  
 Start Date : 10/2/2024  
 Page No : 5

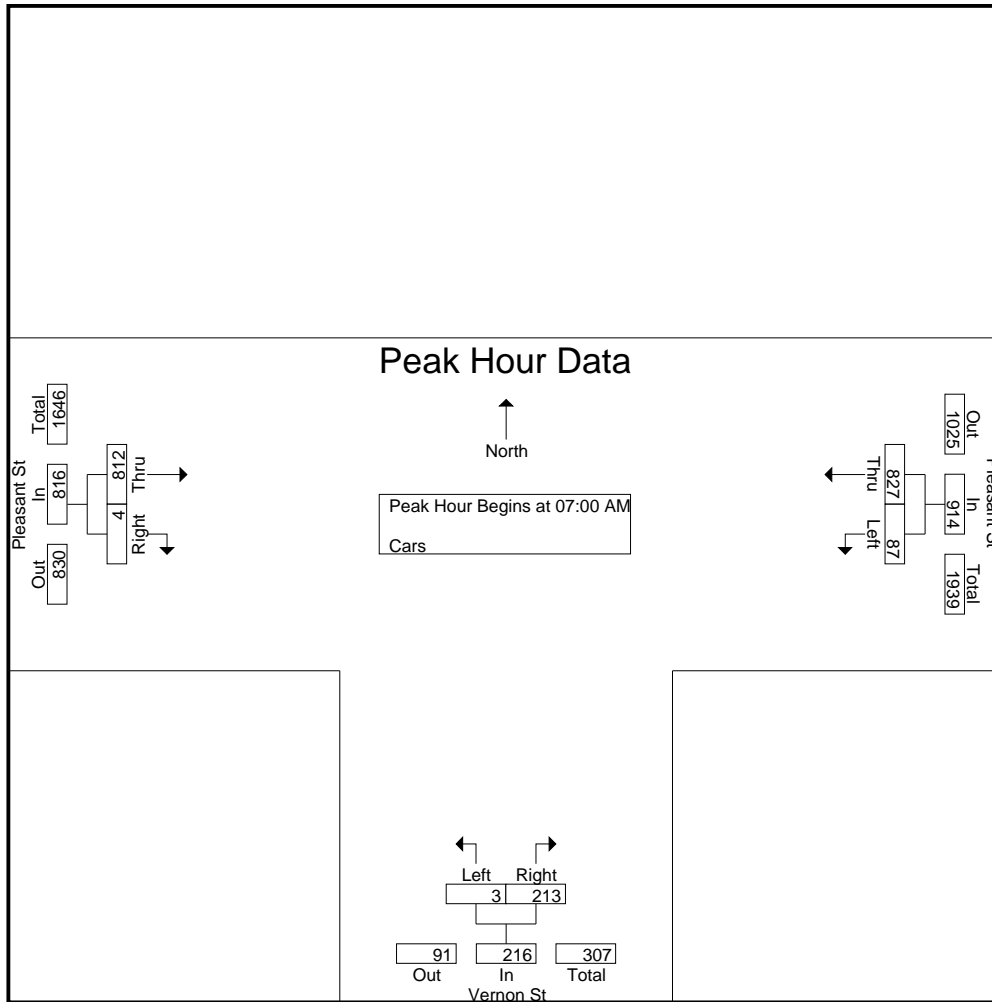

**Peak Hour Analysis From 07:00 AM to 08:45 AM - Peak 1 of 1**

Peak Hour for Each Approach Begins at:

	07:15 AM			07:00 AM			07:00 AM		
+0 mins.	32	238	270	0	93	93	220	1	221
+15 mins.	18	215	233	1	28	29	203	1	204
+30 mins.	17	184	201	2	39	41	191	1	192
+45 mins.	25	195	220	0	53	53	198	1	199
<b>Total Volume</b>	92	832	924	3	213	216	812	4	816
<b>% App. Total</b>	10	90		1.4	98.6		99.5	0.5	
<b>PHF</b>	.719	.874	.856	.375	.573	.581	.923	1.000	.923

# Accurate Counts

978-664-2565

File Name : 202700B5

Site Code : 20270005

Start Date : 10/2/2024

Page No : 6

N/S Street : Vernon Street  
E/W Street : Pleasant Street  
City/State : Bridgewater, MA  
Weather : Clear

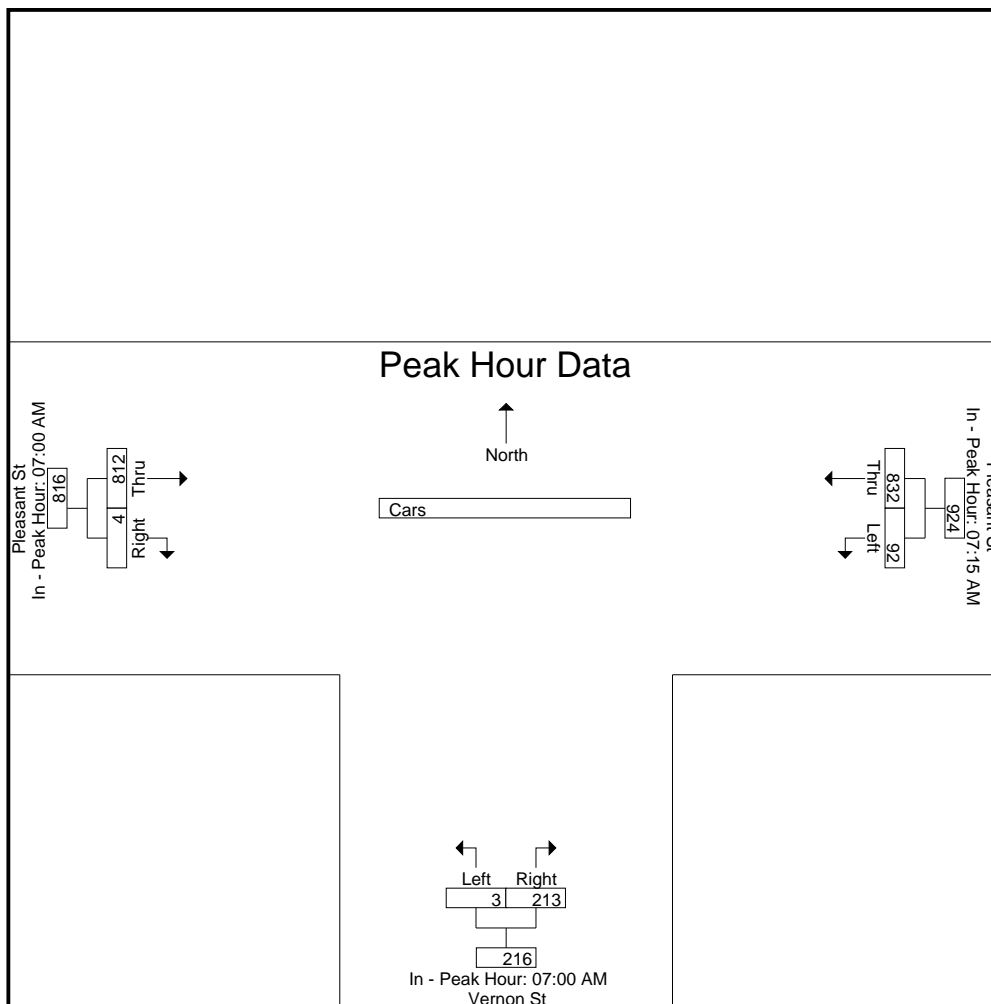

# Accurate Counts

978-664-2565

N/S Street : Vernon Street  
 E/W Street : Pleasant Street  
 City/State : Bridgewater, MA  
 Weather : Clear

File Name : 202700B5  
 Site Code : 20270005  
 Start Date : 10/2/2024  
 Page No : 7

### Groups Printed- Trucks

Start Time	Pleasant St From East		Vernon St From South		Pleasant St From West		Int. Total
	Left	Thru	Left	Right	Thru	Right	
07:00 AM	2	9	0	3	12	0	26
07:15 AM	1	5	0	2	8	0	16
07:30 AM	0	8	0	0	8	0	16
07:45 AM	2	5	0	0	5	0	12
<b>Total</b>	<b>5</b>	<b>27</b>	<b>0</b>	<b>5</b>	<b>33</b>	<b>0</b>	<b>70</b>
08:00 AM	0	5	0	2	10	0	17
08:15 AM	1	11	0	1	7	0	20
08:30 AM	1	7	1	1	8	0	18
08:45 AM	0	1	0	0	10	0	11
<b>Total</b>	<b>2</b>	<b>24</b>	<b>1</b>	<b>4</b>	<b>35</b>	<b>0</b>	<b>66</b>
<b>Grand Total</b>	<b>7</b>	<b>51</b>	<b>1</b>	<b>9</b>	<b>68</b>	<b>0</b>	<b>136</b>
Apprch %	12.1	87.9	10	90	100	0	
Total %	5.1	37.5	0.7	6.6	50	0	

Start Time	Pleasant St From East			Vernon St From South			Pleasant St From West			Int. Total
	Left	Thru	App. Total	Left	Right	App. Total	Thru	Right	App. Total	
Peak Hour Analysis From 07:00 AM to 08:45 AM - Peak 1 of 1										
Peak Hour for Entire Intersection Begins at 07:00 AM										
07:00 AM	2	9	11	0	3	3	12	0	12	26
07:15 AM	1	5	6	0	2	2	8	0	8	16
07:30 AM	0	8	8	0	0	0	8	0	8	16
07:45 AM	2	5	7	0	0	0	5	0	5	12
<b>Total Volume</b>	<b>5</b>	<b>27</b>	<b>32</b>	<b>0</b>	<b>5</b>	<b>5</b>	<b>33</b>	<b>0</b>	<b>33</b>	<b>70</b>
% App. Total	15.6	84.4		0	100		100	0		
PHF	.625	.750	.727	.000	.417	.417	.688	.000	.688	.673

# Accurate Counts

978-664-2565

N/S Street : Vernon Street  
 E/W Street : Pleasant Street  
 City/State : Bridgewater, MA  
 Weather : Clear

File Name : 202700B5  
 Site Code : 20270005  
 Start Date : 10/2/2024  
 Page No : 8

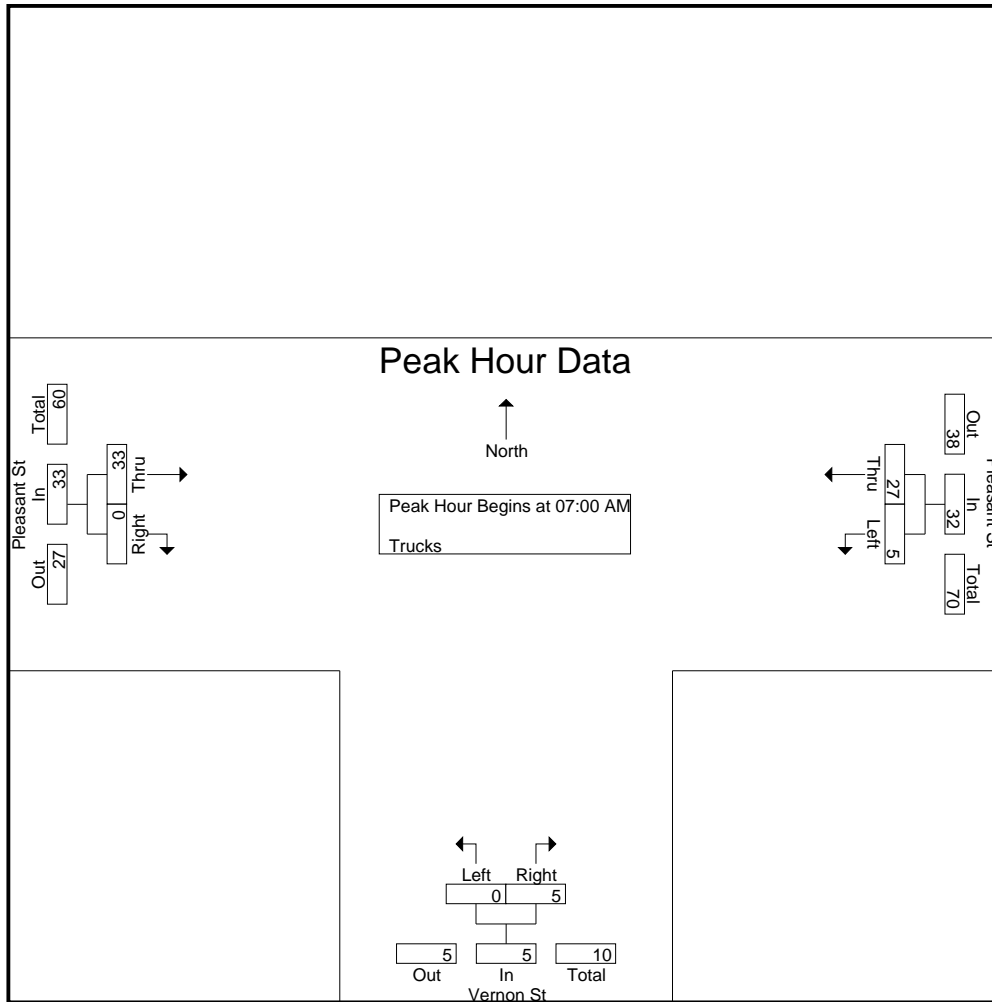

**Peak Hour Analysis From 07:00 AM to 08:45 AM - Peak 1 of 1**

Peak Hour for Each Approach Begins at:

	07:00 AM			07:00 AM			08:00 AM		
+0 mins.	2	9	11	0	3	3	10	0	10
+15 mins.	1	5	6	0	2	2	7	0	7
+30 mins.	0	8	8	0	0	0	8	0	8
+45 mins.	2	5	7	0	0	0	10	0	10
<b>Total Volume</b>	5	27	32	0	5	5	35	0	35
<b>% App. Total</b>	15.6	84.4		0	100		100	0	
<b>PHF</b>	.625	.750	.727	.000	.417	.417	.875	.000	.875



# Accurate Counts

978-664-2565

File Name : 202700B5

Site Code : 20270005

Start Date : 10/2/2024

Page No : 9

N/S Street : Vernon Street  
E/W Street : Pleasant Street  
City/State : Bridgewater, MA  
Weather : Clear

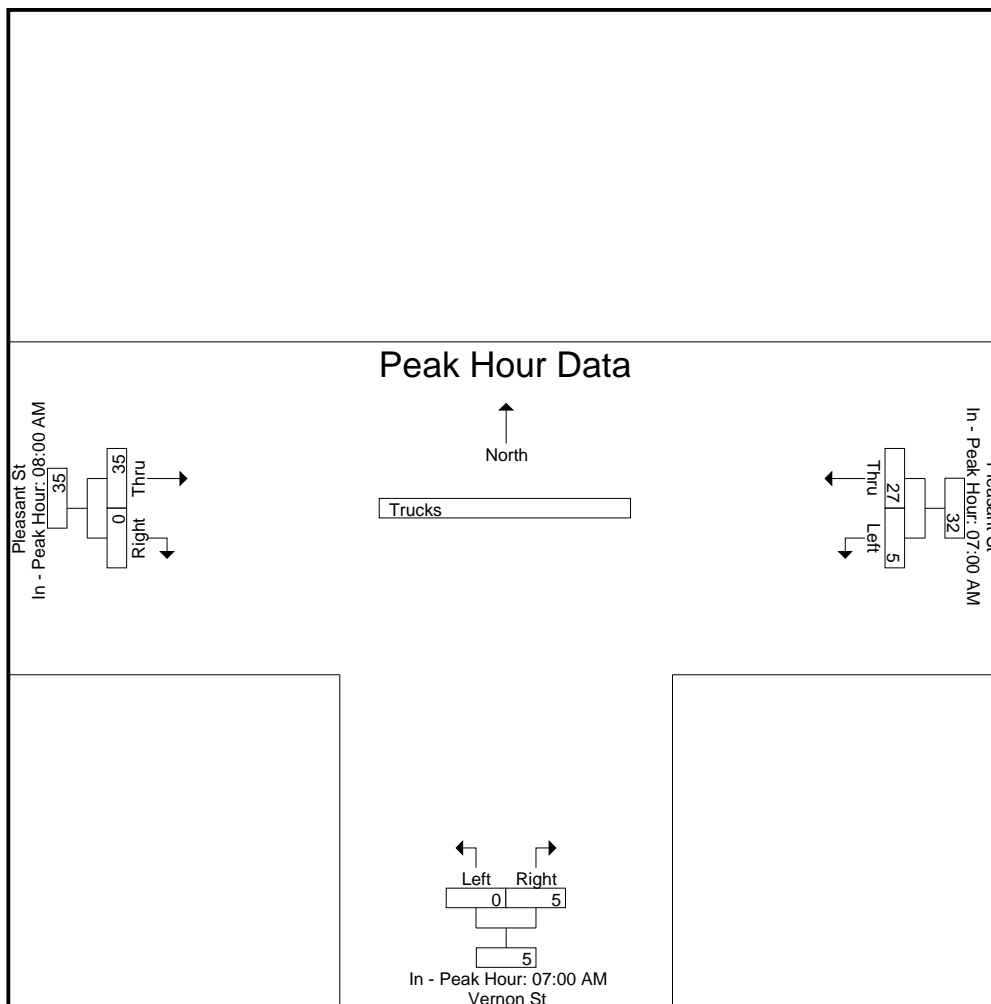

# Accurate Counts

978-664-2565

N/S Street : Vernon Street  
 E/W Street : Pleasant Street  
 City/State : Bridgewater, MA  
 Weather : Clear

File Name : 202700B5  
 Site Code : 20270005  
 Start Date : 10/2/2024  
 Page No : 10

### Groups Printed- Bikes Peds

Start Time	Pleasant St From East			Vernon St From South			Pleasant St From West			Exclu. Total	Inclu. Total	Int. Total
	Left	Thru	Peds	Left	Right	Peds	Thru	Right	Peds			
07:00 AM	0	0	0	0	0	0	0	0	0	0	0	0
07:15 AM	0	0	0	0	0	0	0	0	0	0	0	0
07:30 AM	0	0	0	0	0	0	0	0	0	0	0	0
07:45 AM	0	0	0	0	1	0	0	0	0	0	1	1
<b>Total</b>	0	0	0	0	1	0	0	0	0	0	1	1
08:00 AM	0	0	0	0	0	0	0	0	0	0	0	0
08:15 AM	0	0	1	0	0	0	0	0	0	1	0	1
08:30 AM	0	0	0	0	0	0	0	0	0	0	0	0
08:45 AM	0	0	0	0	0	0	0	0	0	0	0	0
<b>Total</b>	0	0	1	0	0	0	0	0	0	1	0	1
<b>Grand Total</b>	0	0	1	0	1	0	0	0	0	1	1	2
Apprch %	0	0		0	100		0	0				
Total %	0	0		0	100		0	0		50	50	

Start Time	Pleasant St From East			Vernon St From South			Pleasant St From West			Int. Total
	Left	Thru	App. Total	Left	Right	App. Total	Thru	Right	App. Total	
Peak Hour Analysis From 07:00 AM to 08:45 AM - Peak 1 of 1										
Peak Hour for Entire Intersection Begins at 07:00 AM										
07:00 AM	0	0	0	0	0	0	0	0	0	0
07:15 AM	0	0	0	0	0	0	0	0	0	0
07:30 AM	0	0	0	0	0	0	0	0	0	0
07:45 AM	0	0	0	0	1	1	0	0	0	1
<b>Total Volume</b>	0	0	0	0	1	1	0	0	0	1
<b>% App. Total</b>	0	0		0	100		0	0		
<b>PHF</b>	.000	.000	.000	.000	.250	.250	.000	.000	.000	.250

# Accurate Counts

978-664-2565

N/S Street : Vernon Street  
 E/W Street : Pleasant Street  
 City/State : Bridgewater, MA  
 Weather : Clear

File Name : 202700B5  
 Site Code : 20270005  
 Start Date : 10/2/2024  
 Page No : 11

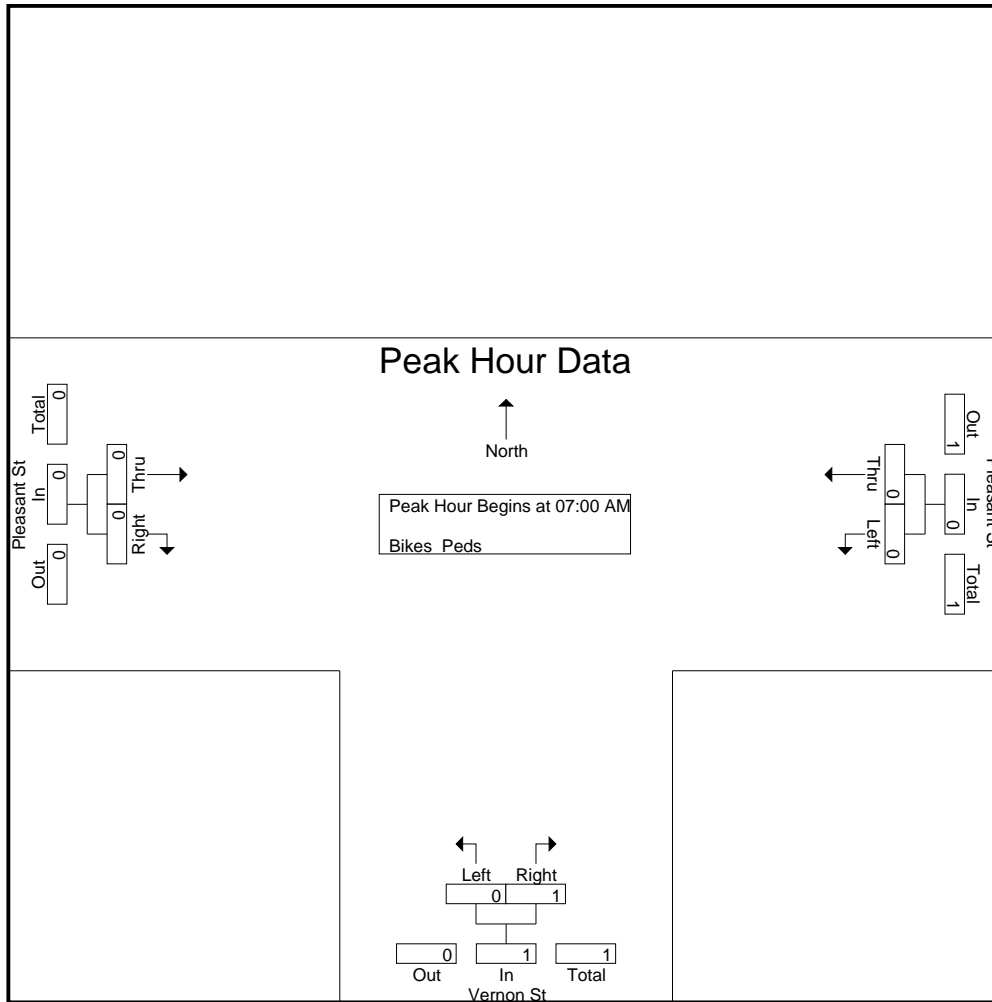

**Peak Hour Analysis From 07:00 AM to 08:45 AM - Peak 1 of 1**

Peak Hour for Each Approach Begins at:

	07:00 AM			07:00 AM			07:00 AM		
+0 mins.	0	0	0	0	0	0	0	0	0
+15 mins.	0	0	0	0	0	0	0	0	0
+30 mins.	0	0	0	0	0	0	0	0	0
+45 mins.	0	0	0	0	1	1	0	0	0
Total Volume	0	0	0	0	1	1	0	0	0
% App. Total	0	0	0	0	100	100	0	0	0
PHF	.000	.000	.000	.000	.250	.250	.000	.000	.000

# Accurate Counts

978-664-2565

File Name : 202700B5

Site Code : 20270005

Start Date : 10/2/2024

Page No : 12

N/S Street : Vernon Street  
E/W Street : Pleasant Street  
City/State : Bridgewater, MA  
Weather : Clear

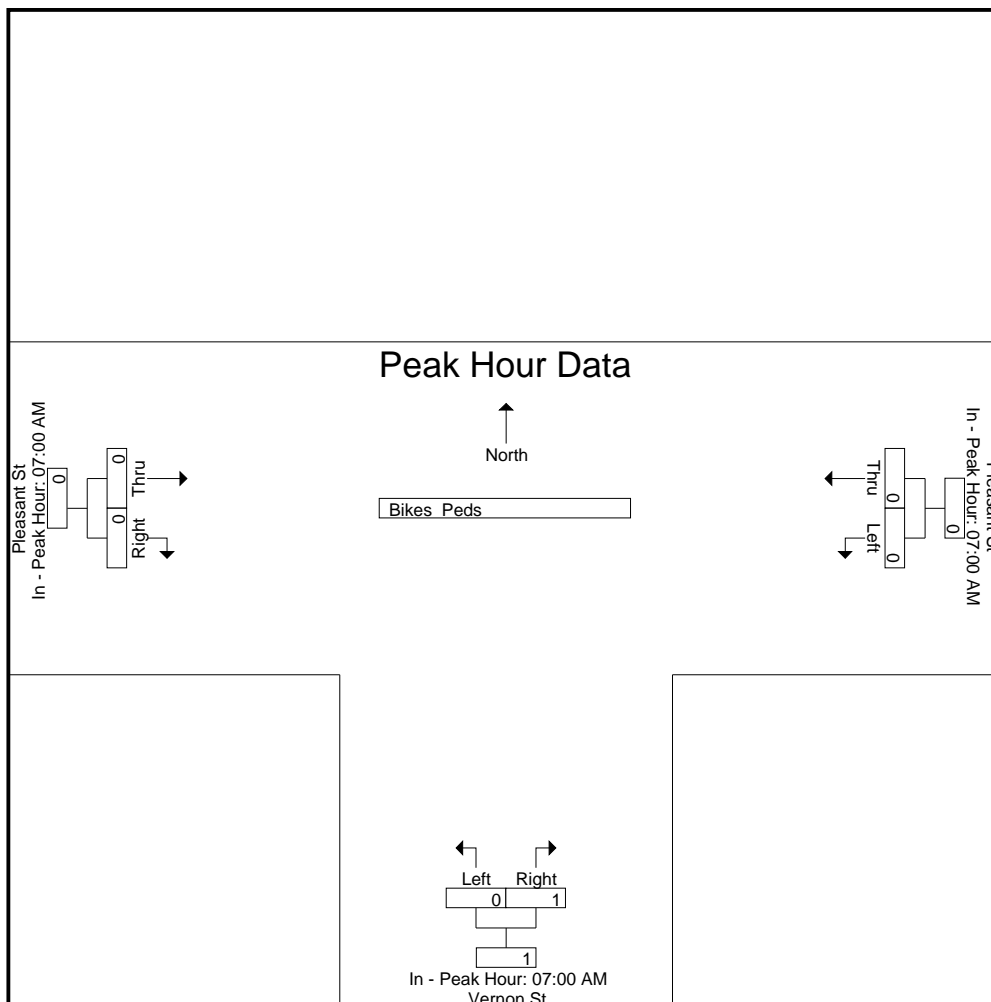

# Accurate Counts

978-664-2565

N/S Street : Vernon Street  
 E/W Street : Pleasant Street  
 City/State : Bridgewater, MA  
 Weather : Clear

File Name : 202700B5  
 Site Code : 20270005  
 Start Date : 10/2/2024  
 Page No : 1

### Groups Printed- Cars - Trucks

Start Time	Pleasant St From East		Vernon St From South		Pleasant St From West		Int. Total
	Left	Thru	Left	Right	Thru	Right	
04:00 PM	59	187	0	28	212	2	488
04:15 PM	70	190	0	35	210	2	507
04:30 PM	73	179	0	40	189	1	482
04:45 PM	79	163	0	41	188	0	471
<b>Total</b>	<b>281</b>	<b>719</b>	<b>0</b>	<b>144</b>	<b>799</b>	<b>5</b>	<b>1948</b>
05:00 PM	91	182	1	47	207	1	529
05:15 PM	77	201	1	39	213	3	534
05:30 PM	56	167	0	30	209	1	463
05:45 PM	52	153	0	36	202	1	444
<b>Total</b>	<b>276</b>	<b>703</b>	<b>2</b>	<b>152</b>	<b>831</b>	<b>6</b>	<b>1970</b>
<b>Grand Total</b>	<b>557</b>	<b>1422</b>	<b>2</b>	<b>296</b>	<b>1630</b>	<b>11</b>	<b>3918</b>
Apprch %	28.1	71.9	0.7	99.3	99.3	0.7	
Total %	14.2	36.3	0.1	7.6	41.6	0.3	
Cars	554	1408	2	296	1599	11	3870
% Cars	99.5	99	100	100	98.1	100	98.8
Trucks	3	14	0	0	31	0	48
% Trucks	0.5	1	0	0	1.9	0	1.2

Start Time	Pleasant St From East			Vernon St From South			Pleasant St From West			Int. Total
	Left	Thru	App. Total	Left	Right	App. Total	Thru	Right	App. Total	
Peak Hour Analysis From 04:00 PM to 05:45 PM - Peak 1 of 1										
Peak Hour for Entire Intersection Begins at 04:30 PM										
04:30 PM	73	179	252	0	40	40	189	1	190	482
04:45 PM	79	163	242	0	41	41	188	0	188	471
05:00 PM	<b>91</b>	<b>182</b>	<b>273</b>	<b>1</b>	<b>47</b>	<b>48</b>	<b>207</b>	<b>1</b>	<b>208</b>	<b>529</b>
05:15 PM	77	<b>201</b>	<b>278</b>	1	39	40	<b>213</b>	<b>3</b>	<b>216</b>	<b>534</b>
<b>Total Volume</b>	<b>320</b>	<b>725</b>	<b>1045</b>	<b>2</b>	<b>167</b>	<b>169</b>	<b>797</b>	<b>5</b>	<b>802</b>	<b>2016</b>
% App. Total	30.6	69.4		1.2	98.8		99.4	0.6		
PHF	.879	.902	.940	.500	.888	.880	.935	.417	.928	.944
Cars	318	719	1037	2	167	169	782	5	787	1993
% Cars	99.4	99.2	99.2	100	100	100	98.1	100	98.1	98.9
Trucks	2	6	8	0	0	0	15	0	15	23
% Trucks	0.6	0.8	0.8	0	0	0	1.9	0	1.9	1.1

# Accurate Counts

978-664-2565

N/S Street : Vernon Street  
 E/W Street : Pleasant Street  
 City/State : Bridgewater, MA  
 Weather : Clear

File Name : 202700B5  
 Site Code : 20270005  
 Start Date : 10/2/2024  
 Page No : 2

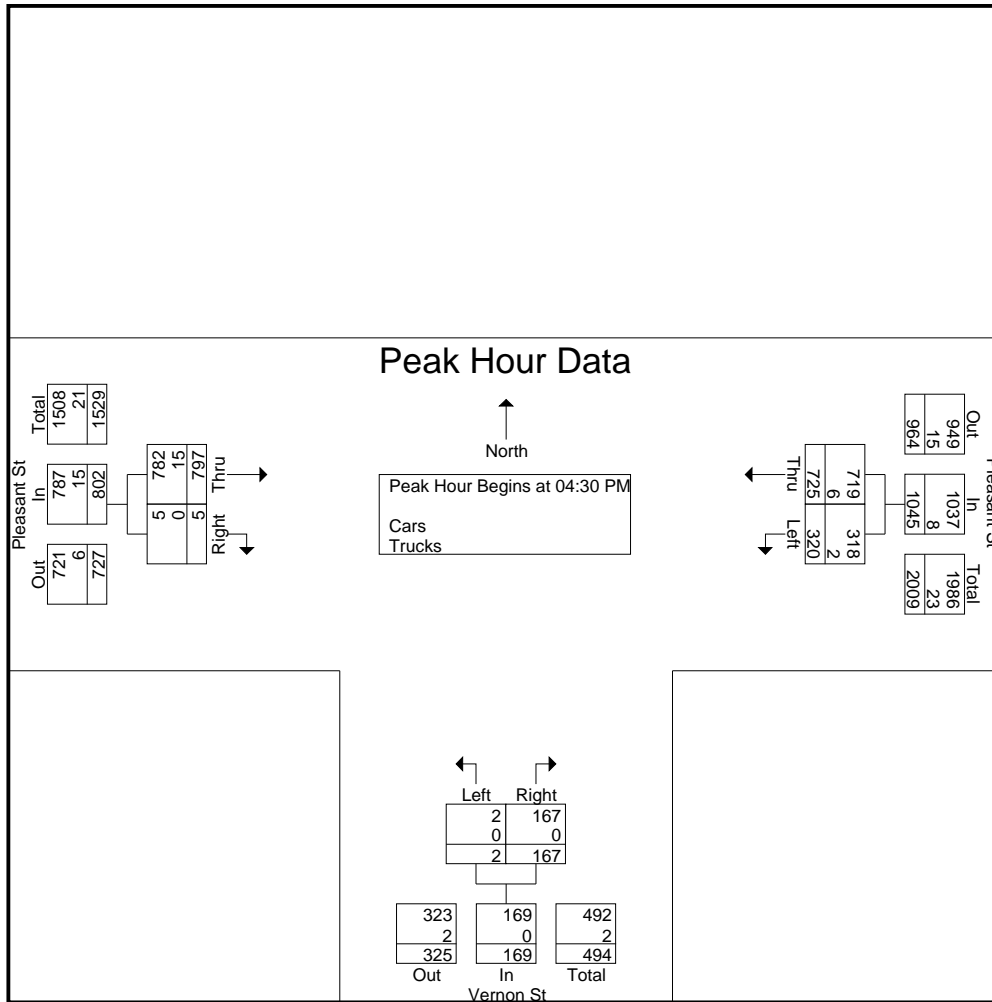

**Peak Hour Analysis From 04:00 PM to 05:45 PM - Peak 1 of 1**

Peak Hour for Each Approach Begins at:

	04:30 PM			04:30 PM			05:00 PM		
+0 mins.	73	179	252	0	40	40	207	1	208
+15 mins.	79	163	242	0	41	41	<b>213</b>	<b>3</b>	<b>216</b>
+30 mins.	<b>91</b>	<b>182</b>	<b>273</b>	<b>1</b>	<b>47</b>	<b>48</b>	209	1	210
+45 mins.	77	<b>201</b>	<b>278</b>	1	39	40	202	1	203
Total Volume	320	725	1045	2	167	169	831	6	837
% App. Total	30.6	69.4		1.2	98.8		99.3	0.7	
PHF	.879	.902	.940	.500	.888	.880	.975	.500	.969
Cars	318	719	1037	2	167	169	821	6	827
% Cars	99.4	99.2	99.2	100	100	100	98.8	100	98.8
Trucks	2	6	8	0	0	0	10	0	10
% Trucks	0.6	0.8	0.8	0	0	0	1.2	0	1.2

# Accurate Counts

978-664-2565

File Name : 202700B5

Site Code : 20270005

Start Date : 10/2/2024

Page No : 3

N/S Street : Vernon Street

E/W Street : Pleasant Street

City/State : Bridgewater, MA

Weather : Clear

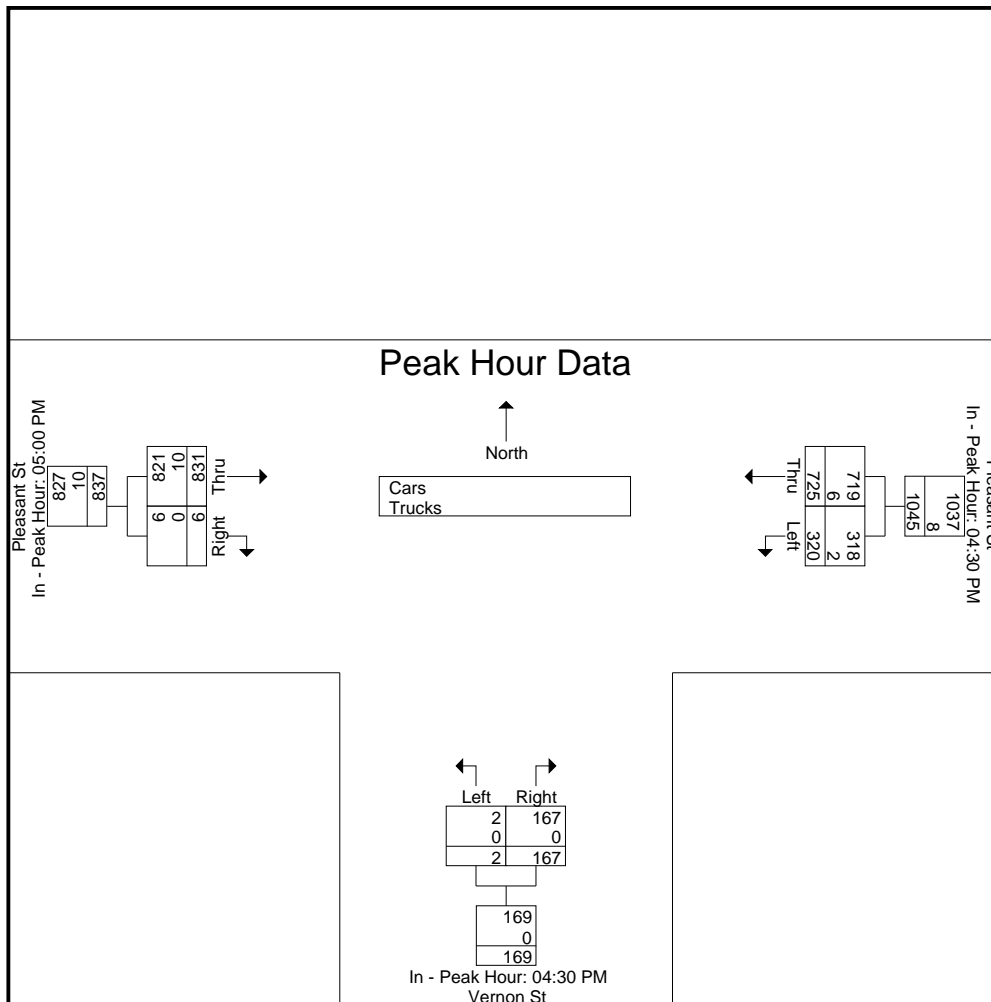

# Accurate Counts

978-664-2565

N/S Street : Vernon Street  
 E/W Street : Pleasant Street  
 City/State : Bridgewater, MA  
 Weather : Clear

File Name : 202700B5  
 Site Code : 20270005  
 Start Date : 10/2/2024  
 Page No : 4

### Groups Printed- Cars

Start Time	Pleasant St From East		Vernon St From South		Pleasant St From West		Int. Total
	Left	Thru	Left	Right	Thru	Right	
04:00 PM	59	184	0	28	206	2	479
04:15 PM	69	186	0	35	204	2	496
04:30 PM	73	177	0	40	183	1	474
04:45 PM	79	161	0	41	185	0	466
<b>Total</b>	<b>280</b>	<b>708</b>	<b>0</b>	<b>144</b>	<b>778</b>	<b>5</b>	<b>1915</b>
05:00 PM	90	180	1	47	204	1	523
05:15 PM	76	201	1	39	210	3	530
05:30 PM	56	166	0	30	208	1	461
05:45 PM	52	153	0	36	199	1	441
<b>Total</b>	<b>274</b>	<b>700</b>	<b>2</b>	<b>152</b>	<b>821</b>	<b>6</b>	<b>1955</b>
<b>Grand Total</b>	<b>554</b>	<b>1408</b>	<b>2</b>	<b>296</b>	<b>1599</b>	<b>11</b>	<b>3870</b>
Apprch %	28.2	71.8	0.7	99.3	99.3	0.7	
Total %	14.3	36.4	0.1	7.6	41.3	0.3	

Start Time	Pleasant St From East			Vernon St From South			Pleasant St From West			Int. Total
	Left	Thru	App. Total	Left	Right	App. Total	Thru	Right	App. Total	
Peak Hour Analysis From 04:00 PM to 05:45 PM - Peak 1 of 1										
Peak Hour for Entire Intersection Begins at 04:30 PM										
04:30 PM	73	177	250	0	40	40	183	1	184	474
04:45 PM	79	161	240	0	41	41	185	0	185	466
05:00 PM	<b>90</b>	180	270	<b>1</b>	<b>47</b>	<b>48</b>	204	1	205	523
05:15 PM	76	<b>201</b>	<b>277</b>	1	39	40	<b>210</b>	<b>3</b>	<b>213</b>	<b>530</b>
<b>Total Volume</b>	318	719	1037	2	167	169	782	5	787	1993
% App. Total	30.7	69.3		1.2	98.8		99.4	0.6		
PHF	.883	.894	.936	.500	.888	.880	.931	.417	.924	.940



# Accurate Counts

978-664-2565

N/S Street : Vernon Street  
 E/W Street : Pleasant Street  
 City/State : Bridgewater, MA  
 Weather : Clear

File Name : 202700B5  
 Site Code : 20270005  
 Start Date : 10/2/2024  
 Page No : 5

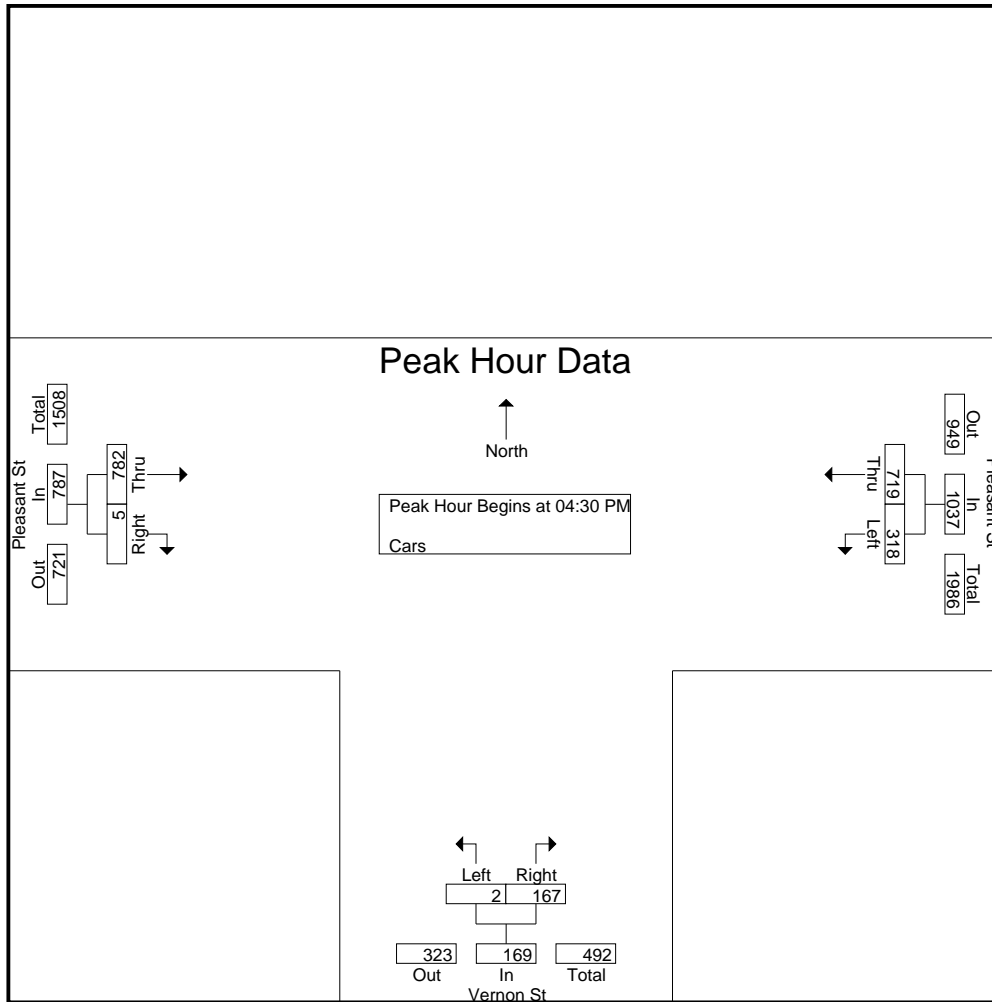

**Peak Hour Analysis From 04:00 PM to 05:45 PM - Peak 1 of 1**

Peak Hour for Each Approach Begins at:

	04:30 PM			04:30 PM			05:00 PM		
+0 mins.	73	177	250	0	40	40	204	1	205
+15 mins.	79	161	240	0	41	41	<b>210</b>	<b>3</b>	<b>213</b>
+30 mins.	<b>90</b>	180	270	<b>1</b>	<b>47</b>	<b>48</b>	208	1	209
+45 mins.	76	<b>201</b>	<b>277</b>	1	39	40	199	1	200
Total Volume	318	719	1037	2	167	169	821	6	827
% App. Total	30.7	69.3		1.2	98.8		99.3	0.7	
PHF	.883	.894	.936	.500	.888	.880	.977	.500	.971

# Accurate Counts

978-664-2565

N/S Street : Vernon Street  
E/W Street : Pleasant Street  
City/State : Bridgewater, MA  
Weather : Clear

File Name : 202700B5  
Site Code : 20270005  
Start Date : 10/2/2024  
Page No : 6

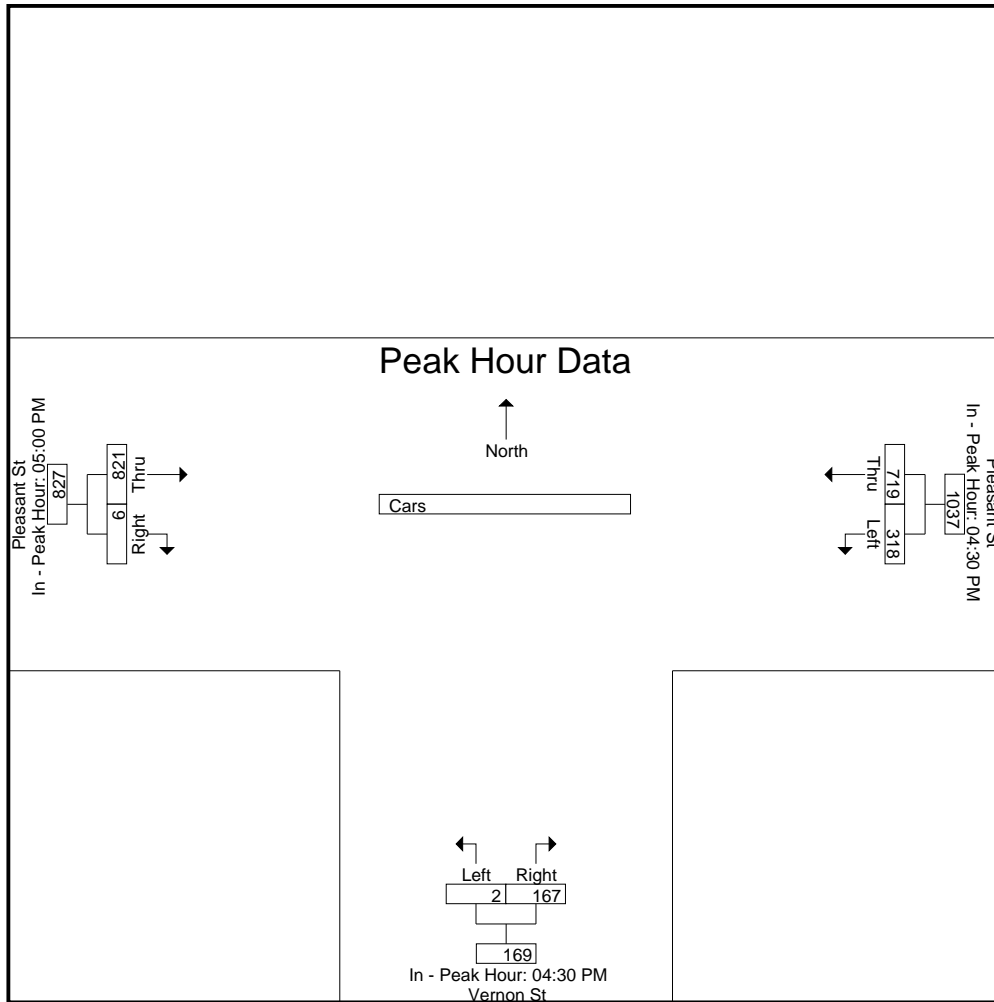

# Accurate Counts

978-664-2565

N/S Street : Vernon Street  
 E/W Street : Pleasant Street  
 City/State : Bridgewater, MA  
 Weather : Clear

File Name : 202700B5  
 Site Code : 20270005  
 Start Date : 10/2/2024  
 Page No : 7

### Groups Printed- Trucks

Start Time	Pleasant St From East		Vernon St From South		Pleasant St From West		Int. Total
	Left	Thru	Left	Right	Thru	Right	
04:00 PM	0	3	0	0	6	0	9
04:15 PM	1	4	0	0	6	0	11
04:30 PM	0	2	0	0	6	0	8
04:45 PM	0	2	0	0	3	0	5
<b>Total</b>	<b>1</b>	<b>11</b>	<b>0</b>	<b>0</b>	<b>21</b>	<b>0</b>	<b>33</b>
05:00 PM	1	2	0	0	3	0	6
05:15 PM	1	0	0	0	3	0	4
05:30 PM	0	1	0	0	1	0	2
05:45 PM	0	0	0	0	3	0	3
<b>Total</b>	<b>2</b>	<b>3</b>	<b>0</b>	<b>0</b>	<b>10</b>	<b>0</b>	<b>15</b>
<b>Grand Total</b>	<b>3</b>	<b>14</b>	<b>0</b>	<b>0</b>	<b>31</b>	<b>0</b>	<b>48</b>
Apprch %	17.6	82.4	0	0	100	0	
Total %	6.2	29.2	0	0	64.6	0	

Start Time	Pleasant St From East			Vernon St From South			Pleasant St From West			Int. Total
	Left	Thru	App. Total	Left	Right	App. Total	Thru	Right	App. Total	
Peak Hour Analysis From 04:00 PM to 05:45 PM - Peak 1 of 1										
Peak Hour for Entire Intersection Begins at 04:00 PM										
04:00 PM	0	3	3	0	0	0	6	0	6	9
04:15 PM	1	4	5	0	0	0	6	0	6	11
04:30 PM	0	2	2	0	0	0	6	0	6	8
04:45 PM	0	2	2	0	0	0	3	0	3	5
<b>Total Volume</b>	<b>1</b>	<b>11</b>	<b>12</b>	<b>0</b>	<b>0</b>	<b>0</b>	<b>21</b>	<b>0</b>	<b>21</b>	<b>33</b>
% App. Total	8.3	91.7		0	0		100	0		
PHF	.250	.688	.600	.000	.000	.000	.875	.000	.875	.750

# Accurate Counts

978-664-2565

N/S Street : Vernon Street  
 E/W Street : Pleasant Street  
 City/State : Bridgewater, MA  
 Weather : Clear

File Name : 202700B5  
 Site Code : 20270005  
 Start Date : 10/2/2024  
 Page No : 8

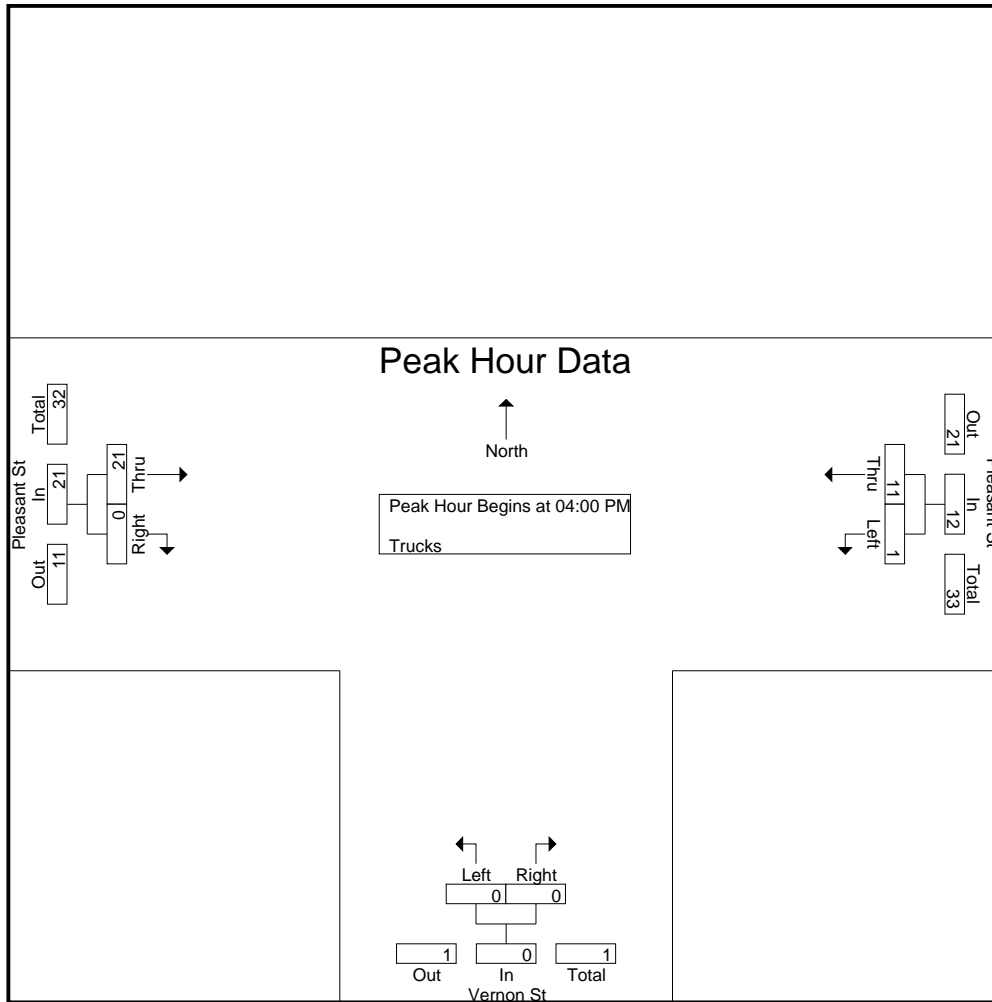

**Peak Hour Analysis From 04:00 PM to 05:45 PM - Peak 1 of 1**

Peak Hour for Each Approach Begins at:

	04:00 PM			04:00 PM			04:00 PM		
+0 mins.	0	3	3	0	0	0	6	0	6
+15 mins.	1	4	5	0	0	0	6	0	6
+30 mins.	0	2	2	0	0	0	6	0	6
+45 mins.	0	2	2	0	0	0	3	0	3
<b>Total Volume</b>	1	11	12	0	0	0	21	0	21
<b>% App. Total</b>	8.3	91.7		0	0		100	0	
<b>PHF</b>	.250	.688	.600	.000	.000	.000	.875	.000	.875

# Accurate Counts

978-664-2565

N/S Street : Vernon Street  
E/W Street : Pleasant Street  
City/State : Bridgewater, MA  
Weather : Clear

File Name : 202700B5  
Site Code : 20270005  
Start Date : 10/2/2024  
Page No : 9

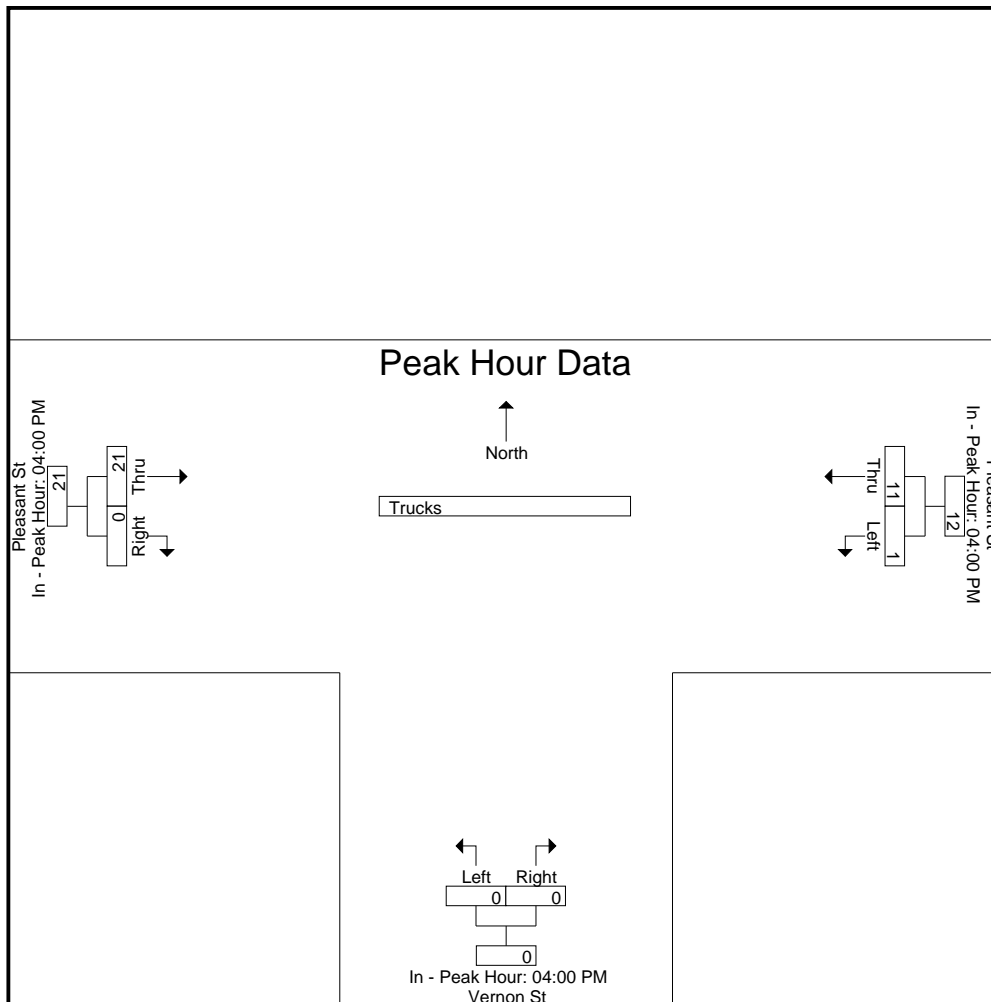

# Accurate Counts

978-664-2565

N/S Street : Vernon Street  
 E/W Street : Pleasant Street  
 City/State : Bridgewater, MA  
 Weather : Clear

File Name : 202700B5  
 Site Code : 20270005  
 Start Date : 10/2/2024  
 Page No : 10

### Groups Printed- Bikes Peds

Start Time	Pleasant St From East			Vernon St From South			Pleasant St From West			Exclu. Total	Inclu. Total	Int. Total
	Left	Thru	Peds	Left	Right	Peds	Thru	Right	Peds			
04:00 PM	0	0	0	0	0	0	0	0	0	0	0	0
04:15 PM	0	0	0	0	0	0	0	0	0	0	0	0
04:30 PM	0	0	0	0	0	0	2	0	0	0	2	2
04:45 PM	0	0	0	0	0	0	0	0	0	0	0	0
<b>Total</b>	0	0	0	0	0	0	2	0	0	0	2	2
05:00 PM	0	0	0	0	0	0	0	0	0	0	0	0
05:15 PM	0	0	0	0	0	0	0	0	0	0	0	0
05:30 PM	0	0	0	0	0	0	0	0	0	0	0	0
05:45 PM	0	0	0	0	0	0	0	0	0	0	0	0
<b>Total</b>	0	0	0	0	0	0	0	0	0	0	0	0
<b>Grand Total</b>	0	0	0	0	0	0	2	0	0	0	2	2
Apprch %	0	0		0	0		100	0				
Total %	0	0		0	0		100	0			100	

Start Time	Pleasant St From East			Vernon St From South			Pleasant St From West			Int. Total
	Left	Thru	App. Total	Left	Right	App. Total	Thru	Right	App. Total	
Peak Hour Analysis From 04:00 PM to 05:45 PM - Peak 1 of 1										
Peak Hour for Entire Intersection Begins at 04:00 PM										
04:00 PM	0	0	0	0	0	0	0	0	0	0
04:15 PM	0	0	0	0	0	0	0	0	0	0
04:30 PM	0	0	0	0	0	0	2	0	2	2
04:45 PM	0	0	0	0	0	0	0	0	0	0
<b>Total Volume</b>	0	0	0	0	0	0	2	0	2	2
<b>% App. Total</b>	0	0		0	0		100	0		
<b>PHF</b>	.000	.000	.000	.000	.000	.000	.250	.000	.250	.250

# Accurate Counts

978-664-2565

N/S Street : Vernon Street  
 E/W Street : Pleasant Street  
 City/State : Bridgewater, MA  
 Weather : Clear

File Name : 202700B5  
 Site Code : 20270005  
 Start Date : 10/2/2024  
 Page No : 11

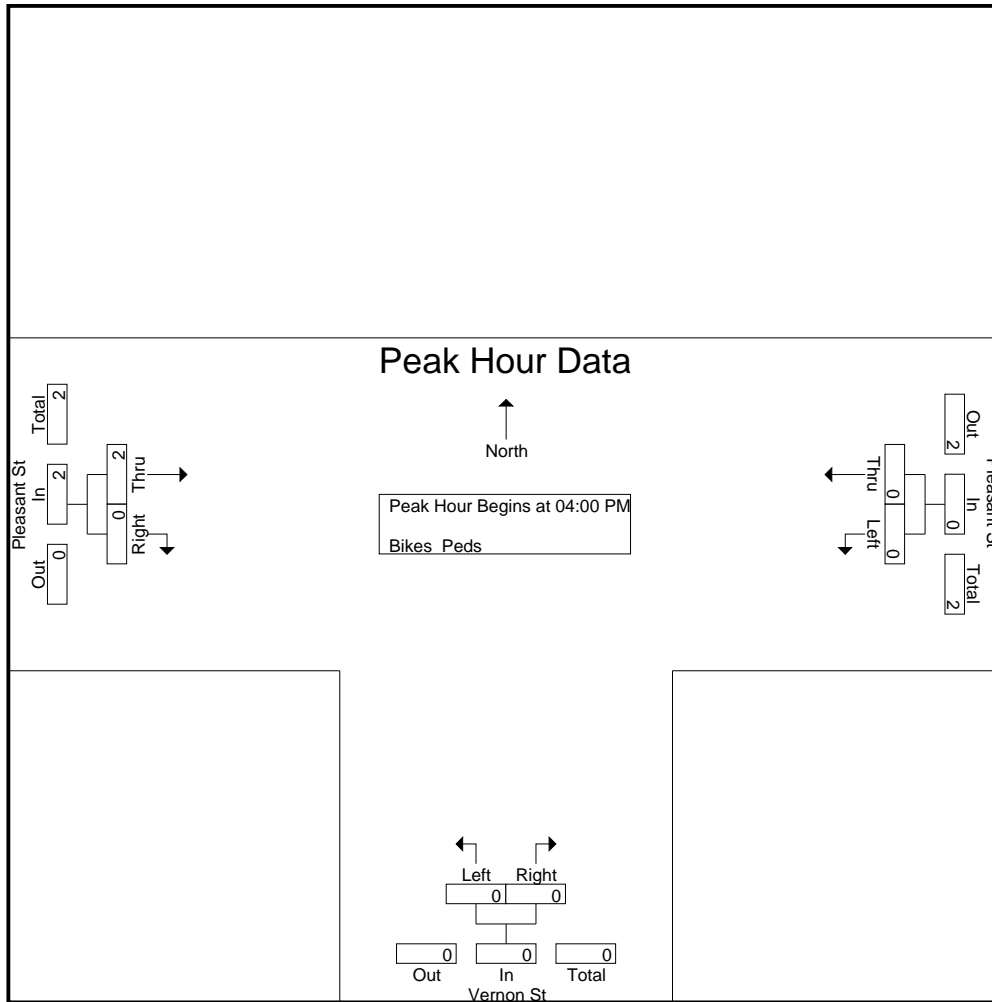

**Peak Hour Analysis From 04:00 PM to 05:45 PM - Peak 1 of 1**

Peak Hour for Each Approach Begins at:

	04:00 PM			04:00 PM			04:00 PM		
+0 mins.	0	0	0	0	0	0	0	0	0
+15 mins.	0	0	0	0	0	0	0	0	0
+30 mins.	0	0	0	0	0	0	2	0	2
+45 mins.	0	0	0	0	0	0	0	0	0
Total Volume	0	0	0	0	0	0	2	0	2
% App. Total	0	0	0	0	0	0	100	0	0
PHF	.000	.000	.000	.000	.000	.000	.250	.000	.250

# Accurate Counts

978-664-2565

File Name : 202700B5

Site Code : 20270005

Start Date : 10/2/2024

Page No : 12

N/S Street : Vernon Street

E/W Street : Pleasant Street

City/State : Bridgewater, MA

Weather : Clear

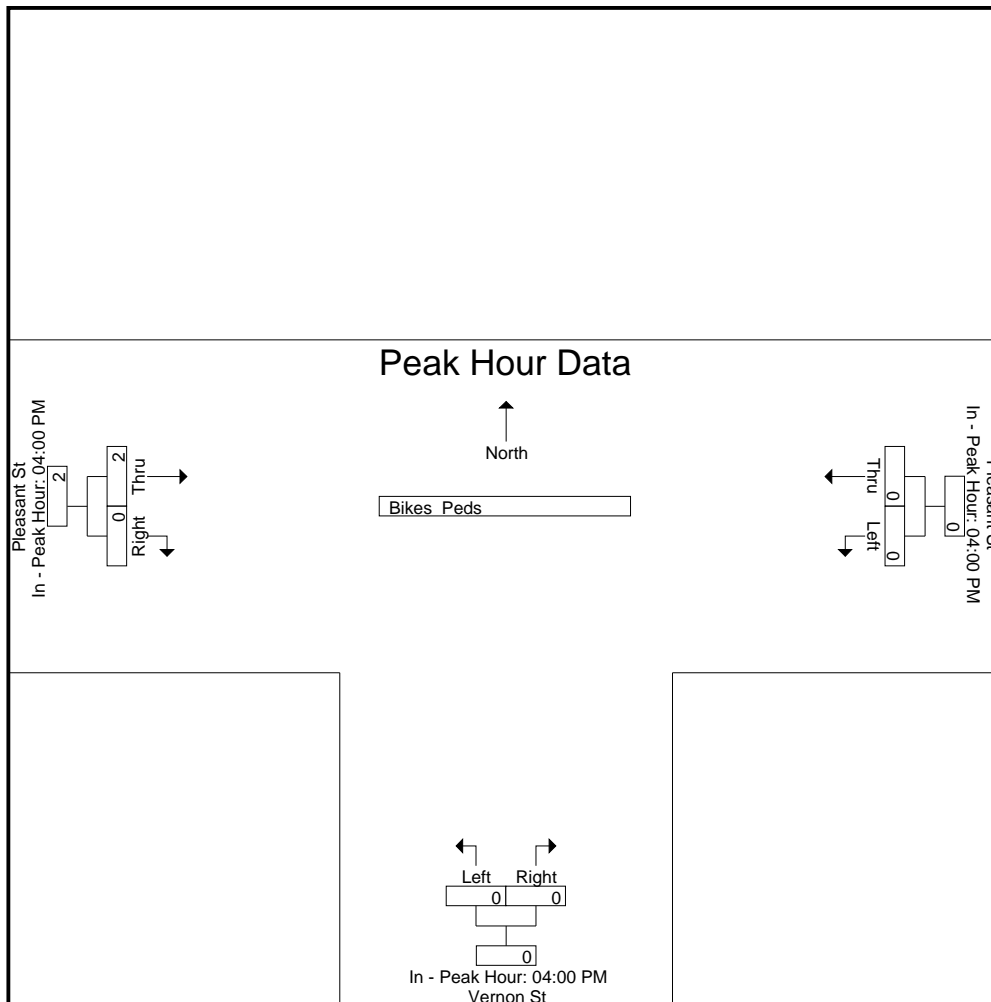



# Accurate Counts

978-664-2565

N/S Street : North Street  
 E/W Street : Pleasant Street  
 City/State : Bridgewater, MA  
 Weather : Clear

File Name : 202700B6  
 Site Code : 20270006  
 Start Date : 10/2/2024  
 Page No : 1

### Groups Printed- Cars - Trucks

Start Time	North St From North		Pleasant St From East		Pleasant St From West		Int. Total
	Left	Right	Thru	Right	Left	Thru	
07:00 AM	0	29	184	2	134	187	536
07:15 AM	0	59	246	1	49	201	556
07:30 AM	0	33	181	0	22	210	446
07:45 AM	1	19	192	0	35	224	471
<b>Total</b>	<b>1</b>	<b>140</b>	<b>803</b>	<b>3</b>	<b>240</b>	<b>822</b>	<b>2009</b>
08:00 AM	1	26	206	1	34	217	485
08:15 AM	0	24	199	1	31	219	474
08:30 AM	1	21	152	3	19	224	420
08:45 AM	2	19	149	0	18	177	365
<b>Total</b>	<b>4</b>	<b>90</b>	<b>706</b>	<b>5</b>	<b>102</b>	<b>837</b>	<b>1744</b>
<b>Grand Total</b>	<b>5</b>	<b>230</b>	<b>1509</b>	<b>8</b>	<b>342</b>	<b>1659</b>	<b>3753</b>
Apprch %	2.1	97.9	99.5	0.5	17.1	82.9	
Total %	0.1	6.1	40.2	0.2	9.1	44.2	
Cars	4	217	1468	8	330	1593	3620
% Cars	80	94.3	97.3	100	96.5	96	96.5
Trucks	1	13	41	0	12	66	133
% Trucks	20	5.7	2.7	0	3.5	4	3.5

Start Time	North St From North			Pleasant St From East			Pleasant St From West			Int. Total
	Left	Right	App. Total	Thru	Right	App. Total	Left	Thru	App. Total	
Peak Hour Analysis From 07:00 AM to 08:45 AM - Peak 1 of 1										
Peak Hour for Entire Intersection Begins at 07:00 AM										
07:00 AM	0	29	29	184	2	186	134	187	321	536
07:15 AM	0	59	59	246	1	247	49	201	250	556
07:30 AM	0	33	33	181	0	181	22	210	232	446
07:45 AM	1	19	20	192	0	192	35	224	259	471
<b>Total Volume</b>	<b>1</b>	<b>140</b>	<b>141</b>	<b>803</b>	<b>3</b>	<b>806</b>	<b>240</b>	<b>822</b>	<b>1062</b>	<b>2009</b>
% App. Total	0.7	99.3		99.6	0.4		22.6	77.4		
PHF	.250	.593	.597	.816	.375	.816	.448	.917	.827	.903
Cars	1	127	128	783	3	786	229	795	1024	1938
% Cars	100	90.7	90.8	97.5	100	97.5	95.4	96.7	96.4	96.5
Trucks	0	13	13	20	0	20	11	27	38	71
% Trucks	0	9.3	9.2	2.5	0	2.5	4.6	3.3	3.6	3.5

# Accurate Counts

978-664-2565

N/S Street : North Street  
 E/W Street : Pleasant Street  
 City/State : Bridgewater, MA  
 Weather : Clear

File Name : 202700B6  
 Site Code : 20270006  
 Start Date : 10/2/2024  
 Page No : 2

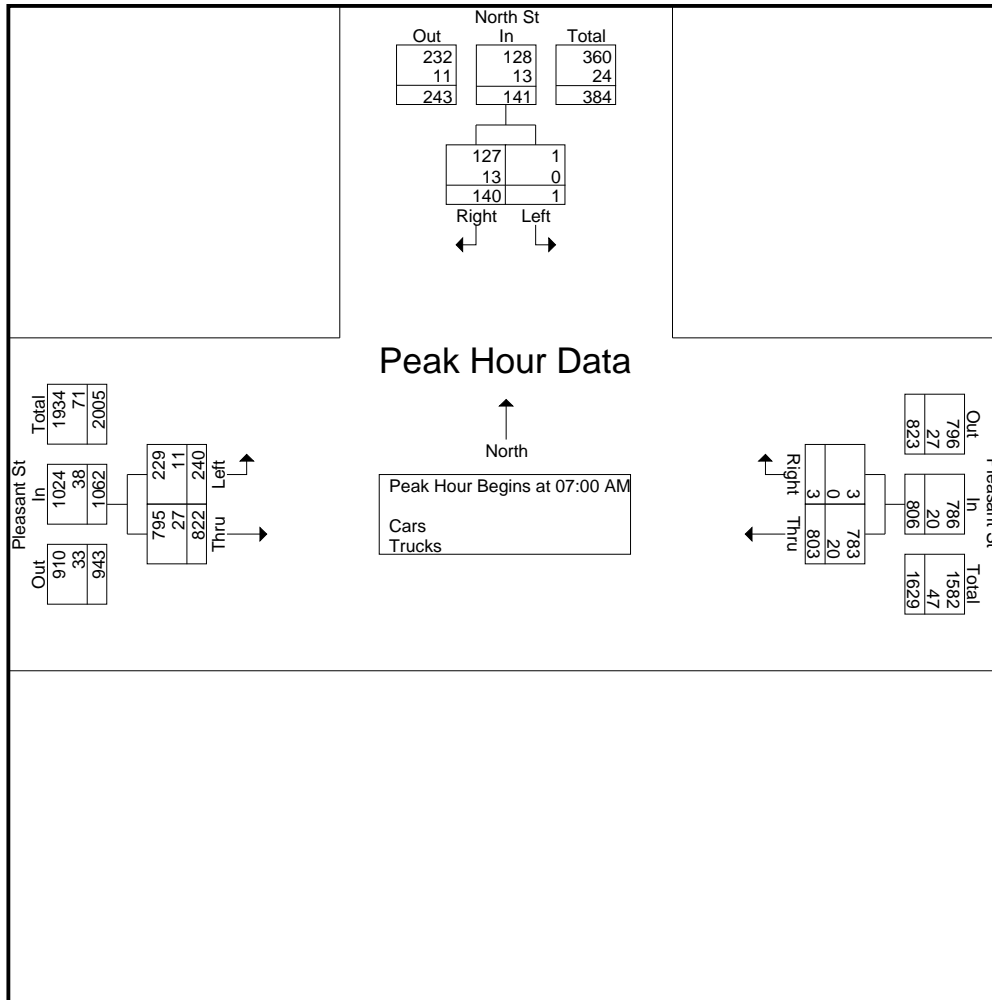

**Peak Hour Analysis From 07:00 AM to 08:45 AM - Peak 1 of 1**

Peak Hour for Each Approach Begins at:

	07:00 AM			07:15 AM			07:00 AM		
+0 mins.	0	29	29	<b>246</b>	<b>1</b>	<b>247</b>	<b>134</b>	187	<b>321</b>
+15 mins.	0	<b>59</b>	<b>59</b>	181	0	181	49	201	250
+30 mins.	0	33	33	192	0	192	22	210	232
+45 mins.	<b>1</b>	19	20	206	1	207	35	<b>224</b>	259
Total Volume	1	140	141	825	2	827	240	822	1062
% App. Total	0.7	99.3		99.8	0.2		22.6	77.4	
PHF	.250	.593	.597	.838	.500	.837	.448	.917	.827
Cars	1	127	128	809	2	811	229	795	1024
% Cars	100	90.7	90.8	98.1	100	98.1	95.4	96.7	96.4
Trucks	0	13	13	16	0	16	11	27	38
% Trucks	0	9.3	9.2	1.9	0	1.9	4.6	3.3	3.6

# Accurate Counts

978-664-2565

File Name : 202700B6

Site Code : 20270006

Start Date : 10/2/2024

Page No : 3

N/S Street : North Street  
 E/W Street : Pleasant Street  
 City/State : Bridgewater, MA  
 Weather : Clear

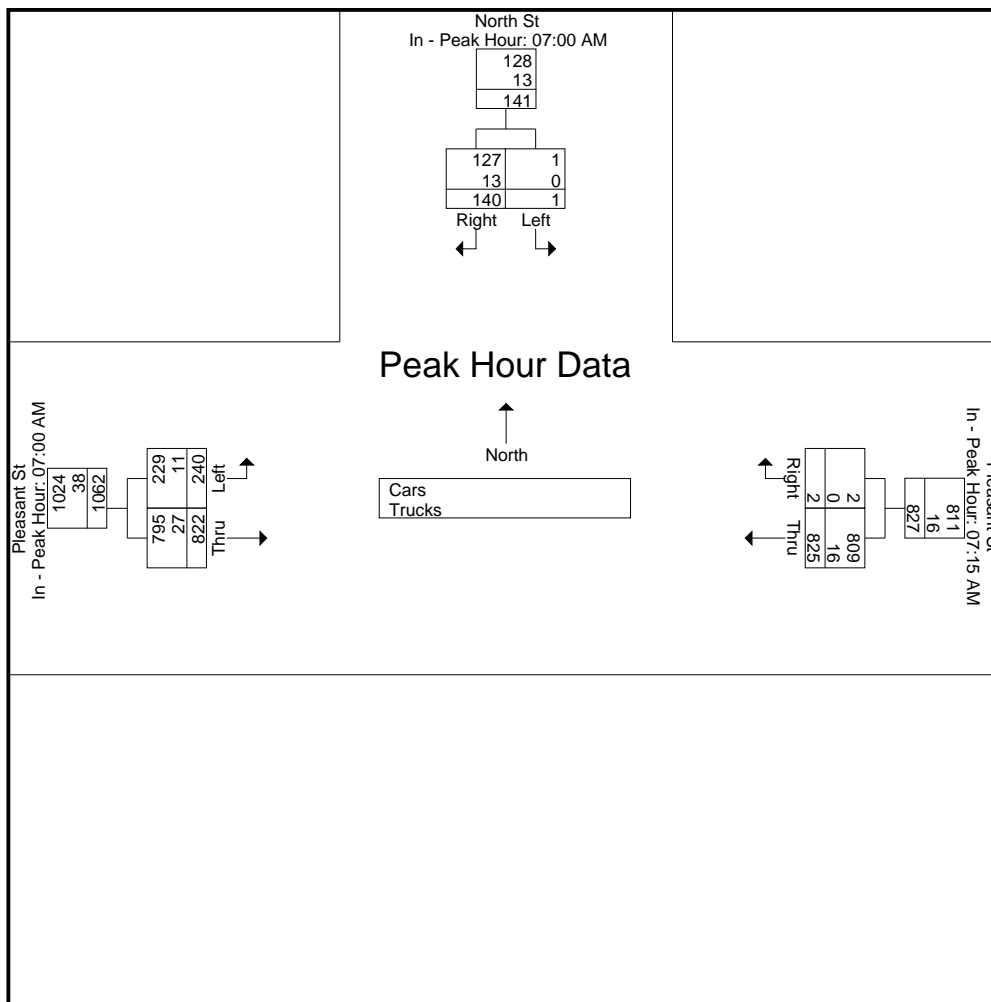

# Accurate Counts

978-664-2565

N/S Street : North Street  
 E/W Street : Pleasant Street  
 City/State : Bridgewater, MA  
 Weather : Clear

File Name : 202700B6  
 Site Code : 20270006  
 Start Date : 10/2/2024  
 Page No : 4

## Groups Printed- Cars

Start Time	North St From North		Pleasant St From East		Pleasant St From West		Int. Total
	Left	Right	Thru	Right	Left	Thru	
07:00 AM	0	25	176	2	126	180	509
07:15 AM	0	56	245	1	46	193	541
07:30 AM	0	30	176	0	22	203	431
07:45 AM	1	16	186	0	35	219	457
<b>Total</b>	<b>1</b>	<b>127</b>	<b>783</b>	<b>3</b>	<b>229</b>	<b>795</b>	<b>1938</b>
08:00 AM	1	26	202	1	34	204	468
08:15 AM	0	24	190	1	31	211	457
08:30 AM	1	21	145	3	19	214	403
08:45 AM	1	19	148	0	17	169	354
<b>Total</b>	<b>3</b>	<b>90</b>	<b>685</b>	<b>5</b>	<b>101</b>	<b>798</b>	<b>1682</b>
<b>Grand Total</b>	<b>4</b>	<b>217</b>	<b>1468</b>	<b>8</b>	<b>330</b>	<b>1593</b>	<b>3620</b>
Apprch %	1.8	98.2	99.5	0.5	17.2	82.8	
Total %	0.1	6	40.6	0.2	9.1	44	

Start Time	North St From North			Pleasant St From East			Pleasant St From West			Int. Total
	Left	Right	App. Total	Thru	Right	App. Total	Left	Thru	App. Total	
Peak Hour Analysis From 07:00 AM to 08:45 AM - Peak 1 of 1										
Peak Hour for Entire Intersection Begins at 07:00 AM										
07:00 AM	0	25	25	176	<b>2</b>	178	<b>126</b>	180	<b>306</b>	509
07:15 AM	0	<b>56</b>	<b>56</b>	<b>245</b>	1	<b>246</b>	46	193	239	<b>541</b>
07:30 AM	0	30	30	176	0	176	22	203	225	431
07:45 AM	1	16	17	186	0	186	35	<b>219</b>	254	457
<b>Total Volume</b>	1	127	128	783	3	786	229	795	1024	1938
% App. Total	0.8	99.2		99.6	0.4		22.4	77.6		
PHF	.250	.567	.571	.799	.375	.799	.454	.908	.837	.896

# Accurate Counts

978-664-2565

N/S Street : North Street  
 E/W Street : Pleasant Street  
 City/State : Bridgewater, MA  
 Weather : Clear

File Name : 202700B6  
 Site Code : 20270006  
 Start Date : 10/2/2024  
 Page No : 5

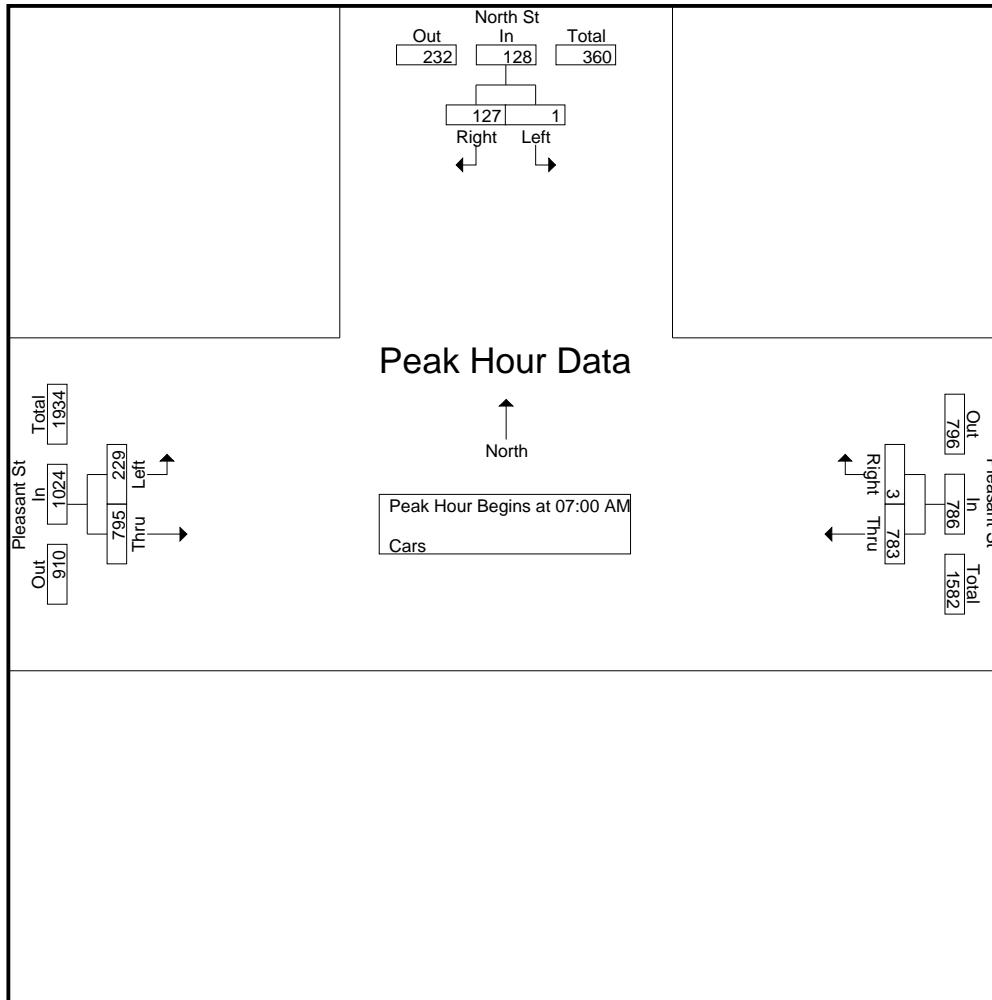

**Peak Hour Analysis From 07:00 AM to 08:45 AM - Peak 1 of 1**

Peak Hour for Each Approach Begins at:

	07:15 AM			07:15 AM			07:00 AM		
+0 mins.	0	<b>56</b>	<b>56</b>	<b>245</b>	<b>1</b>	<b>246</b>	<b>126</b>	180	<b>306</b>
+15 mins.	0	30	30	176	0	176	46	193	239
+30 mins.	<b>1</b>	16	17	186	0	186	22	203	225
+45 mins.	1	26	27	202	1	203	35	<b>219</b>	254
Total Volume	2	128	130	809	2	811	229	795	1024
% App. Total	1.5	98.5		99.8	0.2		22.4	77.6	
PHF	.500	.571	.580	.826	.500	.824	.454	.908	.837

# Accurate Counts

978-664-2565

File Name : 202700B6

Site Code : 20270006

Start Date : 10/2/2024

Page No : 6

N/S Street : North Street  
E/W Street : Pleasant Street  
City/State : Bridgewater, MA  
Weather : Clear

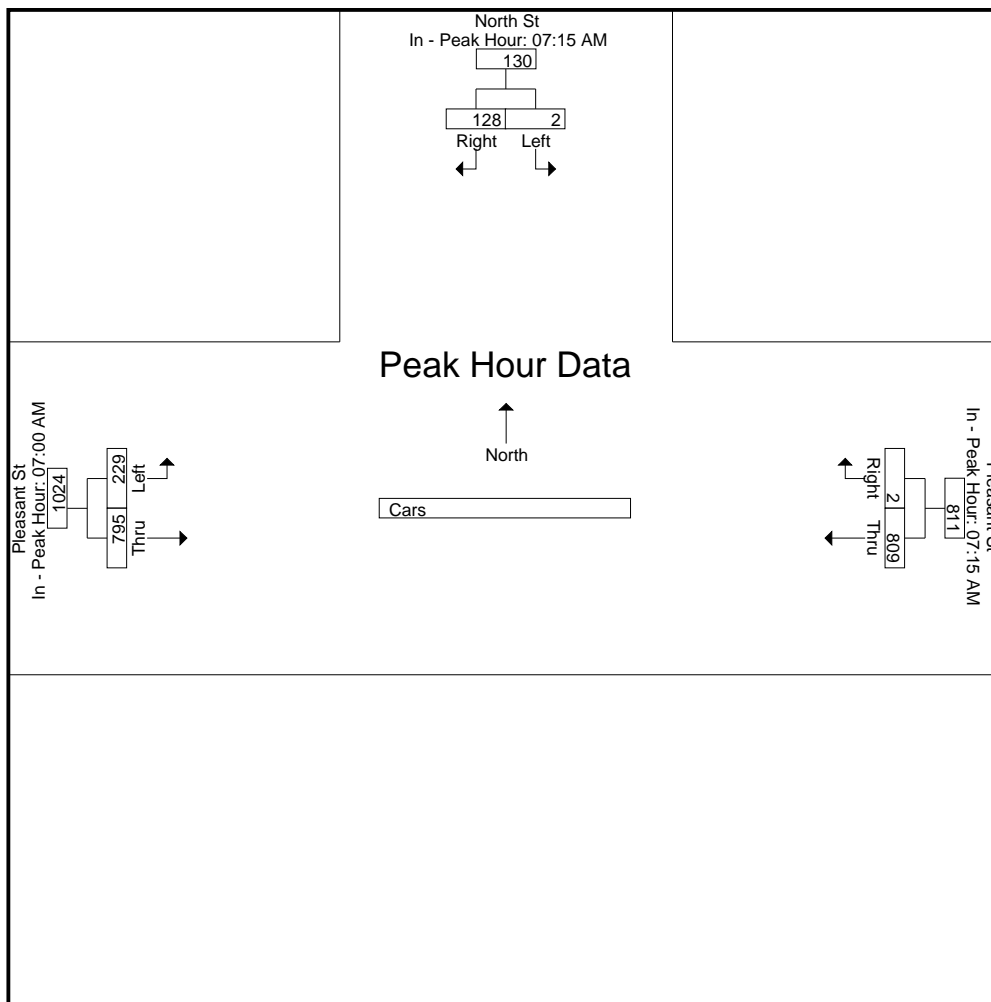

# Accurate Counts

978-664-2565

N/S Street : North Street  
 E/W Street : Pleasant Street  
 City/State : Bridgewater, MA  
 Weather : Clear

File Name : 202700B6  
 Site Code : 20270006  
 Start Date : 10/2/2024  
 Page No : 7

### Groups Printed- Trucks

Start Time	North St From North		Pleasant St From East		Pleasant St From West		Int. Total
	Left	Right	Thru	Right	Left	Thru	
07:00 AM	0	4	8	0	8	7	27
07:15 AM	0	3	1	0	3	8	15
07:30 AM	0	3	5	0	0	7	15
07:45 AM	0	3	6	0	0	5	14
<b>Total</b>	<b>0</b>	<b>13</b>	<b>20</b>	<b>0</b>	<b>11</b>	<b>27</b>	<b>71</b>
08:00 AM	0	0	4	0	0	13	17
08:15 AM	0	0	9	0	0	8	17
08:30 AM	0	0	7	0	0	10	17
08:45 AM	1	0	1	0	1	8	11
<b>Total</b>	<b>1</b>	<b>0</b>	<b>21</b>	<b>0</b>	<b>1</b>	<b>39</b>	<b>62</b>
<b>Grand Total</b>	<b>1</b>	<b>13</b>	<b>41</b>	<b>0</b>	<b>12</b>	<b>66</b>	<b>133</b>
Apprch %	7.1	92.9	100	0	15.4	84.6	
Total %	0.8	9.8	30.8	0	9	49.6	

Start Time	North St From North			Pleasant St From East			Pleasant St From West			Int. Total
	Left	Right	App. Total	Thru	Right	App. Total	Left	Thru	App. Total	
Peak Hour Analysis From 07:00 AM to 08:45 AM - Peak 1 of 1										
Peak Hour for Entire Intersection Begins at 07:00 AM										
07:00 AM	0	4	4	8	0	8	8	7	15	27
07:15 AM	0	3	3	1	0	1	3	8	11	15
07:30 AM	0	3	3	5	0	5	0	7	7	15
07:45 AM	0	3	3	6	0	6	0	5	5	14
<b>Total Volume</b>	<b>0</b>	<b>13</b>	<b>13</b>	<b>20</b>	<b>0</b>	<b>20</b>	<b>11</b>	<b>27</b>	<b>38</b>	<b>71</b>
% App. Total	0	100		100	0		28.9	71.1		
PHF	.000	.813	.813	.625	.000	.625	.344	.844	.633	.657

# Accurate Counts

978-664-2565

N/S Street : North Street  
 E/W Street : Pleasant Street  
 City/State : Bridgewater, MA  
 Weather : Clear

File Name : 202700B6  
 Site Code : 20270006  
 Start Date : 10/2/2024  
 Page No : 8

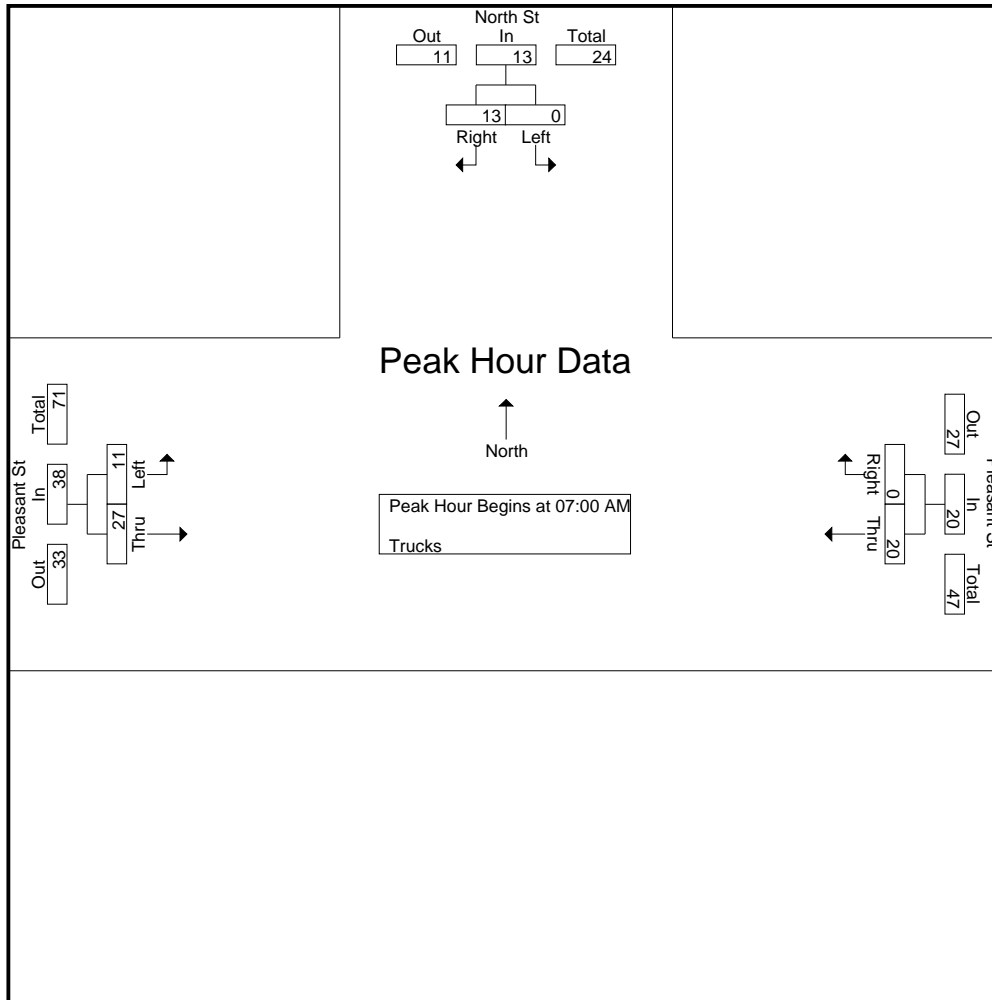

**Peak Hour Analysis From 07:00 AM to 08:45 AM - Peak 1 of 1**

Peak Hour for Each Approach Begins at:

	07:00 AM			07:45 AM			08:00 AM		
+0 mins.	0	4	4	6	0	6	0	13	13
+15 mins.	0	3	3	4	0	4	0	8	8
+30 mins.	0	3	3	9	0	9	0	10	10
+45 mins.	0	3	3	7	0	7	1	8	9
Total Volume	0	13	13	26	0	26	1	39	40
% App. Total	0	100		100	0		2.5	97.5	
PHF	.000	.813	.813	.722	.000	.722	.250	.750	.769



# Accurate Counts

978-664-2565

File Name : 202700B6

Site Code : 20270006

Start Date : 10/2/2024

Page No : 9

N/S Street : North Street  
E/W Street : Pleasant Street  
City/State : Bridgewater, MA  
Weather : Clear

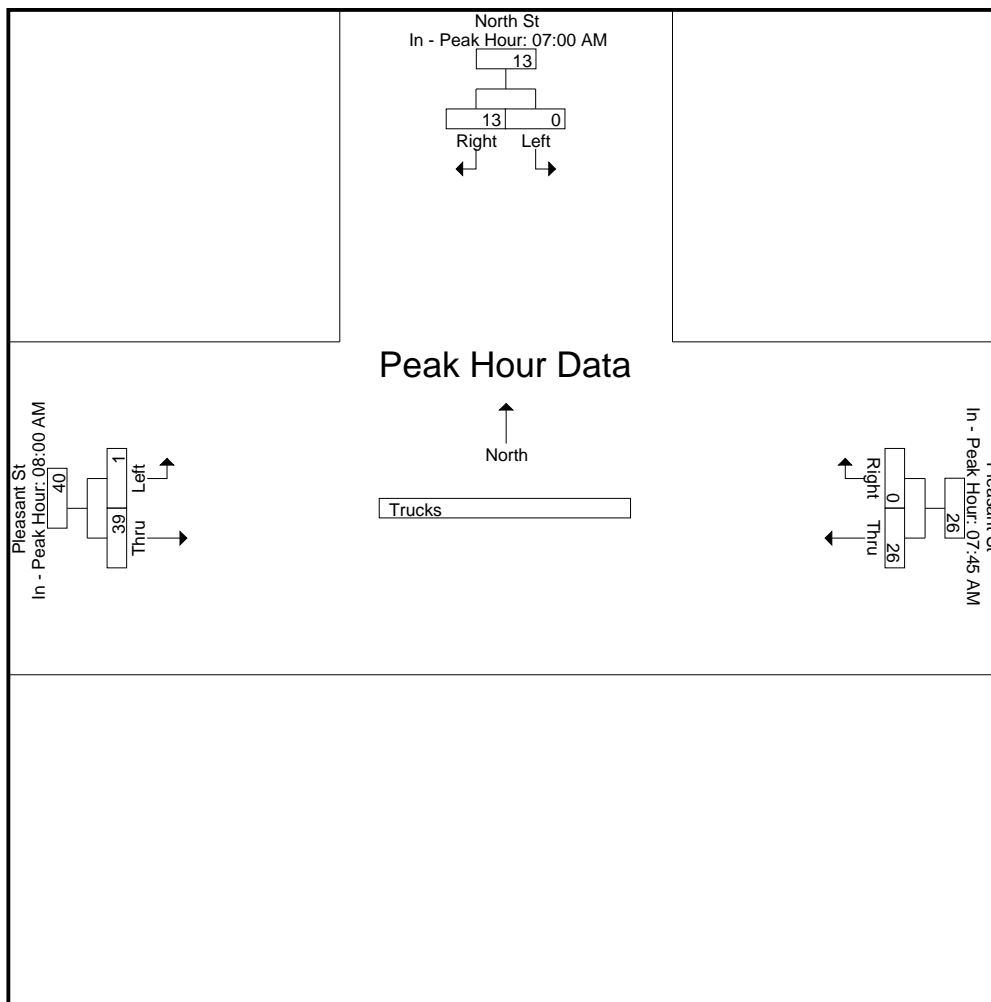

# Accurate Counts

978-664-2565

N/S Street : North Street  
 E/W Street : Pleasant Street  
 City/State : Bridgewater, MA  
 Weather : Clear

File Name : 202700B6  
 Site Code : 20270006  
 Start Date : 10/2/2024  
 Page No : 10

### Groups Printed- Bikes Peds

Start Time	North St From North			Pleasant St From East			Pleasant St From West			Exclu. Total	Inclu. Total	Int. Total
	Left	Right	Peds	Thru	Right	Peds	Left	Thru	Peds			
07:00 AM	0	0	0	0	0	0	0	0	0	0	0	0
07:15 AM	0	0	0	0	0	0	0	0	0	0	0	0
07:30 AM	0	0	0	0	0	0	0	0	0	0	0	0
07:45 AM	0	0	0	0	0	0	0	1	0	0	1	1
<b>Total</b>	0	0	0	0	0	0	0	1	0	0	1	1
08:00 AM	0	0	0	0	0	0	0	0	0	0	0	0
08:15 AM	0	0	0	0	0	0	0	0	0	0	0	0
08:30 AM	0	0	1	0	0	0	0	0	0	1	0	1
08:45 AM	0	0	0	0	0	0	0	0	0	0	0	0
<b>Total</b>	0	0	1	0	0	0	0	0	0	1	0	1
<b>Grand Total</b>	0	0	1	0	0	0	0	1	0	1	1	2
Apprch %	0	0		0	0		0	100				
Total %	0	0		0	0		0	100		50	50	

Start Time	North St From North			Pleasant St From East			Pleasant St From West			Int. Total
	Left	Right	App. Total	Thru	Right	App. Total	Left	Thru	App. Total	
Peak Hour Analysis From 07:00 AM to 08:45 AM - Peak 1 of 1										
Peak Hour for Entire Intersection Begins at 07:00 AM										
07:00 AM	0	0	0	0	0	0	0	0	0	0
07:15 AM	0	0	0	0	0	0	0	0	0	0
07:30 AM	0	0	0	0	0	0	0	0	0	0
07:45 AM	0	0	0	0	0	0	0	1	1	1
<b>Total Volume</b>	0	0	0	0	0	0	0	1	1	1
<b>% App. Total</b>	0	0		0	0		0	100		
<b>PHF</b>	.000	.000	.000	.000	.000	.000	.000	.250	.250	.250

# Accurate Counts

978-664-2565

File Name : 202700B6

Site Code : 20270006

Start Date : 10/2/2024

Page No : 11

N/S Street : North Street  
 E/W Street : Pleasant Street  
 City/State : Bridgewater, MA  
 Weather : Clear

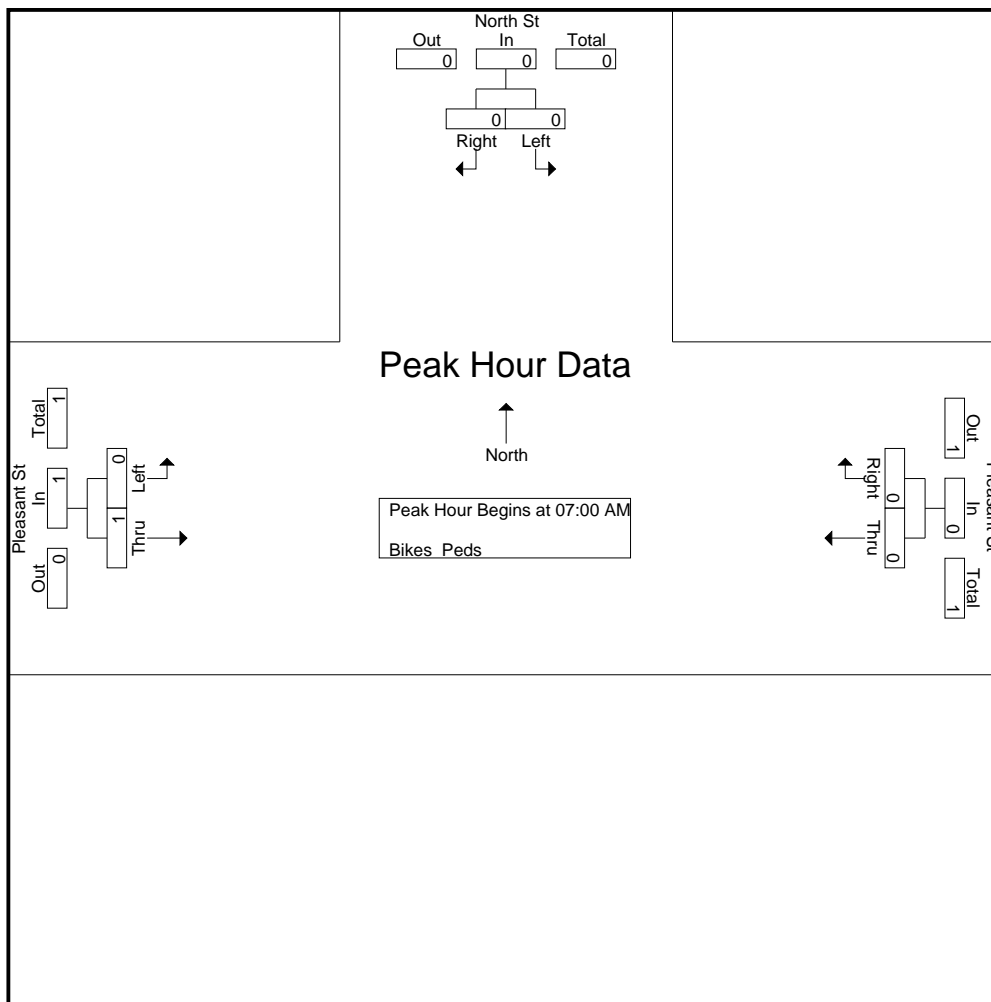

**Peak Hour Analysis From 07:00 AM to 08:45 AM - Peak 1 of 1**

Peak Hour for Each Approach Begins at:

	07:00 AM			07:00 AM			07:00 AM		
+0 mins.	0	0	0	0	0	0	0	0	0
+15 mins.	0	0	0	0	0	0	0	0	0
+30 mins.	0	0	0	0	0	0	0	0	0
+45 mins.	0	0	0	0	0	0	0	1	1
Total Volume	0	0	0	0	0	0	0	1	1
% App. Total	0	0	0	0	0	0	0	100	100
PHF	.000	.000	.000	.000	.000	.000	.000	.250	.250

# Accurate Counts

978-664-2565

File Name : 202700B6

Site Code : 20270006

Start Date : 10/2/2024

Page No : 12

N/S Street : North Street  
E/W Street : Pleasant Street  
City/State : Bridgewater, MA  
Weather : Clear

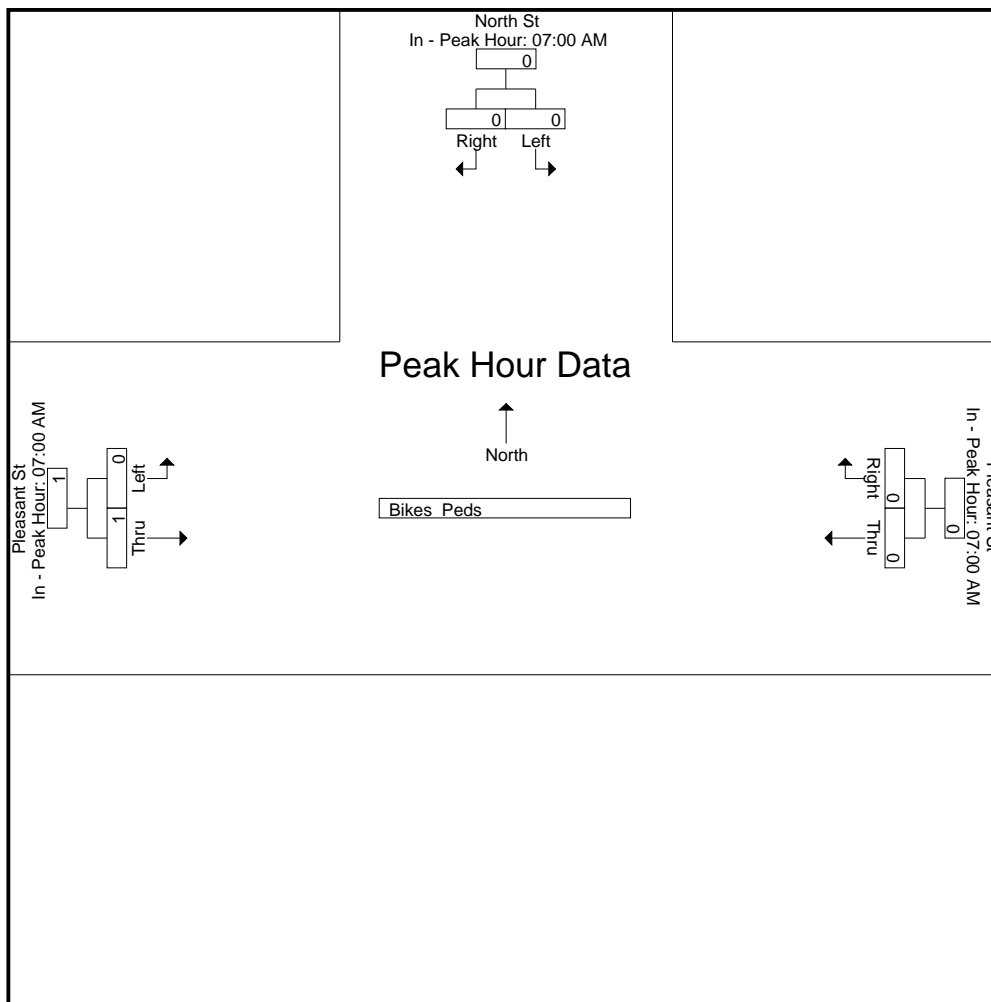

# Accurate Counts

978-664-2565

N/S Street : North Street  
 E/W Street : Pleasant Street  
 City/State : Bridgewater, MA  
 Weather : Clear

File Name : 202700B6  
 Site Code : 20270006  
 Start Date : 10/2/2024  
 Page No : 1

### Groups Printed- Cars - Trucks

Start Time	North St From North		Pleasant St From East		Pleasant St From West		Int. Total
	Left	Right	Thru	Right	Left	Thru	
04:00 PM	1	31	223	1	29	205	490
04:15 PM	1	30	222	1	24	219	497
04:30 PM	0	27	228	1	23	205	484
04:45 PM	1	59	195	0	26	201	482
<b>Total</b>	<b>3</b>	<b>147</b>	<b>868</b>	<b>3</b>	<b>102</b>	<b>830</b>	<b>1953</b>
05:00 PM	0	52	223	0	28	228	531
05:15 PM	0	53	210	0	25	238	526
05:30 PM	1	23	210	0	25	216	475
05:45 PM	1	30	167	2	22	214	436
<b>Total</b>	<b>2</b>	<b>158</b>	<b>810</b>	<b>2</b>	<b>100</b>	<b>896</b>	<b>1968</b>
<b>Grand Total</b>	<b>5</b>	<b>305</b>	<b>1678</b>	<b>5</b>	<b>202</b>	<b>1726</b>	<b>3921</b>
Apprch %	1.6	98.4	99.7	0.3	10.5	89.5	
Total %	0.1	7.8	42.8	0.1	5.2	44	
Cars	5	305	1664	5	202	1695	3876
% Cars	100	100	99.2	100	100	98.2	98.9
Trucks	0	0	14	0	0	31	45
% Trucks	0	0	0.8	0	0	1.8	1.1

Start Time	North St From North			Pleasant St From East			Pleasant St From West			Int. Total
	Left	Right	App. Total	Thru	Right	App. Total	Left	Thru	App. Total	
Peak Hour Analysis From 04:00 PM to 05:45 PM - Peak 1 of 1										
Peak Hour for Entire Intersection Begins at 04:30 PM										
04:30 PM	0	27	27	<b>228</b>	<b>1</b>	<b>229</b>	23	205	228	484
04:45 PM	1	59	60	195	0	195	26	201	227	482
05:00 PM	0	52	52	223	0	223	<b>28</b>	228	256	<b>531</b>
05:15 PM	0	53	53	210	0	210	25	<b>238</b>	<b>263</b>	526
<b>Total Volume</b>	1	191	192	856	1	857	102	872	974	2023
% App. Total	0.5	99.5		99.9	0.1		10.5	89.5		
PHF	.250	.809	.800	.939	.250	.936	.911	.916	.926	.952
Cars	1	191	192	849	1	850	102	856	958	2000
% Cars	100	100	100	99.2	100	99.2	100	98.2	98.4	98.9
Trucks	0	0	0	7	0	7	0	16	16	23
% Trucks	0	0	0	0.8	0	0.8	0	1.8	1.6	1.1

# Accurate Counts

978-664-2565

N/S Street : North Street  
 E/W Street : Pleasant Street  
 City/State : Bridgewater, MA  
 Weather : Clear

File Name : 202700B6  
 Site Code : 20270006  
 Start Date : 10/2/2024  
 Page No : 2

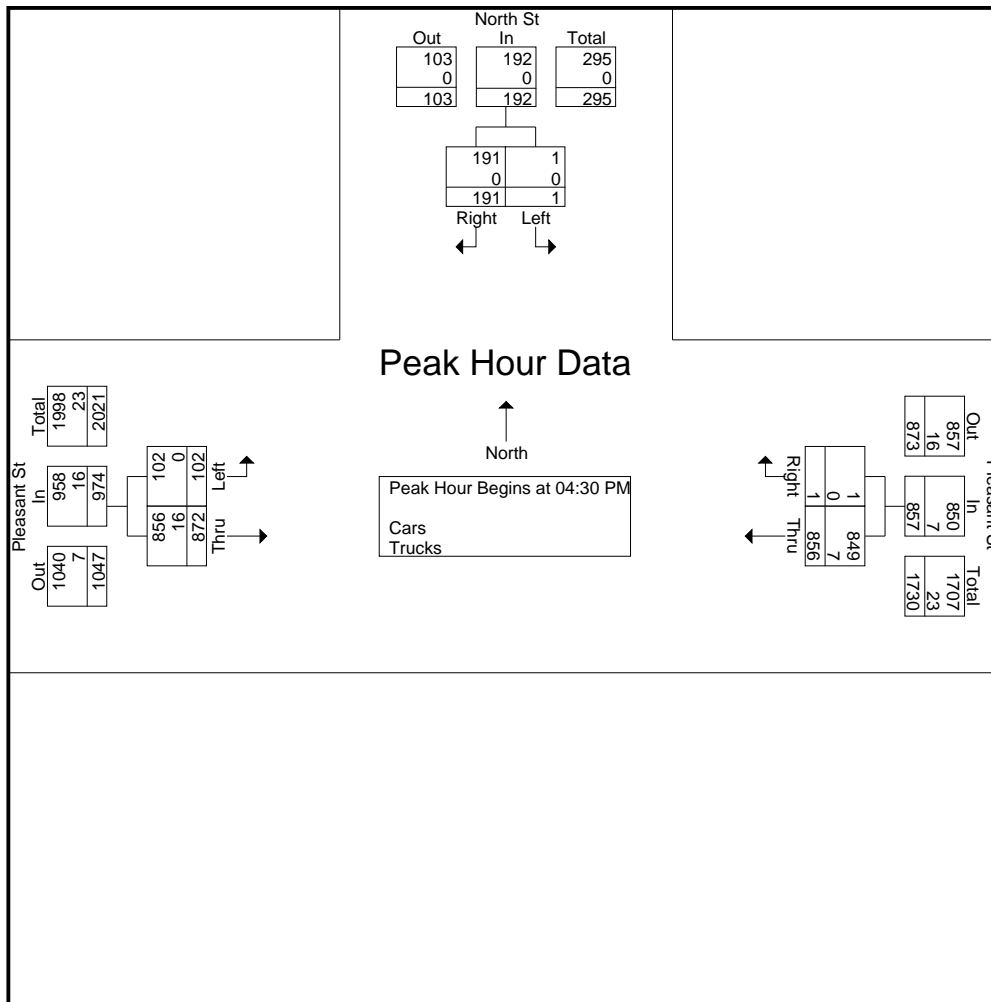

**Peak Hour Analysis From 04:00 PM to 05:45 PM - Peak 1 of 1**

Peak Hour for Each Approach Begins at:

	04:30 PM			04:00 PM			05:00 PM		
+0 mins.	0	27	27	223	1	224	28	228	256
+15 mins.	1	59	60	222	1	223	25	238	263
+30 mins.	0	52	52	228	1	229	25	216	241
+45 mins.	0	53	53	195	0	195	22	214	236
<b>Total Volume</b>	1	191	192	868	3	871	100	896	996
<b>% App. Total</b>	0.5	99.5		99.7	0.3		10	90	
PHF	.250	.809	.800	.952	.750	.951	.893	.941	.947
Cars	1	191	192	857	3	860	100	887	987
% Cars	100	100	100	98.7	100	98.7	100	99	99.1
Trucks	0	0	0	11	0	11	0	9	9
% Trucks	0	0	0	1.3	0	1.3	0	1	0.9

# Accurate Counts

978-664-2565

File Name : 202700B6

Site Code : 20270006

Start Date : 10/2/2024

Page No : 3

N/S Street : North Street  
 E/W Street : Pleasant Street  
 City/State : Bridgewater, MA  
 Weather : Clear

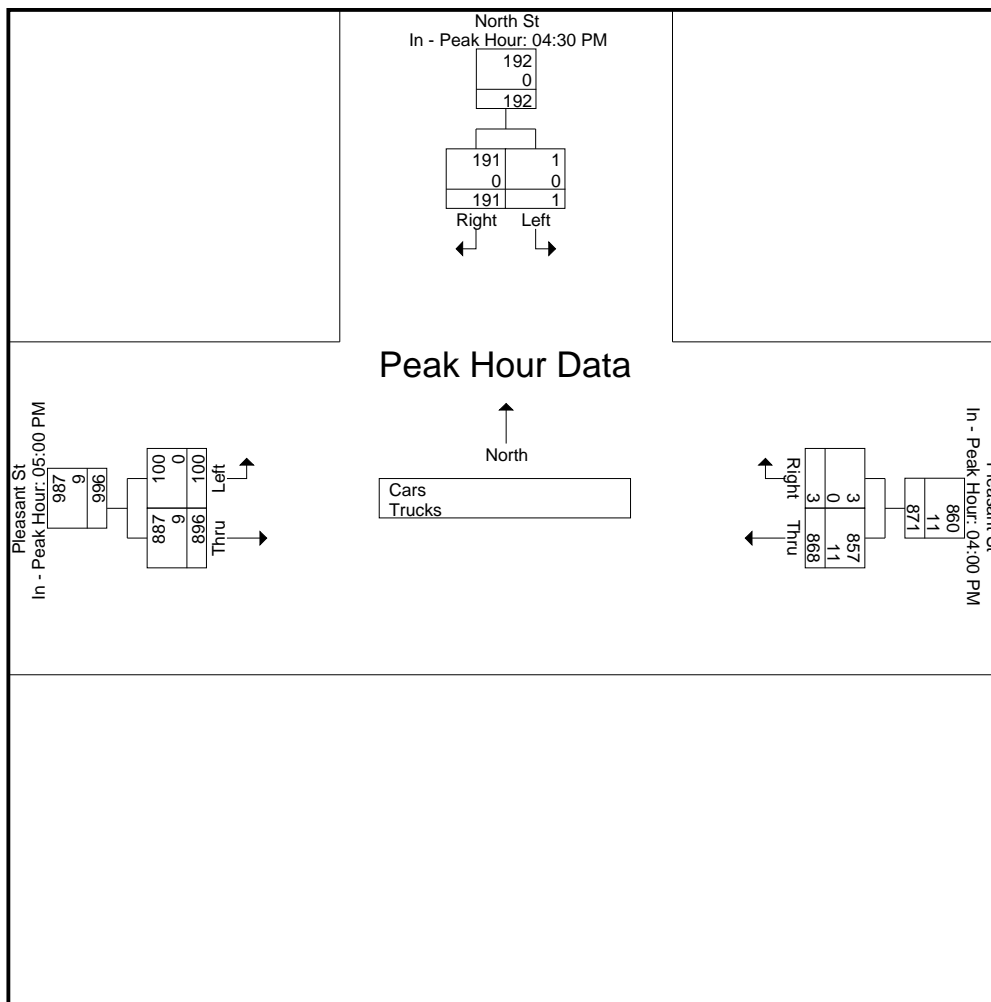

# Accurate Counts

978-664-2565

N/S Street : North Street  
 E/W Street : Pleasant Street  
 City/State : Bridgewater, MA  
 Weather : Clear

File Name : 202700B6  
 Site Code : 20270006  
 Start Date : 10/2/2024  
 Page No : 4

## Groups Printed- Cars

Start Time	North St From North		Pleasant St From East		Pleasant St From West		Int. Total
	Left	Right	Thru	Right	Left	Thru	
04:00 PM	1	31	220	1	29	201	483
04:15 PM	1	30	218	1	24	211	485
04:30 PM	0	27	227	1	23	198	476
04:45 PM	1	59	192	0	26	198	476
<b>Total</b>	<b>3</b>	<b>147</b>	<b>857</b>	<b>3</b>	<b>102</b>	<b>808</b>	<b>1920</b>
05:00 PM	0	52	221	0	28	225	526
05:15 PM	0	53	209	0	25	235	522
05:30 PM	1	23	210	0	25	215	474
05:45 PM	1	30	167	2	22	212	434
<b>Total</b>	<b>2</b>	<b>158</b>	<b>807</b>	<b>2</b>	<b>100</b>	<b>887</b>	<b>1956</b>
<b>Grand Total</b>	<b>5</b>	<b>305</b>	<b>1664</b>	<b>5</b>	<b>202</b>	<b>1695</b>	<b>3876</b>
Apprch %	1.6	98.4	99.7	0.3	10.6	89.4	
Total %	0.1	7.9	42.9	0.1	5.2	43.7	

Start Time	North St From North			Pleasant St From East			Pleasant St From West			Int. Total
	Left	Right	App. Total	Thru	Right	App. Total	Left	Thru	App. Total	
Peak Hour Analysis From 04:00 PM to 05:45 PM - Peak 1 of 1										
Peak Hour for Entire Intersection Begins at 04:30 PM										
04:30 PM	0	27	27	<b>227</b>	<b>1</b>	<b>228</b>	23	198	221	476
04:45 PM	<b>1</b>	<b>59</b>	<b>60</b>	192	0	192	26	198	224	476
05:00 PM	0	52	52	221	0	221	<b>28</b>	225	253	<b>526</b>
05:15 PM	0	53	53	209	0	209	25	<b>235</b>	<b>260</b>	522
Total Volume	1	191	192	849	1	850	102	856	958	2000
% App. Total	0.5	99.5		99.9	0.1		10.6	89.4		
PHF	.250	.809	.800	.935	.250	.932	.911	.911	.921	.951



# Accurate Counts

978-664-2565

N/S Street : North Street  
 E/W Street : Pleasant Street  
 City/State : Bridgewater, MA  
 Weather : Clear

File Name : 202700B6  
 Site Code : 20270006  
 Start Date : 10/2/2024  
 Page No : 5

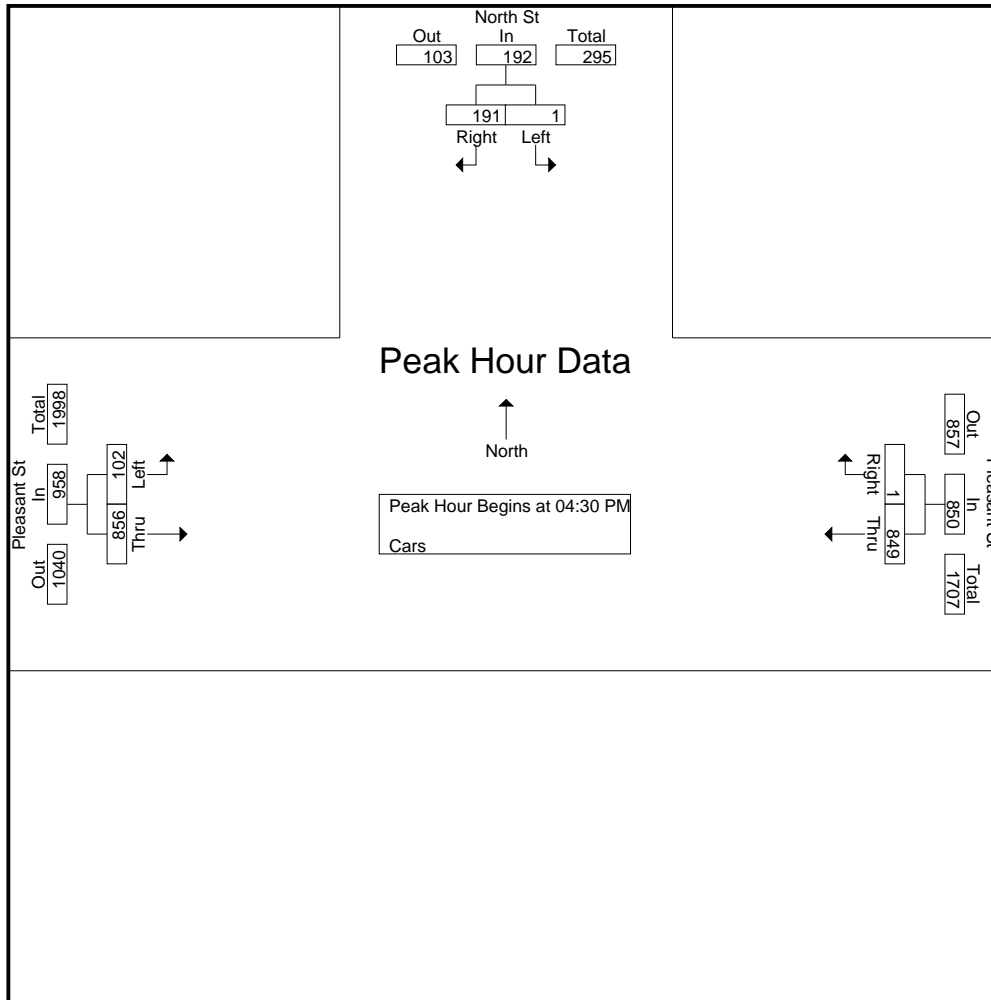

**Peak Hour Analysis From 04:00 PM to 05:45 PM - Peak 1 of 1**

Peak Hour for Each Approach Begins at:

	04:30 PM			04:00 PM			05:00 PM		
+0 mins.	0	27	27	220	1	221	28	225	253
+15 mins.	1	59	60	218	1	219	25	235	260
+30 mins.	0	52	52	227	1	228	25	215	240
+45 mins.	0	53	53	192	0	192	22	212	234
<b>Total Volume</b>	1	191	192	857	3	860	100	887	987
<b>% App. Total</b>	0.5	99.5		99.7	0.3		10.1	89.9	
<b>PHF</b>	.250	.809	.800	.944	.750	.943	.893	.944	.949

# Accurate Counts

978-664-2565

File Name : 202700B6

Site Code : 20270006

Start Date : 10/2/2024

Page No : 6

N/S Street : North Street  
E/W Street : Pleasant Street  
City/State : Bridgewater, MA  
Weather : Clear

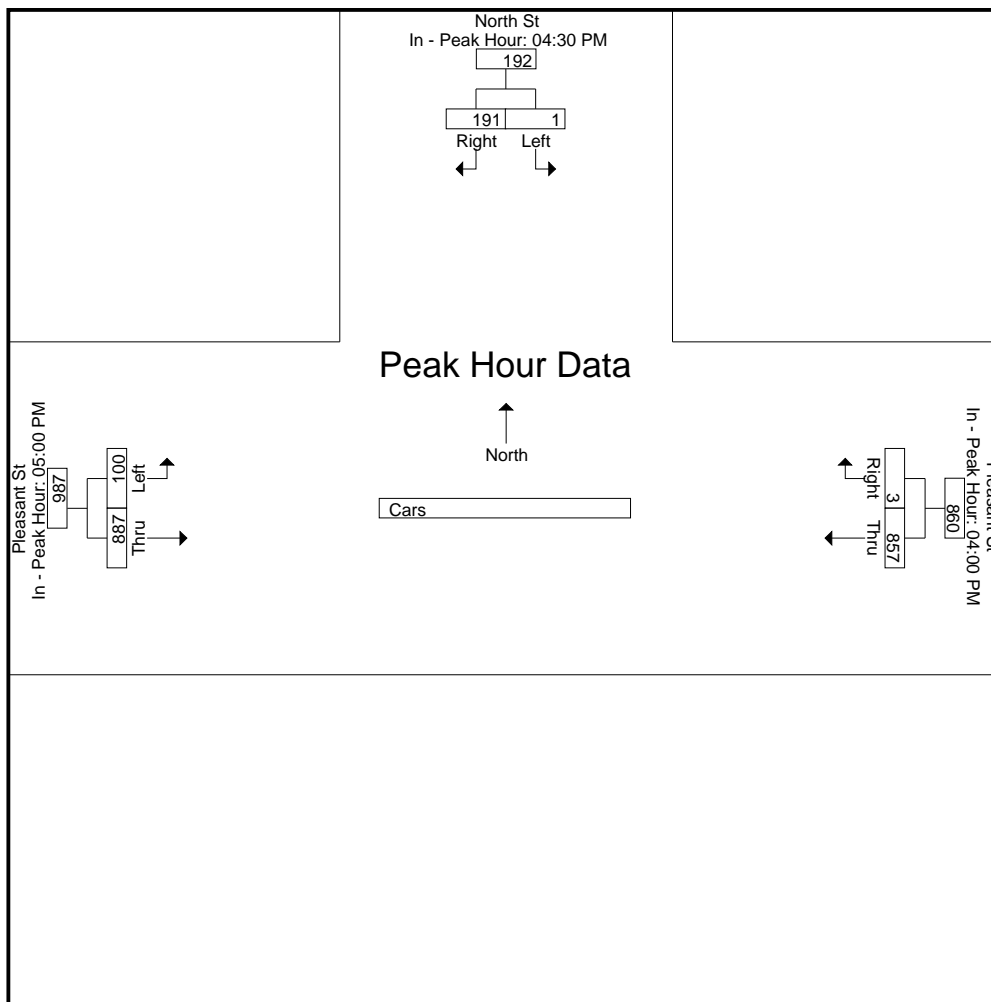

# Accurate Counts

978-664-2565

N/S Street : North Street  
 E/W Street : Pleasant Street  
 City/State : Bridgewater, MA  
 Weather : Clear

File Name : 202700B6  
 Site Code : 20270006  
 Start Date : 10/2/2024  
 Page No : 7

### Groups Printed- Trucks

Start Time	North St From North		Pleasant St From East		Pleasant St From West		Int. Total
	Left	Right	Thru	Right	Left	Thru	
04:00 PM	0	0	3	0	0	4	7
04:15 PM	0	0	4	0	0	8	12
04:30 PM	0	0	1	0	0	7	8
04:45 PM	0	0	3	0	0	3	6
<b>Total</b>	0	0	11	0	0	22	33
05:00 PM	0	0	2	0	0	3	5
05:15 PM	0	0	1	0	0	3	4
05:30 PM	0	0	0	0	0	1	1
05:45 PM	0	0	0	0	0	2	2
<b>Total</b>	0	0	3	0	0	9	12
<b>Grand Total</b>	0	0	14	0	0	31	45
Apprch %	0	0	100	0	0	100	
Total %	0	0	31.1	0	0	68.9	

Start Time	North St From North			Pleasant St From East			Pleasant St From West			Int. Total
	Left	Right	App. Total	Thru	Right	App. Total	Left	Thru	App. Total	
Peak Hour Analysis From 04:00 PM to 05:45 PM - Peak 1 of 1										
Peak Hour for Entire Intersection Begins at 04:00 PM										
04:00 PM	0	0	0	3	0	3	0	4	4	7
04:15 PM	0	0	0	4	0	4	0	8	8	12
04:30 PM	0	0	0	1	0	1	0	7	7	8
04:45 PM	0	0	0	3	0	3	0	3	3	6
<b>Total Volume</b>	0	0	0	11	0	11	0	22	22	33
<b>% App. Total</b>	0	0		100	0		0	100		
<b>PHF</b>	.000	.000	.000	.688	.000	.688	.000	.688	.688	.688

# Accurate Counts

978-664-2565

File Name : 202700B6

Site Code : 20270006

Start Date : 10/2/2024

Page No : 8

N/S Street : North Street  
 E/W Street : Pleasant Street  
 City/State : Bridgewater, MA  
 Weather : Clear

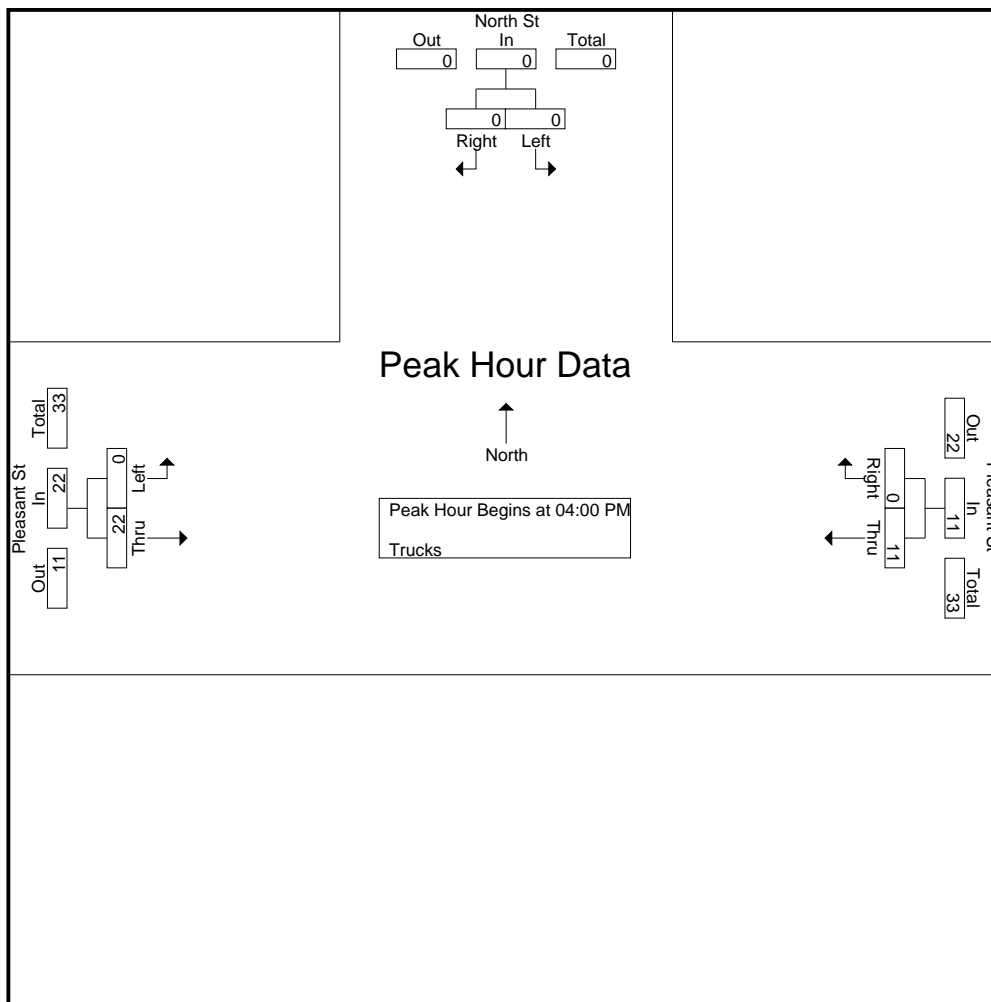

Peak Hour Analysis From 04:00 PM to 05:45 PM - Peak 1 of 1

Peak Hour for Each Approach Begins at:

	04:00 PM			04:00 PM			04:00 PM		
+0 mins.	0	0	0	3	0	3	0	4	4
+15 mins.	0	0	0	4	0	4	0	8	8
+30 mins.	0	0	0	1	0	1	0	7	7
+45 mins.	0	0	0	3	0	3	0	3	3
Total Volume	0	0	0	11	0	11	0	22	22
% App. Total	0	0	0	100	0	100	0	100	100
PHF	.000	.000	.000	.688	.000	.688	.000	.688	.688

# Accurate Counts

978-664-2565

File Name : 202700B6

Site Code : 20270006

Start Date : 10/2/2024

Page No : 9

N/S Street : North Street

E/W Street : Pleasant Street

City/State : Bridgewater, MA

Weather : Clear

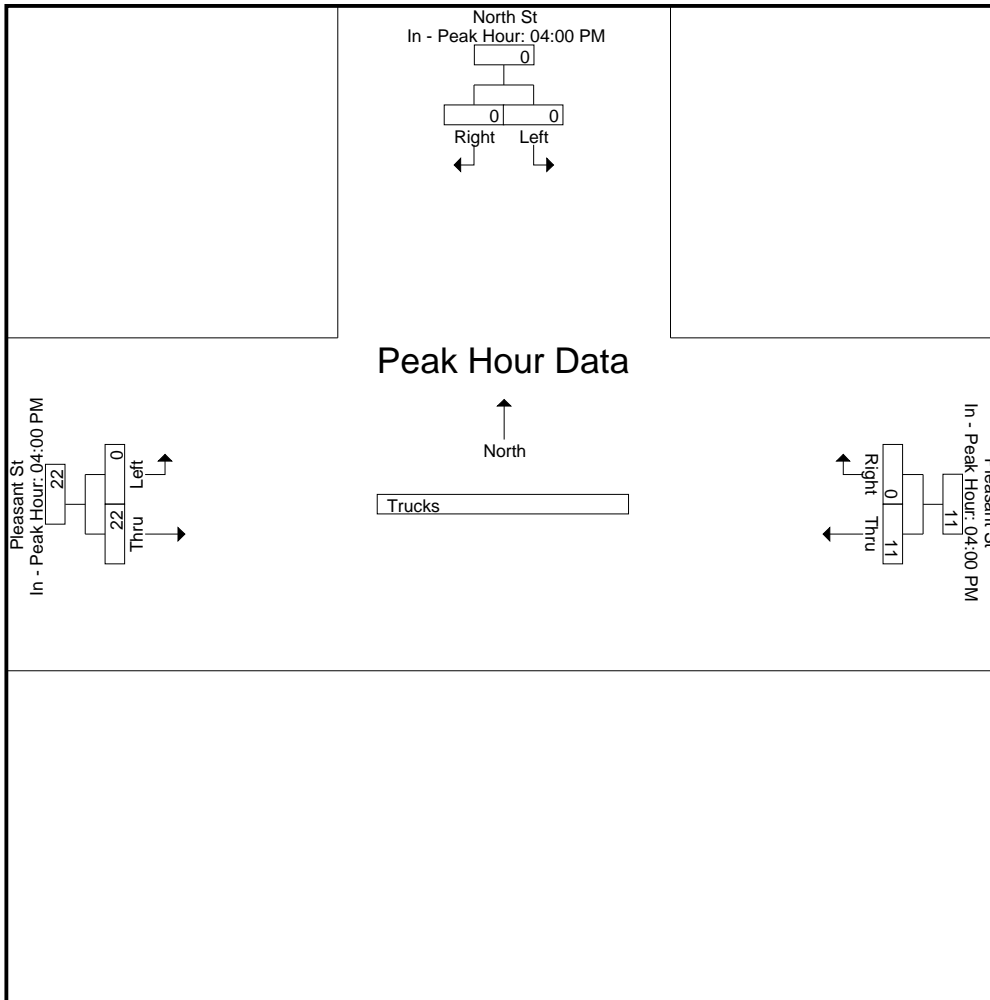

# Accurate Counts

978-664-2565

N/S Street : North Street  
 E/W Street : Pleasant Street  
 City/State : Bridgewater, MA  
 Weather : Clear

File Name : 202700B6  
 Site Code : 20270006  
 Start Date : 10/2/2024  
 Page No : 10

### Groups Printed- Bikes Peds

Start Time	North St From North			Pleasant St From East			Pleasant St From West			Exclu. Total	Inclu. Total	Int. Total
	Left	Right	Peds	Thru	Right	Peds	Left	Thru	Peds			
04:00 PM	0	0	0	0	0	0	0	0	0	0	0	0
04:15 PM	0	0	0	0	0	0	0	0	0	0	0	0
04:30 PM	0	0	3	0	0	0	0	2	0	3	2	5
04:45 PM	0	0	0	0	0	0	0	0	0	0	0	0
<b>Total</b>	0	0	3	0	0	0	0	2	0	3	2	5
05:00 PM	0	0	3	0	0	0	0	0	0	3	0	3
05:15 PM	0	0	0	0	0	0	0	0	0	0	0	0
05:30 PM	0	0	1	0	0	0	0	0	0	1	0	1
05:45 PM	0	0	0	0	0	0	0	0	0	0	0	0
<b>Total</b>	0	0	4	0	0	0	0	0	0	4	0	4
<b>Grand Total</b>	0	0	7	0	0	0	0	2	0	7	2	9
Apprch %	0	0		0	0		0	100				
Total %	0	0		0	0		0	100		77.8	22.2	

Start Time	North St From North			Pleasant St From East			Pleasant St From West			Int. Total
	Left	Right	App. Total	Thru	Right	App. Total	Left	Thru	App. Total	
Peak Hour Analysis From 04:00 PM to 05:45 PM - Peak 1 of 1										
Peak Hour for Entire Intersection Begins at 04:00 PM										
04:00 PM	0	0	0	0	0	0	0	0	0	0
04:15 PM	0	0	0	0	0	0	0	0	0	0
04:30 PM	0	0	0	0	0	0	0	2	2	2
04:45 PM	0	0	0	0	0	0	0	0	0	0
<b>Total Volume</b>	0	0	0	0	0	0	0	2	2	2
<b>% App. Total</b>	0	0		0	0		0	100		
<b>PHF</b>	.000	.000	.000	.000	.000	.000	.000	.250	.250	.250

# Accurate Counts

978-664-2565

File Name : 202700B6

Site Code : 20270006

Start Date : 10/2/2024

Page No : 11

N/S Street : North Street  
 E/W Street : Pleasant Street  
 City/State : Bridgewater, MA  
 Weather : Clear

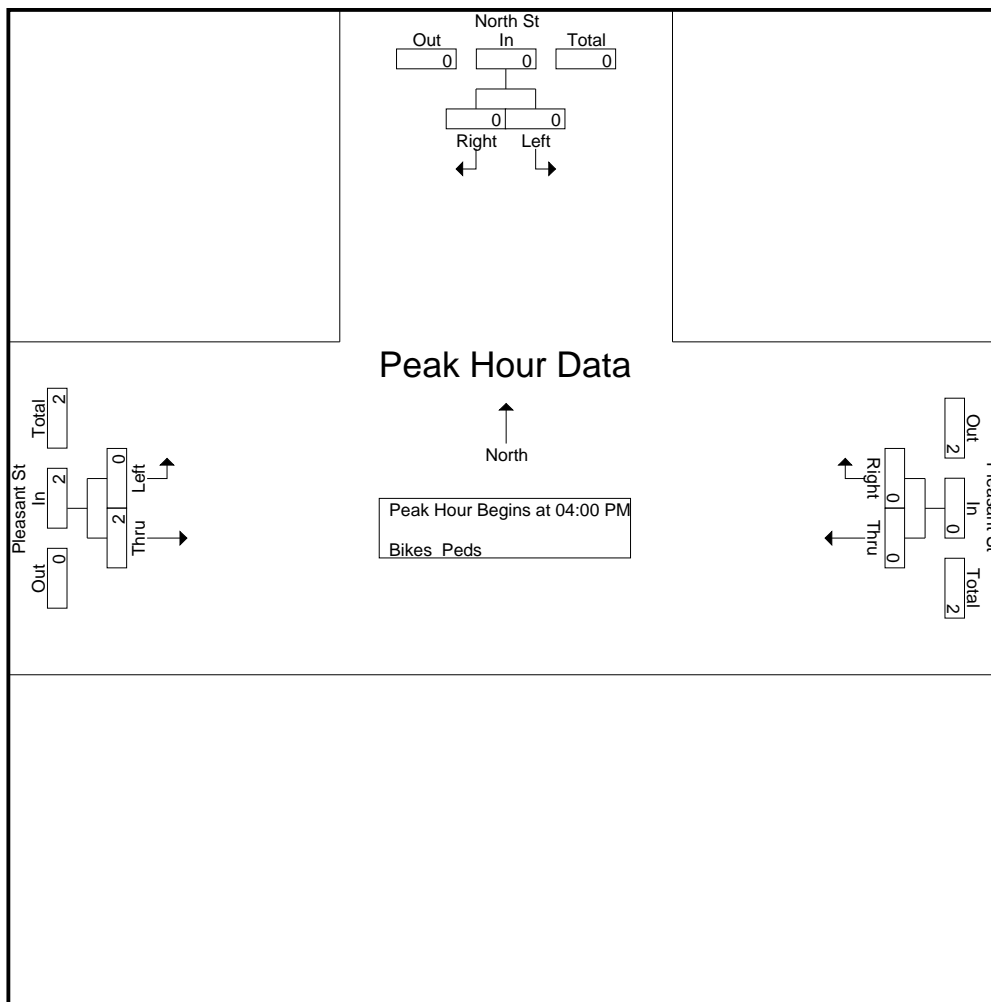

**Peak Hour Analysis From 04:00 PM to 05:45 PM - Peak 1 of 1**

Peak Hour for Each Approach Begins at:

	04:00 PM			04:00 PM			04:00 PM		
+0 mins.	0	0	0	0	0	0	0	0	0
+15 mins.	0	0	0	0	0	0	0	0	0
+30 mins.	0	0	0	0	0	0	0	2	2
+45 mins.	0	0	0	0	0	0	0	0	0
<b>Total Volume</b>	0	0	0	0	0	0	0	2	2
<b>% App. Total</b>	0	0	0	0	0	0	0	100	100
<b>PHF</b>	.000	.000	.000	.000	.000	.000	.000	.250	.250

# Accurate Counts

978-664-2565

N/S Street : North Street  
E/W Street : Pleasant Street  
City/State : Bridgewater, MA  
Weather : Clear

File Name : 202700B6  
Site Code : 20270006  
Start Date : 10/2/2024  
Page No : 12

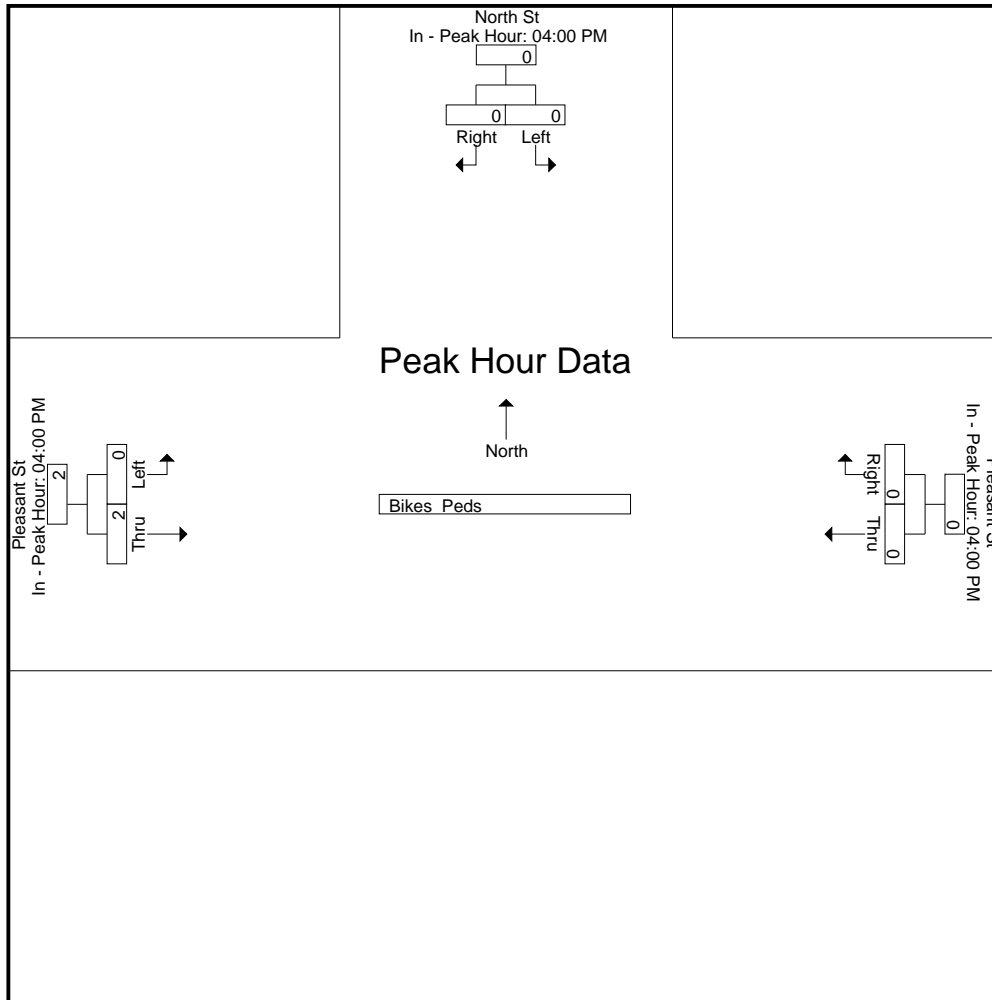



# Accurate Counts

978-664-2565

N/S Street : Birch Street  
 E/W Street : Pleasant Street  
 City/State : Bridgewater, MA  
 Weather : Clear

File Name : 202700B7  
 Site Code : 20270007  
 Start Date : 10/2/2024  
 Page No : 1

### Groups Printed- Cars - Trucks

Start Time	Birch St From North		Pleasant St From East		Pleasant St From West		Int. Total
	Left	Right	Thru	Right	Left	Thru	
07:00 AM	6	0	192	8	0	188	394
07:15 AM	6	1	240	9	0	193	449
07:30 AM	7	1	180	4	1	219	412
07:45 AM	8	0	182	5	0	223	418
<b>Total</b>	<b>27</b>	<b>2</b>	<b>794</b>	<b>26</b>	<b>1</b>	<b>823</b>	<b>1673</b>
08:00 AM	5	0	200	9	0	223	437
08:15 AM	5	1	205	2	0	223	436
08:30 AM	8	2	144	6	0	210	370
08:45 AM	18	1	171	11	0	193	394
<b>Total</b>	<b>36</b>	<b>4</b>	<b>720</b>	<b>28</b>	<b>0</b>	<b>849</b>	<b>1637</b>
<b>Grand Total</b>	<b>63</b>	<b>6</b>	<b>1514</b>	<b>54</b>	<b>1</b>	<b>1672</b>	<b>3310</b>
Apprch %	91.3	8.7	96.6	3.4	0.1	99.9	
Total %	1.9	0.2	45.7	1.6	0	50.5	
Cars	62	6	1470	54	1	1616	3209
% Cars	98.4	100	97.1	100	100	96.7	96.9
Trucks	1	0	44	0	0	56	101
% Trucks	1.6	0	2.9	0	0	3.3	3.1

Start Time	Birch St From North			Pleasant St From East			Pleasant St From West			Int. Total
	Left	Right	App. Total	Thru	Right	App. Total	Left	Thru	App. Total	
Peak Hour Analysis From 07:00 AM to 08:45 AM - Peak 1 of 1										
Peak Hour for Entire Intersection Begins at 07:15 AM										
07:15 AM	6	1	7	240	9	249	0	193	193	449
07:30 AM	7	1	8	180	4	184	1	219	220	412
07:45 AM	8	0	8	182	5	187	0	223	223	418
08:00 AM	5	0	5	200	9	209	0	223	223	437
<b>Total Volume</b>	<b>26</b>	<b>2</b>	<b>28</b>	<b>802</b>	<b>27</b>	<b>829</b>	<b>1</b>	<b>858</b>	<b>859</b>	<b>1716</b>
% App. Total	92.9	7.1		96.7	3.3		0.1	99.9		
PHF	.813	.500	.875	.835	.750	.832	.250	.962	.963	.955
Cars	26	2	28	786	27	813	1	831	832	1673
% Cars	100	100	100	98.0	100	98.1	100	96.9	96.9	97.5
Trucks	0	0	0	16	0	16	0	27	27	43
% Trucks	0	0	0	2.0	0	1.9	0	3.1	3.1	2.5

# Accurate Counts

978-664-2565

N/S Street : Birch Street  
 E/W Street : Pleasant Street  
 City/State : Bridgewater, MA  
 Weather : Clear

File Name : 202700B7  
 Site Code : 20270007  
 Start Date : 10/2/2024  
 Page No : 2

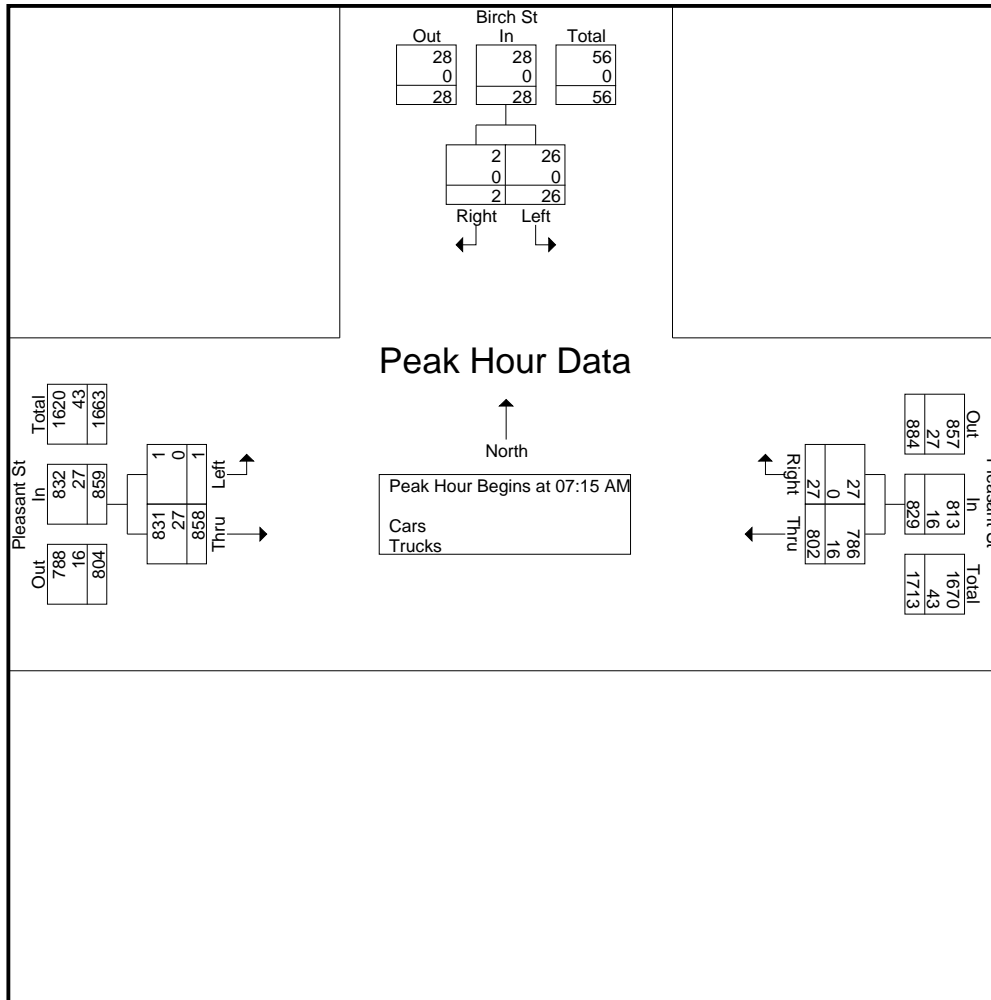

**Peak Hour Analysis From 07:00 AM to 08:45 AM - Peak 1 of 1**

Peak Hour for Each Approach Begins at:

	08:00 AM			07:15 AM			07:30 AM		
+0 mins.	5	0	5	<b>240</b>	<b>9</b>	<b>249</b>	<b>1</b>	219	220
+15 mins.	5	1	6	180	4	184	0	<b>223</b>	<b>223</b>
+30 mins.	8	<b>2</b>	10	182	5	187	0	223	223
+45 mins.	<b>18</b>	1	<b>19</b>	200	9	209	0	223	223
Total Volume	36	4	40	802	27	829	1	888	889
% App. Total	90	10		96.7	3.3		0.1	99.9	
PHF	.500	.500	.526	.835	.750	.832	.250	.996	.997
Cars	35	4	39	786	27	813	1	859	860
% Cars	97.2	100	97.5	98	100	98.1	100	96.7	96.7
Trucks	1	0	1	16	0	16	0	29	29
% Trucks	2.8	0	2.5	2	0	1.9	0	3.3	3.3

# Accurate Counts

978-664-2565

File Name : 202700B7

Site Code : 20270007

Start Date : 10/2/2024

Page No : 3

N/S Street : Birch Street  
 E/W Street : Pleasant Street  
 City/State : Bridgewater, MA  
 Weather : Clear

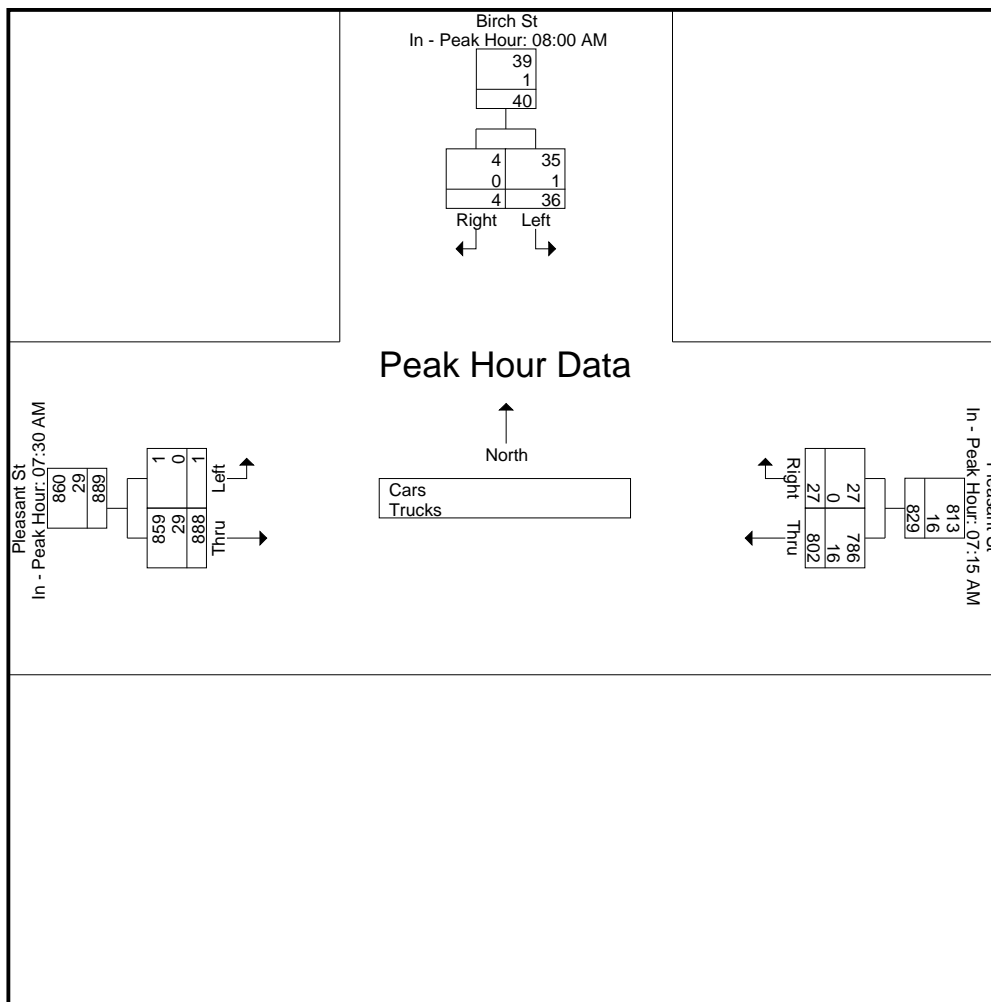

# Accurate Counts

978-664-2565

N/S Street : Birch Street  
 E/W Street : Pleasant Street  
 City/State : Bridgewater, MA  
 Weather : Clear

File Name : 202700B7  
 Site Code : 20270007  
 Start Date : 10/2/2024  
 Page No : 4

## Groups Printed- Cars

Start Time	Birch St From North		Pleasant St From East		Pleasant St From West		Int. Total
	Left	Right	Thru	Right	Left	Thru	
07:00 AM	6	0	183	8	0	182	379
07:15 AM	6	1	240	9	0	187	443
07:30 AM	7	1	175	4	1	212	400
07:45 AM	8	0	175	5	0	220	408
<b>Total</b>	<b>27</b>	<b>2</b>	<b>773</b>	<b>26</b>	<b>1</b>	<b>801</b>	<b>1630</b>
08:00 AM	5	0	196	9	0	212	422
08:15 AM	5	1	193	2	0	215	416
08:30 AM	8	2	138	6	0	202	356
08:45 AM	17	1	170	11	0	186	385
<b>Total</b>	<b>35</b>	<b>4</b>	<b>697</b>	<b>28</b>	<b>0</b>	<b>815</b>	<b>1579</b>
<b>Grand Total</b>	<b>62</b>	<b>6</b>	<b>1470</b>	<b>54</b>	<b>1</b>	<b>1616</b>	<b>3209</b>
Apprch %	91.2	8.8	96.5	3.5	0.1	99.9	
Total %	1.9	0.2	45.8	1.7	0	50.4	

Start Time	Birch St From North			Pleasant St From East			Pleasant St From West			Int. Total
	Left	Right	App. Total	Thru	Right	App. Total	Left	Thru	App. Total	
Peak Hour Analysis From 07:00 AM to 08:45 AM - Peak 1 of 1										
Peak Hour for Entire Intersection Begins at 07:15 AM										
07:15 AM	6	1	7	240	9	249	0	187	187	443
07:30 AM	7	1	8	175	4	179	1	212	213	400
07:45 AM	8	0	8	175	5	180	0	220	220	408
08:00 AM	5	0	5	196	9	205	0	212	212	422
<b>Total Volume</b>	<b>26</b>	<b>2</b>	<b>28</b>	<b>786</b>	<b>27</b>	<b>813</b>	<b>1</b>	<b>831</b>	<b>832</b>	<b>1673</b>
% App. Total	92.9	7.1		96.7	3.3		0.1	99.9		
PHF	.813	.500	.875	.819	.750	.816	.250	.944	.945	.944

# Accurate Counts

978-664-2565

N/S Street : Birch Street  
 E/W Street : Pleasant Street  
 City/State : Bridgewater, MA  
 Weather : Clear

File Name : 202700B7  
 Site Code : 20270007  
 Start Date : 10/2/2024  
 Page No : 5

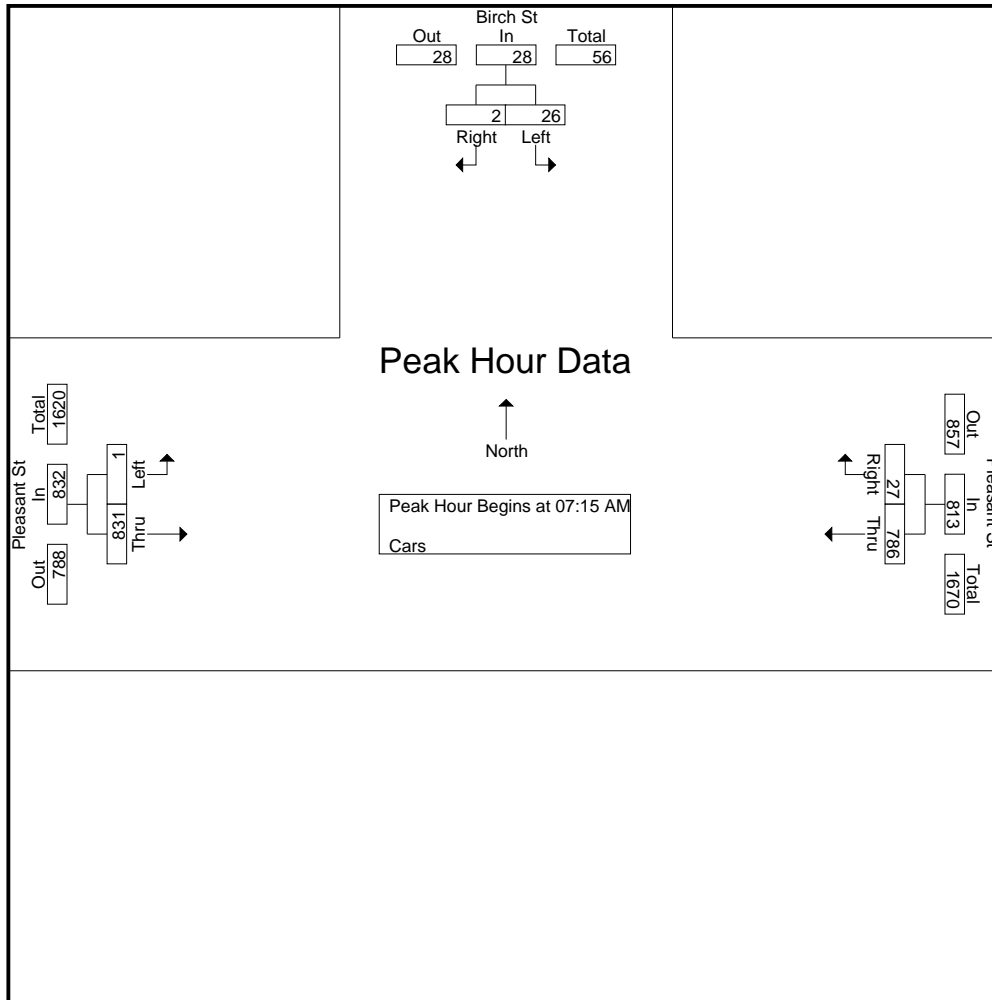

**Peak Hour Analysis From 07:00 AM to 08:45 AM - Peak 1 of 1**

Peak Hour for Each Approach Begins at:

	08:00 AM			07:15 AM			07:30 AM		
+0 mins.	5	0	5	<b>240</b>	<b>9</b>	<b>249</b>	<b>1</b>	212	213
+15 mins.	5	1	6	175	4	179	0	<b>220</b>	<b>220</b>
+30 mins.	8	<b>2</b>	10	175	5	180	0	212	212
+45 mins.	<b>17</b>	1	<b>18</b>	196	9	205	0	215	215
Total Volume	35	4	39	786	27	813	1	859	860
% App. Total	89.7	10.3		96.7	3.3		0.1	99.9	
PHF	.515	.500	.542	.819	.750	.816	.250	.976	.977

# Accurate Counts

978-664-2565

File Name : 202700B7

Site Code : 20270007

Start Date : 10/2/2024

Page No : 6

N/S Street : Birch Street  
E/W Street : Pleasant Street  
City/State : Bridgewater, MA  
Weather : Clear

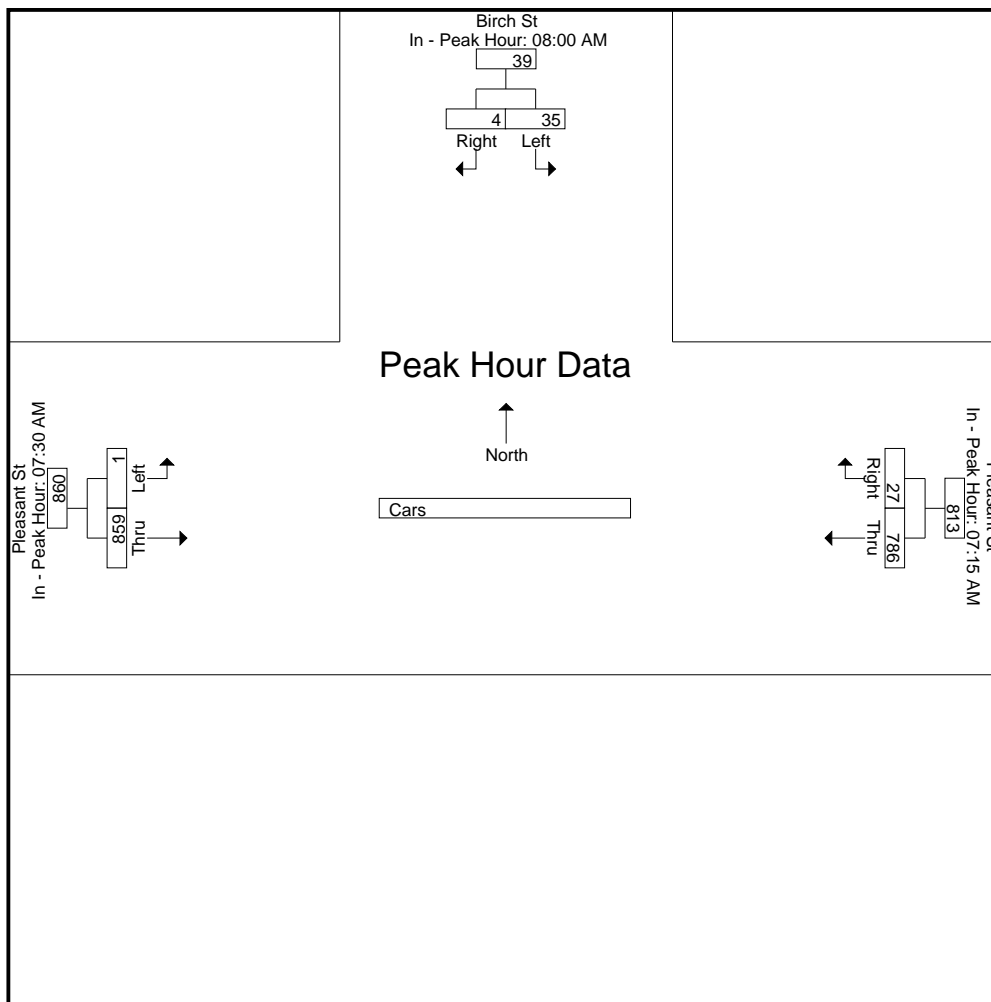

# Accurate Counts

978-664-2565

N/S Street : Birch Street  
 E/W Street : Pleasant Street  
 City/State : Bridgewater, MA  
 Weather : Clear

File Name : 202700B7  
 Site Code : 20270007  
 Start Date : 10/2/2024  
 Page No : 7

### Groups Printed- Trucks

Start Time	Birch St From North		Pleasant St From East		Pleasant St From West		Int. Total
	Left	Right	Thru	Right	Left	Thru	
07:00 AM	0	0	9	0	0	6	15
07:15 AM	0	0	0	0	0	6	6
07:30 AM	0	0	5	0	0	7	12
07:45 AM	0	0	7	0	0	3	10
<b>Total</b>	0	0	21	0	0	22	43
08:00 AM	0	0	4	0	0	11	15
08:15 AM	0	0	12	0	0	8	20
08:30 AM	0	0	6	0	0	8	14
08:45 AM	1	0	1	0	0	7	9
<b>Total</b>	1	0	23	0	0	34	58
<b>Grand Total</b>	1	0	44	0	0	56	101
Apprch %	100	0	100	0	0	100	
Total %	1	0	43.6	0	0	55.4	

Start Time	Birch St From North			Pleasant St From East			Pleasant St From West			Int. Total
	Left	Right	App. Total	Thru	Right	App. Total	Left	Thru	App. Total	
Peak Hour Analysis From 07:00 AM to 08:45 AM - Peak 1 of 1										
Peak Hour for Entire Intersection Begins at 07:45 AM										
07:45 AM	0	0	0	7	0	7	0	3	3	10
08:00 AM	0	0	0	4	0	4	0	11	11	15
08:15 AM	0	0	0	12	0	12	0	8	8	20
08:30 AM	0	0	0	6	0	6	0	8	8	14
Total Volume	0	0	0	29	0	29	0	30	30	59
% App. Total	0	0	0	100	0	100	0	100	100	
PHF	.000	.000	.000	.604	.000	.604	.000	.682	.682	.738

# Accurate Counts

978-664-2565

N/S Street : Birch Street  
 E/W Street : Pleasant Street  
 City/State : Bridgewater, MA  
 Weather : Clear

File Name : 202700B7  
 Site Code : 20270007  
 Start Date : 10/2/2024  
 Page No : 8

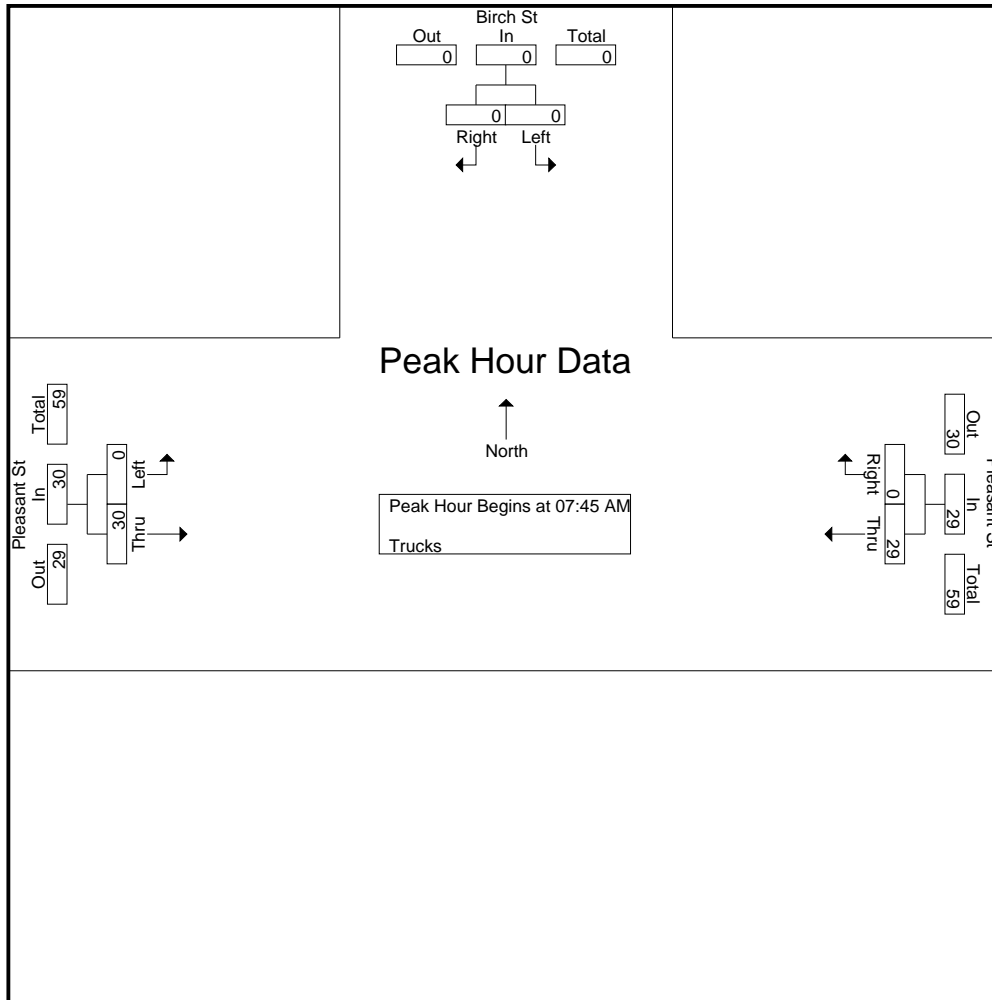

**Peak Hour Analysis From 07:00 AM to 08:45 AM - Peak 1 of 1**

Peak Hour for Each Approach Begins at:

	08:00 AM			07:45 AM			08:00 AM		
+0 mins.	0	0	0	7	0	7	0	11	11
+15 mins.	0	0	0	4	0	4	0	8	8
+30 mins.	0	0	0	12	0	12	0	8	8
+45 mins.	1	0	1	6	0	6	0	7	7
<b>Total Volume</b>	1	0	1	29	0	29	0	34	34
<b>% App. Total</b>	100	0		100	0		0	100	
<b>PHF</b>	.250	.000	.250	.604	.000	.604	.000	.773	.773



# Accurate Counts

978-664-2565

File Name : 202700B7

Site Code : 20270007

Start Date : 10/2/2024

Page No : 9

N/S Street : Birch Street

E/W Street : Pleasant Street

City/State : Bridgewater, MA

Weather : Clear

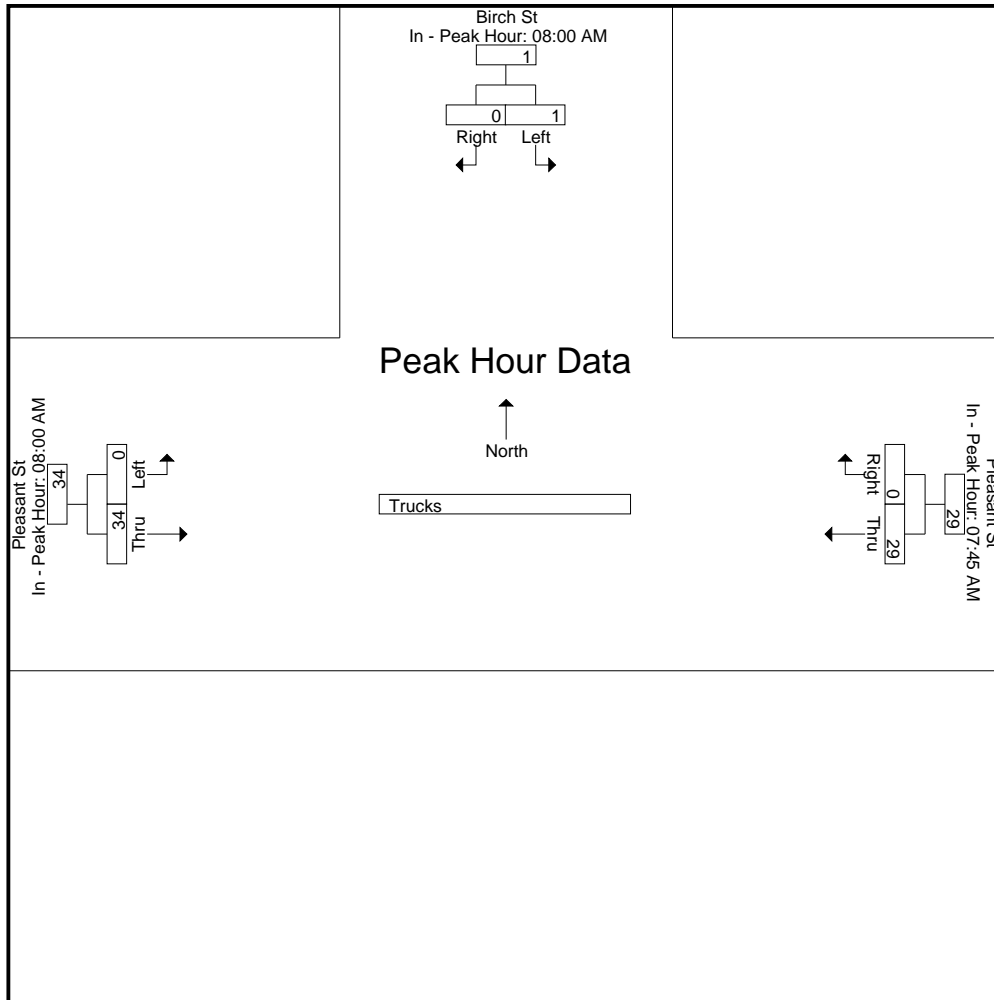

# Accurate Counts

978-664-2565

N/S Street : Birch Street  
 E/W Street : Pleasant Street  
 City/State : Bridgewater, MA  
 Weather : Clear

File Name : 202700B7  
 Site Code : 20270007  
 Start Date : 10/2/2024  
 Page No : 10

### Groups Printed- Bikes Peds

Start Time	Birch St From North			Pleasant St From East			Pleasant St From West			Exclu. Total	Inclu. Total	Int. Total
	Left	Right	Peds	Thru	Right	Peds	Left	Thru	Peds			
07:00 AM	0	0	0	0	0	0	0	0	0	0	0	0
07:15 AM	0	0	1	0	0	0	0	0	0	1	0	1
07:30 AM	0	0	0	0	0	0	0	0	0	0	0	0
07:45 AM	0	0	0	0	0	0	0	1	0	0	1	1
<b>Total</b>	0	0	1	0	0	0	0	1	0	1	1	2
08:00 AM	0	0	0	0	0	0	0	0	0	0	0	0
08:15 AM	0	0	1	0	0	0	0	0	0	1	0	1
08:30 AM	0	0	1	0	0	0	0	0	0	1	0	1
08:45 AM	0	0	0	0	0	0	0	0	0	0	0	0
<b>Total</b>	0	0	2	0	0	0	0	0	0	2	0	2
<b>Grand Total</b>	0	0	3	0	0	0	0	1	0	3	1	4
Apprch %	0	0		0	0		0	100				
Total %	0	0		0	0		0	100		75	25	

Start Time	Birch St From North			Pleasant St From East			Pleasant St From West			Int. Total
	Left	Right	App. Total	Thru	Right	App. Total	Left	Thru	App. Total	
Peak Hour Analysis From 07:00 AM to 08:45 AM - Peak 1 of 1										
Peak Hour for Entire Intersection Begins at 07:00 AM										
07:00 AM	0	0	0	0	0	0	0	0	0	0
07:15 AM	0	0	0	0	0	0	0	0	0	0
07:30 AM	0	0	0	0	0	0	0	0	0	0
07:45 AM	0	0	0	0	0	0	0	1	1	1
<b>Total Volume</b>	0	0	0	0	0	0	0	1	1	1
<b>% App. Total</b>	0	0		0	0		0	100		
<b>PHF</b>	.000	.000	.000	.000	.000	.000	.000	.250	.250	.250

# Accurate Counts

978-664-2565

N/S Street : Birch Street  
 E/W Street : Pleasant Street  
 City/State : Bridgewater, MA  
 Weather : Clear

File Name : 202700B7  
 Site Code : 20270007  
 Start Date : 10/2/2024  
 Page No : 11

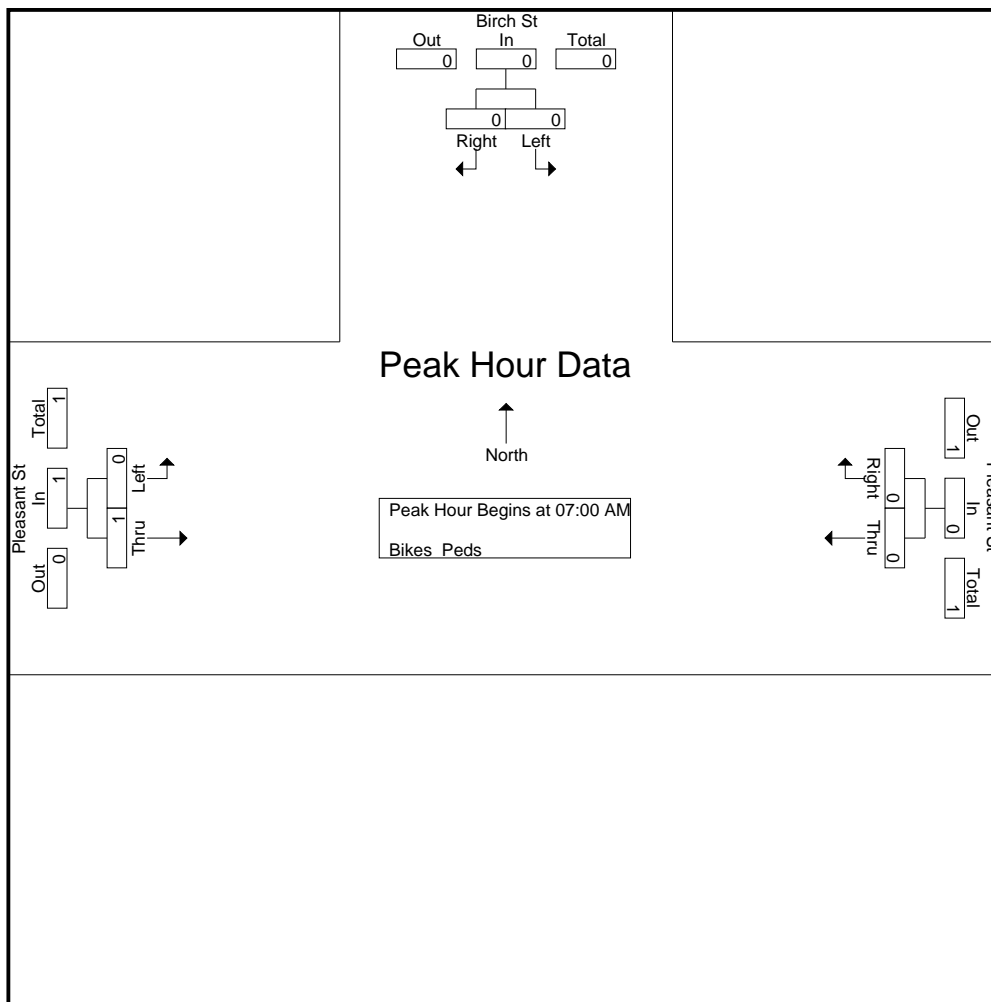

**Peak Hour Analysis From 07:00 AM to 08:45 AM - Peak 1 of 1**

Peak Hour for Each Approach Begins at:

	07:00 AM			07:00 AM			07:00 AM		
+0 mins.	0	0	0	0	0	0	0	0	0
+15 mins.	0	0	0	0	0	0	0	0	0
+30 mins.	0	0	0	0	0	0	0	0	0
+45 mins.	0	0	0	0	0	0	0	1	1
Total Volume	0	0	0	0	0	0	0	1	1
% App. Total	0	0	0	0	0	0	0	100	100
PHF	.000	.000	.000	.000	.000	.000	.000	.250	.250

# Accurate Counts

978-664-2565

File Name : 202700B7

Site Code : 20270007

Start Date : 10/2/2024

Page No : 12

N/S Street : Birch Street  
E/W Street : Pleasant Street  
City/State : Bridgewater, MA  
Weather : Clear

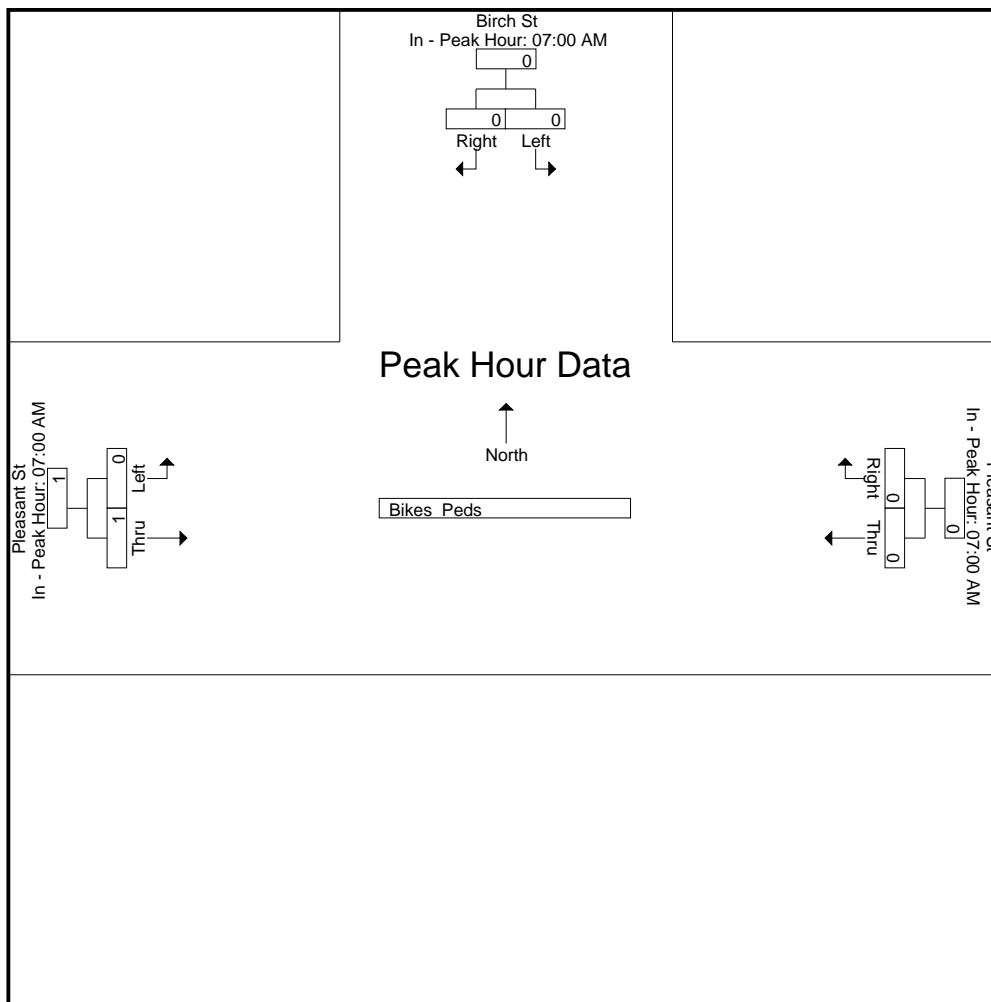

# Accurate Counts

978-664-2565

N/S Street : Birch Street  
 E/W Street : Pleasant Street  
 City/State : Bridgewater, MA  
 Weather : Clear

File Name : 202700B7  
 Site Code : 20270007  
 Start Date : 10/2/2024  
 Page No : 1

### Groups Printed- Cars - Trucks

Start Time	Birch St From North		Pleasant St From East		Pleasant St From West		Int. Total
	Left	Right	Thru	Right	Left	Thru	
04:00 PM	13	1	223	12	1	219	469
04:15 PM	4	1	228	13	2	207	455
04:30 PM	9	2	220	14	2	195	442
04:45 PM	8	2	202	11	0	206	429
<b>Total</b>	<b>34</b>	<b>6</b>	<b>873</b>	<b>50</b>	<b>5</b>	<b>827</b>	<b>1795</b>
05:00 PM	7	4	208	11	0	219	449
05:15 PM	12	0	215	9	2	237	475
05:30 PM	3	2	209	8	1	210	433
05:45 PM	6	0	172	7	0	209	394
<b>Total</b>	<b>28</b>	<b>6</b>	<b>804</b>	<b>35</b>	<b>3</b>	<b>875</b>	<b>1751</b>
<b>Grand Total</b>	<b>62</b>	<b>12</b>	<b>1677</b>	<b>85</b>	<b>8</b>	<b>1702</b>	<b>3546</b>
Apprch %	83.8	16.2	95.2	4.8	0.5	99.5	
Total %	1.7	0.3	47.3	2.4	0.2	48	
Cars	62	12	1663	85	8	1671	3501
% Cars	100	100	99.2	100	100	98.2	98.7
Trucks	0	0	14	0	0	31	45
% Trucks	0	0	0.8	0	0	1.8	1.3

Start Time	Birch St From North			Pleasant St From East			Pleasant St From West			Int. Total
	Left	Right	App. Total	Thru	Right	App. Total	Left	Thru	App. Total	
Peak Hour Analysis From 04:00 PM to 05:45 PM - Peak 1 of 1										
Peak Hour for Entire Intersection Begins at 04:00 PM										
04:00 PM	<b>13</b>	<b>1</b>	<b>14</b>	223	12	235	1	<b>219</b>	<b>220</b>	<b>469</b>
04:15 PM	4	1	5	<b>228</b>	13	<b>241</b>	<b>2</b>	207	209	455
04:30 PM	9	<b>2</b>	11	220	<b>14</b>	234	2	195	197	442
04:45 PM	8	2	10	202	11	213	0	206	206	429
<b>Total Volume</b>	<b>34</b>	<b>6</b>	<b>40</b>	<b>873</b>	<b>50</b>	<b>923</b>	<b>5</b>	<b>827</b>	<b>832</b>	<b>1795</b>
% App. Total	85	15		94.6	5.4		0.6	99.4		
PHF	.654	.750	.714	.957	.893	.957	.625	.944	.945	.957
Cars	34	6	40	862	50	912	5	806	811	1763
% Cars	100	100	100	98.7	100	98.8	100	97.5	97.5	98.2
Trucks	0	0	0	11	0	11	0	21	21	32
% Trucks	0	0	0	1.3	0	1.2	0	2.5	2.5	1.8

# Accurate Counts

978-664-2565

N/S Street : Birch Street  
 E/W Street : Pleasant Street  
 City/State : Bridgewater, MA  
 Weather : Clear

File Name : 202700B7  
 Site Code : 20270007  
 Start Date : 10/2/2024  
 Page No : 2

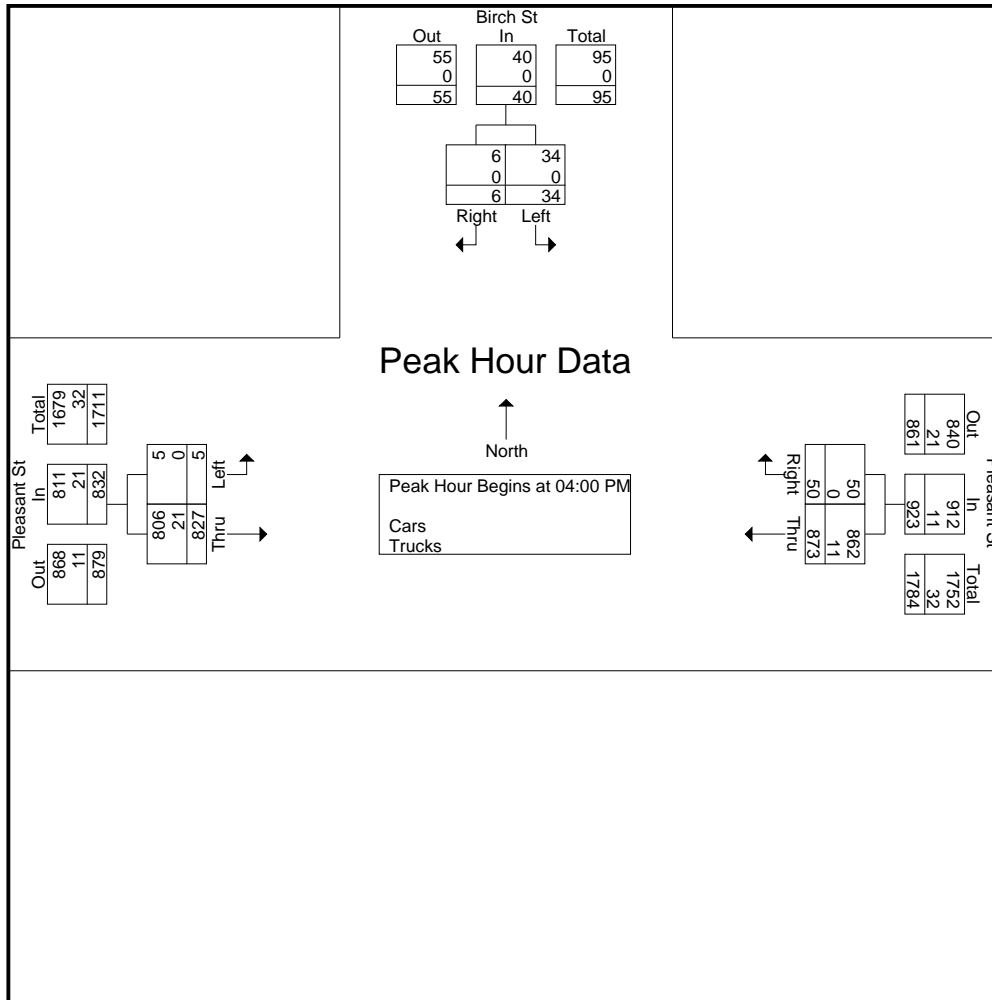

**Peak Hour Analysis From 04:00 PM to 05:45 PM - Peak 1 of 1**

Peak Hour for Each Approach Begins at:

	04:30 PM			04:00 PM			05:00 PM		
+0 mins.	9	2	11	223	12	235	0	219	219
+15 mins.	8	2	10	<b>228</b>	13	<b>241</b>	<b>2</b>	<b>237</b>	<b>239</b>
+30 mins.	7	4	11	220	<b>14</b>	234	1	210	211
+45 mins.	<b>12</b>	0	<b>12</b>	202	11	213	0	209	209
Total Volume	36	8	44	873	50	923	3	875	878
% App. Total	81.8	18.2		94.6	5.4		0.3	99.7	
PHF	.750	.500	.917	.957	.893	.957	.375	.923	.918
Cars	36	8	44	862	50	912	3	865	868
% Cars	100	100	100	98.7	100	98.8	100	98.9	98.9
Trucks	0	0	0	11	0	11	0	10	10
% Trucks	0	0	0	1.3	0	1.2	0	1.1	1.1

# Accurate Counts

978-664-2565

N/S Street : Birch Street  
 E/W Street : Pleasant Street  
 City/State : Bridgewater, MA  
 Weather : Clear

File Name : 202700B7  
 Site Code : 20270007  
 Start Date : 10/2/2024  
 Page No : 3

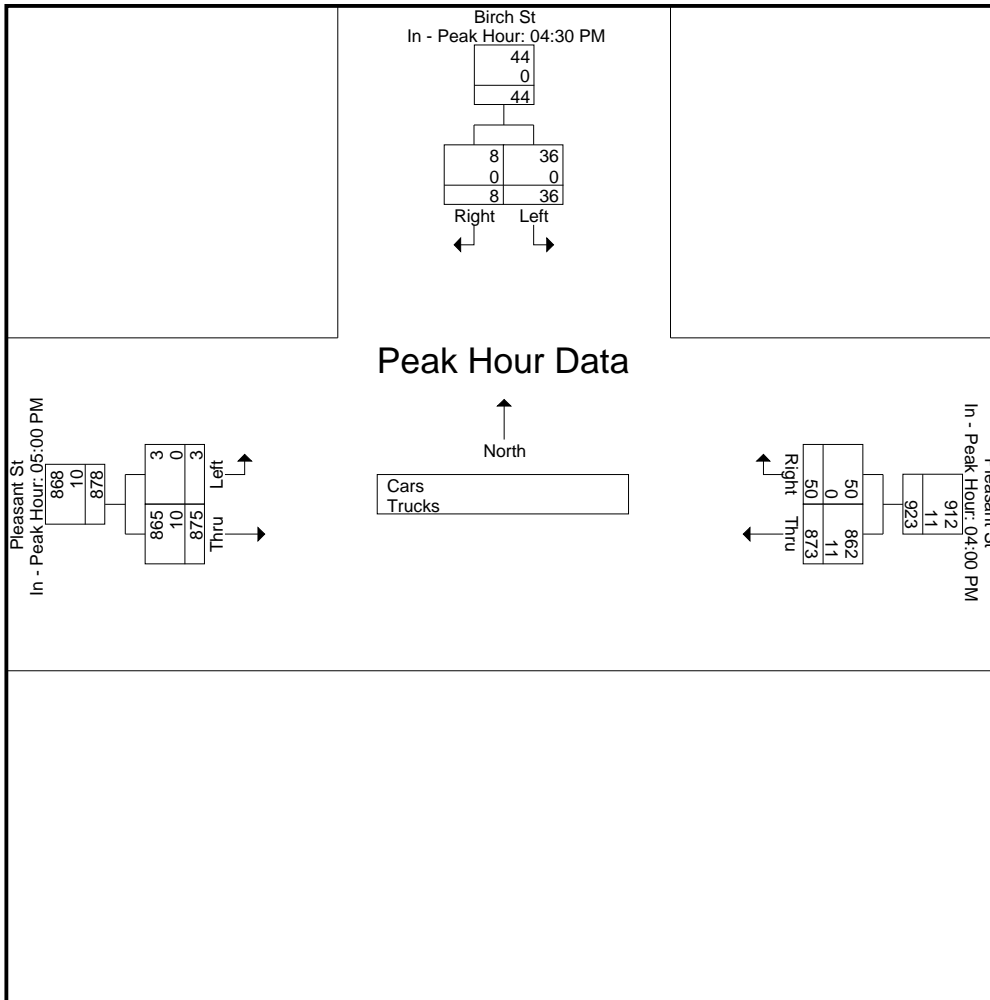

# Accurate Counts

978-664-2565

N/S Street : Birch Street  
 E/W Street : Pleasant Street  
 City/State : Bridgewater, MA  
 Weather : Clear

File Name : 202700B7  
 Site Code : 20270007  
 Start Date : 10/2/2024  
 Page No : 4

## Groups Printed- Cars

Start Time	Birch St From North		Pleasant St From East		Pleasant St From West		Int. Total
	Left	Right	Thru	Right	Left	Thru	
04:00 PM	13	1	221	12	1	215	463
04:15 PM	4	1	223	13	2	199	442
04:30 PM	9	2	219	14	2	189	435
04:45 PM	8	2	199	11	0	203	423
<b>Total</b>	<b>34</b>	<b>6</b>	<b>862</b>	<b>50</b>	<b>5</b>	<b>806</b>	<b>1763</b>
05:00 PM	7	4	206	11	0	215	443
05:15 PM	12	0	214	9	2	236	473
05:30 PM	3	2	209	8	1	207	430
05:45 PM	6	0	172	7	0	207	392
<b>Total</b>	<b>28</b>	<b>6</b>	<b>801</b>	<b>35</b>	<b>3</b>	<b>865</b>	<b>1738</b>
<b>Grand Total</b>	<b>62</b>	<b>12</b>	<b>1663</b>	<b>85</b>	<b>8</b>	<b>1671</b>	<b>3501</b>
Apprch %	83.8	16.2	95.1	4.9	0.5	99.5	
Total %	1.8	0.3	47.5	2.4	0.2	47.7	

Start Time	Birch St From North			Pleasant St From East			Pleasant St From West			Int. Total
	Left	Right	App. Total	Thru	Right	App. Total	Left	Thru	App. Total	
Peak Hour Analysis From 04:00 PM to 05:45 PM - Peak 1 of 1										
Peak Hour for Entire Intersection Begins at 04:30 PM										
04:30 PM	9	2	11	<b>219</b>	<b>14</b>	<b>233</b>	<b>2</b>	189	191	435
04:45 PM	8	2	10	199	11	210	0	203	203	423
05:00 PM	7	<b>4</b>	11	206	11	217	0	215	215	443
05:15 PM	<b>12</b>	0	<b>12</b>	214	9	223	2	<b>236</b>	<b>238</b>	<b>473</b>
Total Volume	36	8	44	838	45	883	4	843	847	1774
% App. Total	81.8	18.2		94.9	5.1		0.5	99.5		
PHF	.750	.500	.917	.957	.804	.947	.500	.893	.890	.938



# Accurate Counts

978-664-2565

N/S Street : Birch Street  
 E/W Street : Pleasant Street  
 City/State : Bridgewater, MA  
 Weather : Clear

File Name : 202700B7  
 Site Code : 20270007  
 Start Date : 10/2/2024  
 Page No : 5

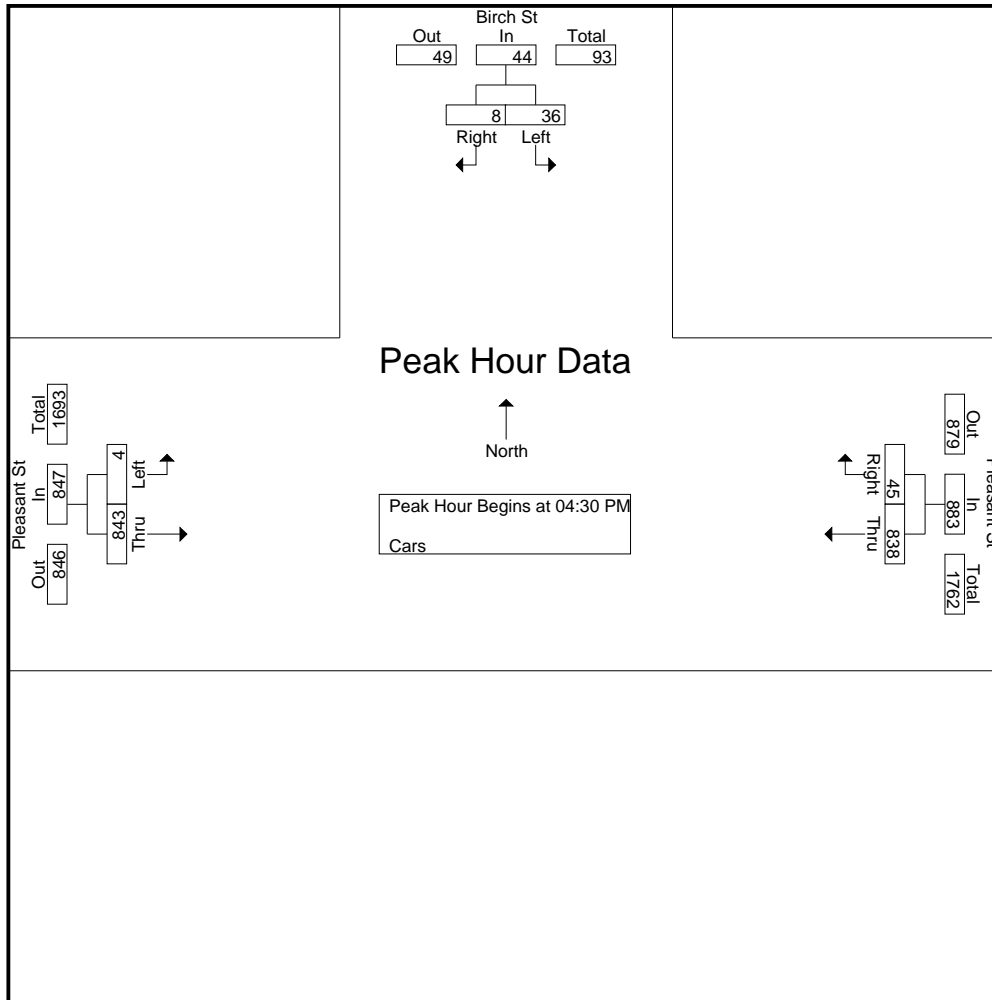

**Peak Hour Analysis From 04:00 PM to 05:45 PM - Peak 1 of 1**

Peak Hour for Each Approach Begins at:

	04:30 PM			04:00 PM			05:00 PM		
+0 mins.	9	2	11	221	12	233	0	215	215
+15 mins.	8	2	10	<b>223</b>	13	<b>236</b>	<b>2</b>	<b>236</b>	<b>238</b>
+30 mins.	7	4	11	219	<b>14</b>	233	1	207	208
+45 mins.	<b>12</b>	0	<b>12</b>	199	11	210	0	207	207
Total Volume	36	8	44	862	50	912	3	865	868
% App. Total	81.8	18.2		94.5	5.5		0.3	99.7	
PHF	.750	.500	.917	.966	.893	.966	.375	.916	.912

# Accurate Counts

978-664-2565

File Name : 202700B7

Site Code : 20270007

Start Date : 10/2/2024

Page No : 6

N/S Street : Birch Street  
E/W Street : Pleasant Street  
City/State : Bridgewater, MA  
Weather : Clear

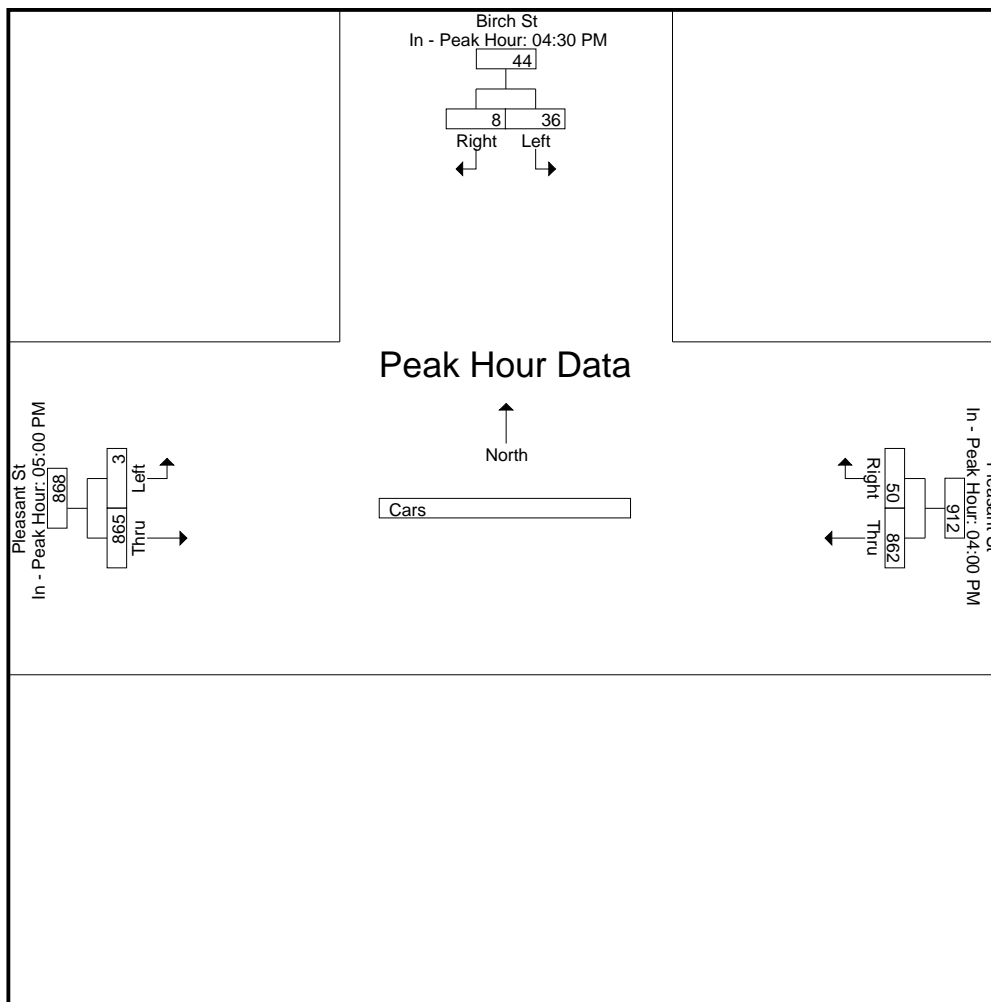

# Accurate Counts

978-664-2565

N/S Street : Birch Street  
 E/W Street : Pleasant Street  
 City/State : Bridgewater, MA  
 Weather : Clear

File Name : 202700B7  
 Site Code : 20270007  
 Start Date : 10/2/2024  
 Page No : 7

### Groups Printed- Trucks

Start Time	Birch St From North		Pleasant St From East		Pleasant St From West		Int. Total
	Left	Right	Thru	Right	Left	Thru	
04:00 PM	0	0	2	0	0	4	6
04:15 PM	0	0	5	0	0	8	13
04:30 PM	0	0	1	0	0	6	7
04:45 PM	0	0	3	0	0	3	6
<b>Total</b>	0	0	11	0	0	21	32
05:00 PM	0	0	2	0	0	4	6
05:15 PM	0	0	1	0	0	1	2
05:30 PM	0	0	0	0	0	3	3
05:45 PM	0	0	0	0	0	2	2
<b>Total</b>	0	0	3	0	0	10	13
<b>Grand Total</b>	0	0	14	0	0	31	45
Apprch %	0	0	100	0	0	100	
Total %	0	0	31.1	0	0	68.9	

Start Time	Birch St From North			Pleasant St From East			Pleasant St From West			Int. Total
	Left	Right	App. Total	Thru	Right	App. Total	Left	Thru	App. Total	
Peak Hour Analysis From 04:00 PM to 05:45 PM - Peak 1 of 1										
Peak Hour for Entire Intersection Begins at 04:00 PM										
04:00 PM	0	0	0	2	0	2	0	4	4	6
04:15 PM	0	0	0	5	0	5	0	8	8	13
04:30 PM	0	0	0	1	0	1	0	6	6	7
04:45 PM	0	0	0	3	0	3	0	3	3	6
<b>Total Volume</b>	0	0	0	11	0	11	0	21	21	32
% App. Total	0	0		100	0		0	100		
PHF	.000	.000	.000	.550	.000	.550	.000	.656	.656	.615

# Accurate Counts

978-664-2565

File Name : 202700B7

Site Code : 20270007

Start Date : 10/2/2024

Page No : 8

N/S Street : Birch Street  
 E/W Street : Pleasant Street  
 City/State : Bridgewater, MA  
 Weather : Clear

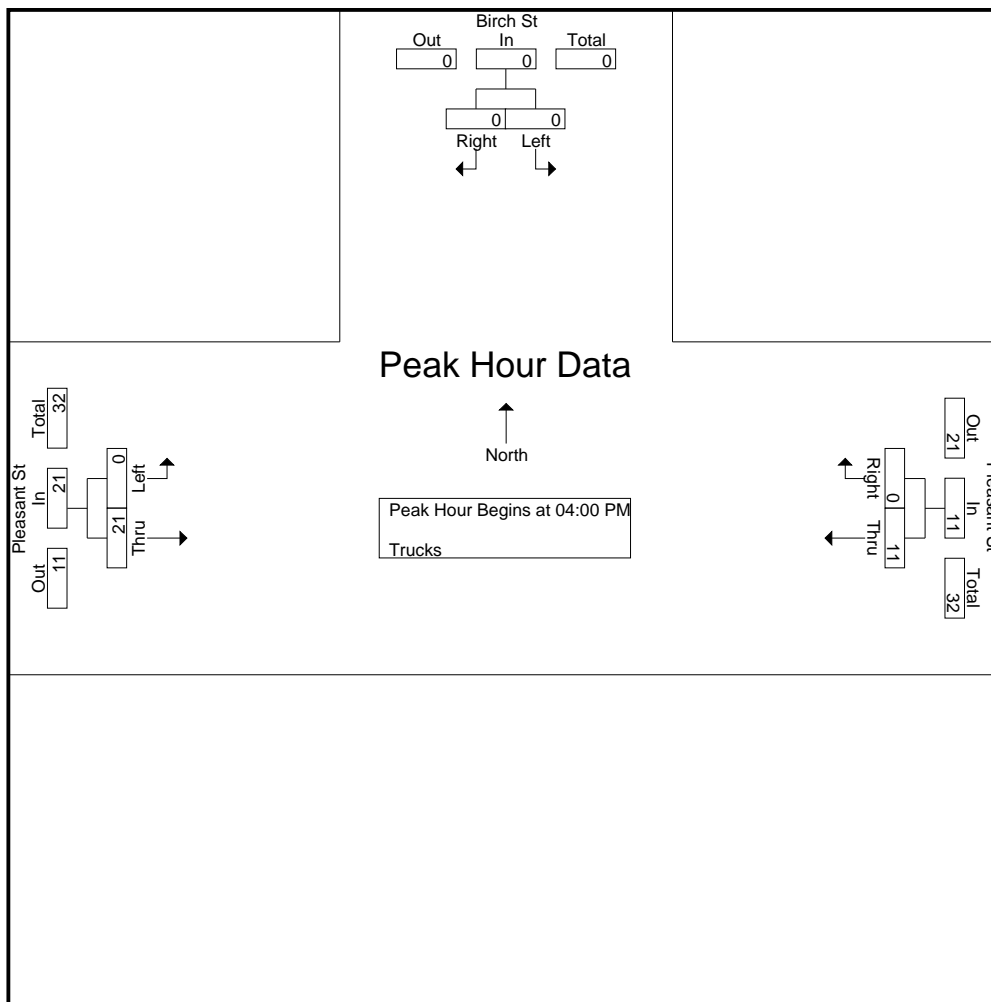

**Peak Hour Analysis From 04:00 PM to 05:45 PM - Peak 1 of 1**

Peak Hour for Each Approach Begins at:

	04:00 PM			04:00 PM			04:00 PM		
+0 mins.	0	0	0	2	0	2	0	4	4
+15 mins.	0	0	0	5	0	5	0	8	8
+30 mins.	0	0	0	1	0	1	0	6	6
+45 mins.	0	0	0	3	0	3	0	3	3
<b>Total Volume</b>	0	0	0	11	0	11	0	21	21
<b>% App. Total</b>	0	0	0	100	0	100	0	100	100
<b>PHF</b>	.000	.000	.000	.550	.000	.550	.000	.656	.656

# Accurate Counts

978-664-2565

File Name : 202700B7

Site Code : 20270007

Start Date : 10/2/2024

Page No : 9

N/S Street : Birch Street  
E/W Street : Pleasant Street  
City/State : Bridgewater, MA  
Weather : Clear

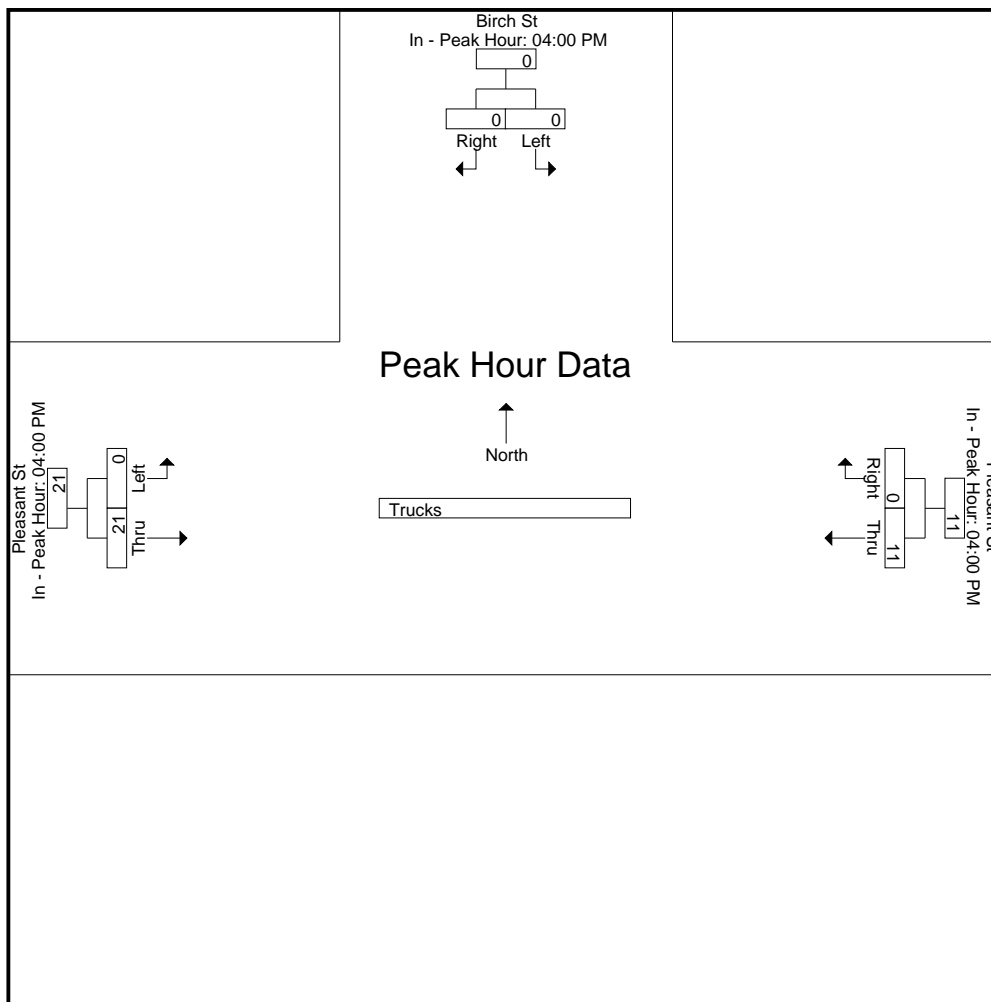

# Accurate Counts

978-664-2565

N/S Street : Birch Street  
 E/W Street : Pleasant Street  
 City/State : Bridgewater, MA  
 Weather : Clear

File Name : 202700B7  
 Site Code : 20270007  
 Start Date : 10/2/2024  
 Page No : 10

## Groups Printed- Bikes Peds

Start Time	Birch St From North			Pleasant St From East			Pleasant St From West			Exclu. Total	Inclu. Total	Int. Total
	Left	Right	Peds	Thru	Right	Peds	Left	Thru	Peds			
04:00 PM	0	0	3	0	0	0	0	0	0	3	0	3
04:15 PM	0	0	0	0	5	0	0	0	0	0	5	5
04:30 PM	0	0	0	0	0	0	0	2	0	0	2	2
04:45 PM	0	0	3	0	0	0	0	0	0	3	0	3
<b>Total</b>	<b>0</b>	<b>0</b>	<b>6</b>	<b>0</b>	<b>5</b>	<b>0</b>	<b>0</b>	<b>2</b>	<b>0</b>	<b>6</b>	<b>7</b>	<b>13</b>
05:00 PM	0	0	0	0	1	0	0	0	0	0	1	1
05:15 PM	0	0	0	0	0	0	0	0	0	0	0	0
05:30 PM	0	0	0	0	0	0	0	0	0	0	0	0
05:45 PM	2	0	1	0	0	0	0	0	0	1	2	3
<b>Total</b>	<b>2</b>	<b>0</b>	<b>1</b>	<b>0</b>	<b>1</b>	<b>0</b>	<b>0</b>	<b>0</b>	<b>0</b>	<b>1</b>	<b>3</b>	<b>4</b>
<b>Grand Total</b>	<b>2</b>	<b>0</b>	<b>7</b>	<b>0</b>	<b>6</b>	<b>0</b>	<b>0</b>	<b>2</b>	<b>0</b>	<b>7</b>	<b>10</b>	<b>17</b>
Apprch %	100	0		0	100		0	100				
Total %	20	0		0	60		0	20		41.2	58.8	

Start Time	Birch St From North			Pleasant St From East			Pleasant St From West			Int. Total
	Left	Right	App. Total	Thru	Right	App. Total	Left	Thru	App. Total	
Peak Hour Analysis From 04:00 PM to 05:45 PM - Peak 1 of 1										
Peak Hour for Entire Intersection Begins at 04:15 PM										
04:15 PM	0	0	0	0	<b>5</b>	<b>5</b>	0	0	0	<b>5</b>
04:30 PM	0	0	0	0	0	0	0	<b>2</b>	<b>2</b>	2
04:45 PM	0	0	0	0	0	0	0	0	0	0
05:00 PM	0	0	0	0	1	1	0	0	0	1
<b>Total Volume</b>	<b>0</b>	<b>0</b>	<b>0</b>	<b>0</b>	<b>6</b>	<b>6</b>	<b>0</b>	<b>2</b>	<b>2</b>	<b>8</b>
% App. Total	0	0		0	100		0	100		
PHF	.000	.000	.000	.000	.300	.300	.000	.250	.250	.400

# Accurate Counts

978-664-2565

File Name : 202700B7

Site Code : 20270007

Start Date : 10/2/2024

Page No : 11

N/S Street : Birch Street  
 E/W Street : Pleasant Street  
 City/State : Bridgewater, MA  
 Weather : Clear

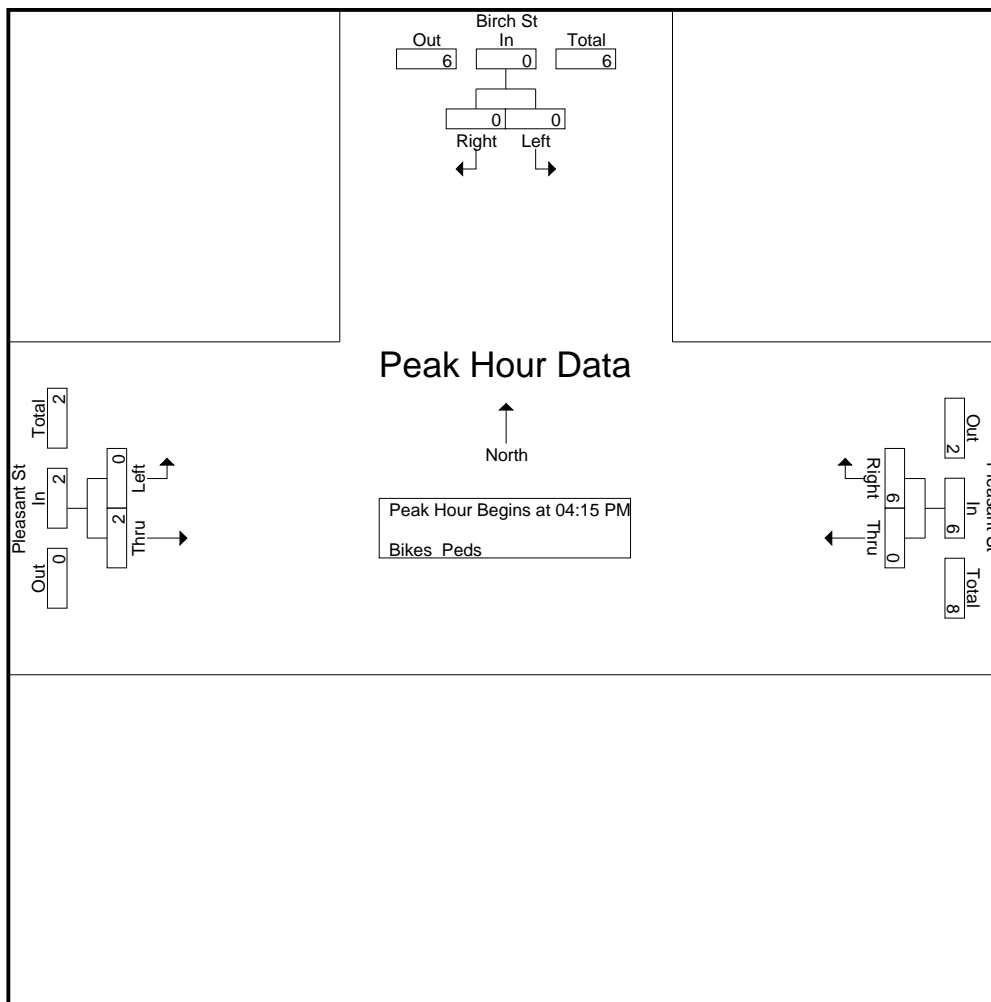

**Peak Hour Analysis From 04:00 PM to 05:45 PM - Peak 1 of 1**

Peak Hour for Each Approach Begins at:

	05:00 PM			04:15 PM			04:00 PM		
+0 mins.	0	0	0	0	5	5	0	0	0
+15 mins.	0	0	0	0	0	0	0	0	0
+30 mins.	0	0	0	0	0	0	0	2	2
+45 mins.	2	0	2	0	1	1	0	0	0
Total Volume	2	0	2	0	6	6	0	2	2
% App. Total	100	0		0	100		0	100	
PHF	.250	.000	.250	.000	.300	.300	.000	.250	.250

# Accurate Counts

978-664-2565

File Name : 202700B7

Site Code : 20270007

Start Date : 10/2/2024

Page No : 12

N/S Street : Birch Street  
E/W Street : Pleasant Street  
City/State : Bridgewater, MA  
Weather : Clear

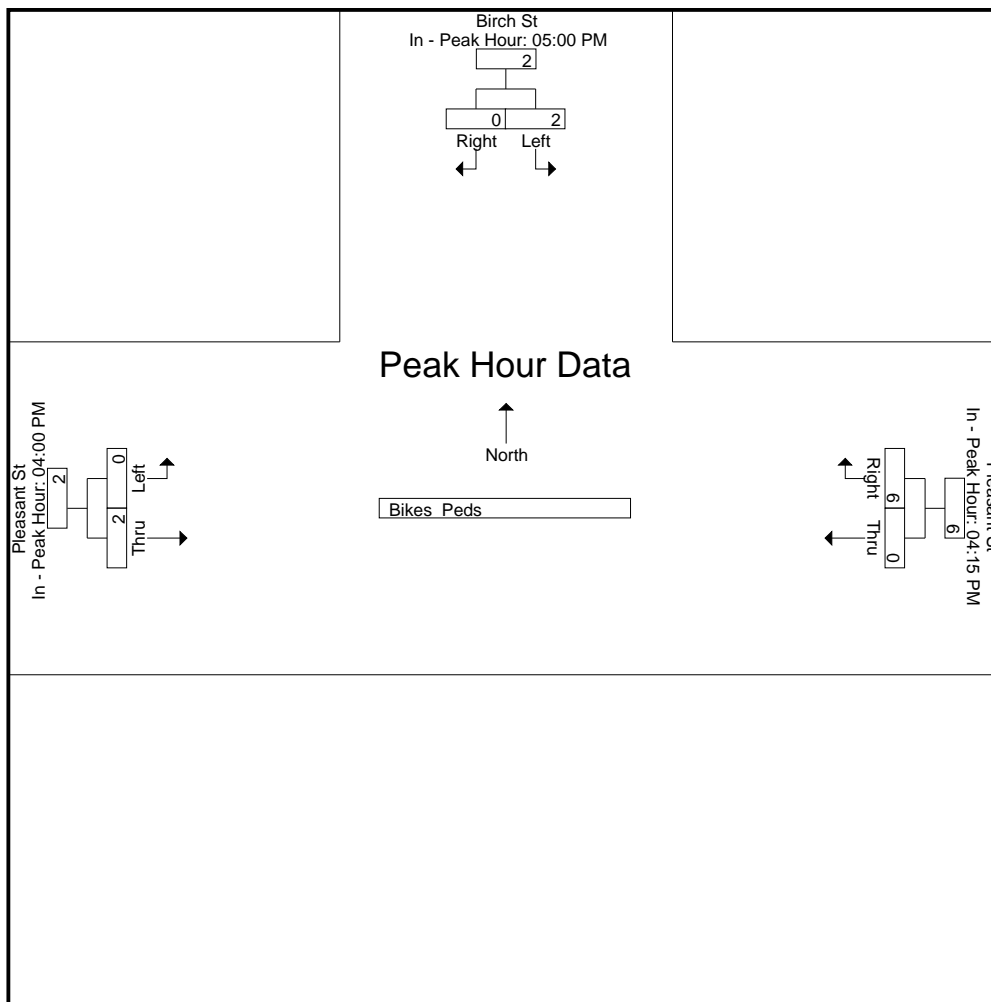



# Accurate Counts

978-664-2565

N/S Street : Center St / Police Station

E/W Street : Pleasant Street

City/State : Bridgewater, MA

Weather : Clear

File Name : 202700B8

Site Code : 20270008

Start Date : 10/2/2024

Page No : 1

### Groups Printed- Cars - Trucks

Start Time	Center St From North			Pleasant St From East			Police Station From South			Pleasant St From West			Int. Total
	Left	Thru	Right	Left	Thru	Right	Left	Thru	Right	Left	Thru	Right	
07:00 AM	9	1	48	0	145	38	0	1	0	94	107	1	444
07:15 AM	25	0	72	0	173	27	0	1	0	50	139	0	487
07:30 AM	7	4	57	0	128	12	1	0	0	68	165	1	443
07:45 AM	8	0	36	0	154	20	0	1	1	68	161	0	449
<b>Total</b>	<b>49</b>	<b>5</b>	<b>213</b>	<b>0</b>	<b>600</b>	<b>97</b>	<b>1</b>	<b>3</b>	<b>1</b>	<b>280</b>	<b>572</b>	<b>2</b>	<b>1823</b>
08:00 AM	7	1	49	1	157	28	4	1	1	81	138	2	470
08:15 AM	14	0	57	0	144	13	0	0	0	63	180	1	472
08:30 AM	8	0	41	0	108	11	0	0	0	40	177	0	385
08:45 AM	16	0	48	0	136	16	1	0	0	49	169	0	435
<b>Total</b>	<b>45</b>	<b>1</b>	<b>195</b>	<b>1</b>	<b>545</b>	<b>68</b>	<b>5</b>	<b>1</b>	<b>1</b>	<b>233</b>	<b>664</b>	<b>3</b>	<b>1762</b>
<b>Grand Total</b>	<b>94</b>	<b>6</b>	<b>408</b>	<b>1</b>	<b>1145</b>	<b>165</b>	<b>6</b>	<b>4</b>	<b>2</b>	<b>513</b>	<b>1236</b>	<b>5</b>	<b>3585</b>
Apprch %	18.5	1.2	80.3	0.1	87.3	12.6	50	33.3	16.7	29.2	70.5	0.3	
Total %	2.6	0.2	11.4	0	31.9	4.6	0.2	0.1	0.1	14.3	34.5	0.1	
Cars	92	6	401	1	1099	151	6	4	2	502	1181	5	3450
% Cars	97.9	100	98.3	100	96	91.5	100	100	100	97.9	95.6	100	96.2
Trucks	2	0	7	0	46	14	0	0	0	11	55	0	135
% Trucks	2.1	0	1.7	0	4	8.5	0	0	0	2.1	4.4	0	3.8

Start Time	Center St From North				Pleasant St From East				Police Station From South				Pleasant St From West				Int. Total
	Left	Thru	Right	App. Total	Left	Thru	Right	App. Total	Left	Thru	Right	App. Total	Left	Thru	Right	App. Total	
Peak Hour Analysis From 07:00 AM to 08:45 AM - Peak 1 of 1																	
Peak Hour for Entire Intersection Begins at 07:15 AM																	
07:15 AM	<b>25</b>	<b>0</b>	<b>72</b>	<b>97</b>	<b>0</b>	<b>173</b>	<b>27</b>	<b>200</b>	<b>0</b>	<b>1</b>	<b>0</b>	<b>1</b>	<b>50</b>	<b>139</b>	<b>0</b>	<b>189</b>	<b>487</b>
07:30 AM	7	4	57	68	0	128	12	140	1	0	0	1	68	165	1	234	443
07:45 AM	8	0	36	44	0	154	20	174	0	1	1	2	68	161	0	229	449
08:00 AM	7	1	49	57	1	157	28	186	4	1	1	6	81	138	2	221	470
<b>Total Volume</b>	<b>47</b>	<b>5</b>	<b>214</b>	<b>266</b>	<b>1</b>	<b>612</b>	<b>87</b>	<b>700</b>	<b>5</b>	<b>3</b>	<b>2</b>	<b>10</b>	<b>267</b>	<b>603</b>	<b>3</b>	<b>873</b>	<b>1849</b>
% App. Total	17.7	1.9	80.5		0.1	87.4	12.4		50	30	20		30.6	69.1	0.3		
PHF	.470	.313	.743	.686	.250	.884	.777	.875	.313	.750	.500	.417	.824	.914	.375	.933	.949
Cars	47	5	214	266	1	591	77	669	5	3	2	10	261	578	3	842	1787
% Cars	100	100	100	100	100	96.6	88.5	95.6	100	100	100	100	97.8	95.9	100	96.4	96.6
Trucks	0	0	0	0	0	21	10	31	0	0	0	0	6	25	0	31	62
% Trucks	0	0	0	0	0	3.4	11.5	4.4	0	0	0	0	2.2	4.1	0	3.6	3.4

# Accurate Counts

978-664-2565

N/S Street : Center St / Police Station  
 E/W Street : Pleasant Street  
 City/State : Bridgewater, MA  
 Weather : Clear

File Name : 202700B8  
 Site Code : 20270008  
 Start Date : 10/2/2024  
 Page No : 2

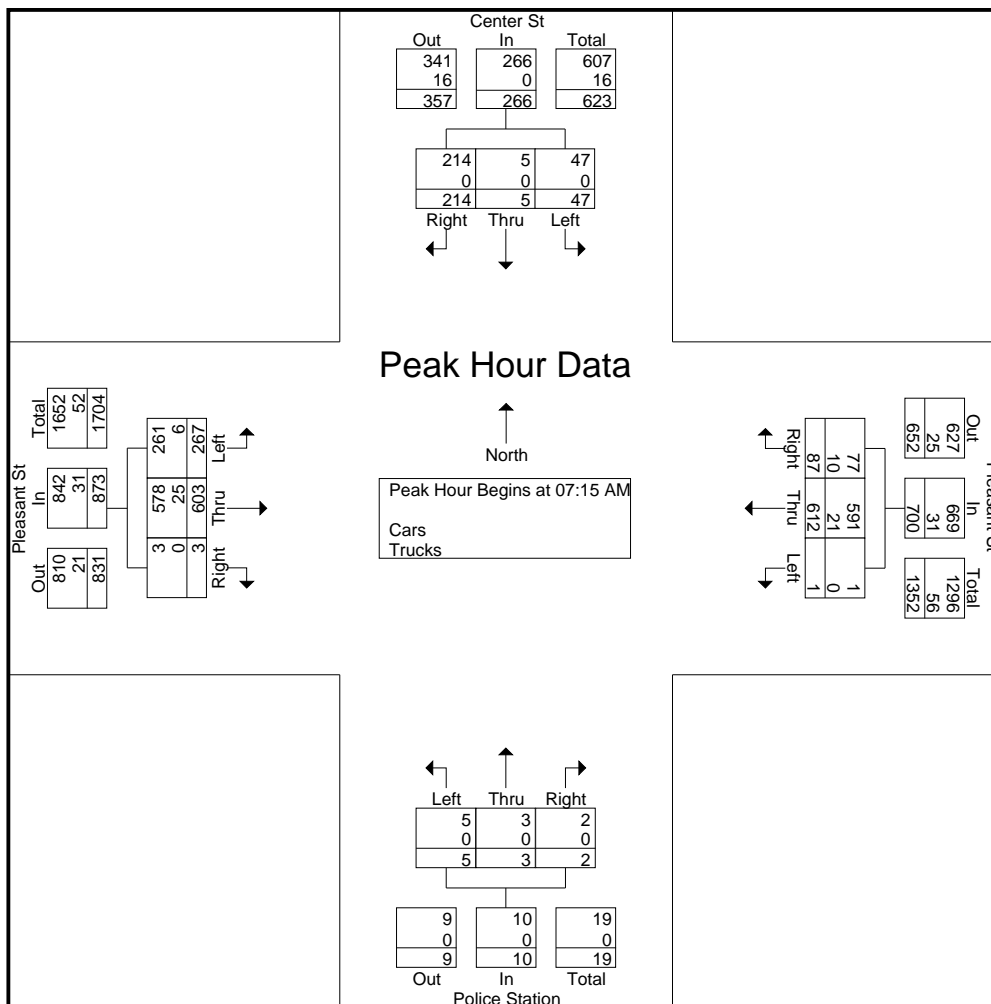

**Peak Hour Analysis From 07:00 AM to 08:45 AM - Peak 1 of 1**

**Peak Hour for Each Approach Begins at:**

	07:00 AM				07:15 AM				07:15 AM				07:30 AM			
+0 mins.	9	1	48	58	0	<b>173</b>	27	<b>200</b>	0	<b>1</b>	0	<b>1</b>	68	165	1	234
+15 mins.	<b>25</b>	0	<b>72</b>	<b>97</b>	0	128	12	140	1	0	0	1	68	161	0	229
+30 mins.	7	<b>4</b>	57	68	0	154	20	174	0	1	<b>1</b>	<b>2</b>	<b>81</b>	138	<b>2</b>	221
+45 mins.	8	0	36	44	<b>1</b>	157	<b>28</b>	186	<b>4</b>	1	1	<b>6</b>	<b>63</b>	<b>180</b>	<b>1</b>	<b>244</b>
Total Volume	49	5	213	267	1	612	87	700	5	3	2	10	280	644	4	928
% App. Total	18.4	1.9	79.8		0.1	87.4	12.4		50	30	20		30.2	69.4	0.4	
PHF	.490	.313	.740	.688	.250	.884	.777	.875	.313	.750	.500	.417	.864	.894	.500	.951
Cars	49	5	213	267	1	591	77	669	5	3	2	10	274	617	4	895
% Cars	100	100	100	100	100	96.6	88.5	95.6	100	100	100	100	97.9	95.8	100	96.4
Trucks	0	0	0	0	0	21	10	31	0	0	0	0	6	27	0	33
% Trucks	0	0	0	0	0	3.4	11.5	4.4	0	0	0	0	2.1	4.2	0	3.6

# Accurate Counts

978-664-2565

N/S Street : Center St / Police Station  
 E/W Street : Pleasant Street  
 City/State : Bridgewater, MA  
 Weather : Clear

File Name : 202700B8  
 Site Code : 20270008  
 Start Date : 10/2/2024  
 Page No : 3

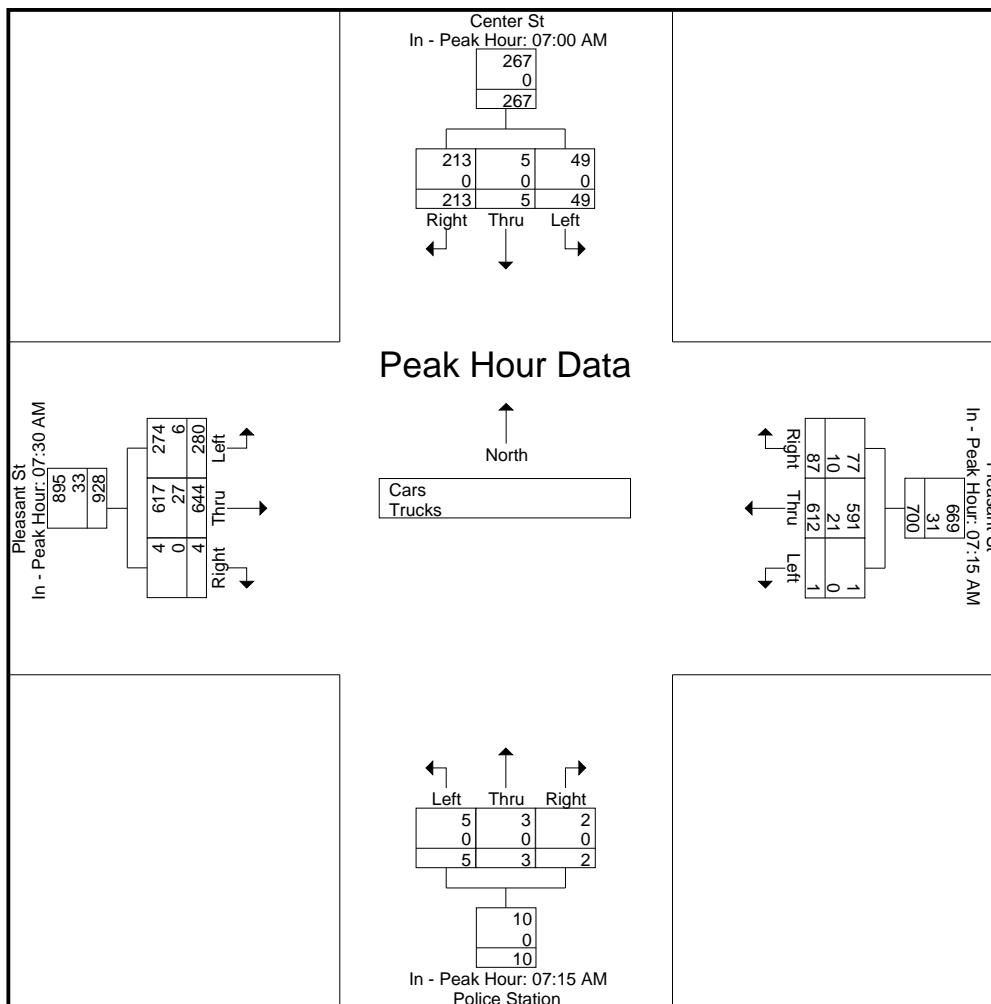

# Accurate Counts

978-664-2565

N/S Street : Center St / Police Station  
 E/W Street : Pleasant Street  
 City/State : Bridgewater, MA  
 Weather : Clear

File Name : 202700B8  
 Site Code : 20270008  
 Start Date : 10/2/2024  
 Page No : 4

## Groups Printed- Cars

Start Time	Center St From North			Pleasant St From East			Police Station From South			Pleasant St From West			Int. Total
	Left	Thru	Right	Left	Thru	Right	Left	Thru	Right	Left	Thru	Right	
07:00 AM	9	1	48	0	137	36	0	1	0	93	100	1	426
07:15 AM	25	0	72	0	171	26	0	1	0	49	133	0	477
07:30 AM	7	4	57	0	123	12	1	0	0	68	156	1	429
07:45 AM	8	0	36	0	143	20	0	1	1	68	156	0	433
<b>Total</b>	<b>49</b>	<b>5</b>	<b>213</b>	<b>0</b>	<b>574</b>	<b>94</b>	<b>1</b>	<b>3</b>	<b>1</b>	<b>278</b>	<b>545</b>	<b>2</b>	<b>1765</b>
08:00 AM	7	1	49	1	154	19	4	1	1	76	133	2	448
08:15 AM	13	0	52	0	135	11	0	0	0	62	172	1	446
08:30 AM	8	0	39	0	101	11	0	0	0	38	169	0	366
08:45 AM	15	0	48	0	135	16	1	0	0	48	162	0	425
<b>Total</b>	<b>43</b>	<b>1</b>	<b>188</b>	<b>1</b>	<b>525</b>	<b>57</b>	<b>5</b>	<b>1</b>	<b>1</b>	<b>224</b>	<b>636</b>	<b>3</b>	<b>1685</b>
<b>Grand Total</b>	<b>92</b>	<b>6</b>	<b>401</b>	<b>1</b>	<b>1099</b>	<b>151</b>	<b>6</b>	<b>4</b>	<b>2</b>	<b>502</b>	<b>1181</b>	<b>5</b>	<b>3450</b>
Apprch %	18.4	1.2	80.4	0.1	87.8	12.1	50	33.3	16.7	29.7	70	0.3	
Total %	2.7	0.2	11.6	0	31.9	4.4	0.2	0.1	0.1	14.6	34.2	0.1	

Start Time	Center St From North				Pleasant St From East				Police Station From South				Pleasant St From West				Int. Total
	Left	Thru	Right	App. Total	Left	Thru	Right	App. Total	Left	Thru	Right	App. Total	Left	Thru	Right	App. Total	
<b>Peak Hour Analysis From 07:00 AM to 08:45 AM - Peak 1 of 1</b>																	
<b>Peak Hour for Entire Intersection Begins at 07:15 AM</b>																	
07:15 AM	<b>25</b>	0	<b>72</b>	<b>97</b>	0	<b>171</b>	<b>26</b>	<b>197</b>	0	<b>1</b>	0	1	49	133	0	182	<b>477</b>
07:30 AM	7	4	57	68	0	123	12	135	1	0	0	1	68	<b>156</b>	1	<b>225</b>	429
07:45 AM	8	0	36	44	0	143	20	163	0	1	1	2	68	156	0	224	433
08:00 AM	7	1	49	57	<b>1</b>	154	19	174	<b>4</b>	1	1	<b>6</b>	<b>76</b>	133	<b>2</b>	211	448
Total Volume	47	5	214	266	1	591	77	669	5	3	2	10	261	578	3	842	1787
% App. Total	17.7	1.9	80.5		0.1	88.3	11.5		50	30	20		31	68.6	0.4		
PHF	.470	.313	.743	.686	.250	.864	.740	.849	.313	.750	.500	.417	.859	.926	.375	.936	.937

# Accurate Counts

978-664-2565

N/S Street : Center St / Police Station

E/W Street : Pleasant Street

City/State : Bridgewater, MA

Weather : Clear

File Name : 202700B8

Site Code : 20270008

Start Date : 10/2/2024

Page No : 5

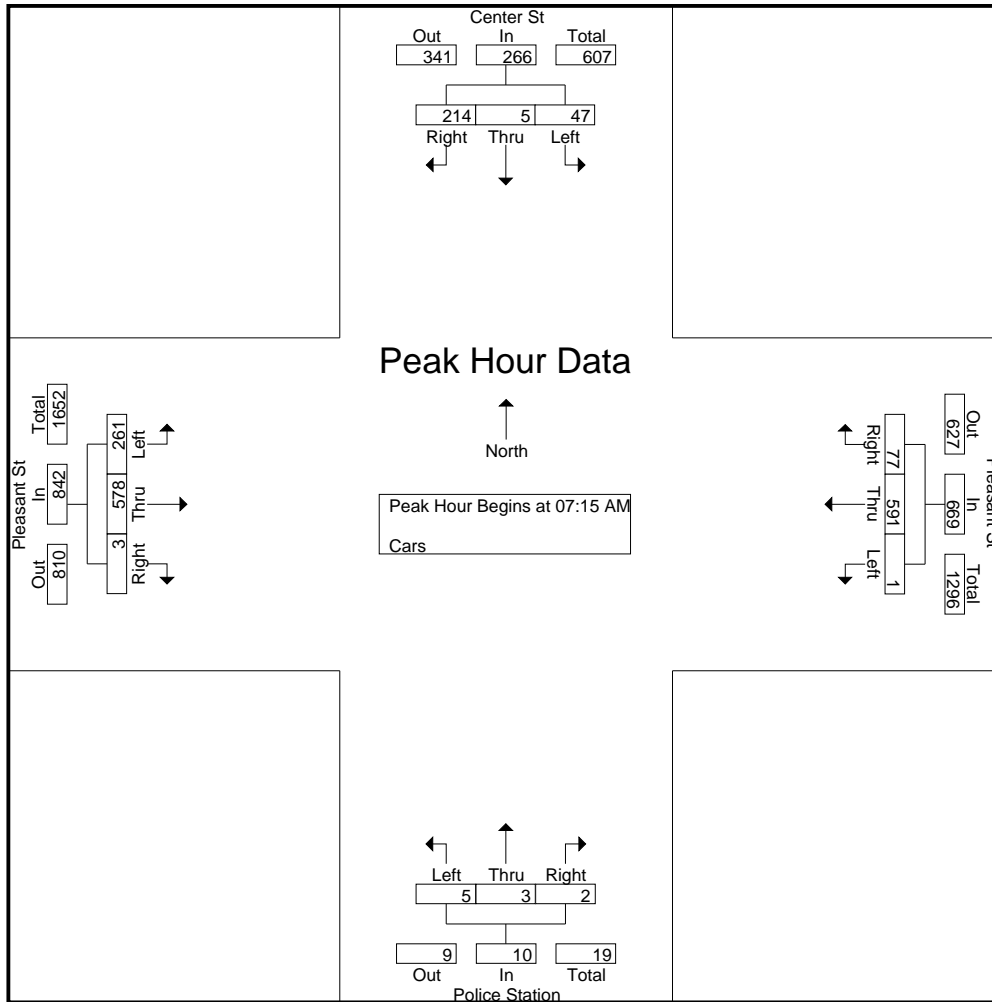

**Peak Hour Analysis From 07:00 AM to 08:45 AM - Peak 1 of 1**

**Peak Hour for Each Approach Begins at:**

	07:00 AM				07:15 AM				07:15 AM				07:30 AM			
+0 mins.	9	1	48	58	0	<b>171</b>	<b>26</b>	<b>197</b>	0	<b>1</b>	0	1	68	156	1	225
+15 mins.	<b>25</b>	0	<b>72</b>	<b>97</b>	0	123	12	135	1	0	0	1	68	156	0	224
+30 mins.	7	<b>4</b>	57	68	0	143	20	163	0	1	<b>1</b>	2	<b>76</b>	133	<b>2</b>	211
+45 mins.	8	0	36	44	<b>1</b>	154	19	174	<b>4</b>	1	1	<b>6</b>	<b>62</b>	<b>172</b>	1	<b>235</b>
Total Volume	49	5	213	267	1	591	77	669	5	3	2	10	274	617	4	895
% App. Total	18.4	1.9	79.8		0.1	88.3	11.5		50	30	20		30.6	68.9	0.4	
PHF	.490	.313	.740	.688	.250	.864	.740	.849	.313	.750	.500	.417	.901	.897	.500	.952

# Accurate Counts

978-664-2565

File Name : 202700B8

Site Code : 20270008

Start Date : 10/2/2024

Page No : 6

N/S Street : Center St / Police Station

E/W Street : Pleasant Street

City/State : Bridgewater, MA

Weather : Clear

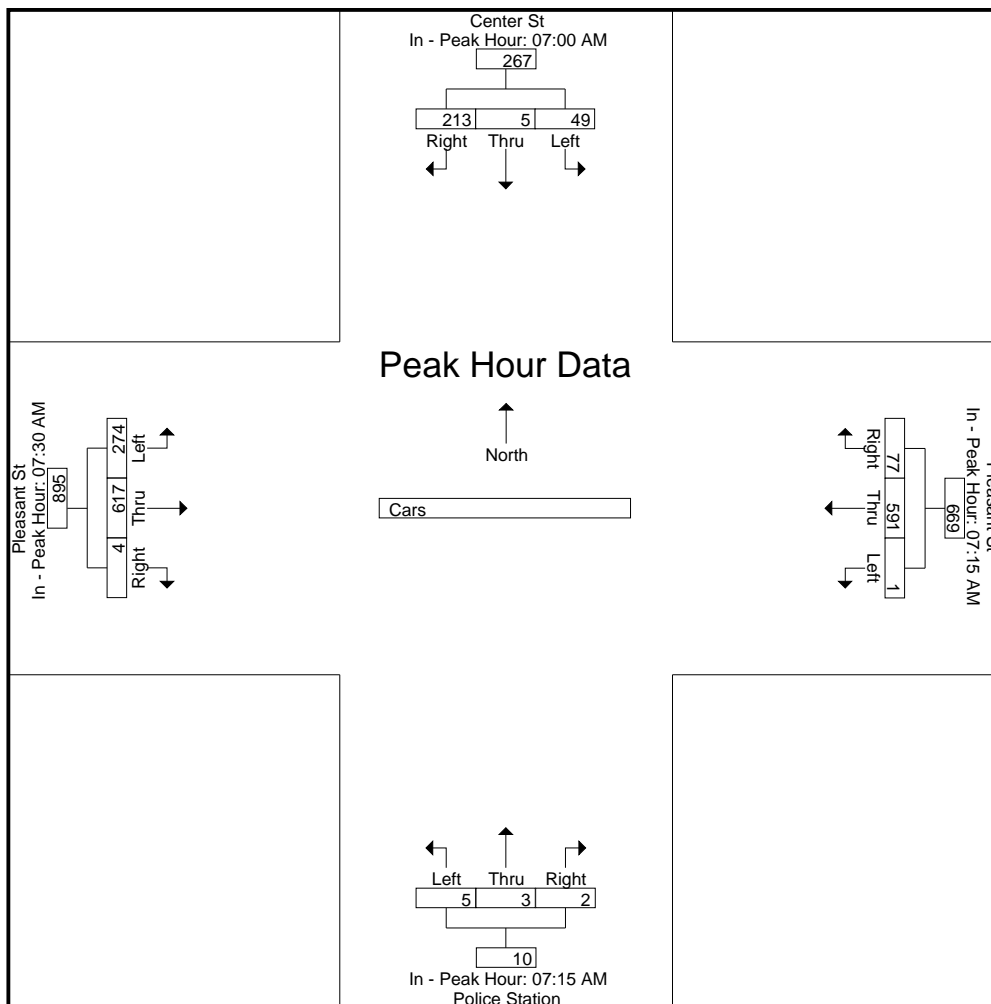

# Accurate Counts

978-664-2565

N/S Street : Center St / Police Station

E/W Street : Pleasant Street

City/State : Bridgewater, MA

Weather : Clear

File Name : 202700B8

Site Code : 20270008

Start Date : 10/2/2024

Page No : 7

## Groups Printed- Trucks

Start Time	Center St From North			Pleasant St From East			Police Station From South			Pleasant St From West			Int. Total
	Left	Thru	Right	Left	Thru	Right	Left	Thru	Right	Left	Thru	Right	
07:00 AM	0	0	0	0	8	2	0	0	0	1	7	0	18
07:15 AM	0	0	0	0	2	1	0	0	0	1	6	0	10
07:30 AM	0	0	0	0	5	0	0	0	0	0	9	0	14
07:45 AM	0	0	0	0	11	0	0	0	0	0	5	0	16
<b>Total</b>	0	0	0	0	26	3	0	0	0	2	27	0	58
08:00 AM	0	0	0	0	3	9	0	0	0	5	5	0	22
08:15 AM	1	0	5	0	9	2	0	0	0	1	8	0	26
08:30 AM	0	0	2	0	7	0	0	0	0	2	8	0	19
08:45 AM	1	0	0	0	1	0	0	0	0	1	7	0	10
<b>Total</b>	2	0	7	0	20	11	0	0	0	9	28	0	77
<b>Grand Total</b>	2	0	7	0	46	14	0	0	0	11	55	0	135
Apprch %	22.2	0	77.8	0	76.7	23.3	0	0	0	16.7	83.3	0	
Total %	1.5	0	5.2	0	34.1	10.4	0	0	0	8.1	40.7	0	

Start Time	Center St From North				Pleasant St From East				Police Station From South				Pleasant St From West				Int. Total
	Left	Thru	Right	App. Total	Left	Thru	Right	App. Total	Left	Thru	Right	App. Total	Left	Thru	Right	App. Total	
<b>Peak Hour Analysis From 07:00 AM to 08:45 AM - Peak 1 of 1</b>																	
<b>Peak Hour for Entire Intersection Begins at 07:45 AM</b>																	
07:45 AM	0	0	0	0	0	11	0	11	0	0	0	0	0	5	0	5	16
08:00 AM	0	0	0	0	0	3	9	12	0	0	0	0	5	5	0	10	22
08:15 AM	1	0	5	6	0	9	2	11	0	0	0	0	1	8	0	9	26
08:30 AM	0	0	2	2	0	7	0	7	0	0	0	0	2	8	0	10	19
<b>Total Volume</b>	1	0	7	8	0	30	11	41	0	0	0	0	8	26	0	34	83
<b>% App. Total</b>	12.5	0	87.5		0	73.2	26.8		0	0	0		23.5	76.5	0		
PHF	.250	.000	.350	.333	.000	.682	.306	.854	.000	.000	.000	.000	.400	.813	.000	.850	.798

# Accurate Counts

978-664-2565

N/S Street : Center St / Police Station

E/W Street : Pleasant Street

City/State : Bridgewater, MA

Weather : Clear

File Name : 202700B8

Site Code : 20270008

Start Date : 10/2/2024

Page No : 8

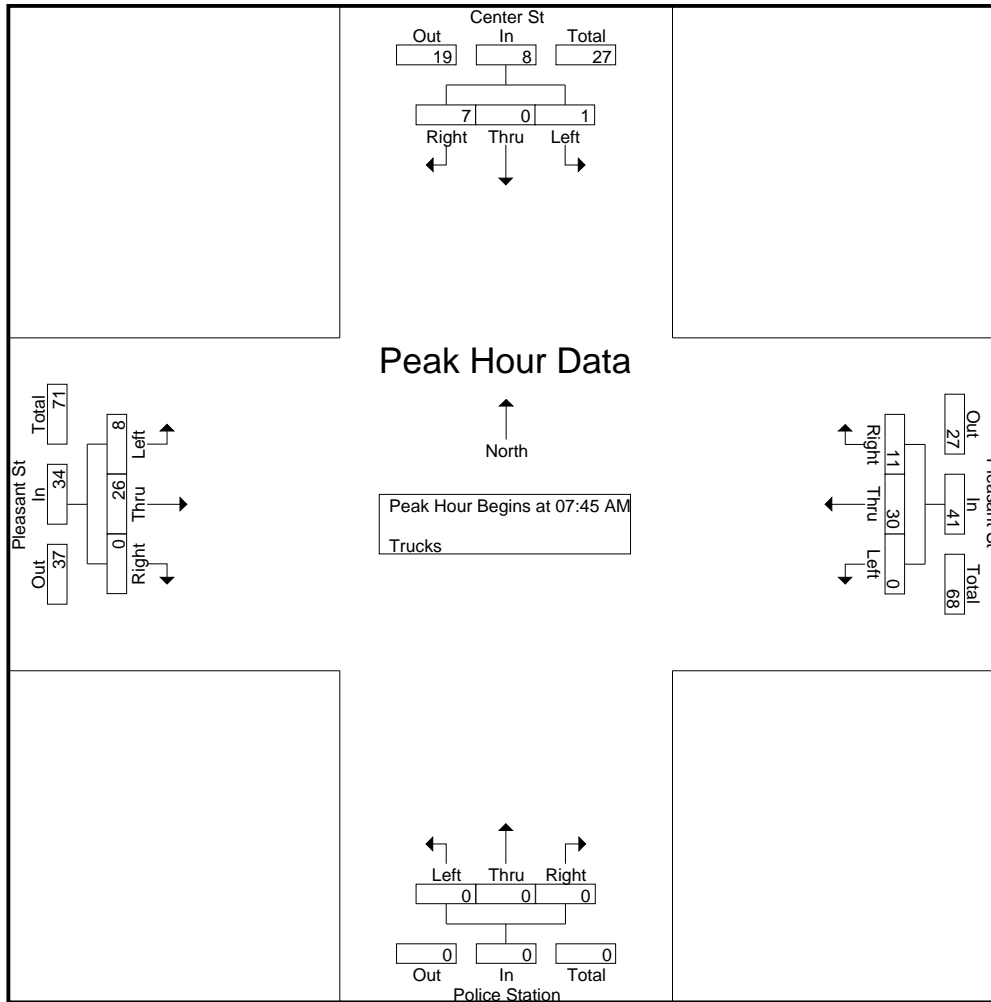

**Peak Hour Analysis From 07:00 AM to 08:45 AM - Peak 1 of 1**

**Peak Hour for Each Approach Begins at:**

	08:00 AM				07:45 AM				07:00 AM				08:00 AM			
+0 mins.	0	0	0	0	0	<b>11</b>	0	11	0	0	0	0	<b>5</b>	5	0	<b>10</b>
+15 mins.	<b>1</b>	0	<b>5</b>	<b>6</b>	0	3	<b>9</b>	<b>12</b>	0	0	0	0	1	<b>8</b>	0	9
+30 mins.	0	0	2	2	0	9	2	11	0	0	0	0	2	8	0	10
+45 mins.	1	0	0	1	0	7	0	7	0	0	0	0	1	7	0	8
<b>Total Volume</b>	2	0	7	9	0	30	11	41	0	0	0	0	9	28	0	37
<b>% App. Total</b>	22.2	0	77.8		0	73.2	26.8		0	0	0		24.3	75.7	0	
<b>PHF</b>	.500	.000	.350	.375	.000	.682	.306	.854	.000	.000	.000	.000	.450	.875	.000	.925



# Accurate Counts

978-664-2565

File Name : 202700B8

Site Code : 20270008

Start Date : 10/2/2024

Page No : 9

N/S Street : Center St / Police Station

E/W Street : Pleasant Street

City/State : Bridgewater, MA

Weather : Clear

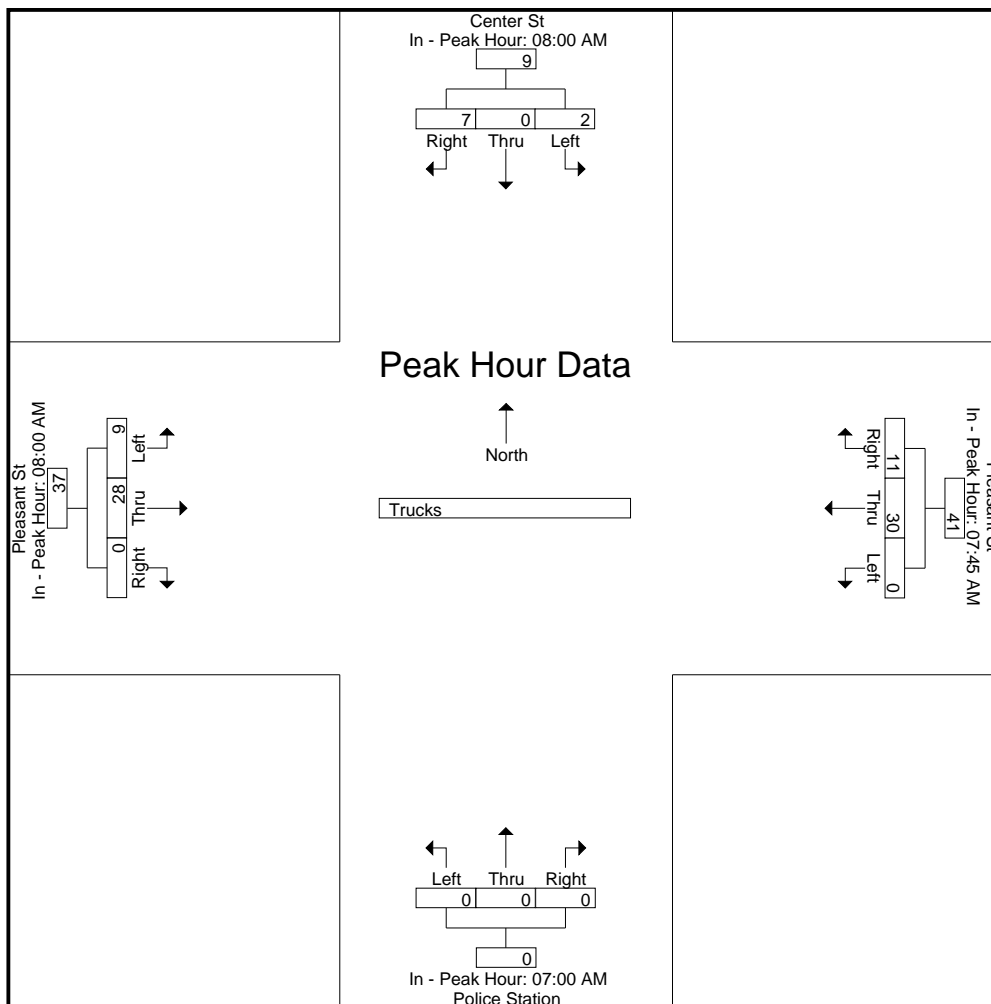

# Accurate Counts

978-664-2565

N/S Street : Center St / Police Station

E/W Street : Pleasant Street

City/State : Bridgewater, MA

Weather : Clear

File Name : 202700B8

Site Code : 20270008

Start Date : 10/2/2024

Page No : 10

## Groups Printed- Bikes Peds

Start Time	Center St From North				Pleasant St From East				Police Station From South				Pleasant St From West				Exclu. Total	Inclu. Total	Int. Total
	Left	Thru	Right	Peds	Left	Thru	Right	Peds	Left	Thru	Right	Peds	Left	Thru	Right	Peds			
07:00 AM	0	0	0	0	0	0	0	1	0	0	0	0	0	0	0	0	1	0	1
07:15 AM	0	0	0	0	0	0	0	0	0	0	0	0	0	0	0	0	0	0	0
07:30 AM	0	0	0	0	0	0	0	0	0	0	0	0	0	0	0	0	0	0	0
07:45 AM	0	0	0	5	0	0	0	1	0	0	0	0	0	0	0	0	6	0	6
<b>Total</b>	0	0	0	5	0	0	0	2	0	0	0	0	0	0	0	0	7	0	7
08:00 AM	0	0	0	0	0	0	0	0	0	0	0	0	1	0	0	0	0	1	1
08:15 AM	0	0	0	0	0	0	0	0	0	0	0	0	0	0	0	0	0	0	0
08:30 AM	0	0	0	1	0	0	0	0	0	0	0	0	0	0	0	0	1	0	1
08:45 AM	0	0	0	0	0	0	0	0	0	0	0	0	0	0	0	0	0	0	0
<b>Total</b>	0	0	0	1	0	0	0	0	0	0	0	0	1	0	0	0	1	1	2
<b>Grand Total</b>	0	0	0	6	0	0	0	2	0	0	0	0	1	0	0	0	8	1	9
Apprch %	0	0	0		0	0	0		0	0	0		100	0	0				
Total %	0	0	0		0	0	0		0	0	0		100	0	0		88.9	11.1	

Start Time	Center St From North				Pleasant St From East				Police Station From South				Pleasant St From West				Int. Total
	Left	Thru	Right	App. Total	Left	Thru	Right	App. Total	Left	Thru	Right	App. Total	Left	Thru	Right	App. Total	
<b>Peak Hour Analysis From 07:00 AM to 08:45 AM - Peak 1 of 1</b>																	
<b>Peak Hour for Entire Intersection Begins at 07:15 AM</b>																	
07:15 AM	0	0	0	0	0	0	0	0	0	0	0	0	0	0	0	0	0
07:30 AM	0	0	0	0	0	0	0	0	0	0	0	0	0	0	0	0	0
07:45 AM	0	0	0	0	0	0	0	0	0	0	0	0	0	0	0	0	0
08:00 AM	0	0	0	0	0	0	0	0	0	0	0	0	1	0	0	1	1
<b>Total Volume</b>	0	0	0	0	0	0	0	0	0	0	0	0	1	0	0	1	1
<b>% App. Total</b>	0	0	0		0	0	0		0	0	0		100	0	0		
PHF	.000	.000	.000	.000	.000	.000	.000	.000	.000	.000	.000	.000	.250	.000	.000	.250	.250

# Accurate Counts

978-664-2565

N/S Street : Center St / Police Station  
 E/W Street : Pleasant Street  
 City/State : Bridgewater, MA  
 Weather : Clear

File Name : 202700B8  
 Site Code : 20270008  
 Start Date : 10/2/2024  
 Page No : 11

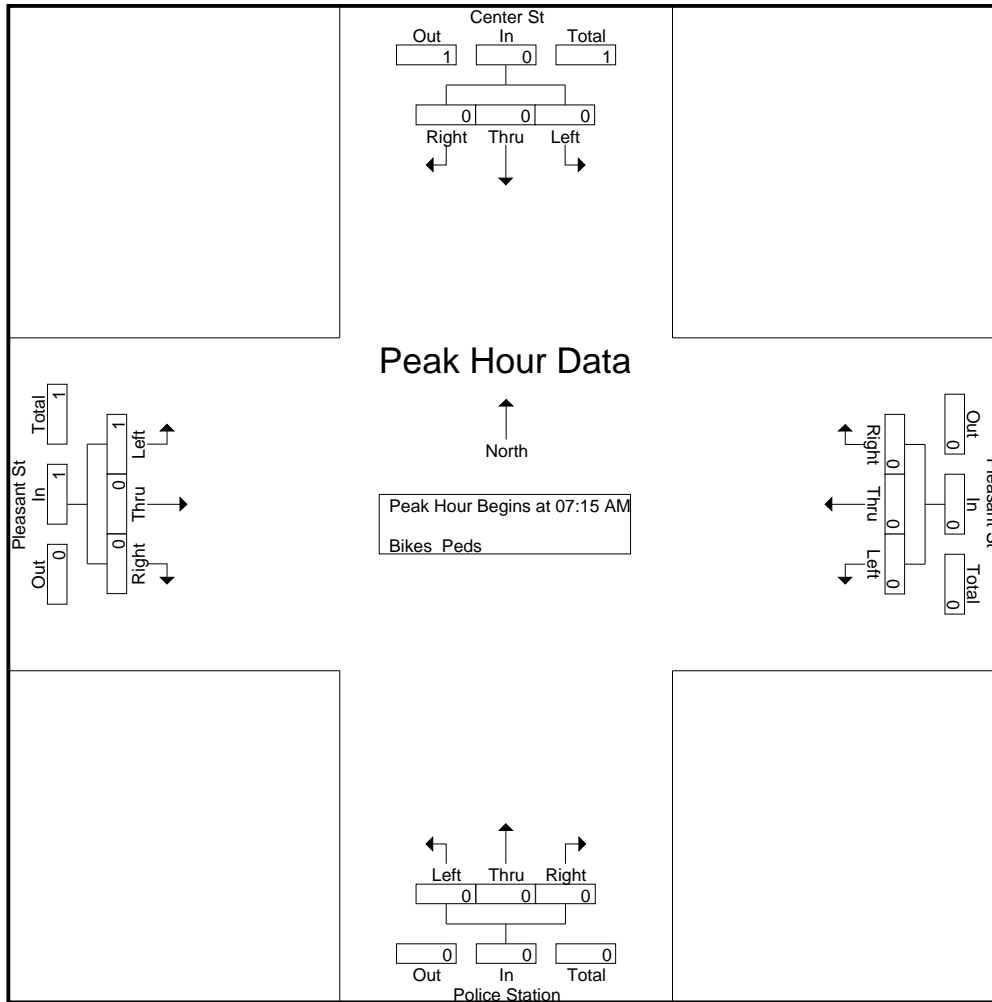

**Peak Hour Analysis From 07:00 AM to 08:45 AM - Peak 1 of 1**

**Peak Hour for Each Approach Begins at:**

	07:00 AM				07:00 AM				07:00 AM				07:15 AM			
+0 mins.	0	0	0	0	0	0	0	0	0	0	0	0	0	0	0	0
+15 mins.	0	0	0	0	0	0	0	0	0	0	0	0	0	0	0	0
+30 mins.	0	0	0	0	0	0	0	0	0	0	0	0	0	0	0	0
+45 mins.	0	0	0	0	0	0	0	0	0	0	0	0	1	0	0	1
Total Volume	0	0	0	0	0	0	0	0	0	0	0	0	1	0	0	1
% App. Total	0	0	0	0	0	0	0	0	0	0	0	0	100	0	0	100
PHF	.000	.000	.000	.000	.000	.000	.000	.000	.000	.000	.000	.000	.250	.000	.000	.250

# Accurate Counts

978-664-2565

N/S Street : Center St / Police Station

E/W Street : Pleasant Street

City/State : Bridgewater, MA

Weather : Clear

File Name : 202700B8

Site Code : 20270008

Start Date : 10/2/2024

Page No : 12

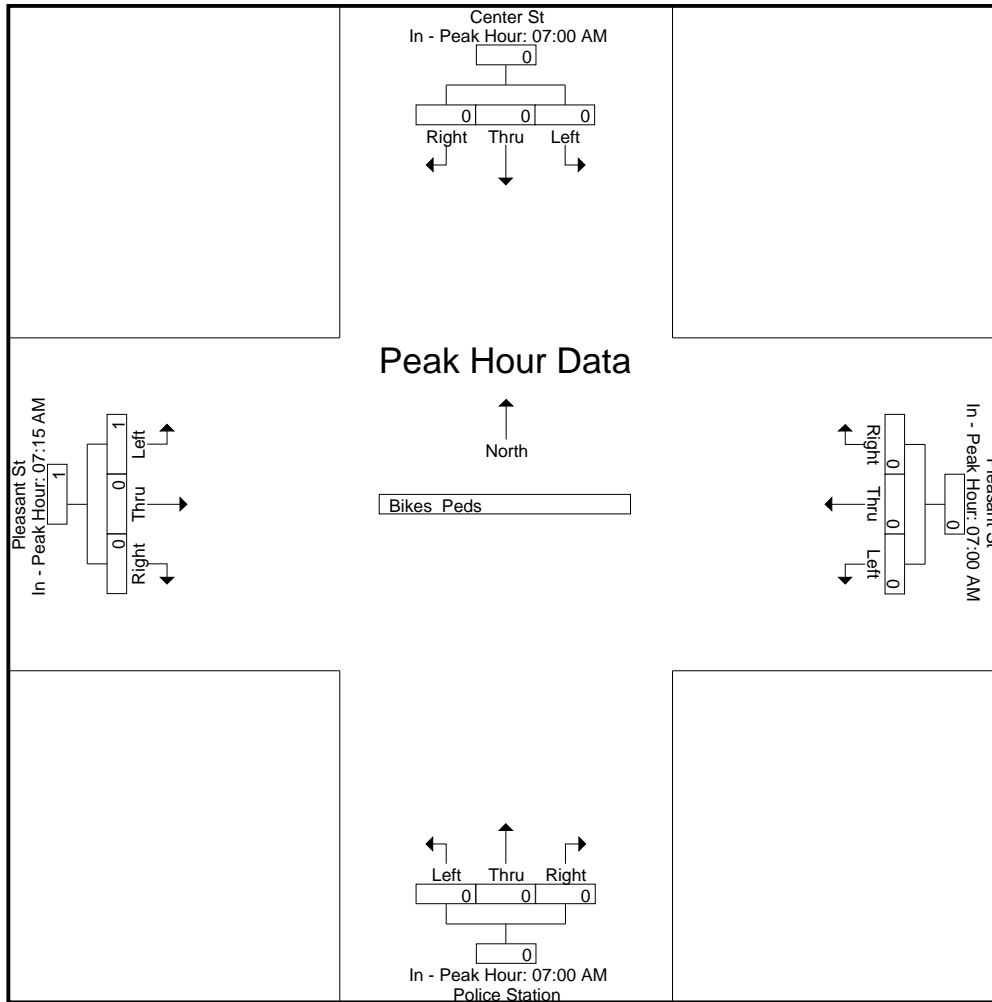

# Accurate Counts

978-664-2565

N/S Street : Center St / Police Station

E/W Street : Pleasant Street

City/State : Bridgewater, MA

Weather : Clear

File Name : 202700B8

Site Code : 20270008

Start Date : 10/2/2024

Page No : 1

### Groups Printed- Cars - Trucks

Start Time	Center St From North			Pleasant St From East			Police Station From South			Pleasant St From West			Int. Total
	Left	Thru	Right	Left	Thru	Right	Left	Thru	Right	Left	Thru	Right	
04:00 PM	15	0	66	1	177	12	0	0	2	71	160	0	504
04:15 PM	10	0	70	0	163	12	1	0	2	62	152	0	472
04:30 PM	13	0	69	0	164	18	1	1	0	58	149	0	473
04:45 PM	13	1	69	0	141	18	2	1	0	77	142	1	465
<b>Total</b>	<b>51</b>	<b>1</b>	<b>274</b>	<b>1</b>	<b>645</b>	<b>60</b>	<b>4</b>	<b>2</b>	<b>4</b>	<b>268</b>	<b>603</b>	<b>1</b>	<b>1914</b>
05:00 PM	19	0	80	0	144	9	0	0	1	75	156	0	484
05:15 PM	24	0	68	1	151	13	0	0	1	63	169	2	492
05:30 PM	14	1	73	0	140	9	1	2	0	70	156	1	467
05:45 PM	10	0	69	2	111	14	1	2	1	71	149	0	430
<b>Total</b>	<b>67</b>	<b>1</b>	<b>290</b>	<b>3</b>	<b>546</b>	<b>45</b>	<b>2</b>	<b>4</b>	<b>3</b>	<b>279</b>	<b>630</b>	<b>3</b>	<b>1873</b>
<b>Grand Total</b>	<b>118</b>	<b>2</b>	<b>564</b>	<b>4</b>	<b>1191</b>	<b>105</b>	<b>6</b>	<b>6</b>	<b>7</b>	<b>547</b>	<b>1233</b>	<b>4</b>	<b>3787</b>
Apprch %	17.3	0.3	82.5	0.3	91.6	8.1	31.6	31.6	36.8	30.7	69.1	0.2	
Total %	3.1	0.1	14.9	0.1	31.4	2.8	0.2	0.2	0.2	14.4	32.6	0.1	
Cars	118	2	564	4	1176	105	6	6	7	543	1204	4	3739
% Cars	100	100	100	100	98.7	100	100	100	100	99.3	97.6	100	98.7
Trucks	0	0	0	0	15	0	0	0	0	4	29	0	48
% Trucks	0	0	0	0	1.3	0	0	0	0	0.7	2.4	0	1.3

Start Time	Center St From North				Pleasant St From East				Police Station From South				Pleasant St From West				Int. Total
	Left	Thru	Right	App. Total	Left	Thru	Right	App. Total	Left	Thru	Right	App. Total	Left	Thru	Right	App. Total	
Peak Hour Analysis From 04:00 PM to 05:45 PM - Peak 1 of 1																	
Peak Hour for Entire Intersection Begins at 04:00 PM																	
04:00 PM	<b>15</b>	0	66	81	<b>1</b>	<b>177</b>	12	<b>190</b>	0	0	<b>2</b>	2	71	<b>160</b>	0	<b>231</b>	<b>504</b>
04:15 PM	10	0	<b>70</b>	80	0	163	12	175	1	0	2	<b>3</b>	62	152	0	214	472
04:30 PM	13	0	69	82	0	164	<b>18</b>	182	1	<b>1</b>	0	2	58	149	0	207	473
04:45 PM	13	<b>1</b>	69	<b>83</b>	0	141	18	159	<b>2</b>	1	0	<b>3</b>	<b>77</b>	142	<b>1</b>	220	465
<b>Total Volume</b>	<b>51</b>	<b>1</b>	<b>274</b>	<b>326</b>	<b>1</b>	<b>645</b>	<b>60</b>	<b>706</b>	<b>4</b>	<b>2</b>	<b>4</b>	<b>10</b>	<b>268</b>	<b>603</b>	<b>1</b>	<b>872</b>	<b>1914</b>
% App. Total	15.6	0.3	84		0.1	91.4	8.5		40	20	40		30.7	69.2	0.1		
PHF	.850	.250	.979	.982	.250	.911	.833	.929	.500	.500	.500	.833	.870	.942	.250	.944	.949
Cars	51	1	274	326	1	632	60	693	4	2	4	10	266	582	1	849	1878
% Cars	100	100	100	100	100	98.0	100	98.2	100	100	100	100	99.3	96.5	100	97.4	98.1
Trucks	0	0	0	0	0	13	0	13	0	0	0	0	2	21	0	23	36
% Trucks	0	0	0	0	0	2.0	0	1.8	0	0	0	0	0.7	3.5	0	2.6	1.9

# Accurate Counts

978-664-2565

N/S Street : Center St / Police Station

E/W Street : Pleasant Street

City/State : Bridgewater, MA

Weather : Clear

File Name : 202700B8

Site Code : 20270008

Start Date : 10/2/2024

Page No : 2

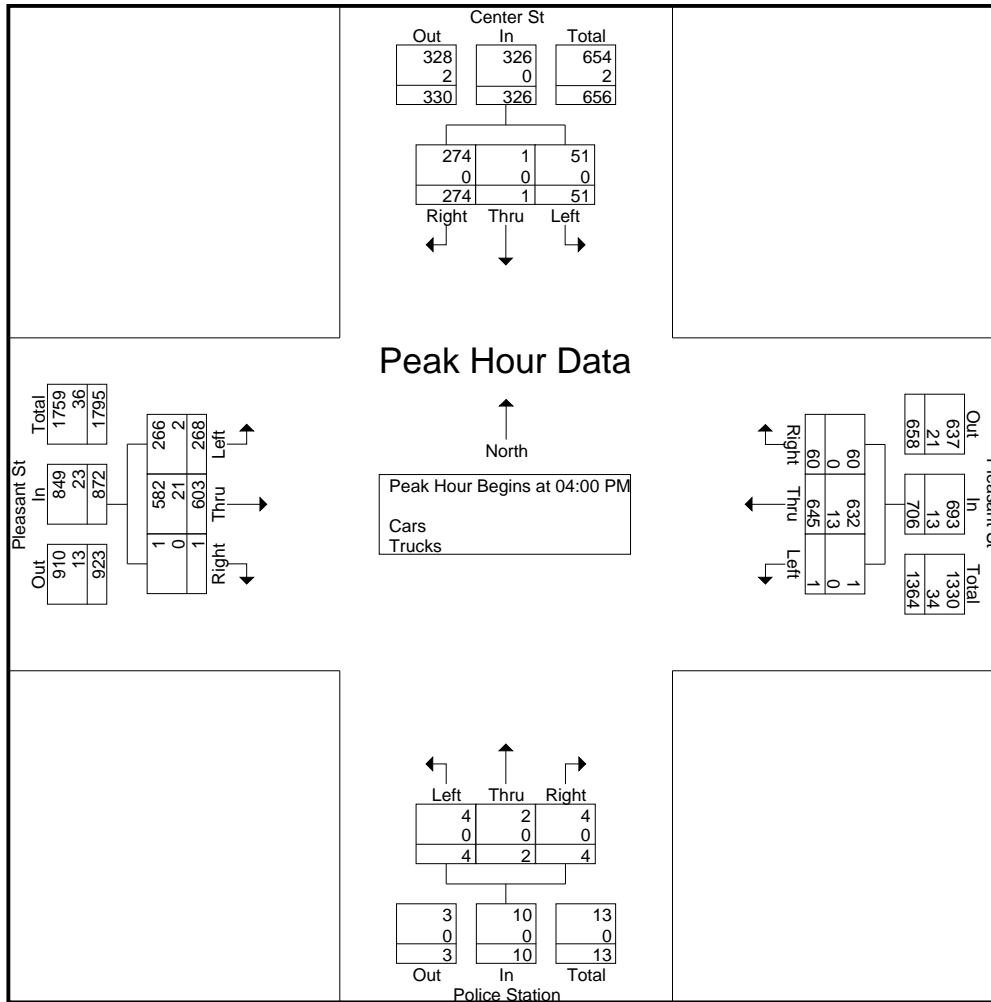

**Peak Hour Analysis From 04:00 PM to 05:45 PM - Peak 1 of 1**

**Peak Hour for Each Approach Begins at:**

	04:45 PM				04:00 PM				04:00 PM				04:45 PM			
+0 mins.	13	1	69	83	1	177	12	190	0	0	2	2	77	142	1	220
+15 mins.	19	0	80	99	0	163	12	175	1	0	2	3	75	156	0	231
+30 mins.	24	0	68	92	0	164	18	182	1	1	0	2	63	169	2	234
+45 mins.	14	1	73	88	0	141	18	159	2	1	0	3	70	156	1	227
Total Volume	70	2	290	362	1	645	60	706	4	2	4	10	285	623	4	912
% App. Total	19.3	0.6	80.1		0.1	91.4	8.5		40	20	40		31.2	68.3	0.4	
PHF	.729	.500	.906	.914	.250	.911	.833	.929	.500	.500	.500	.833	.925	.922	.500	.974
Cars	70	2	290	362	1	632	60	693	4	2	4	10	284	614	4	902
% Cars	100	100	100	100	100	98	100	98.2	100	100	100	100	99.6	98.6	100	98.9
Trucks	0	0	0	0	0	13	0	13	0	0	0	0	1	9	0	10
% Trucks	0	0	0	0	0	2	0	1.8	0	0	0	0	0.4	1.4	0	1.1

# Accurate Counts

978-664-2565

N/S Street : Center St / Police Station  
 E/W Street : Pleasant Street  
 City/State : Bridgewater, MA  
 Weather : Clear

File Name : 202700B8  
 Site Code : 20270008  
 Start Date : 10/2/2024  
 Page No : 3

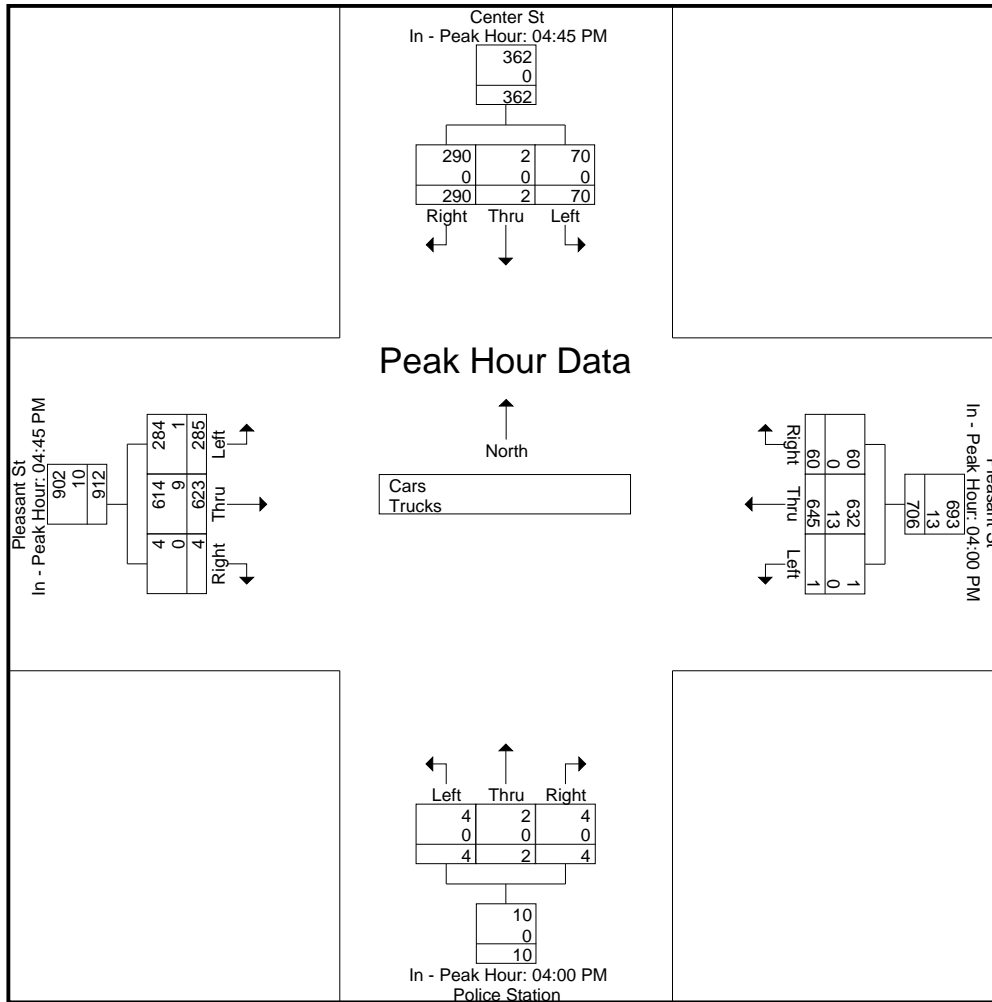

# Accurate Counts

978-664-2565

N/S Street : Center St / Police Station  
 E/W Street : Pleasant Street  
 City/State : Bridgewater, MA  
 Weather : Clear

File Name : 202700B8  
 Site Code : 20270008  
 Start Date : 10/2/2024  
 Page No : 4

## Groups Printed- Cars

Start Time	Center St From North			Pleasant St From East			Police Station From South			Pleasant St From West			Int. Total
	Left	Thru	Right	Left	Thru	Right	Left	Thru	Right	Left	Thru	Right	
04:00 PM	15	0	66	1	174	12	0	0	2	70	155	0	495
04:15 PM	10	0	70	0	157	12	1	0	2	62	145	0	459
04:30 PM	13	0	69	0	163	18	1	1	0	58	143	0	466
04:45 PM	13	1	69	0	138	18	2	1	0	76	139	1	458
<b>Total</b>	<b>51</b>	<b>1</b>	<b>274</b>	<b>1</b>	<b>632</b>	<b>60</b>	<b>4</b>	<b>2</b>	<b>4</b>	<b>266</b>	<b>582</b>	<b>1</b>	<b>1878</b>
05:00 PM	19	0	80	0	143	9	0	0	1	75	153	0	480
05:15 PM	24	0	68	1	150	13	0	0	1	63	168	2	490
05:30 PM	14	1	73	0	140	9	1	2	0	70	154	1	465
05:45 PM	10	0	69	2	111	14	1	2	1	69	147	0	426
<b>Total</b>	<b>67</b>	<b>1</b>	<b>290</b>	<b>3</b>	<b>544</b>	<b>45</b>	<b>2</b>	<b>4</b>	<b>3</b>	<b>277</b>	<b>622</b>	<b>3</b>	<b>1861</b>
<b>Grand Total</b>	<b>118</b>	<b>2</b>	<b>564</b>	<b>4</b>	<b>1176</b>	<b>105</b>	<b>6</b>	<b>6</b>	<b>7</b>	<b>543</b>	<b>1204</b>	<b>4</b>	<b>3739</b>
Apprch %	17.3	0.3	82.5	0.3	91.5	8.2	31.6	31.6	36.8	31	68.8	0.2	
Total %	3.2	0.1	15.1	0.1	31.5	2.8	0.2	0.2	0.2	14.5	32.2	0.1	

Start Time	Center St From North				Pleasant St From East				Police Station From South				Pleasant St From West				Int. Total
	Left	Thru	Right	App. Total	Left	Thru	Right	App. Total	Left	Thru	Right	App. Total	Left	Thru	Right	App. Total	
Peak Hour Analysis From 04:00 PM to 05:45 PM - Peak 1 of 1																	
Peak Hour for Entire Intersection Begins at 04:30 PM																	
04:30 PM	13	0	69	82	0	<b>163</b>	<b>18</b>	<b>181</b>	1	<b>1</b>	0	2	58	143	0	201	466
04:45 PM	13	<b>1</b>	69	83	0	138	18	156	<b>2</b>	1	0	<b>3</b>	<b>76</b>	139	1	216	458
05:00 PM	19	0	<b>80</b>	<b>99</b>	0	143	9	152	0	0	<b>1</b>	1	75	153	0	228	480
05:15 PM	<b>24</b>	0	68	92	<b>1</b>	150	13	164	0	0	1	1	63	<b>168</b>	<b>2</b>	<b>233</b>	<b>490</b>
Total Volume	69	1	286	356	1	594	58	653	3	2	2	7	272	603	3	878	1894
% App. Total	19.4	0.3	80.3		0.2	91	8.9		42.9	28.6	28.6		31	68.7	0.3		
PHF	.719	.250	.894	.899	.250	.911	.806	.902	.375	.500	.500	.583	.895	.897	.375	.942	.966



# Accurate Counts

978-664-2565

N/S Street : Center St / Police Station  
 E/W Street : Pleasant Street  
 City/State : Bridgewater, MA  
 Weather : Clear

File Name : 202700B8  
 Site Code : 20270008  
 Start Date : 10/2/2024  
 Page No : 5

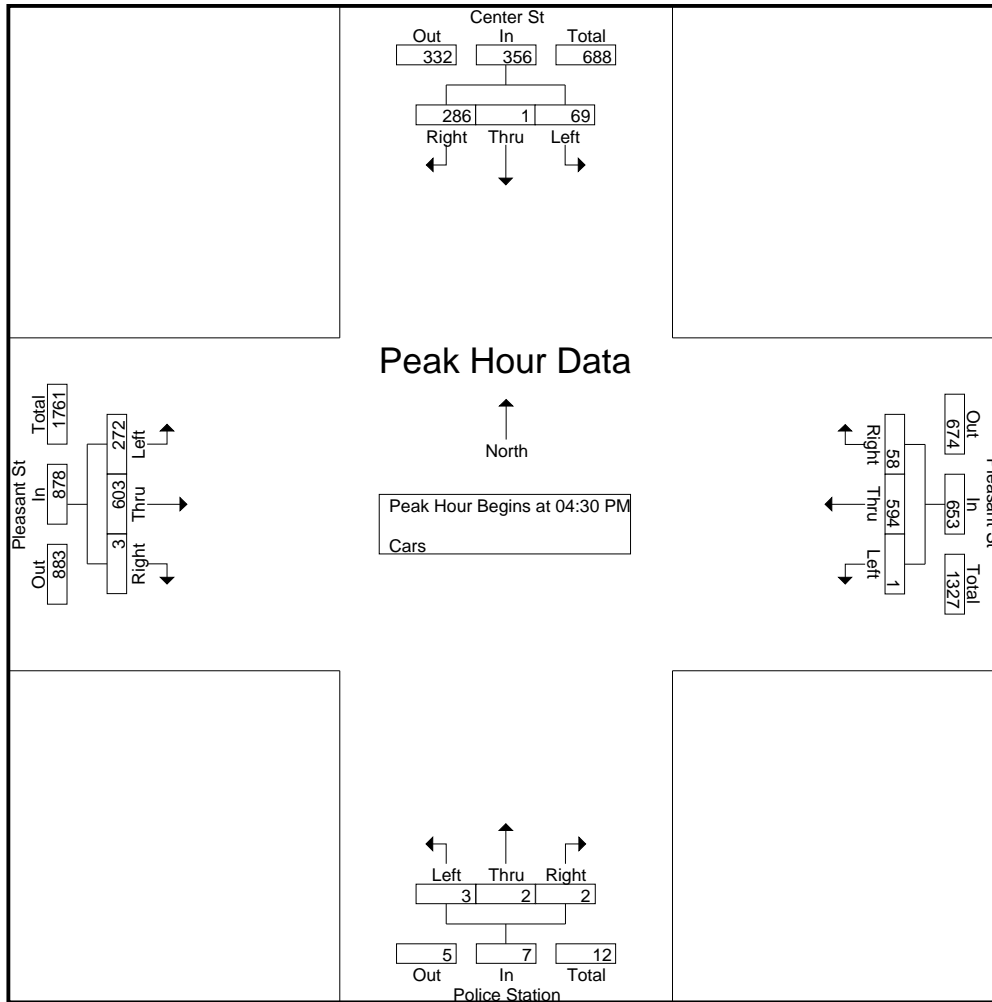

**Peak Hour Analysis From 04:00 PM to 05:45 PM - Peak 1 of 1**

**Peak Hour for Each Approach Begins at:**

	04:45 PM				04:00 PM				04:00 PM				04:45 PM			
+0 mins.	13	1	69	83	1	174	12	187	0	0	2	2	76	139	1	216
+15 mins.	19	0	80	99	0	157	12	169	1	0	2	3	75	153	0	228
+30 mins.	24	0	68	92	0	163	18	181	1	1	0	2	63	168	2	233
+45 mins.	14	1	73	88	0	138	18	156	2	1	0	3	70	154	1	225
<b>Total Volume</b>	70	2	290	362	1	632	60	693	4	2	4	10	284	614	4	902
<b>% App. Total</b>	19.3	0.6	80.1		0.1	91.2	8.7		40	20	40		31.5	68.1	0.4	
<b>PHF</b>	.729	.500	.906	.914	.250	.908	.833	.926	.500	.500	.500	.833	.934	.914	.500	.968

# Accurate Counts

978-664-2565

File Name : 202700B8

Site Code : 20270008

Start Date : 10/2/2024

Page No : 6

N/S Street : Center St / Police Station

E/W Street : Pleasant Street

City/State : Bridgewater, MA

Weather : Clear

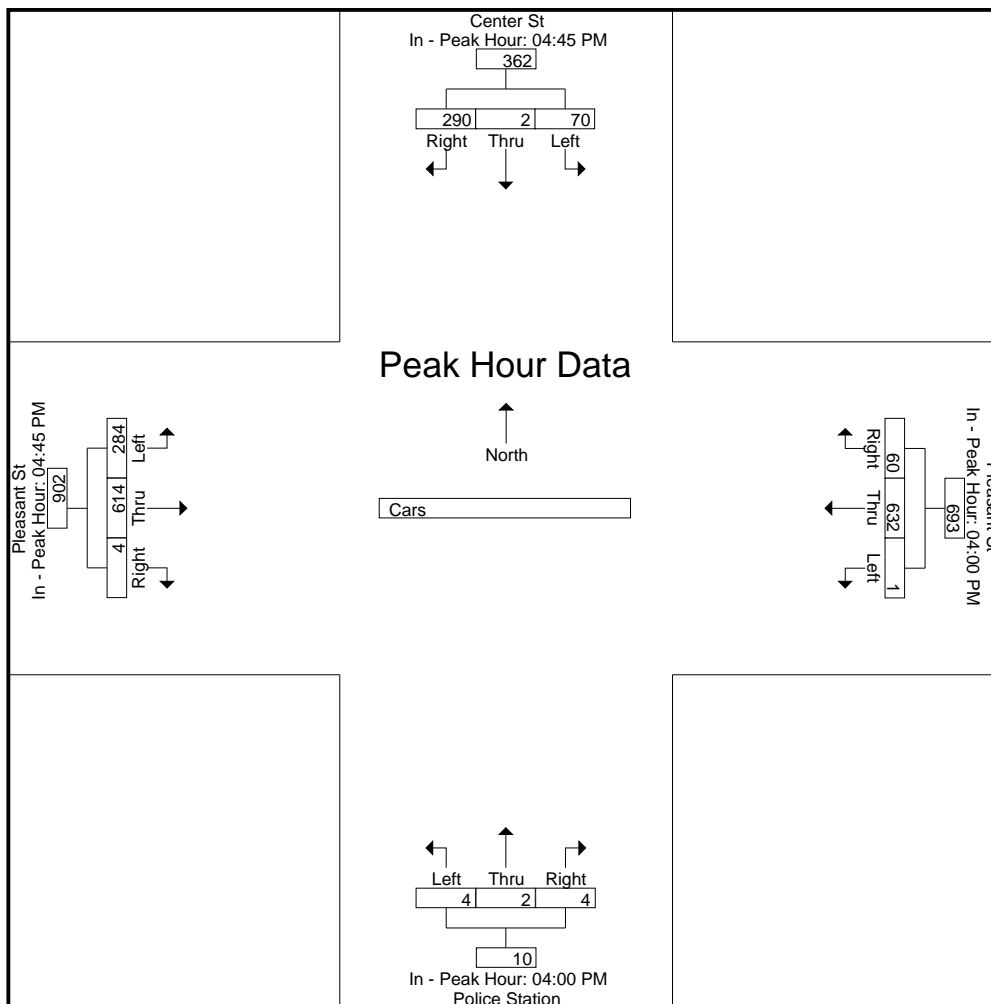

# Accurate Counts

978-664-2565

N/S Street : Center St / Police Station  
 E/W Street : Pleasant Street  
 City/State : Bridgewater, MA  
 Weather : Clear

File Name : 202700B8  
 Site Code : 20270008  
 Start Date : 10/2/2024  
 Page No : 7

### Groups Printed- Trucks

Start Time	Center St From North			Pleasant St From East			Police Station From South			Pleasant St From West			Int. Total
	Left	Thru	Right	Left	Thru	Right	Left	Thru	Right	Left	Thru	Right	
04:00 PM	0	0	0	0	3	0	0	0	0	1	5	0	9
04:15 PM	0	0	0	0	6	0	0	0	0	0	7	0	13
04:30 PM	0	0	0	0	1	0	0	0	0	0	6	0	7
04:45 PM	0	0	0	0	3	0	0	0	0	1	3	0	7
<b>Total</b>	0	0	0	0	13	0	0	0	0	2	21	0	36
05:00 PM	0	0	0	0	1	0	0	0	0	0	3	0	4
05:15 PM	0	0	0	0	1	0	0	0	0	0	1	0	2
05:30 PM	0	0	0	0	0	0	0	0	0	0	2	0	2
05:45 PM	0	0	0	0	0	0	0	0	0	2	2	0	4
<b>Total</b>	0	0	0	0	2	0	0	0	0	2	8	0	12
<b>Grand Total</b>	0	0	0	0	15	0	0	0	0	4	29	0	48
Apprch %	0	0	0	0	100	0	0	0	0	12.1	87.9	0	
Total %	0	0	0	0	31.2	0	0	0	0	8.3	60.4	0	

Start Time	Center St From North				Pleasant St From East				Police Station From South				Pleasant St From West				Int. Total
	Left	Thru	Right	App. Total	Left	Thru	Right	App. Total	Left	Thru	Right	App. Total	Left	Thru	Right	App. Total	
<b>Peak Hour Analysis From 04:00 PM to 05:45 PM - Peak 1 of 1</b>																	
<b>Peak Hour for Entire Intersection Begins at 04:00 PM</b>																	
04:00 PM	0	0	0	0	0	3	0	3	0	0	0	0	1	5	0	6	9
04:15 PM	0	0	0	0	0	6	0	6	0	0	0	0	0	7	0	7	13
04:30 PM	0	0	0	0	0	1	0	1	0	0	0	0	0	6	0	6	7
04:45 PM	0	0	0	0	0	3	0	3	0	0	0	0	1	3	0	4	7
<b>Total Volume</b>	0	0	0	0	0	13	0	13	0	0	0	0	2	21	0	23	36
<b>% App. Total</b>	0	0	0	0	0	100	0	100	0	0	0	0	8.7	91.3	0		
<b>PHF</b>	.000	.000	.000	.000	.000	.542	.000	.542	.000	.000	.000	.000	.500	.750	.000	.821	.692

# Accurate Counts

978-664-2565

N/S Street : Center St / Police Station  
 E/W Street : Pleasant Street  
 City/State : Bridgewater, MA  
 Weather : Clear

File Name : 202700B8  
 Site Code : 20270008  
 Start Date : 10/2/2024  
 Page No : 8

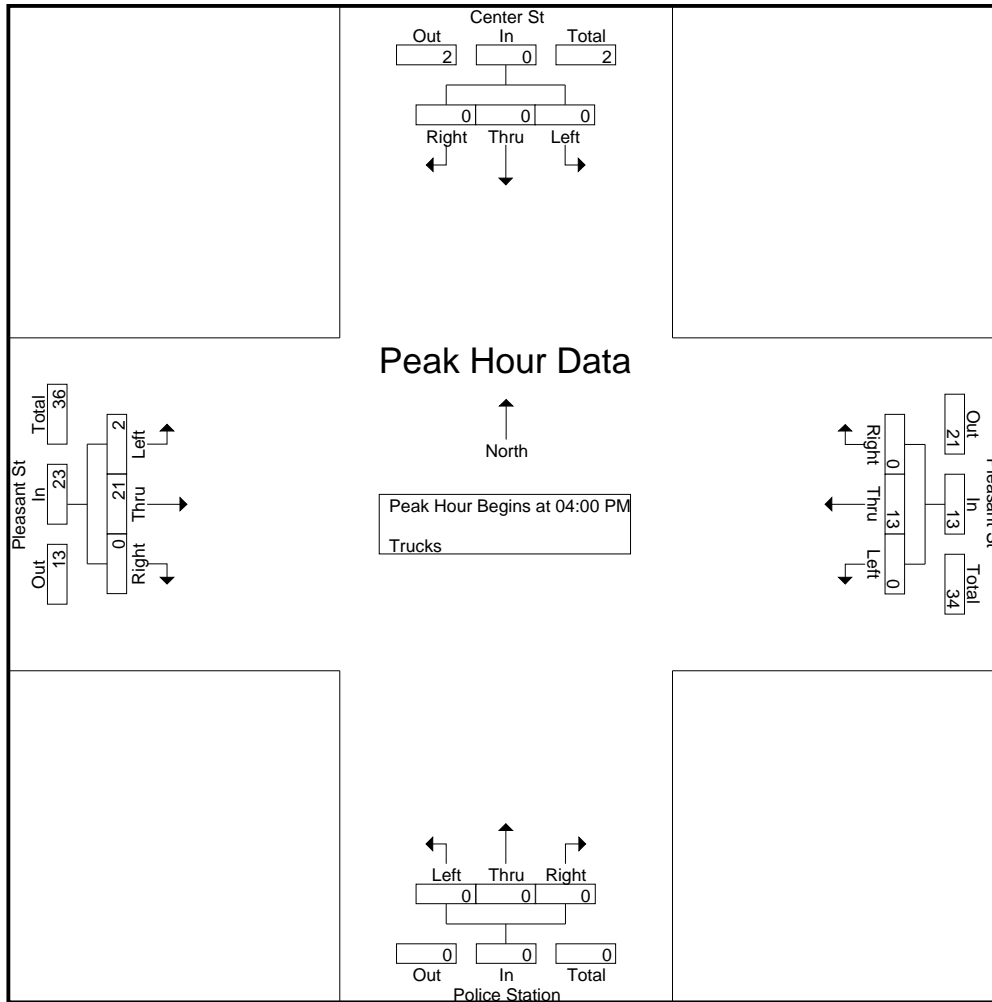

**Peak Hour Analysis From 04:00 PM to 05:45 PM - Peak 1 of 1**

**Peak Hour for Each Approach Begins at:**

	04:00 PM				04:00 PM				04:00 PM				04:00 PM			
+0 mins.	0	0	0	0	0	3	0	3	0	0	0	0	1	5	0	6
+15 mins.	0	0	0	0	0	6	0	6	0	0	0	0	0	7	0	7
+30 mins.	0	0	0	0	0	1	0	1	0	0	0	0	0	6	0	6
+45 mins.	0	0	0	0	0	3	0	3	0	0	0	0	1	3	0	4
Total Volume	0	0	0	0	0	13	0	13	0	0	0	0	2	21	0	23
% App. Total	0	0	0	0	0	100	0	0	0	0	0	0	8.7	91.3	0	0
PHF	.000	.000	.000	.000	.000	.542	.000	.542	.000	.000	.000	.000	.500	.750	.000	.821

# Accurate Counts

978-664-2565

N/S Street : Center St / Police Station  
E/W Street : Pleasant Street  
City/State : Bridgewater, MA  
Weather : Clear

File Name : 202700B8  
Site Code : 20270008  
Start Date : 10/2/2024  
Page No : 9

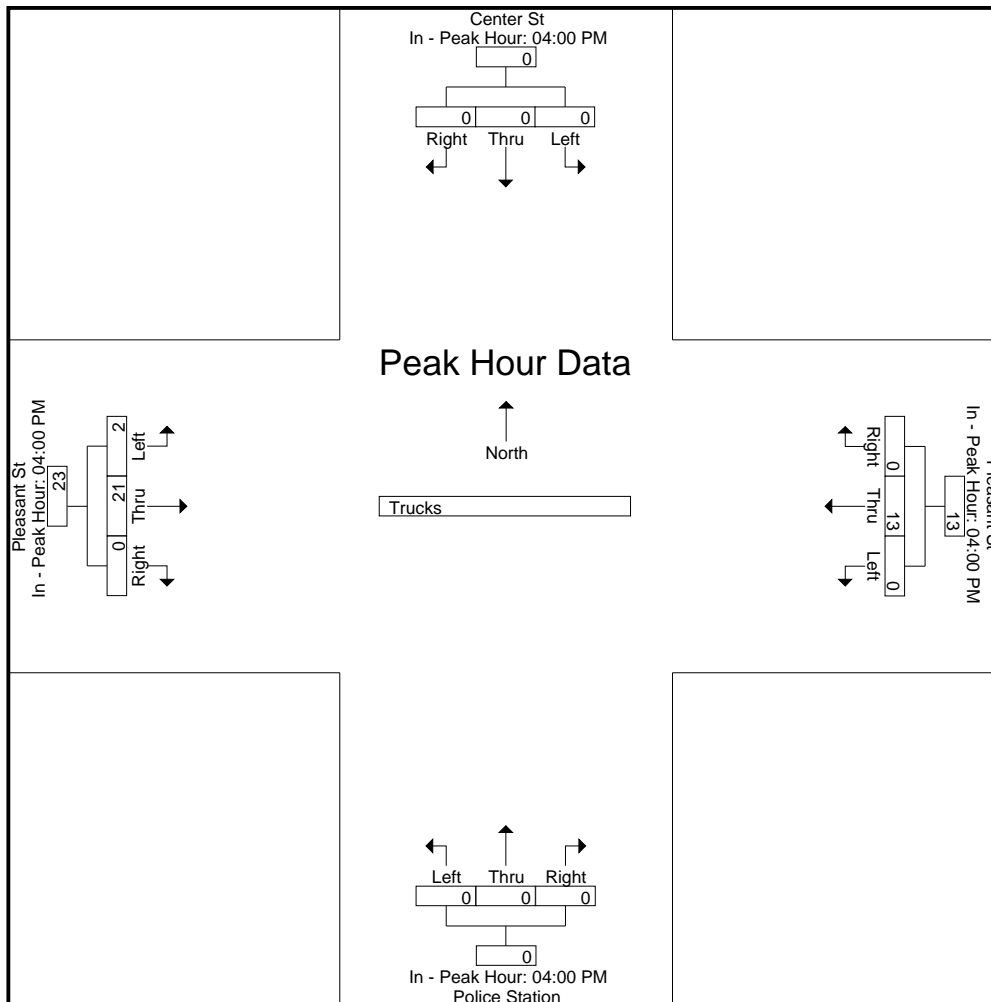

# Accurate Counts

978-664-2565

N/S Street : Center St / Police Station

E/W Street : Pleasant Street

City/State : Bridgewater, MA

Weather : Clear

File Name : 202700B8

Site Code : 20270008

Start Date : 10/2/2024

Page No : 10

## Groups Printed- Bikes Peds

Start Time	Center St From North				Pleasant St From East				Police Station From South				Pleasant St From West				Exclu. Total	Inclu. Total	Int. Total
	Left	Thru	Right	Peds	Left	Thru	Right	Peds	Left	Thru	Right	Peds	Left	Thru	Right	Peds			
04:00 PM	0	0	0	3	0	0	0	0	0	0	0	0	0	0	0	0	3	0	3
04:15 PM	0	0	0	0	0	0	0	0	0	0	0	0	0	0	0	0	0	0	0
04:30 PM	0	0	0	0	0	0	0	0	0	0	0	0	1	1	0	0	0	2	2
04:45 PM	0	0	0	3	0	0	0	0	0	0	0	0	0	0	0	2	5	0	5
<b>Total</b>	0	0	0	6	0	0	0	0	0	0	0	0	1	1	0	2	8	2	10
05:00 PM	0	0	1	1	0	0	0	0	0	0	0	0	0	0	0	0	1	1	2
05:15 PM	1	0	0	0	0	0	0	0	0	0	0	0	0	0	0	0	0	1	1
05:30 PM	0	0	0	1	0	0	0	0	0	0	0	0	0	0	0	0	1	0	1
05:45 PM	0	0	0	1	0	0	0	0	0	0	0	0	2	0	0	0	1	2	3
<b>Total</b>	1	0	1	3	0	0	0	0	0	0	0	0	2	0	0	0	3	4	7
<b>Grand Total</b>	1	0	1	9	0	0	0	0	0	0	0	0	3	1	0	2	11	6	17
Apprch %	50	0	50		0	0	0		0	0	0		75	25	0				
Total %	16.7	0	16.7		0	0	0		0	0	0		50	16.7	0		64.7	35.3	

Start Time	Center St From North				Pleasant St From East				Police Station From South				Pleasant St From West				Int. Total
	Left	Thru	Right	App. Total	Left	Thru	Right	App. Total	Left	Thru	Right	App. Total	Left	Thru	Right	App. Total	
Peak Hour Analysis From 04:00 PM to 05:45 PM - Peak 1 of 1																	
Peak Hour for Entire Intersection Begins at 04:30 PM																	
04:30 PM	0	0	0	0	0	0	0	0	0	0	0	0	1	1	0	2	2
04:45 PM	0	0	0	0	0	0	0	0	0	0	0	0	0	0	0	0	0
05:00 PM	0	0	1	1	0	0	0	0	0	0	0	0	0	0	0	0	1
05:15 PM	1	0	0	1	0	0	0	0	0	0	0	0	0	0	0	0	1
<b>Total Volume</b>	1	0	1	2	0	0	0	0	0	0	0	0	1	1	0	2	4
<b>% App. Total</b>	50	0	50		0	0	0		0	0	0		50	50	0		
PHF	.250	.000	.250	.500	.000	.000	.000	.000	.000	.000	.000	.000	.250	.250	.000	.250	.500

# Accurate Counts

978-664-2565

N/S Street : Center St / Police Station  
 E/W Street : Pleasant Street  
 City/State : Bridgewater, MA  
 Weather : Clear

File Name : 202700B8  
 Site Code : 20270008  
 Start Date : 10/2/2024  
 Page No : 11

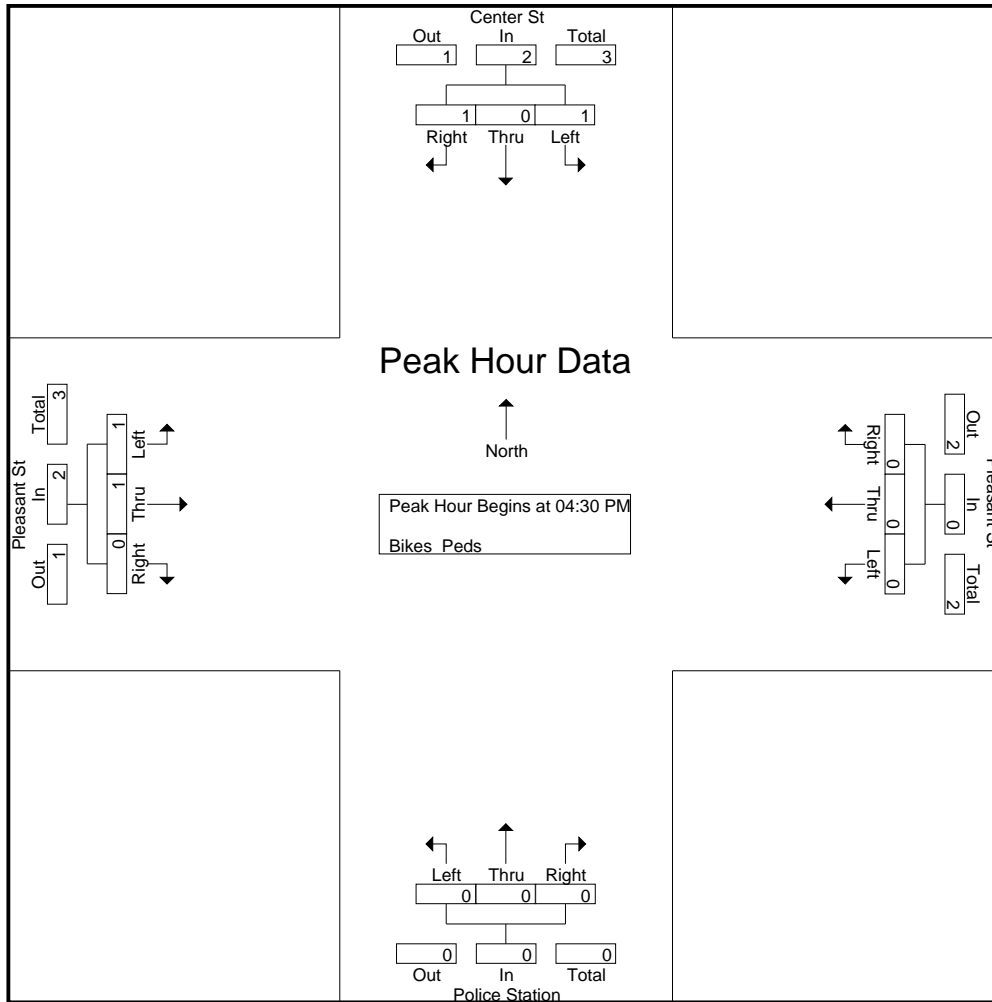

**Peak Hour Analysis From 04:00 PM to 05:45 PM - Peak 1 of 1**

Peak Hour for Each Approach Begins at:

	04:30 PM				04:00 PM				04:00 PM				04:00 PM			
+0 mins.	0	0	0	0	0	0	0	0	0	0	0	0	0	0	0	0
+15 mins.	0	0	0	0	0	0	0	0	0	0	0	0	0	0	0	0
+30 mins.	0	0	1	1	0	0	0	0	0	0	0	0	1	1	0	2
+45 mins.	1	0	0	1	0	0	0	0	0	0	0	0	0	0	0	0
Total Volume	1	0	1	2	0	0	0	0	0	0	0	0	1	1	0	2
% App. Total	50	0	50		0	0	0		0	0	0		50	50	0	
PHF	.250	.000	.250	.500	.000	.000	.000	.000	.000	.000	.000	.000	.250	.250	.000	.250

# Accurate Counts

978-664-2565

File Name : 202700B8

Site Code : 20270008

Start Date : 10/2/2024

Page No : 12

N/S Street : Center St / Police Station

E/W Street : Pleasant Street

City/State : Bridgewater, MA

Weather : Clear

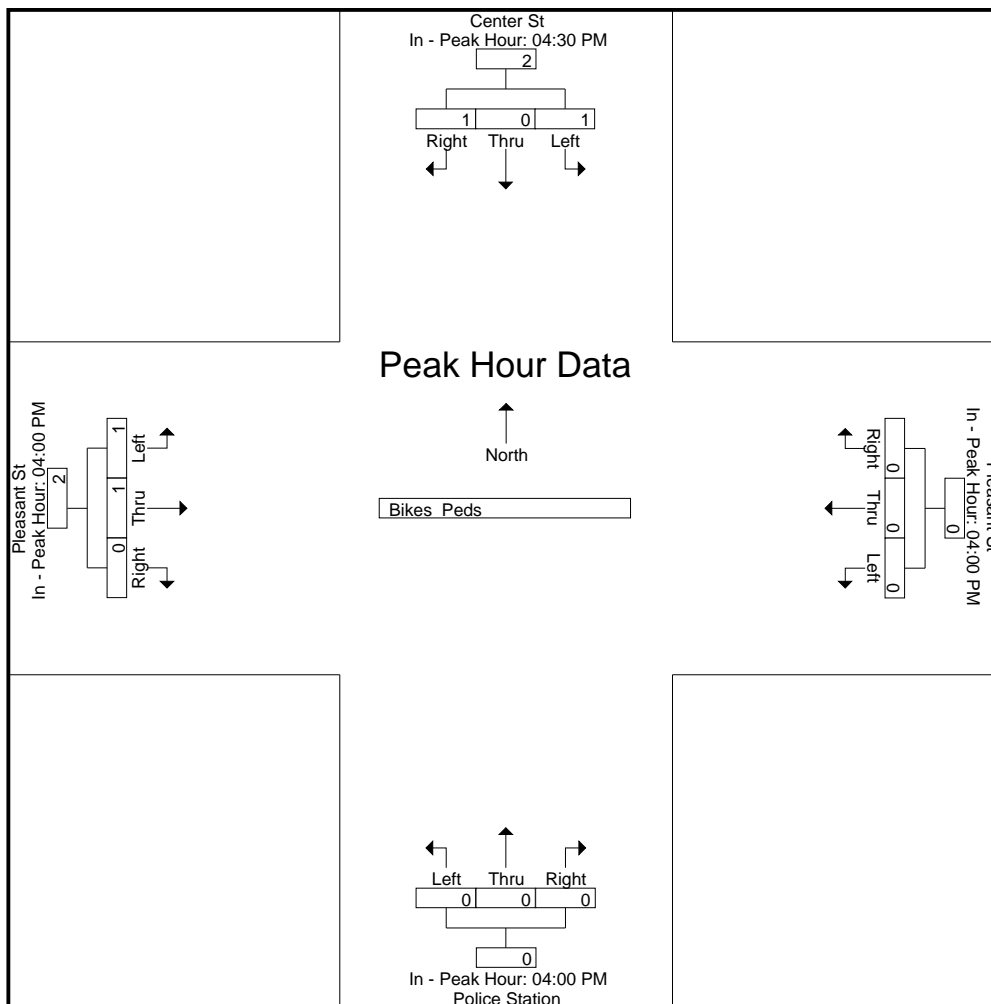



# Accurate Counts

978-664-2565

N/S Street : Winthrop Ave / Crescent St

E/W Street : Pleasant Street

City/State : Bridgewater, MA

Weather : Clear

File Name : 202700B9

Site Code : 20270009

Start Date : 10/2/2024

Page No : 1

## Groups Printed- Cars - Trucks

Start Time	Winthrop Ave From North			Pleasant St From East			Crescent St From South			Pleasant St From West			Int. Total
	Left	Thru	Right	Left	Thru	Right	Left	Thru	Right	Left	Thru	Right	
07:00 AM	0	0	0	2	121	0	64	0	0	0	96	18	301
07:15 AM	0	0	2	0	150	0	45	0	0	0	129	32	358
07:30 AM	0	2	0	2	112	0	31	0	0	0	141	26	314
07:45 AM	0	0	0	2	136	1	35	0	1	1	135	37	348
<b>Total</b>	<b>0</b>	<b>2</b>	<b>2</b>	<b>6</b>	<b>519</b>	<b>1</b>	<b>175</b>	<b>0</b>	<b>1</b>	<b>1</b>	<b>501</b>	<b>113</b>	<b>1321</b>
08:00 AM	1	3	1	4	147	1	38	1	1	0	114	32	343
08:15 AM	0	1	0	3	117	0	36	0	0	1	145	48	351
08:30 AM	0	0	0	3	91	0	28	0	1	0	138	51	312
08:45 AM	0	2	1	3	109	0	51	1	0	0	132	52	351
<b>Total</b>	<b>1</b>	<b>6</b>	<b>2</b>	<b>13</b>	<b>464</b>	<b>1</b>	<b>153</b>	<b>2</b>	<b>2</b>	<b>1</b>	<b>529</b>	<b>183</b>	<b>1357</b>
<b>Grand Total</b>	<b>1</b>	<b>8</b>	<b>4</b>	<b>19</b>	<b>983</b>	<b>2</b>	<b>328</b>	<b>2</b>	<b>3</b>	<b>2</b>	<b>1030</b>	<b>296</b>	<b>2678</b>
Apprch %	7.7	61.5	30.8	1.9	97.9	0.2	98.5	0.6	0.9	0.2	77.6	22.3	
Total %	0	0.3	0.1	0.7	36.7	0.1	12.2	0.1	0.1	0.1	38.5	11.1	
Cars	1	8	4	19	937	2	321	2	3	1	974	290	2562
% Cars	100	100	100	100	95.3	100	97.9	100	100	50	94.6	98	95.7
Trucks	0	0	0	0	46	0	7	0	0	1	56	6	116
% Trucks	0	0	0	0	4.7	0	2.1	0	0	50	5.4	2	4.3

Start Time	Winthrop Ave From North				Pleasant St From East				Crescent St From South				Pleasant St From West				Int. Total
	Left	Thru	Right	App. Total	Left	Thru	Right	App. Total	Left	Thru	Right	App. Total	Left	Thru	Right	App. Total	
Peak Hour Analysis From 07:00 AM to 08:45 AM - Peak 1 of 1																	
Peak Hour for Entire Intersection Begins at 07:15 AM																	
07:15 AM	0	0	<b>2</b>	2	0	<b>150</b>	0	150	<b>45</b>	0	0	<b>45</b>	0	129	32	161	<b>358</b>
07:30 AM	0	2	0	2	2	112	0	114	31	0	0	31	0	<b>141</b>	26	167	314
07:45 AM	0	0	0	0	2	136	<b>1</b>	139	35	0	<b>1</b>	36	<b>1</b>	135	<b>37</b>	<b>173</b>	348
08:00 AM	<b>1</b>	<b>3</b>	<b>1</b>	<b>5</b>	<b>4</b>	147	<b>1</b>	<b>152</b>	38	<b>1</b>	<b>1</b>	40	0	114	32	146	343
<b>Total Volume</b>	<b>1</b>	<b>5</b>	<b>3</b>	<b>9</b>	<b>8</b>	<b>545</b>	<b>2</b>	<b>555</b>	<b>149</b>	<b>1</b>	<b>2</b>	<b>152</b>	<b>1</b>	<b>519</b>	<b>127</b>	<b>647</b>	<b>1363</b>
% App. Total	11.1	55.6	33.3		1.4	98.2	0.4		98	0.7	1.3		0.2	80.2	19.6		
PHF	.250	.417	.375	.450	.500	.908	.500	.913	.828	.250	.500	.844	.250	.920	.858	.935	.952
Cars	1	5	3	9	8	523	2	533	145	1	2	148	1	495	124	620	1310
% Cars	100	100	100	100	100	96.0	100	96.0	97.3	100	100	97.4	100	95.4	97.6	95.8	96.1
Trucks	0	0	0	0	0	22	0	22	4	0	0	4	0	24	3	27	53
% Trucks	0	0	0	0	0	4.0	0	4.0	2.7	0	0	2.6	0	4.6	2.4	4.2	3.9

# Accurate Counts

978-664-2565

N/S Street : Winthrop Ave / Crescent St

E/W Street : Pleasant Street

City/State : Bridgewater, MA

Weather : Clear

File Name : 202700B9

Site Code : 20270009

Start Date : 10/2/2024

Page No : 2

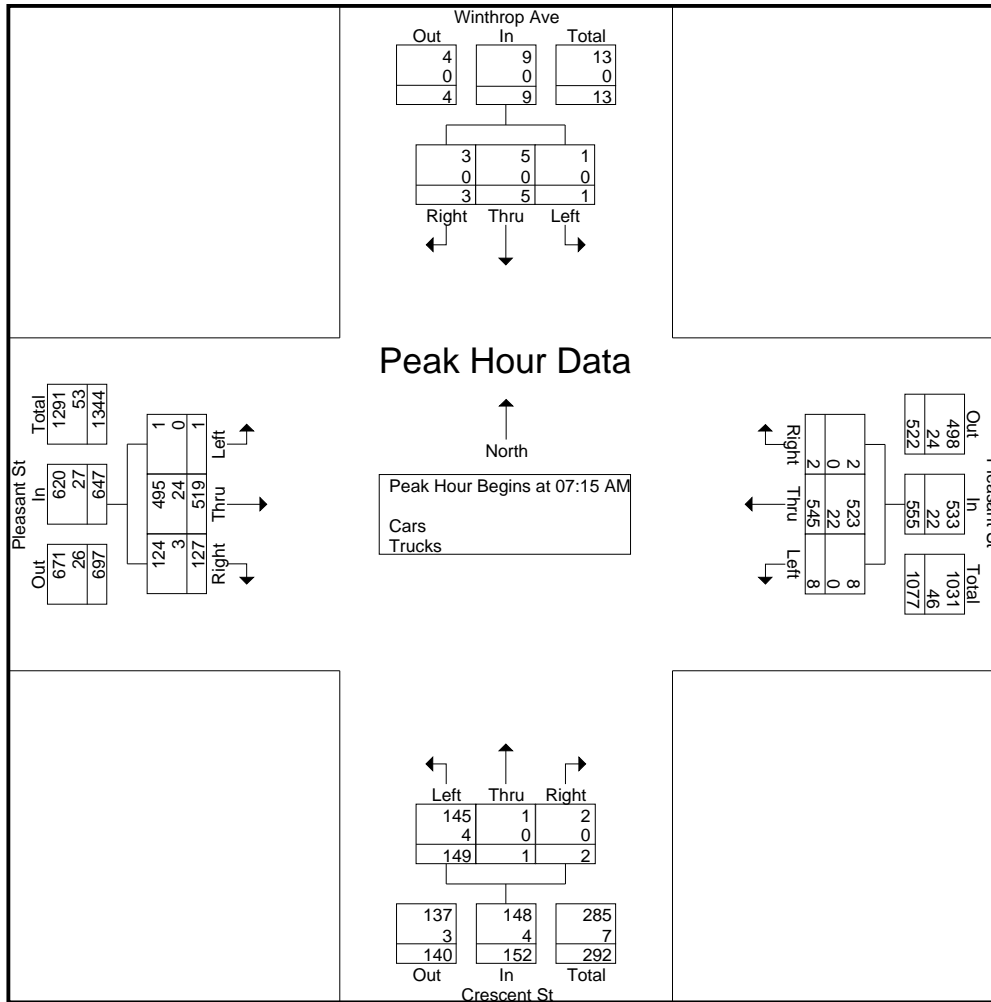

**Peak Hour Analysis From 07:00 AM to 08:45 AM - Peak 1 of 1**

**Peak Hour for Each Approach Begins at:**

	07:15 AM				07:15 AM				07:00 AM				08:00 AM			
+0 mins.	0	0	<b>2</b>	2	0	<b>150</b>	0	150	<b>64</b>	0	0	<b>64</b>	0	114	32	146
+15 mins.	0	2	0	2	2	112	0	114	45	0	0	45	<b>1</b>	<b>145</b>	48	<b>194</b>
+30 mins.	0	0	0	0	2	136	<b>1</b>	139	31	0	0	31	0	138	51	189
+45 mins.	<b>1</b>	<b>3</b>	1	<b>5</b>	<b>4</b>	147	1	<b>152</b>	35	0	<b>1</b>	36	0	132	<b>52</b>	184
Total Volume	1	5	3	9	8	545	2	555	175	0	1	176	1	529	183	713
% App. Total	11.1	55.6	33.3		1.4	98.2	0.4		99.4	0	0.6		0.1	74.2	25.7	
PHF	.250	.417	.375	.450	.500	.908	.500	.913	.684	.000	.250	.688	.250	.912	.880	.919
Cars	1	5	3	9	8	523	2	533	172	0	1	173	0	499	180	679
% Cars	100	100	100	100	100	96	100	96	98.3	0	100	98.3	0	94.3	98.4	95.2
Trucks	0	0	0	0	0	22	0	22	3	0	0	3	1	30	3	34
% Trucks	0	0	0	0	0	4	0	4	1.7	0	0	1.7	100	5.7	1.6	4.8

# Accurate Counts

978-664-2565

File Name : 202700B9

Site Code : 20270009

Start Date : 10/2/2024

Page No : 3

N/S Street : Winthrop Ave / Crescent St

E/W Street : Pleasant Street

City/State : Bridgewater, MA

Weather : Clear

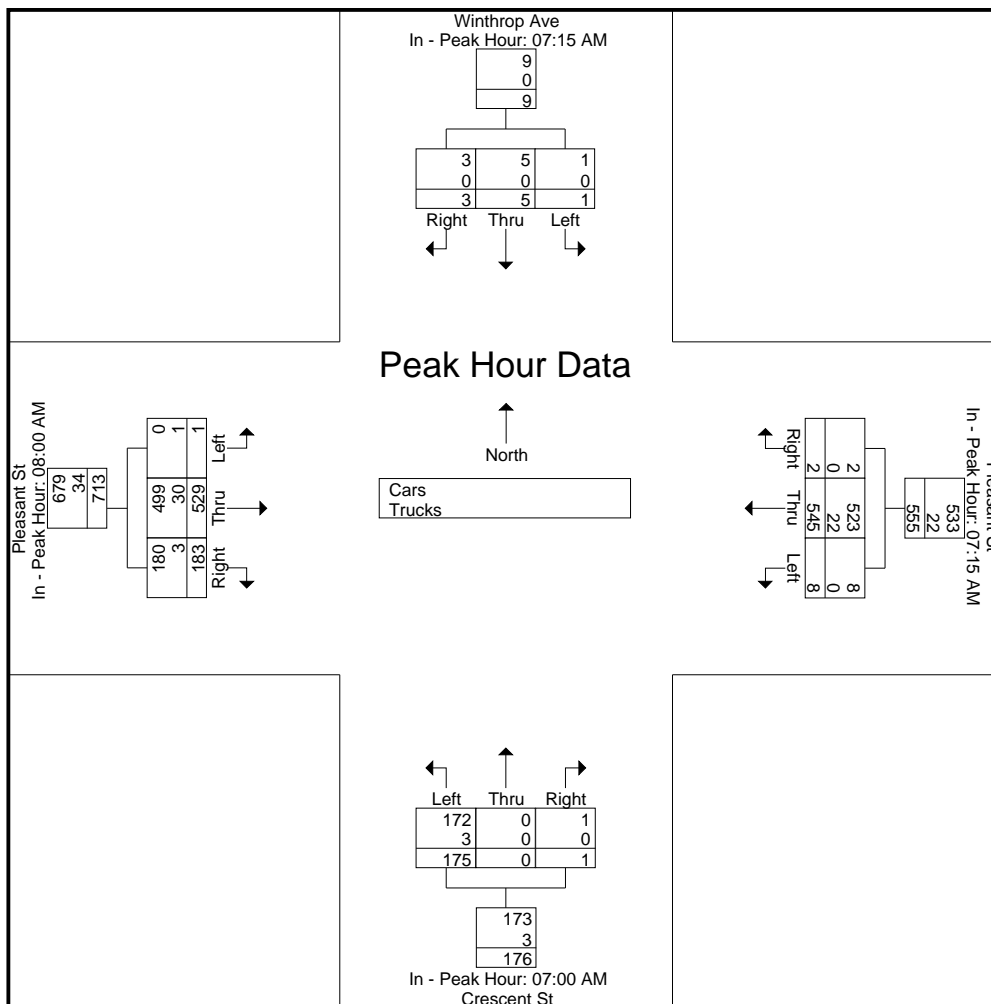

# Accurate Counts

978-664-2565

N/S Street : Winthrop Ave / Crescent St  
 E/W Street : Pleasant Street  
 City/State : Bridgewater, MA  
 Weather : Clear

File Name : 202700B9  
 Site Code : 20270009  
 Start Date : 10/2/2024  
 Page No : 4

## Groups Printed- Cars

Start Time	Winthrop Ave From North			Pleasant St From East			Crescent St From South			Pleasant St From West			Int. Total
	Left	Thru	Right	Left	Thru	Right	Left	Thru	Right	Left	Thru	Right	
07:00 AM	0	0	0	2	113	0	62	0	0	0	88	18	283
07:15 AM	0	0	2	0	148	0	44	0	0	0	121	32	347
07:30 AM	0	2	0	2	108	0	31	0	0	0	134	25	302
07:45 AM	0	0	0	2	128	1	35	0	1	1	132	35	335
<b>Total</b>	<b>0</b>	<b>2</b>	<b>2</b>	<b>6</b>	<b>497</b>	<b>1</b>	<b>172</b>	<b>0</b>	<b>1</b>	<b>1</b>	<b>475</b>	<b>110</b>	<b>1267</b>
08:00 AM	1	3	1	4	139	1	35	1	1	0	108	32	326
08:15 AM	0	1	0	3	108	0	35	0	0	0	137	47	331
08:30 AM	0	0	0	3	85	0	28	0	1	0	128	51	296
08:45 AM	0	2	1	3	108	0	51	1	0	0	126	50	342
<b>Total</b>	<b>1</b>	<b>6</b>	<b>2</b>	<b>13</b>	<b>440</b>	<b>1</b>	<b>149</b>	<b>2</b>	<b>2</b>	<b>0</b>	<b>499</b>	<b>180</b>	<b>1295</b>
<b>Grand Total</b>	<b>1</b>	<b>8</b>	<b>4</b>	<b>19</b>	<b>937</b>	<b>2</b>	<b>321</b>	<b>2</b>	<b>3</b>	<b>1</b>	<b>974</b>	<b>290</b>	<b>2562</b>
Apprch %	7.7	61.5	30.8	2	97.8	0.2	98.5	0.6	0.9	0.1	77	22.9	
Total %	0	0.3	0.2	0.7	36.6	0.1	12.5	0.1	0.1	0	38	11.3	

Start Time	Winthrop Ave From North				Pleasant St From East				Crescent St From South				Pleasant St From West				Int. Total
	Left	Thru	Right	App. Total	Left	Thru	Right	App. Total	Left	Thru	Right	App. Total	Left	Thru	Right	App. Total	
<b>Peak Hour Analysis From 07:00 AM to 08:45 AM - Peak 1 of 1</b>																	
<b>Peak Hour for Entire Intersection Begins at 07:15 AM</b>																	
07:15 AM	0	0	2	2	0	<b>148</b>	0	<b>148</b>	<b>44</b>	0	0	<b>44</b>	0	121	32	153	<b>347</b>
07:30 AM	0	2	0	2	2	108	0	110	31	0	0	31	0	<b>134</b>	25	159	302
07:45 AM	0	0	0	0	2	128	1	131	35	0	1	36	1	132	<b>35</b>	<b>168</b>	335
08:00 AM	1	3	1	5	4	139	1	144	35	1	1	37	0	108	32	140	326
<b>Total Volume</b>	1	5	3	9	8	523	2	533	145	1	2	148	1	495	124	620	1310
% App. Total	11.1	55.6	33.3		1.5	98.1	0.4		98	0.7	1.4		0.2	79.8	20		
PHF	.250	.417	.375	.450	.500	.883	.500	.900	.824	.250	.500	.841	.250	.924	.886	.923	.944

# Accurate Counts

978-664-2565

N/S Street : Winthrop Ave / Crescent St

E/W Street : Pleasant Street

City/State : Bridgewater, MA

Weather : Clear

File Name : 202700B9

Site Code : 20270009

Start Date : 10/2/2024

Page No : 5

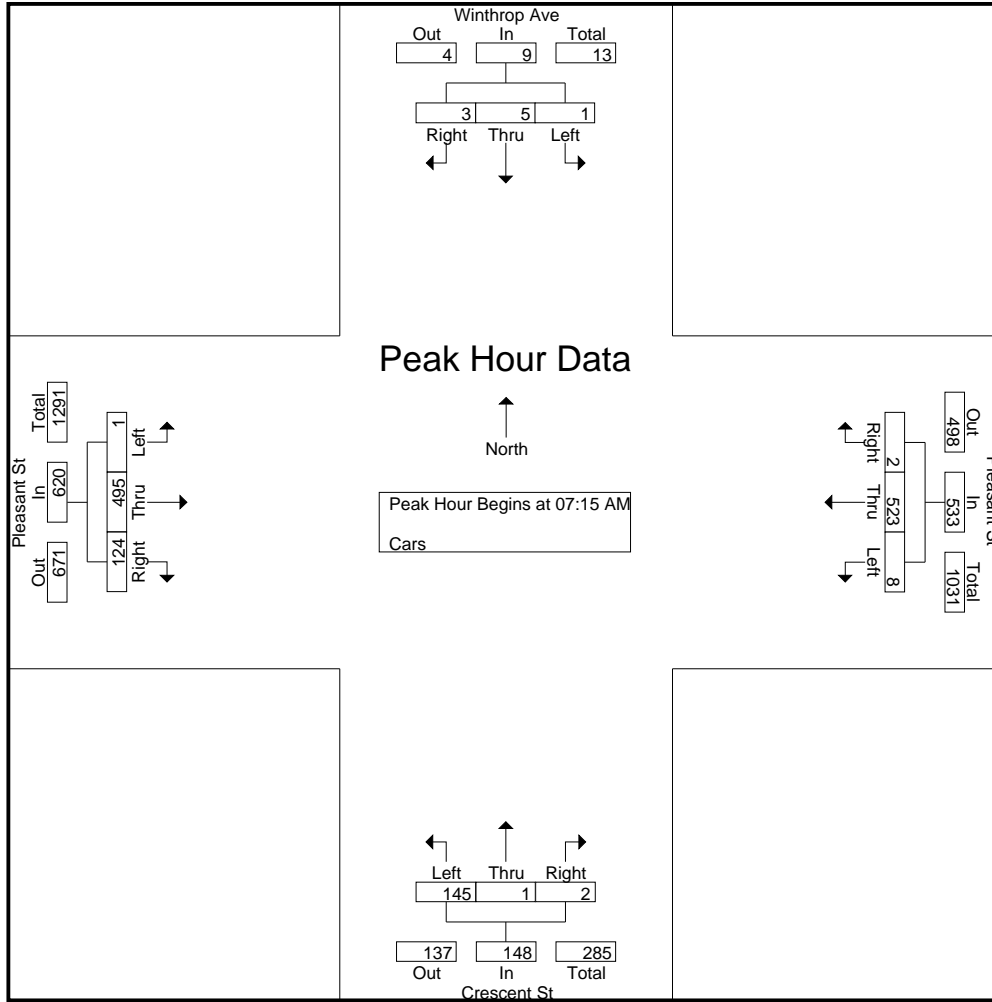

**Peak Hour Analysis From 07:00 AM to 08:45 AM - Peak 1 of 1**

**Peak Hour for Each Approach Begins at:**

	07:15 AM				07:15 AM				07:00 AM				08:00 AM			
+0 mins.	0	0	2	2	0	148	0	148	62	0	0	62	0	108	32	140
+15 mins.	0	2	0	2	2	108	0	110	44	0	0	44	0	137	47	184
+30 mins.	0	0	0	0	2	128	1	131	31	0	0	31	0	128	51	179
+45 mins.	1	3	1	5	4	139	1	144	35	0	1	36	0	126	50	176
Total Volume	1	5	3	9	8	523	2	533	172	0	1	173	0	499	180	679
% App. Total	11.1	55.6	33.3		1.5	98.1	0.4		99.4	0	0.6		0	73.5	26.5	
PHF	.250	.417	.375	.450	.500	.883	.500	.900	.694	.000	.250	.698	.000	.911	.882	.923

# Accurate Counts

978-664-2565

File Name : 202700B9

Site Code : 20270009

Start Date : 10/2/2024

Page No : 6

N/S Street : Winthrop Ave / Crescent St

E/W Street : Pleasant Street

City/State : Bridgewater, MA

Weather : Clear

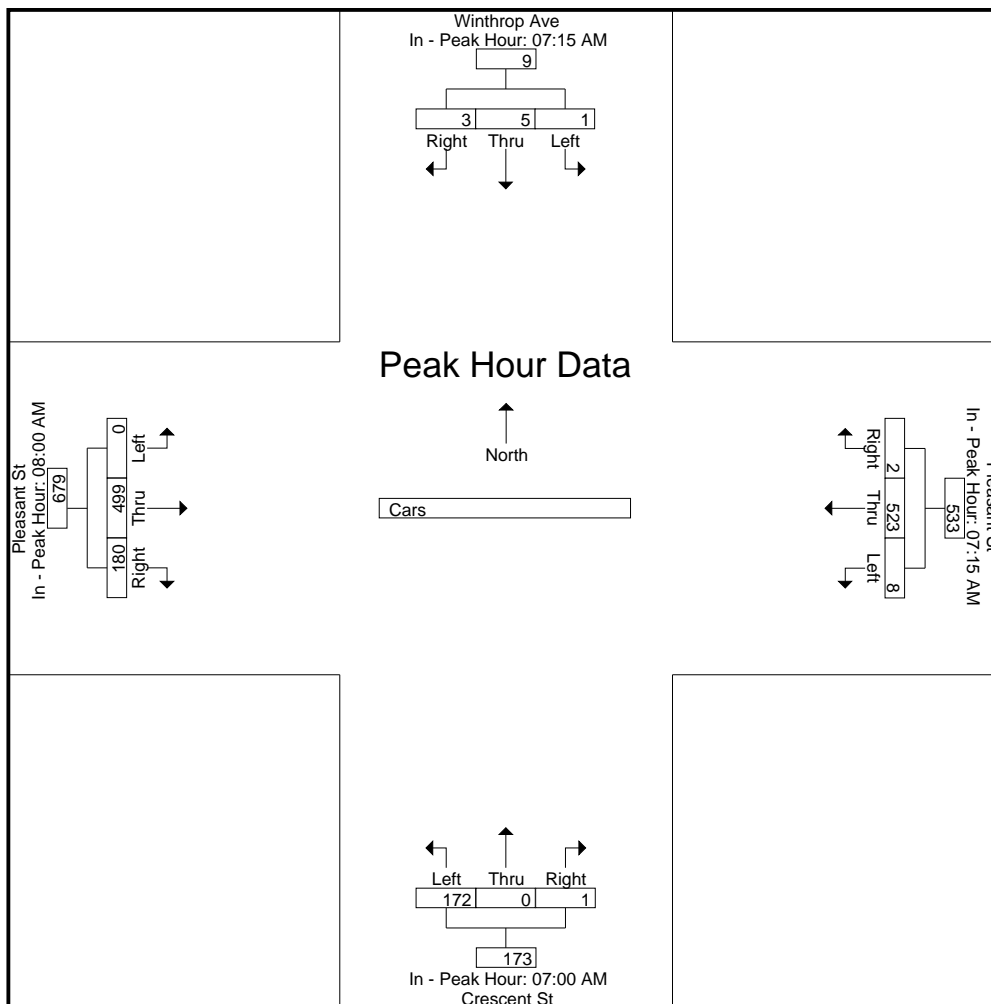

# Accurate Counts

978-664-2565

N/S Street : Winthrop Ave / Crescent St

E/W Street : Pleasant Street

City/State : Bridgewater, MA

Weather : Clear

File Name : 202700B9

Site Code : 20270009

Start Date : 10/2/2024

Page No : 7

## Groups Printed- Trucks

Start Time	Winthrop Ave From North			Pleasant St From East			Crescent St From South			Pleasant St From West			Int. Total
	Left	Thru	Right	Left	Thru	Right	Left	Thru	Right	Left	Thru	Right	
07:00 AM	0	0	0	0	8	0	2	0	0	0	8	0	18
07:15 AM	0	0	0	0	2	0	1	0	0	0	8	0	11
07:30 AM	0	0	0	0	4	0	0	0	0	0	7	1	12
07:45 AM	0	0	0	0	8	0	0	0	0	0	3	2	13
<b>Total</b>	0	0	0	0	22	0	3	0	0	0	26	3	54
08:00 AM	0	0	0	0	8	0	3	0	0	0	6	0	17
08:15 AM	0	0	0	0	9	0	1	0	0	1	8	1	20
08:30 AM	0	0	0	0	6	0	0	0	0	0	10	0	16
08:45 AM	0	0	0	0	1	0	0	0	0	0	6	2	9
<b>Total</b>	0	0	0	0	24	0	4	0	0	1	30	3	62
<b>Grand Total</b>	0	0	0	0	46	0	7	0	0	1	56	6	116
Apprch %	0	0	0	0	100	0	100	0	0	1.6	88.9	9.5	
Total %	0	0	0	0	39.7	0	6	0	0	0.9	48.3	5.2	

Start Time	Winthrop Ave From North				Pleasant St From East				Crescent St From South				Pleasant St From West				Int. Total
	Left	Thru	Right	App. Total	Left	Thru	Right	App. Total	Left	Thru	Right	App. Total	Left	Thru	Right	App. Total	
<b>Peak Hour Analysis From 07:00 AM to 08:45 AM - Peak 1 of 1</b>																	
<b>Peak Hour for Entire Intersection Begins at 07:45 AM</b>																	
07:45 AM	0	0	0	0	0	8	0	8	0	0	0	0	0	3	2	5	13
08:00 AM	0	0	0	0	0	8	0	8	3	0	0	3	0	6	0	6	17
08:15 AM	0	0	0	0	0	9	0	9	1	0	0	1	1	8	1	10	20
08:30 AM	0	0	0	0	0	6	0	6	0	0	0	0	0	10	0	10	16
<b>Total Volume</b>	0	0	0	0	0	31	0	31	4	0	0	4	1	27	3	31	66
<b>% App. Total</b>	0	0	0	0	0	100	0	100	100	0	0	100	3.2	87.1	9.7		
<b>PHF</b>	.000	.000	.000	.000	.000	.861	.000	.861	.333	.000	.000	.333	.250	.675	.375	.775	.825

# Accurate Counts

978-664-2565

N/S Street : Winthrop Ave / Crescent St  
 E/W Street : Pleasant Street  
 City/State : Bridgewater, MA  
 Weather : Clear

File Name : 202700B9  
 Site Code : 20270009  
 Start Date : 10/2/2024  
 Page No : 8

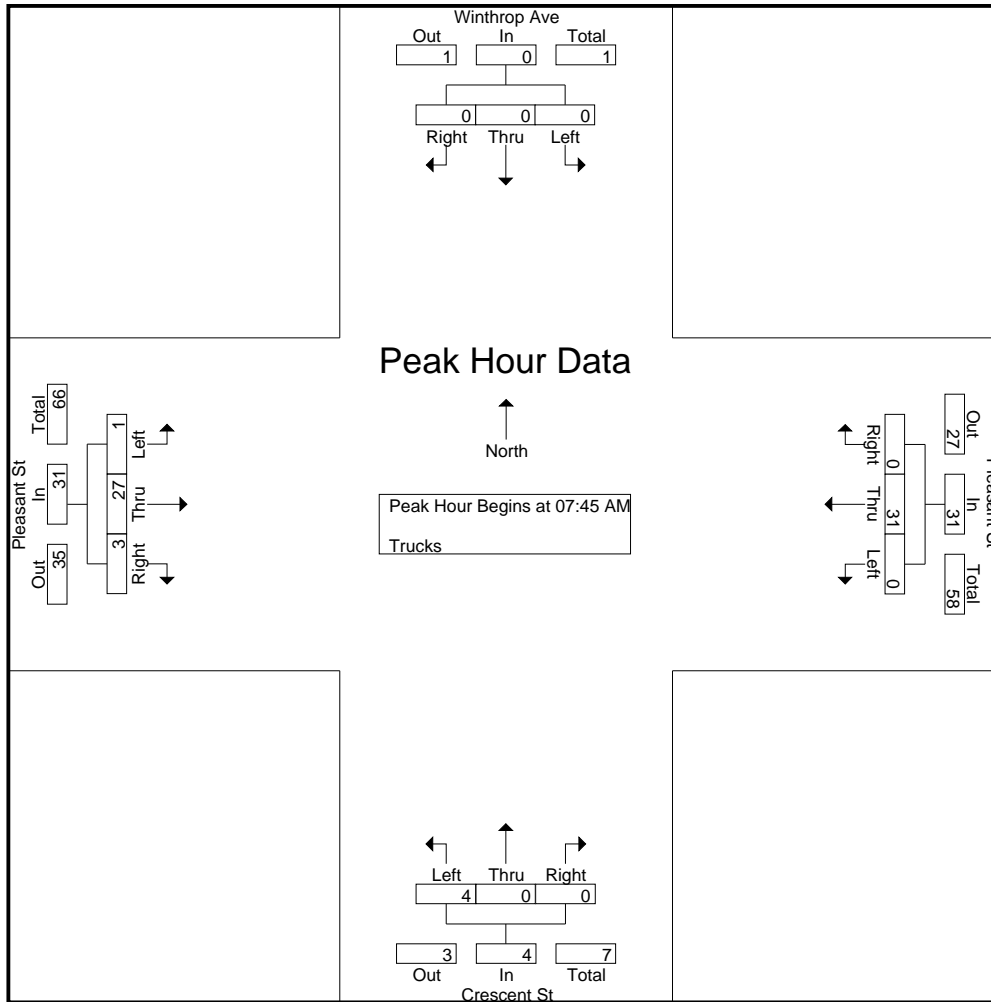

**Peak Hour Analysis From 07:00 AM to 08:45 AM - Peak 1 of 1**

**Peak Hour for Each Approach Begins at:**

	07:00 AM				07:45 AM				07:15 AM				08:00 AM			
+0 mins.	0	0	0	0	0	8	0	8	1	0	0	1	0	6	0	6
+15 mins.	0	0	0	0	0	8	0	8	0	0	0	0	1	8	1	10
+30 mins.	0	0	0	0	0	9	0	9	0	0	0	0	0	10	0	10
+45 mins.	0	0	0	0	0	6	0	6	3	0	0	3	0	6	2	8
Total Volume	0	0	0	0	0	31	0	31	4	0	0	4	1	30	3	34
% App. Total	0	0	0	0	0	100	0	100	100	0	0	100	2.9	88.2	8.8	100
PHF	.000	.000	.000	.000	.000	.861	.000	.861	.333	.000	.000	.333	.250	.750	.375	.850



# Accurate Counts

978-664-2565

File Name : 202700B9

Site Code : 20270009

Start Date : 10/2/2024

Page No : 9

N/S Street : Winthrop Ave / Crescent St

E/W Street : Pleasant Street

City/State : Bridgewater, MA

Weather : Clear

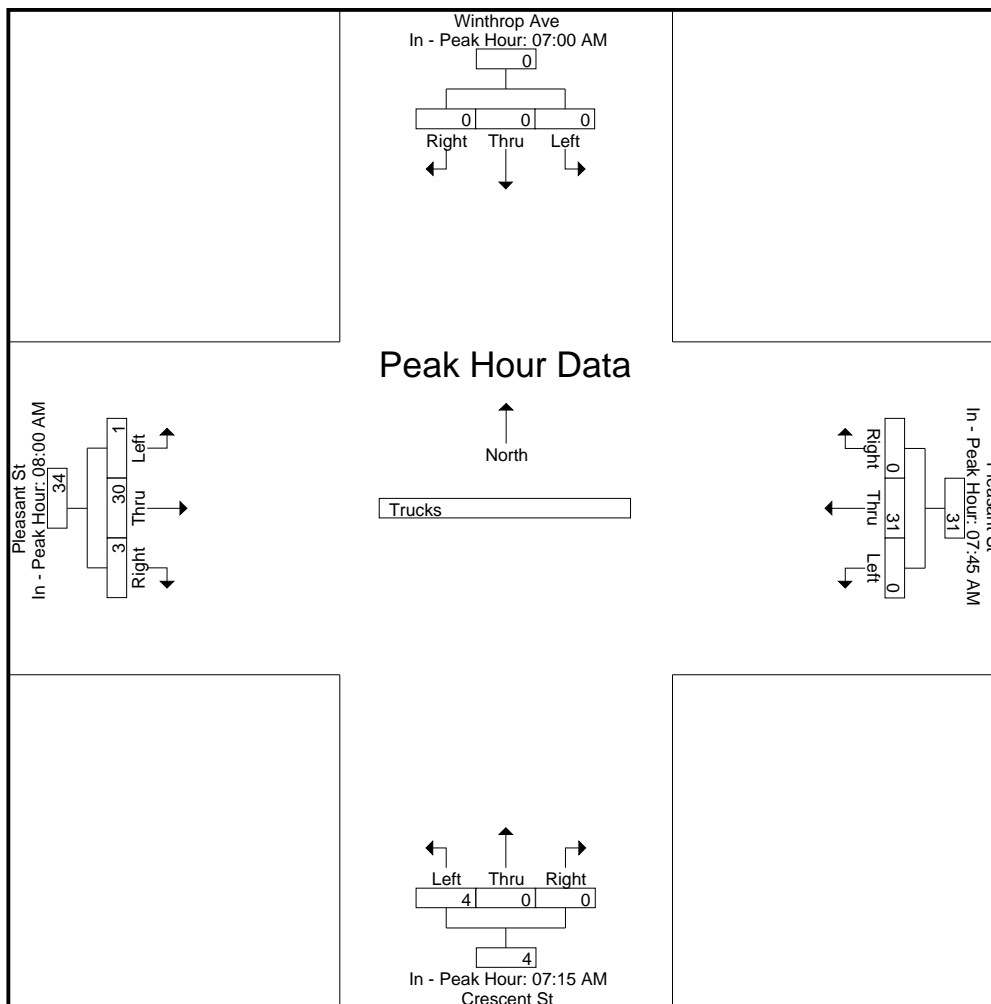

# Accurate Counts

978-664-2565

N/S Street : Winthrop Ave / Crescent St

E/W Street : Pleasant Street

City/State : Bridgewater, MA

Weather : Clear

File Name : 202700B9

Site Code : 20270009

Start Date : 10/2/2024

Page No : 10

## Groups Printed- Bikes Peds

Start Time	Winthrop Ave From North				Pleasant St From East				Crescent St From South				Pleasant St From West				Exclu. Total	Inclu. Total	Int. Total
	Left	Thru	Right	Peds	Left	Thru	Right	Peds	Left	Thru	Right	Peds	Left	Thru	Right	Peds			
07:00 AM	0	0	0	1	0	0	0	0	0	0	0	0	0	0	0	0	1	0	1
07:15 AM	0	0	0	1	0	0	0	0	0	0	0	0	0	0	0	0	1	0	1
07:30 AM	0	0	0	0	0	0	0	0	0	0	0	0	0	0	0	0	0	0	0
07:45 AM	0	0	0	1	0	0	0	0	0	0	0	0	0	0	0	0	1	0	1
<b>Total</b>	0	0	0	3	0	0	0	0	0	0	0	0	0	0	0	0	3	0	3
08:00 AM	0	0	0	0	0	0	0	0	0	0	0	0	0	0	0	0	0	0	0
08:15 AM	0	0	0	0	0	0	0	0	0	0	0	0	0	0	0	0	0	0	0
08:30 AM	0	0	0	1	0	0	0	0	0	0	0	0	0	0	0	0	1	0	1
08:45 AM	0	0	0	1	0	0	0	0	0	0	0	0	0	0	0	0	1	0	1
<b>Total</b>	0	0	0	2	0	0	0	0	0	0	0	0	0	0	0	0	2	0	2
<b>Grand Total</b>	0	0	0	5	0	0	0	0	0	0	0	0	0	0	0	0	5	0	5
Apprch %	0	0	0		0	0	0		0	0	0		0	0	0				
Total %																	100	0	

Start Time	Winthrop Ave From North				Pleasant St From East				Crescent St From South				Pleasant St From West				Int. Total
	Left	Thru	Right	App. Total	Left	Thru	Right	App. Total	Left	Thru	Right	App. Total	Left	Thru	Right	App. Total	
Peak Hour Analysis From 07:00 AM to 08:45 AM - Peak 1 of 1																	
Peak Hour for Entire Intersection Begins at 07:00 AM																	
07:00 AM	0	0	0	0	0	0	0	0	0	0	0	0	0	0	0	0	0
07:15 AM	0	0	0	0	0	0	0	0	0	0	0	0	0	0	0	0	0
07:30 AM	0	0	0	0	0	0	0	0	0	0	0	0	0	0	0	0	0
07:45 AM	0	0	0	0	0	0	0	0	0	0	0	0	0	0	0	0	0
<b>Total Volume</b>	0	0	0	0	0	0	0	0	0	0	0	0	0	0	0	0	0
<b>% App. Total</b>	0	0	0		0	0	0		0	0	0		0	0	0		
PHF	.000	.000	.000	.000	.000	.000	.000	.000	.000	.000	.000	.000	.000	.000	.000	.000	.000

# Accurate Counts

978-664-2565

N/S Street : Winthrop Ave / Crescent St

E/W Street : Pleasant Street

City/State : Bridgewater, MA

Weather : Clear

File Name : 202700B9

Site Code : 20270009

Start Date : 10/2/2024

Page No : 11

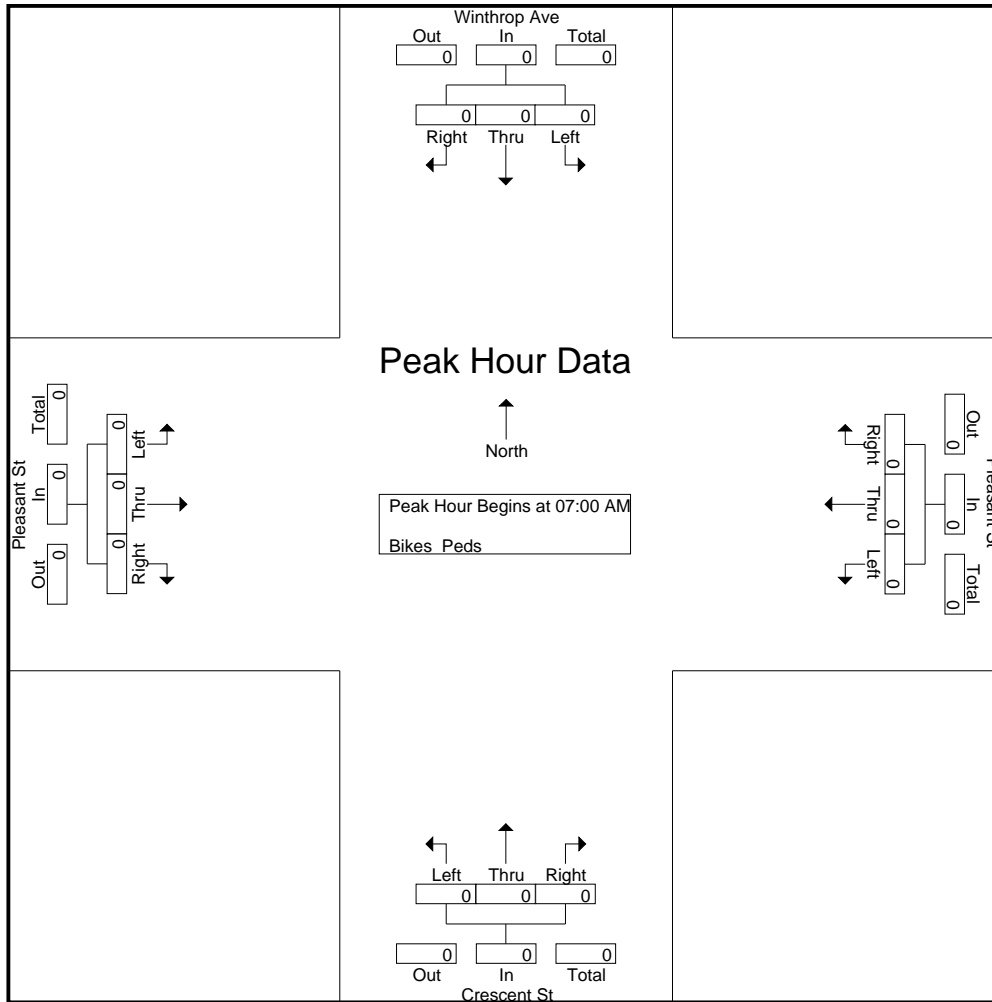

**Peak Hour Analysis From 07:00 AM to 08:45 AM - Peak 1 of 1**

**Peak Hour for Each Approach Begins at:**

	07:00 AM				07:00 AM				07:00 AM				07:00 AM			
+0 mins.	0	0	0	0	0	0	0	0	0	0	0	0	0	0	0	0
+15 mins.	0	0	0	0	0	0	0	0	0	0	0	0	0	0	0	0
+30 mins.	0	0	0	0	0	0	0	0	0	0	0	0	0	0	0	0
+45 mins.	0	0	0	0	0	0	0	0	0	0	0	0	0	0	0	0
Total Volume	0	0	0	0	0	0	0	0	0	0	0	0	0	0	0	0
% App. Total	0	0	0	0	0	0	0	0	0	0	0	0	0	0	0	0
PHF	.000	.000	.000	.000	.000	.000	.000	.000	.000	.000	.000	.000	.000	.000	.000	.000

# Accurate Counts

978-664-2565

File Name : 202700B9

Site Code : 20270009

Start Date : 10/2/2024

Page No : 12

N/S Street : Winthrop Ave / Crescent St

E/W Street : Pleasant Street

City/State : Bridgewater, MA

Weather : Clear

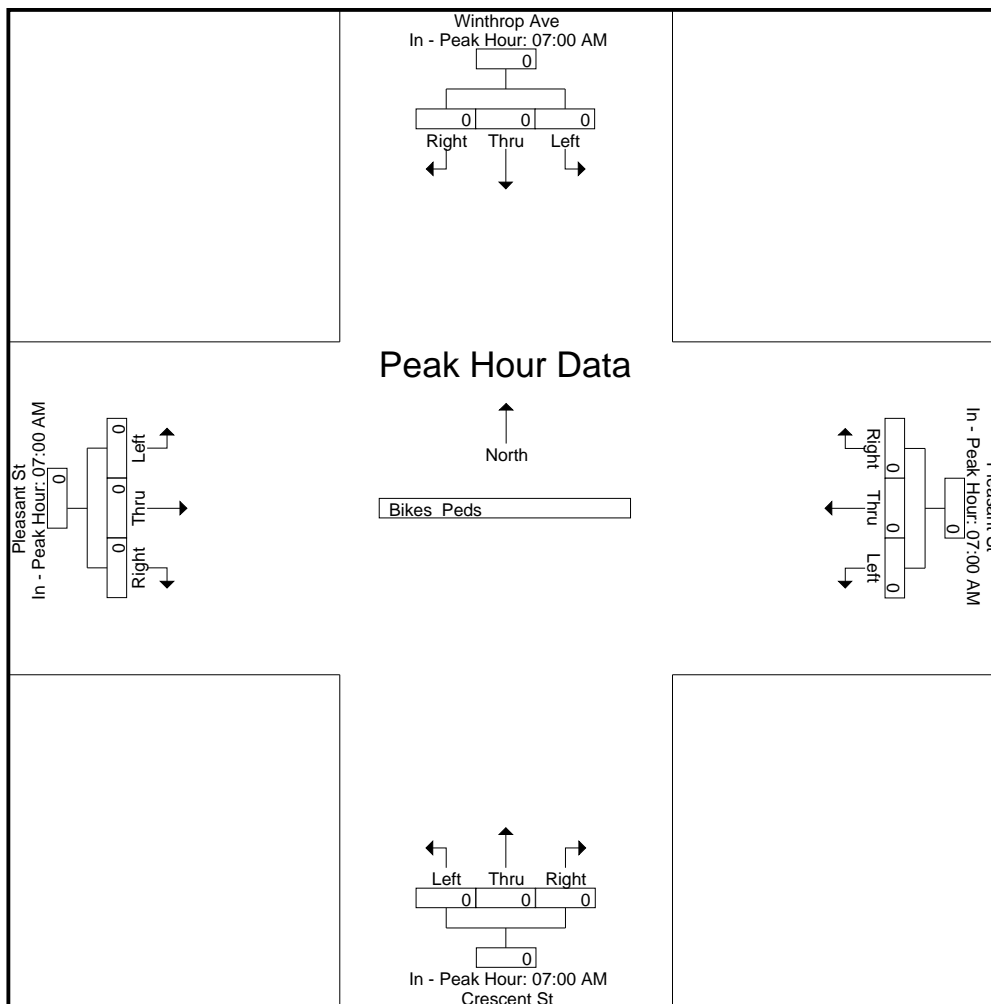

# Accurate Counts

978-664-2565

N/S Street : Winthrop Ave / Crescent St  
 E/W Street : Pleasant Street  
 City/State : Bridgewater, MA  
 Weather : Clear

File Name : 202700B9  
 Site Code : 20270009  
 Start Date : 10/2/2024  
 Page No : 1

### Groups Printed- Cars - Trucks

Start Time	Winthrop Ave From North			Pleasant St From East			Crescent St From South			Pleasant St From West			Int. Total
	Left	Thru	Right	Left	Thru	Right	Left	Thru	Right	Left	Thru	Right	
04:00 PM	0	0	2	2	153	0	31	0	1	0	125	49	363
04:15 PM	0	0	1	2	143	0	28	0	3	0	134	31	342
04:30 PM	0	0	0	4	143	0	44	1	1	1	118	40	352
04:45 PM	1	0	2	1	122	1	30	0	4	0	118	40	319
<b>Total</b>	<b>1</b>	<b>0</b>	<b>5</b>	<b>9</b>	<b>561</b>	<b>1</b>	<b>133</b>	<b>1</b>	<b>9</b>	<b>1</b>	<b>495</b>	<b>160</b>	<b>1376</b>
05:00 PM	0	0	0	7	130	0	25	0	1	0	128	48	339
05:15 PM	0	0	0	4	141	2	29	1	2	1	134	54	368
05:30 PM	0	0	0	4	126	0	18	0	1	2	130	41	322
05:45 PM	0	0	0	1	110	0	19	0	3	0	126	35	294
<b>Total</b>	<b>0</b>	<b>0</b>	<b>0</b>	<b>16</b>	<b>507</b>	<b>2</b>	<b>91</b>	<b>1</b>	<b>7</b>	<b>3</b>	<b>518</b>	<b>178</b>	<b>1323</b>
<b>Grand Total</b>	<b>1</b>	<b>0</b>	<b>5</b>	<b>25</b>	<b>1068</b>	<b>3</b>	<b>224</b>	<b>2</b>	<b>16</b>	<b>4</b>	<b>1013</b>	<b>338</b>	<b>2699</b>
Apprch %	16.7	0	83.3	2.3	97.4	0.3	92.6	0.8	6.6	0.3	74.8	24.9	
Total %	0	0	0.2	0.9	39.6	0.1	8.3	0.1	0.6	0.1	37.5	12.5	
Cars	1	0	5	25	1055	3	222	2	16	4	988	337	2658
% Cars	100	0	100	100	98.8	100	99.1	100	100	100	97.5	99.7	98.5
Trucks	0	0	0	0	13	0	2	0	0	0	25	1	41
% Trucks	0	0	0	0	1.2	0	0.9	0	0	0	2.5	0.3	1.5

Start Time	Winthrop Ave From North				Pleasant St From East				Crescent St From South				Pleasant St From West				Int. Total
	Left	Thru	Right	App. Total	Left	Thru	Right	App. Total	Left	Thru	Right	App. Total	Left	Thru	Right	App. Total	
Peak Hour Analysis From 04:00 PM to 05:45 PM - Peak 1 of 1																	
Peak Hour for Entire Intersection Begins at 04:30 PM																	
04:30 PM	0	0	0	0	4	<b>143</b>	0	<b>147</b>	<b>44</b>	<b>1</b>	<b>1</b>	<b>46</b>	<b>1</b>	118	40	159	352
04:45 PM	1	0	<b>2</b>	<b>3</b>	1	122	1	124	30	0	<b>4</b>	34	0	118	40	158	319
05:00 PM	0	0	0	0	<b>7</b>	130	0	137	25	0	1	26	0	128	48	176	339
05:15 PM	0	0	0	0	4	141	<b>2</b>	<b>147</b>	29	1	2	32	1	<b>134</b>	<b>54</b>	<b>189</b>	<b>368</b>
<b>Total Volume</b>	<b>1</b>	<b>0</b>	<b>2</b>	<b>3</b>	<b>16</b>	<b>536</b>	<b>3</b>	<b>555</b>	<b>128</b>	<b>2</b>	<b>8</b>	<b>138</b>	<b>2</b>	<b>498</b>	<b>182</b>	<b>682</b>	<b>1378</b>
% App. Total	33.3	0	66.7		2.9	96.6	0.5		92.8	1.4	5.8		0.3	73	26.7		
PHF	.250	.000	.250	.250	.571	.937	.375	.944	.727	.500	.500	.750	.500	.929	.843	.902	.936
Cars	1	0	2	3	16	531	3	550	126	2	8	136	2	485	182	669	1358
% Cars	100	0	100	100	100	99.1	100	99.1	98.4	100	100	98.6	100	97.4	100	98.1	98.5
Trucks	0	0	0	0	0	5	0	5	2	0	0	2	0	13	0	13	20
% Trucks	0	0	0	0	0	0.9	0	0.9	1.6	0	0	1.4	0	2.6	0	1.9	1.5

# Accurate Counts

978-664-2565

N/S Street : Winthrop Ave / Crescent St

E/W Street : Pleasant Street

City/State : Bridgewater, MA

Weather : Clear

File Name : 202700B9

Site Code : 20270009

Start Date : 10/2/2024

Page No : 2

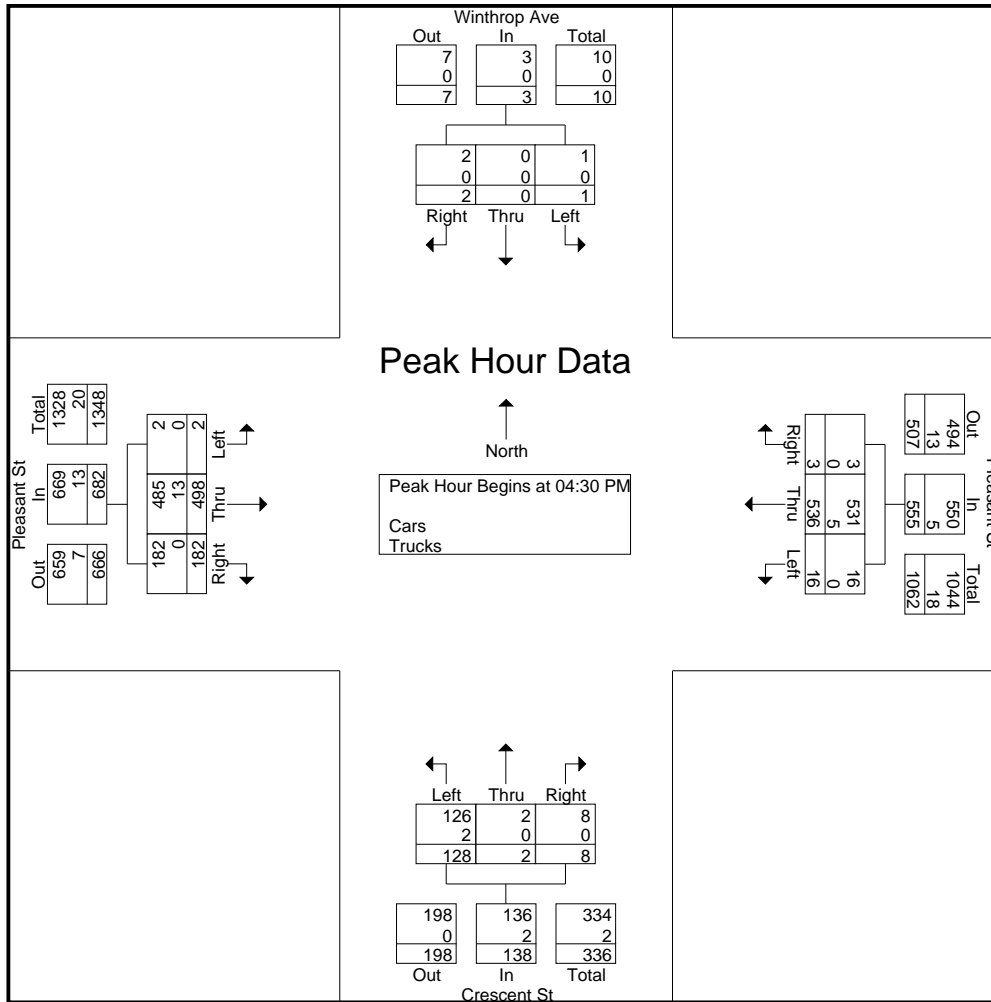

**Peak Hour Analysis From 04:00 PM to 05:45 PM - Peak 1 of 1**

**Peak Hour for Each Approach Begins at:**

	04:00 PM				04:00 PM				04:00 PM				05:00 PM			
+0 mins.	0	0	2	2	2	153	0	155	31	0	1	32	0	128	48	176
+15 mins.	0	0	1	1	2	143	0	145	28	0	3	31	1	134	54	189
+30 mins.	0	0	0	0	4	143	0	147	44	1	1	46	2	130	41	173
+45 mins.	1	0	2	3	1	122	1	124	30	0	4	34	0	126	35	161
Total Volume	1	0	5	6	9	561	1	571	133	1	9	143	3	518	178	699
% App. Total	16.7	0	83.3		1.6	98.2	0.2		93	0.7	6.3		0.4	74.1	25.5	
PHF	.250	.000	.625	.500	.563	.917	.250	.921	.756	.250	.563	.777	.375	.966	.824	.925
Cars	1	0	5	6	9	550	1	560	132	1	9	142	3	511	178	692
% Cars	100	0	100	100	100	98	100	98.1	99.2	100	100	99.3	100	98.6	100	99
Trucks	0	0	0	0	0	11	0	11	1	0	0	1	0	7	0	7
% Trucks	0	0	0	0	0	2	0	1.9	0.8	0	0	0.7	0	1.4	0	1

# Accurate Counts

978-664-2565

N/S Street : Winthrop Ave / Crescent St

E/W Street : Pleasant Street

City/State : Bridgewater, MA

Weather : Clear

File Name : 202700B9

Site Code : 20270009

Start Date : 10/2/2024

Page No : 3

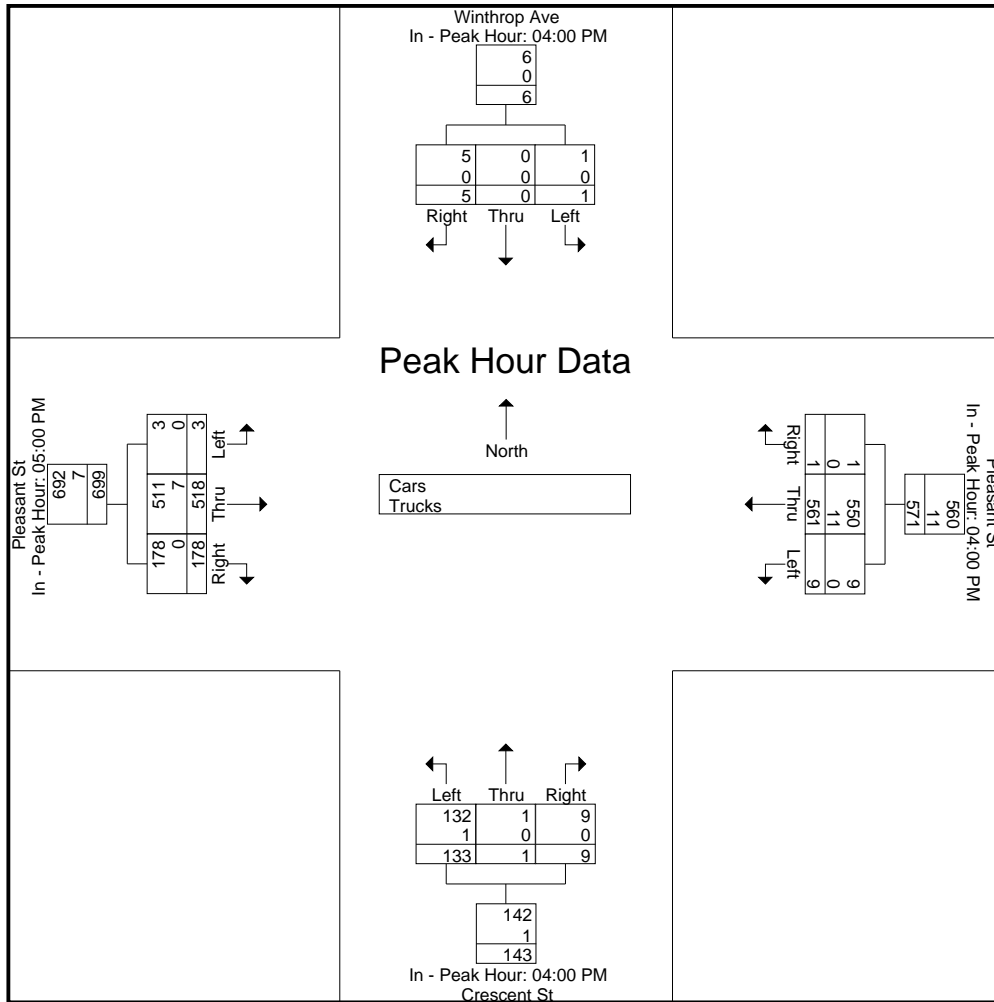

# Accurate Counts

978-664-2565

N/S Street : Winthrop Ave / Crescent St  
 E/W Street : Pleasant Street  
 City/State : Bridgewater, MA  
 Weather : Clear

File Name : 202700B9  
 Site Code : 20270009  
 Start Date : 10/2/2024  
 Page No : 4

## Groups Printed- Cars

Start Time	Winthrop Ave From North			Pleasant St From East			Crescent St From South			Pleasant St From West			Int. Total
	Left	Thru	Right	Left	Thru	Right	Left	Thru	Right	Left	Thru	Right	
04:00 PM	0	0	2	2	151	0	31	0	1	0	122	49	358
04:15 PM	0	0	1	2	137	0	28	0	3	0	128	30	329
04:30 PM	0	0	0	4	142	0	44	1	1	1	112	40	345
04:45 PM	1	0	2	1	120	1	29	0	4	0	115	40	313
<b>Total</b>	<b>1</b>	<b>0</b>	<b>5</b>	<b>9</b>	<b>550</b>	<b>1</b>	<b>132</b>	<b>1</b>	<b>9</b>	<b>1</b>	<b>477</b>	<b>159</b>	<b>1345</b>
05:00 PM	0	0	0	7	130	0	24	0	1	0	125	48	335
05:15 PM	0	0	0	4	139	2	29	1	2	1	133	54	365
05:30 PM	0	0	0	4	126	0	18	0	1	2	128	41	320
05:45 PM	0	0	0	1	110	0	19	0	3	0	125	35	293
<b>Total</b>	<b>0</b>	<b>0</b>	<b>0</b>	<b>16</b>	<b>505</b>	<b>2</b>	<b>90</b>	<b>1</b>	<b>7</b>	<b>3</b>	<b>511</b>	<b>178</b>	<b>1313</b>
<b>Grand Total</b>	<b>1</b>	<b>0</b>	<b>5</b>	<b>25</b>	<b>1055</b>	<b>3</b>	<b>222</b>	<b>2</b>	<b>16</b>	<b>4</b>	<b>988</b>	<b>337</b>	<b>2658</b>
Apprch %	16.7	0	83.3	2.3	97.4	0.3	92.5	0.8	6.7	0.3	74.3	25.4	
Total %	0	0	0.2	0.9	39.7	0.1	8.4	0.1	0.6	0.2	37.2	12.7	

Start Time	Winthrop Ave From North				Pleasant St From East				Crescent St From South				Pleasant St From West				Int. Total
	Left	Thru	Right	App. Total	Left	Thru	Right	App. Total	Left	Thru	Right	App. Total	Left	Thru	Right	App. Total	
<b>Peak Hour Analysis From 04:00 PM to 05:45 PM - Peak 1 of 1</b>																	
<b>Peak Hour for Entire Intersection Begins at 04:30 PM</b>																	
04:30 PM	0	0	0	0	4	<b>142</b>	0	<b>146</b>	<b>44</b>	<b>1</b>	<b>1</b>	<b>46</b>	<b>1</b>	112	40	153	345
04:45 PM	<b>1</b>	0	<b>2</b>	<b>3</b>	1	120	1	122	29	0	<b>4</b>	33	0	115	40	155	313
05:00 PM	0	0	0	0	<b>7</b>	130	0	137	24	0	1	25	0	125	48	173	335
05:15 PM	0	0	0	0	4	139	<b>2</b>	145	29	1	2	32	<b>1</b>	<b>133</b>	<b>54</b>	<b>188</b>	<b>365</b>
<b>Total Volume</b>	<b>1</b>	<b>0</b>	<b>2</b>	<b>3</b>	<b>16</b>	<b>531</b>	<b>3</b>	<b>550</b>	<b>126</b>	<b>2</b>	<b>8</b>	<b>136</b>	<b>2</b>	<b>485</b>	<b>182</b>	<b>669</b>	<b>1358</b>
<b>% App. Total</b>	<b>33.3</b>	<b>0</b>	<b>66.7</b>		<b>2.9</b>	<b>96.5</b>	<b>0.5</b>		<b>92.6</b>	<b>1.5</b>	<b>5.9</b>		<b>0.3</b>	<b>72.5</b>	<b>27.2</b>		
PHF	.250	.000	.250	.250	.571	.935	.375	.942	.716	.500	.500	.739	.500	.912	.843	.890	.930



# Accurate Counts

978-664-2565

N/S Street : Winthrop Ave / Crescent St

E/W Street : Pleasant Street

City/State : Bridgewater, MA

Weather : Clear

File Name : 202700B9

Site Code : 20270009

Start Date : 10/2/2024

Page No : 5

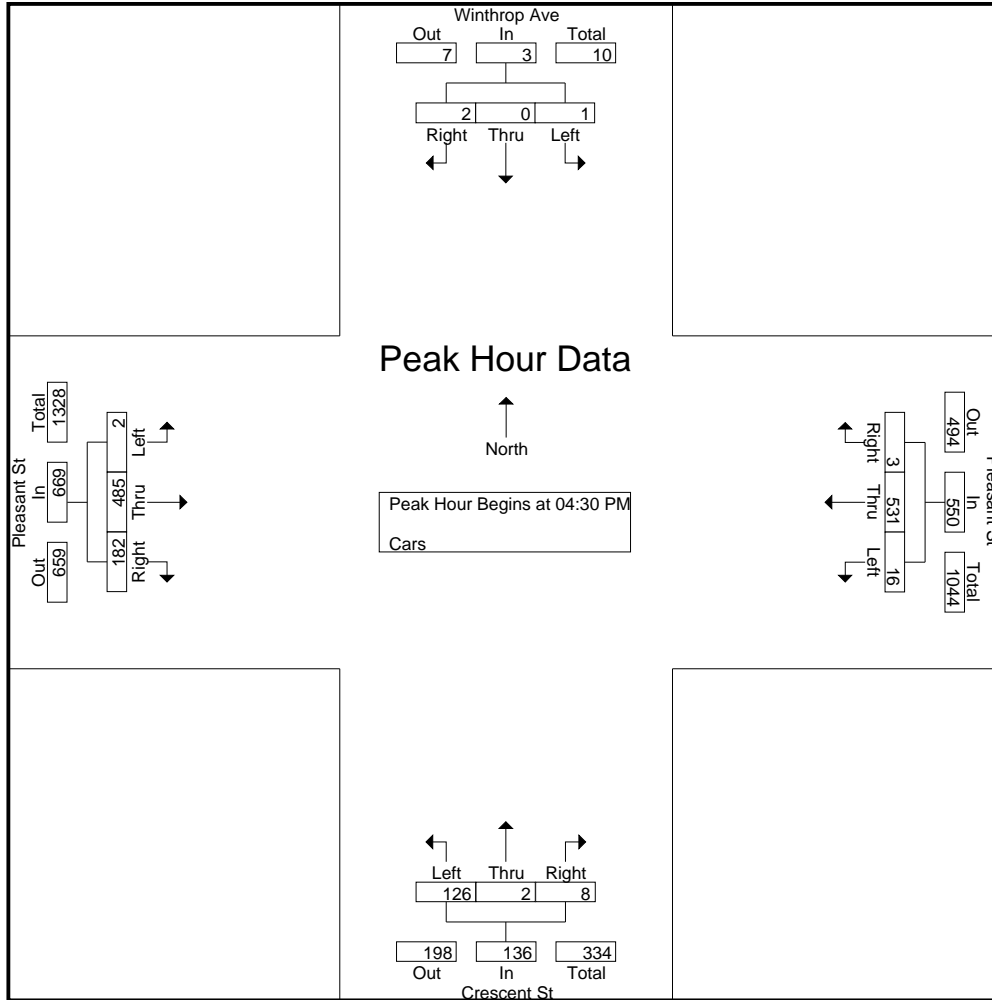

**Peak Hour Analysis From 04:00 PM to 05:45 PM - Peak 1 of 1**

**Peak Hour for Each Approach Begins at:**

	04:00 PM				04:00 PM				04:00 PM				05:00 PM			
+0 mins.	0	0	2	2	2	151	0	153	31	0	1	32	0	125	48	173
+15 mins.	0	0	1	1	2	137	0	139	28	0	3	31	1	133	54	188
+30 mins.	0	0	0	0	4	142	0	146	44	1	1	46	2	128	41	171
+45 mins.	1	0	2	3	1	120	1	122	29	0	4	33	0	125	35	160
Total Volume	1	0	5	6	9	550	1	560	132	1	9	142	3	511	178	692
% App. Total	16.7	0	83.3		1.6	98.2	0.2		93	0.7	6.3		0.4	73.8	25.7	
PHF	.250	.000	.625	.500	.563	.911	.250	.915	.750	.250	.563	.772	.375	.961	.824	.920

# Accurate Counts

978-664-2565

File Name : 202700B9

Site Code : 20270009

Start Date : 10/2/2024

Page No : 6

N/S Street : Winthrop Ave / Crescent St

E/W Street : Pleasant Street

City/State : Bridgewater, MA

Weather : Clear

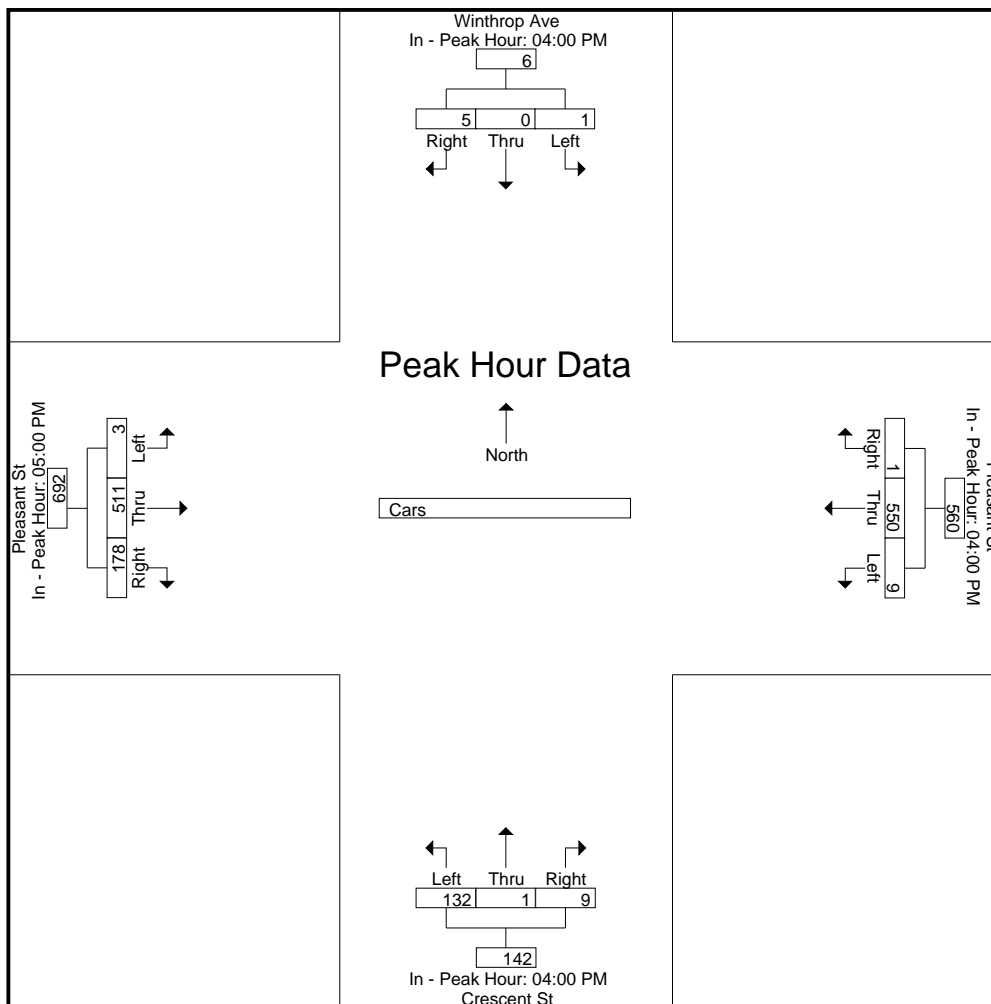

# Accurate Counts

978-664-2565

N/S Street : Winthrop Ave / Crescent St  
 E/W Street : Pleasant Street  
 City/State : Bridgewater, MA  
 Weather : Clear

File Name : 202700B9  
 Site Code : 20270009  
 Start Date : 10/2/2024  
 Page No : 7

### Groups Printed- Trucks

Start Time	Winthrop Ave From North			Pleasant St From East			Crescent St From South			Pleasant St From West			Int. Total
	Left	Thru	Right	Left	Thru	Right	Left	Thru	Right	Left	Thru	Right	
04:00 PM	0	0	0	0	2	0	0	0	0	0	3	0	5
04:15 PM	0	0	0	0	6	0	0	0	0	0	6	1	13
04:30 PM	0	0	0	0	1	0	0	0	0	0	6	0	7
04:45 PM	0	0	0	0	2	0	1	0	0	0	3	0	6
<b>Total</b>	0	0	0	0	11	0	1	0	0	0	18	1	31
05:00 PM	0	0	0	0	0	0	1	0	0	0	3	0	4
05:15 PM	0	0	0	0	2	0	0	0	0	0	1	0	3
05:30 PM	0	0	0	0	0	0	0	0	0	0	2	0	2
05:45 PM	0	0	0	0	0	0	0	0	0	0	1	0	1
<b>Total</b>	0	0	0	0	2	0	1	0	0	0	7	0	10
<b>Grand Total</b>	0	0	0	0	13	0	2	0	0	0	25	1	41
Apprch %	0	0	0	0	100	0	100	0	0	0	96.2	3.8	
Total %	0	0	0	0	31.7	0	4.9	0	0	0	61	2.4	

Start Time	Winthrop Ave From North				Pleasant St From East				Crescent St From South				Pleasant St From West				Int. Total	
	Left	Thru	Right	App. Total	Left	Thru	Right	App. Total	Left	Thru	Right	App. Total	Left	Thru	Right	App. Total		
<b>Peak Hour Analysis From 04:00 PM to 05:45 PM - Peak 1 of 1</b>																		
<b>Peak Hour for Entire Intersection Begins at 04:00 PM</b>																		
04:00 PM	0	0	0	0	0	2	0	2	0	0	0	0	0	0	3	0	3	5
04:15 PM	0	0	0	0	0	6	0	6	0	0	0	0	0	0	6	1	7	13
04:30 PM	0	0	0	0	0	1	0	1	0	0	0	0	0	0	6	0	6	7
04:45 PM	0	0	0	0	0	2	0	2	1	0	0	1	0	0	3	0	3	6
<b>Total Volume</b>	0	0	0	0	0	11	0	11	1	0	0	1	0	0	18	1	19	31
<b>% App. Total</b>	0	0	0	0	0	100	0	100	100	0	0	0	0	94.7	5.3			
<b>PHF</b>	.000	.000	.000	.000	.000	.458	.000	.458	.250	.000	.000	.250	.000	.750	.250	.679	.596	

# Accurate Counts

978-664-2565

N/S Street : Winthrop Ave / Crescent St

E/W Street : Pleasant Street

City/State : Bridgewater, MA

Weather : Clear

File Name : 202700B9

Site Code : 20270009

Start Date : 10/2/2024

Page No : 8

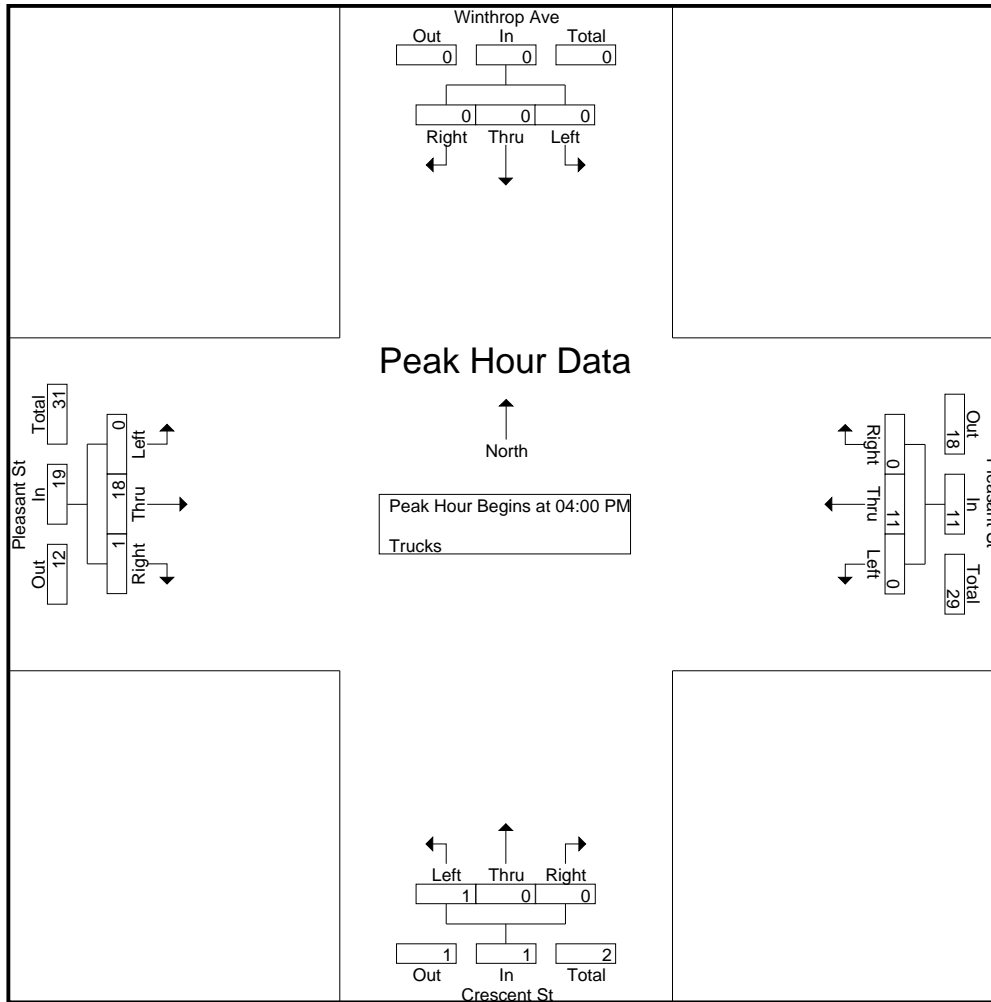

**Peak Hour Analysis From 04:00 PM to 05:45 PM - Peak 1 of 1**

Peak Hour for Each Approach Begins at:

	04:00 PM				04:00 PM				04:15 PM				04:00 PM			
+0 mins.	0	0	0	0	0	2	0	2	0	0	0	0	0	3	0	3
+15 mins.	0	0	0	0	0	<b>6</b>	0	<b>6</b>	0	0	0	0	0	<b>6</b>	<b>1</b>	<b>7</b>
+30 mins.	0	0	0	0	0	1	0	1	<b>1</b>	0	0	<b>1</b>	0	6	0	6
+45 mins.	0	0	0	0	0	2	0	2	1	0	0	1	0	3	0	3
Total Volume	0	0	0	0	0	11	0	11	2	0	0	2	0	18	1	19
% App. Total	0	0	0	0	0	100	0	100	100	0	0	100	0	94.7	5.3	100
PHF	.000	.000	.000	.000	.000	.458	.000	.458	.500	.000	.000	.500	.000	.750	.250	.679

# Accurate Counts

978-664-2565

File Name : 202700B9

Site Code : 20270009

Start Date : 10/2/2024

Page No : 9

N/S Street : Winthrop Ave / Crescent St

E/W Street : Pleasant Street

City/State : Bridgewater, MA

Weather : Clear

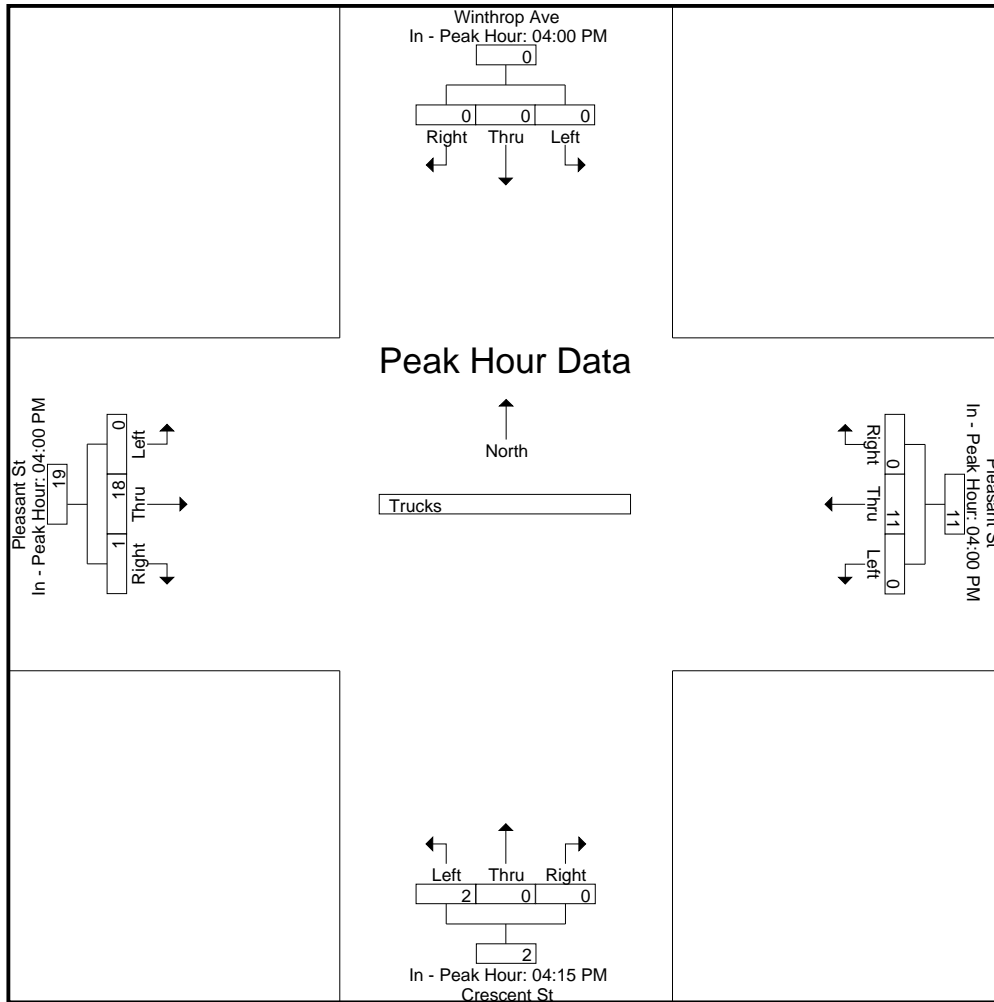

# Accurate Counts

978-664-2565

N/S Street : Winthrop Ave / Crescent St

E/W Street : Pleasant Street

City/State : Bridgewater, MA

Weather : Clear

File Name : 202700B9

Site Code : 20270009

Start Date : 10/2/2024

Page No : 10

## Groups Printed- Bikes Peds

Start Time	Winthrop Ave From North				Pleasant St From East				Crescent St From South				Pleasant St From West				Exclu. Total	Inclu. Total	Int. Total
	Left	Thru	Right	Peds	Left	Thru	Right	Peds	Left	Thru	Right	Peds	Left	Thru	Right	Peds			
04:00 PM	0	0	0	3	0	0	0	0	0	0	0	0	0	0	0	0	3	0	3
04:15 PM	0	0	0	1	0	0	0	1	0	0	0	0	0	0	0	0	2	0	2
04:30 PM	0	0	0	0	0	0	0	0	0	0	0	0	0	2	0	0	0	2	2
04:45 PM	0	0	0	3	0	0	0	0	0	0	0	0	0	0	0	0	3	0	3
<b>Total</b>	0	0	0	7	0	0	0	1	0	0	0	0	0	2	0	0	8	2	10
05:00 PM	0	0	0	1	0	0	0	3	0	0	0	0	0	0	0	0	4	0	4
05:15 PM	0	0	0	0	0	0	0	0	0	0	0	0	0	0	0	0	0	0	0
05:30 PM	0	0	0	1	0	0	0	0	0	0	0	0	0	0	0	0	1	0	1
05:45 PM	0	0	0	1	0	0	0	0	0	0	0	0	0	0	0	0	1	0	1
<b>Total</b>	0	0	0	3	0	0	0	3	0	0	0	0	0	0	0	0	6	0	6
<b>Grand Total</b>	0	0	0	10	0	0	0	4	0	0	0	0	0	2	0	0	14	2	16
Apprch %	0	0	0		0	0	0		0	0	0		0	100	0				
Total %	0	0	0		0	0	0		0	0	0		0	100	0		87.5	12.5	

Start Time	Winthrop Ave From North				Pleasant St From East				Crescent St From South				Pleasant St From West				Int. Total	
	Left	Thru	Right	App. Total	Left	Thru	Right	App. Total	Left	Thru	Right	App. Total	Left	Thru	Right	App. Total		
<b>Peak Hour Analysis From 04:00 PM to 05:45 PM - Peak 1 of 1</b>																		
<b>Peak Hour for Entire Intersection Begins at 04:00 PM</b>																		
04:00 PM	0	0	0	0	0	0	0	0	0	0	0	0	0	0	0	0	0	0
04:15 PM	0	0	0	0	0	0	0	0	0	0	0	0	0	0	0	0	0	0
04:30 PM	0	0	0	0	0	0	0	0	0	0	0	0	0	0	2	0	2	2
04:45 PM	0	0	0	0	0	0	0	0	0	0	0	0	0	0	0	0	0	0
<b>Total Volume</b>	0	0	0	0	0	0	0	0	0	0	0	0	0	0	2	0	2	2
<b>% App. Total</b>	0	0	0		0	0	0		0	0	0		0	100	0			
<b>PHF</b>	.000	.000	.000	.000	.000	.000	.000	.000	.000	.000	.000	.000	.000	.250	.000	.250		.250

# Accurate Counts

978-664-2565

N/S Street : Winthrop Ave / Crescent St

E/W Street : Pleasant Street

City/State : Bridgewater, MA

Weather : Clear

File Name : 202700B9

Site Code : 20270009

Start Date : 10/2/2024

Page No : 11

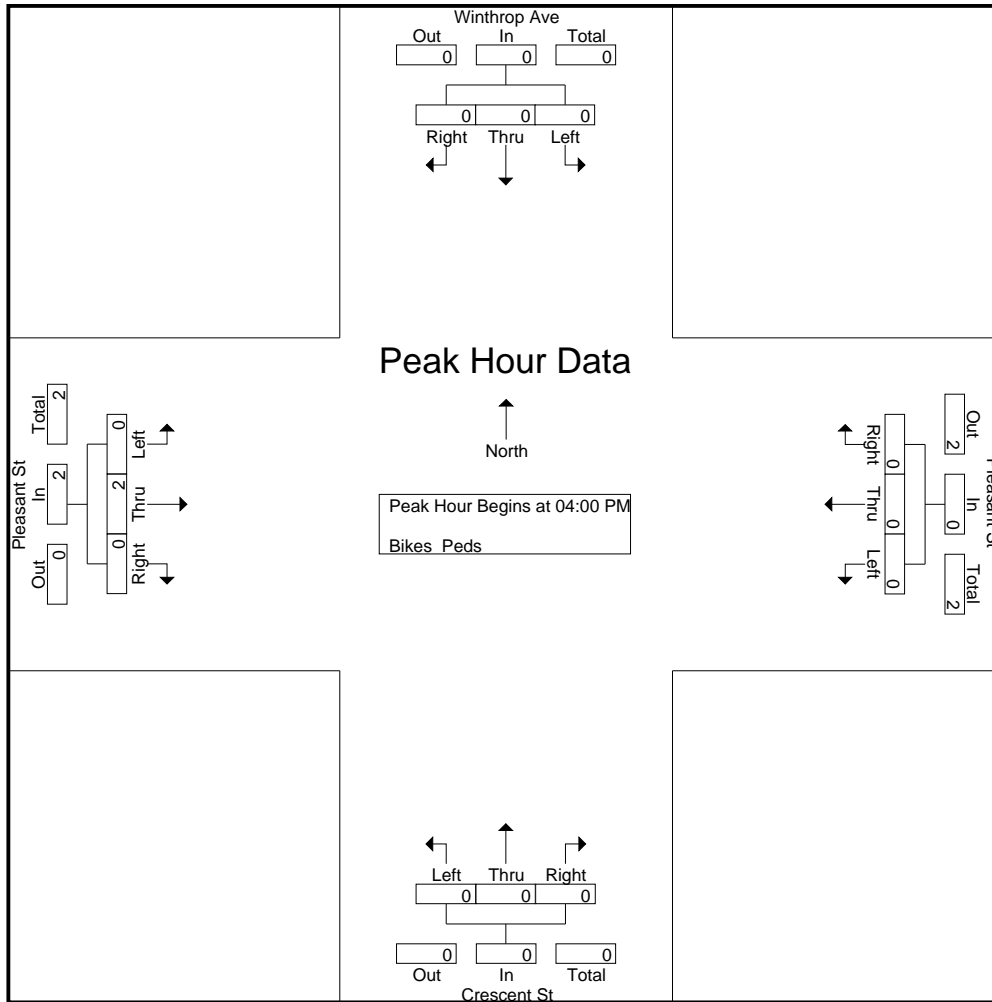

**Peak Hour Analysis From 04:00 PM to 05:45 PM - Peak 1 of 1**

**Peak Hour for Each Approach Begins at:**

	04:00 PM				04:00 PM				04:00 PM				04:00 PM			
+0 mins.	0	0	0	0	0	0	0	0	0	0	0	0	0	0	0	0
+15 mins.	0	0	0	0	0	0	0	0	0	0	0	0	0	0	0	0
+30 mins.	0	0	0	0	0	0	0	0	0	0	0	0	0	2	0	2
+45 mins.	0	0	0	0	0	0	0	0	0	0	0	0	0	0	0	0
<b>Total Volume</b>	0	0	0	0	0	0	0	0	0	0	0	0	0	2	0	2
<b>% App. Total</b>	0	0	0	0	0	0	0	0	0	0	0	0	0	100	0	0
<b>PHF</b>	.000	.000	.000	.000	.000	.000	.000	.000	.000	.000	.000	.000	.000	.250	.000	.250

# Accurate Counts

978-664-2565

N/S Street : Winthrop Ave / Crescent St

E/W Street : Pleasant Street

City/State : Bridgewater, MA

Weather : Clear

File Name : 202700B9

Site Code : 20270009

Start Date : 10/2/2024

Page No : 12

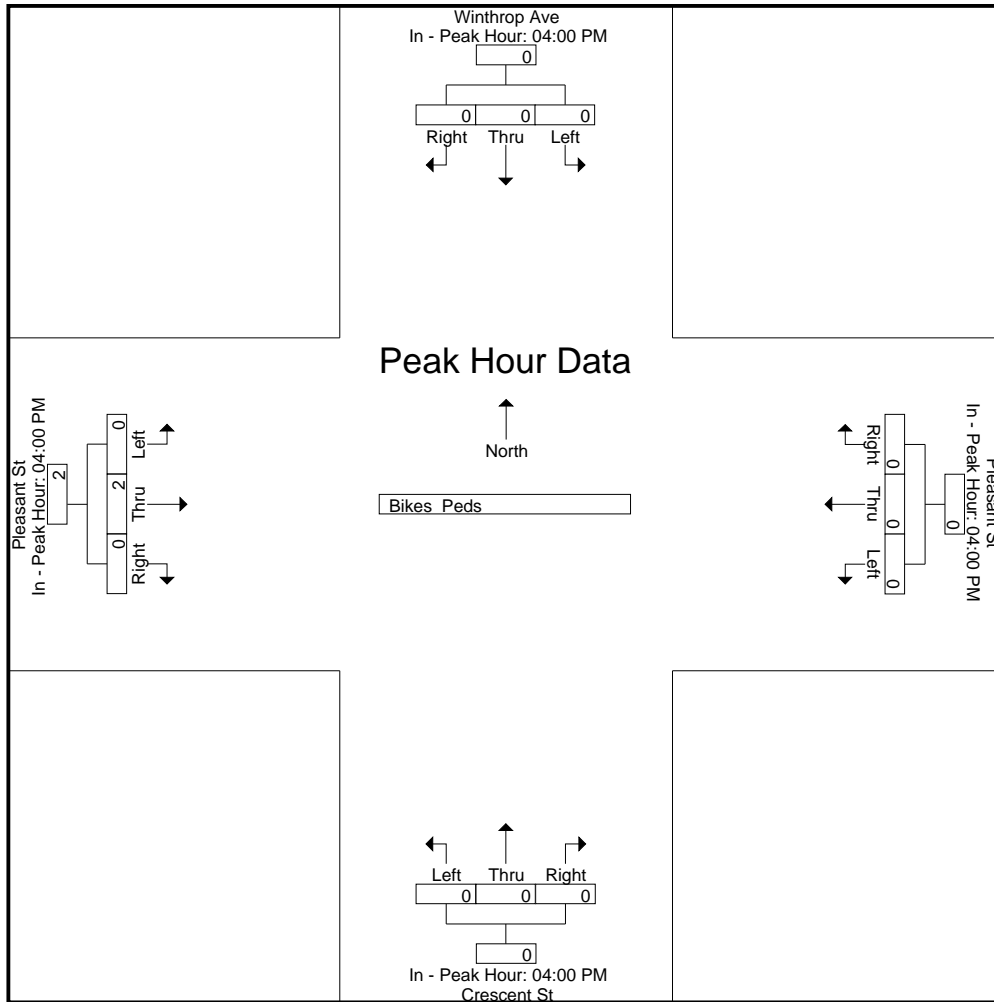



# Accurate Counts

978-664-2565

N/S Street : South Street  
 E/W Street : Pleasant Street  
 City/State : Bridgewater, MA  
 Weather : Clear

File Name : 20270B10  
 Site Code : 20270010  
 Start Date : 10/2/2024  
 Page No : 1

### Groups Printed- Cars - Trucks

Start Time	South St From North		South St From South		Pleasant St From West		Int. Total
	Thru	Right	Left	Thru	Left	Right	
07:00 AM	18	114	11	59	82	4	288
07:15 AM	28	115	6	47	98	5	299
07:30 AM	40	106	7	59	106	5	323
07:45 AM	32	115	7	52	104	4	314
<b>Total</b>	<b>118</b>	<b>450</b>	<b>31</b>	<b>217</b>	<b>390</b>	<b>18</b>	<b>1224</b>
08:00 AM	54	115	17	55	79	9	329
08:15 AM	58	86	5	42	101	3	295
08:30 AM	59	71	11	41	95	3	280
08:45 AM	65	83	23	83	70	10	334
<b>Total</b>	<b>236</b>	<b>355</b>	<b>56</b>	<b>221</b>	<b>345</b>	<b>25</b>	<b>1238</b>
<b>Grand Total</b>	<b>354</b>	<b>805</b>	<b>87</b>	<b>438</b>	<b>735</b>	<b>43</b>	<b>2462</b>
Apprch %	30.5	69.5	16.6	83.4	94.5	5.5	
Total %	14.4	32.7	3.5	17.8	29.9	1.7	
Cars	340	765	82	438	684	42	2351
% Cars	96	95	94.3	100	93.1	97.7	95.5
Trucks	14	40	5	0	51	1	111
% Trucks	4	5	5.7	0	6.9	2.3	4.5

Start Time	South St From North			South St From South			Pleasant St From West			Int. Total
	Thru	Right	App. Total	Left	Thru	App. Total	Left	Right	App. Total	
<b>Peak Hour Analysis From 07:00 AM to 08:45 AM - Peak 1 of 1</b>										
<b>Peak Hour for Entire Intersection Begins at 07:15 AM</b>										
07:15 AM	28	<b>115</b>	143	6	47	53	98	5	103	299
07:30 AM	40	106	146	7	<b>59</b>	66	<b>106</b>	5	<b>111</b>	323
07:45 AM	32	115	147	7	52	59	104	4	108	314
08:00 AM	<b>54</b>	115	<b>169</b>	<b>17</b>	55	<b>72</b>	79	<b>9</b>	<b>88</b>	<b>329</b>
<b>Total Volume</b>	<b>154</b>	<b>451</b>	<b>605</b>	<b>37</b>	<b>213</b>	<b>250</b>	<b>387</b>	<b>23</b>	<b>410</b>	<b>1265</b>
% App. Total	25.5	74.5		14.8	85.2		94.4	5.6		
PHF	.713	.980	.895	.544	.903	.868	.913	.639	.923	.961
Cars	151	431	582	36	213	249	364	22	386	1217
% Cars	98.1	95.6	96.2	97.3	100	99.6	94.1	95.7	94.1	96.2
Trucks	3	20	23	1	0	1	23	1	24	48
% Trucks	1.9	4.4	3.8	2.7	0	0.4	5.9	4.3	5.9	3.8

# Accurate Counts

978-664-2565

File Name : 20270B10

Site Code : 20270010

Start Date : 10/2/2024

Page No : 2

N/S Street : South Street  
 E/W Street : Pleasant Street  
 City/State : Bridgewater, MA  
 Weather : Clear

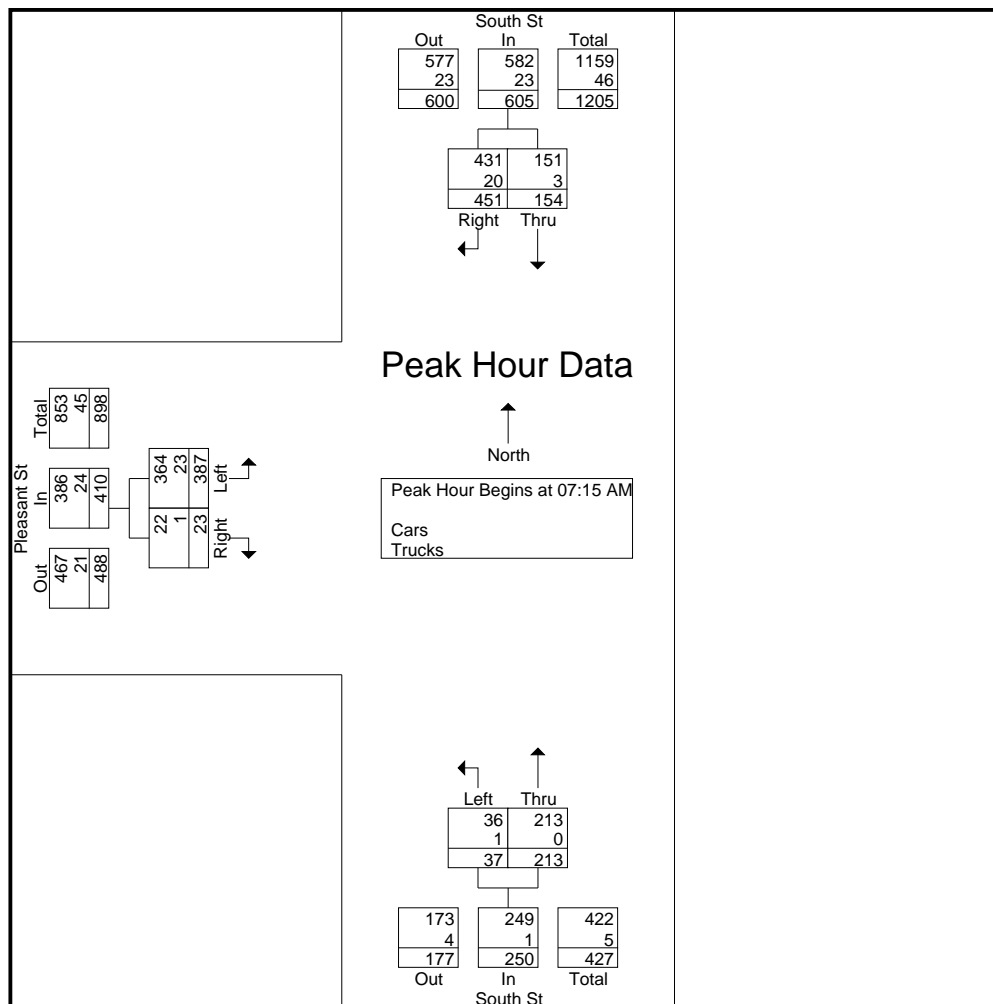

**Peak Hour Analysis From 07:00 AM to 08:45 AM - Peak 1 of 1**

Peak Hour for Each Approach Begins at:

	07:30 AM			08:00 AM			07:30 AM		
+0 mins.	40	106	146	17	55	72	<b>106</b>	5	<b>111</b>
+15 mins.	32	<b>115</b>	147	5	42	47	104	4	108
+30 mins.	54	115	<b>169</b>	11	41	52	79	<b>9</b>	88
+45 mins.	<b>58</b>	86	144	<b>23</b>	<b>83</b>	<b>106</b>	101	3	104
Total Volume	184	422	606	56	221	277	390	21	411
% App. Total	30.4	69.6		20.2	79.8		94.9	5.1	
PHF	.793	.917	.896	.609	.666	.653	.920	.583	.926
Cars	179	395	574	52	221	273	366	20	386
% Cars	97.3	93.6	94.7	92.9	100	98.6	93.8	95.2	93.9
Trucks	5	27	32	4	0	4	24	1	25
% Trucks	2.7	6.4	5.3	7.1	0	1.4	6.2	4.8	6.1

# Accurate Counts

978-664-2565

N/S Street : South Street  
 E/W Street : Pleasant Street  
 City/State : Bridgewater, MA  
 Weather : Clear

File Name : 20270B10  
 Site Code : 20270010  
 Start Date : 10/2/2024  
 Page No : 3

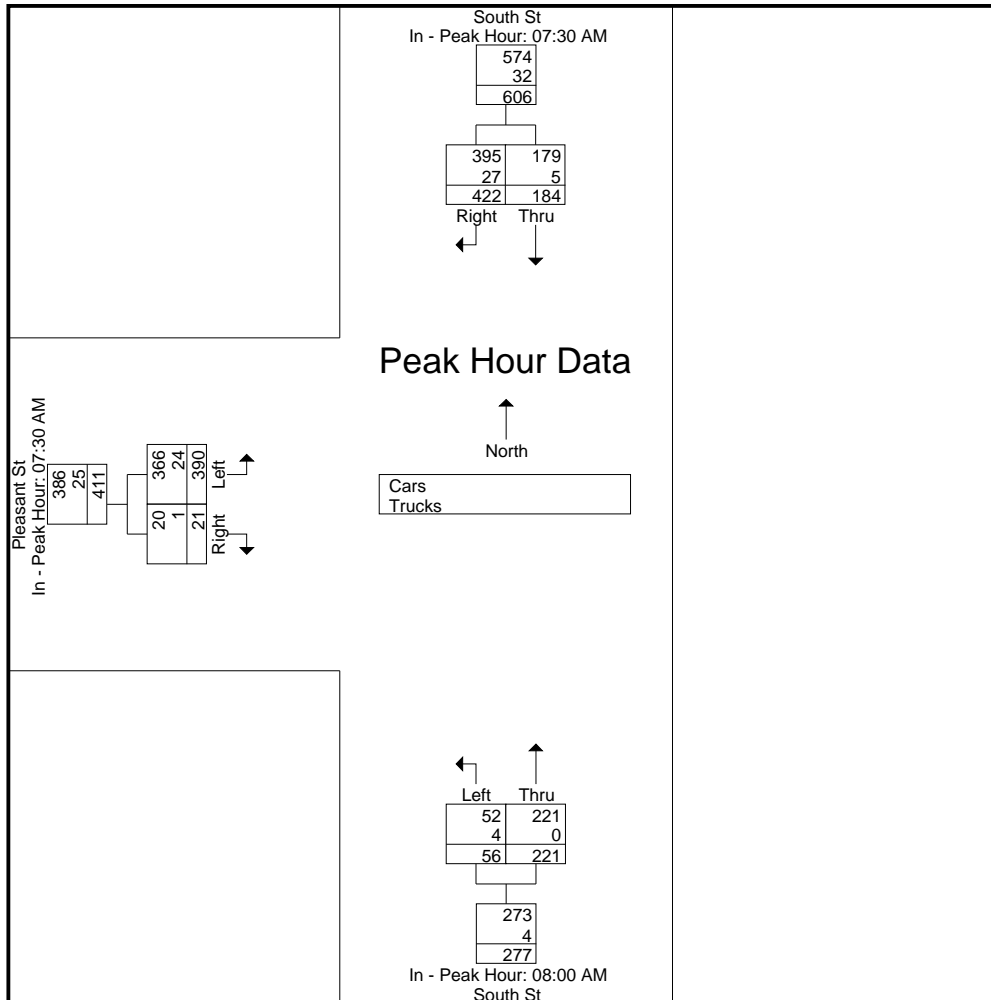

# Accurate Counts

978-664-2565

N/S Street : South Street  
 E/W Street : Pleasant Street  
 City/State : Bridgewater, MA  
 Weather : Clear

File Name : 20270B10  
 Site Code : 20270010  
 Start Date : 10/2/2024  
 Page No : 4

### Groups Printed- Cars

Start Time	South St From North		South St From South		Pleasant St From West		Int. Total
	Thru	Right	Left	Thru	Left	Right	
07:00 AM	18	107	10	59	76	4	274
07:15 AM	28	113	6	47	93	5	292
07:30 AM	37	103	7	59	97	5	308
07:45 AM	32	107	7	52	100	4	302
<b>Total</b>	<b>115</b>	<b>430</b>	<b>30</b>	<b>217</b>	<b>366</b>	<b>18</b>	<b>1176</b>
08:00 AM	54	108	16	55	74	8	315
08:15 AM	56	77	5	42	95	3	278
08:30 AM	58	68	11	41	86	3	267
08:45 AM	57	82	20	83	63	10	315
<b>Total</b>	<b>225</b>	<b>335</b>	<b>52</b>	<b>221</b>	<b>318</b>	<b>24</b>	<b>1175</b>
<b>Grand Total</b>	<b>340</b>	<b>765</b>	<b>82</b>	<b>438</b>	<b>684</b>	<b>42</b>	<b>2351</b>
Apprch %	30.8	69.2	15.8	84.2	94.2	5.8	
Total %	14.5	32.5	3.5	18.6	29.1	1.8	

Start Time	South St From North			South St From South			Pleasant St From West			Int. Total
	Thru	Right	App. Total	Left	Thru	App. Total	Left	Right	App. Total	
Peak Hour Analysis From 07:00 AM to 08:45 AM - Peak 1 of 1										
Peak Hour for Entire Intersection Begins at 07:15 AM										
07:15 AM	28	<b>113</b>	141	6	47	53	93	5	98	292
07:30 AM	37	103	140	7	<b>59</b>	66	97	5	102	308
07:45 AM	32	107	139	7	52	59	<b>100</b>	4	<b>104</b>	302
08:00 AM	<b>54</b>	108	<b>162</b>	<b>16</b>	55	<b>71</b>	74	<b>8</b>	82	<b>315</b>
Total Volume	151	431	582	36	213	249	364	22	386	1217
% App. Total	25.9	74.1		14.5	85.5		94.3	5.7		
PHF	.699	.954	.898	.563	.903	.877	.910	.688	.928	.966

# Accurate Counts

978-664-2565

N/S Street : South Street  
 E/W Street : Pleasant Street  
 City/State : Bridgewater, MA  
 Weather : Clear

File Name : 20270B10  
 Site Code : 20270010  
 Start Date : 10/2/2024  
 Page No : 5

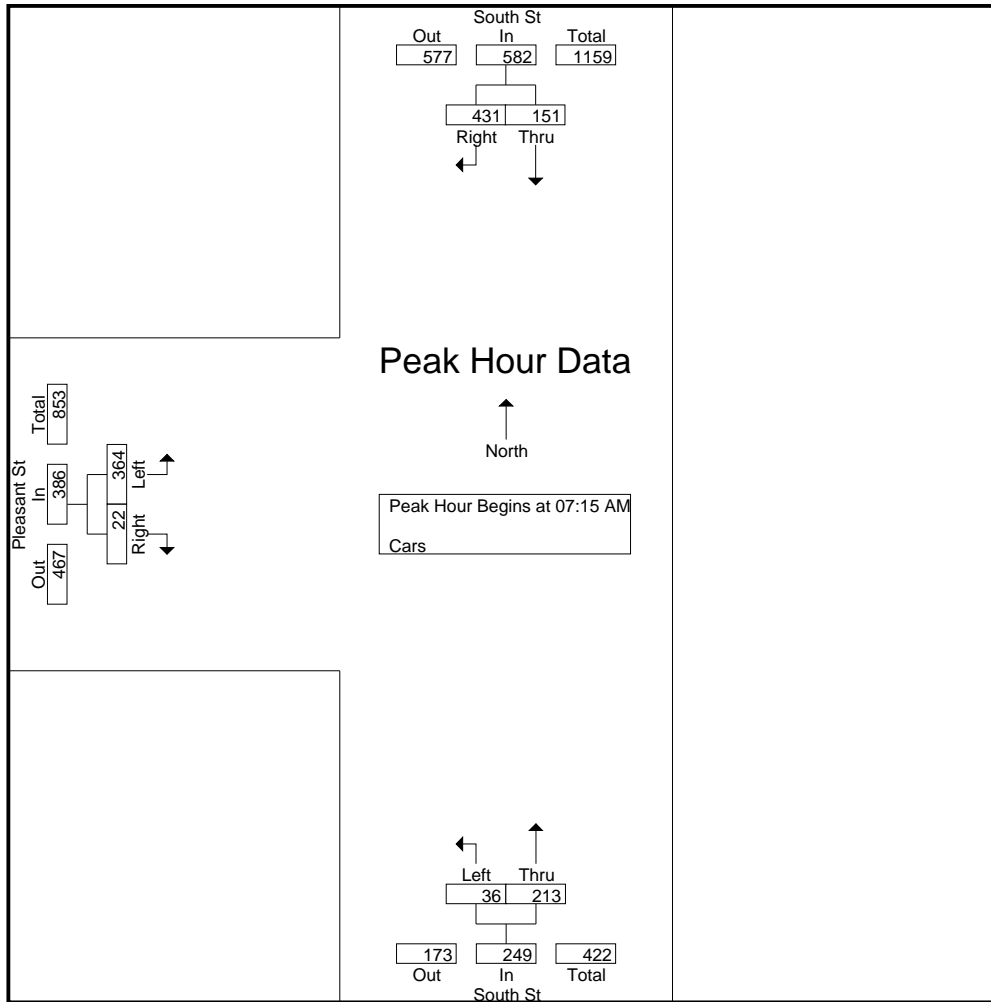

**Peak Hour Analysis From 07:00 AM to 08:45 AM - Peak 1 of 1**

Peak Hour for Each Approach Begins at:

	07:15 AM			08:00 AM			07:15 AM		
+0 mins.	28	<b>113</b>	141	16	55	71	93	5	98
+15 mins.	37	103	140	5	42	47	97	5	102
+30 mins.	32	107	139	11	41	52	<b>100</b>	4	<b>104</b>
+45 mins.	<b>54</b>	108	<b>162</b>	<b>20</b>	<b>83</b>	<b>103</b>	74	<b>8</b>	82
Total Volume	151	431	582	52	221	273	364	22	386
% App. Total	25.9	74.1		19	81		94.3	5.7	
PHF	.699	.954	.898	.650	.666	.663	.910	.688	.928

# Accurate Counts

978-664-2565

File Name : 20270B10

Site Code : 20270010

Start Date : 10/2/2024

Page No : 6

N/S Street : South Street  
E/W Street : Pleasant Street  
City/State : Bridgewater, MA  
Weather : Clear

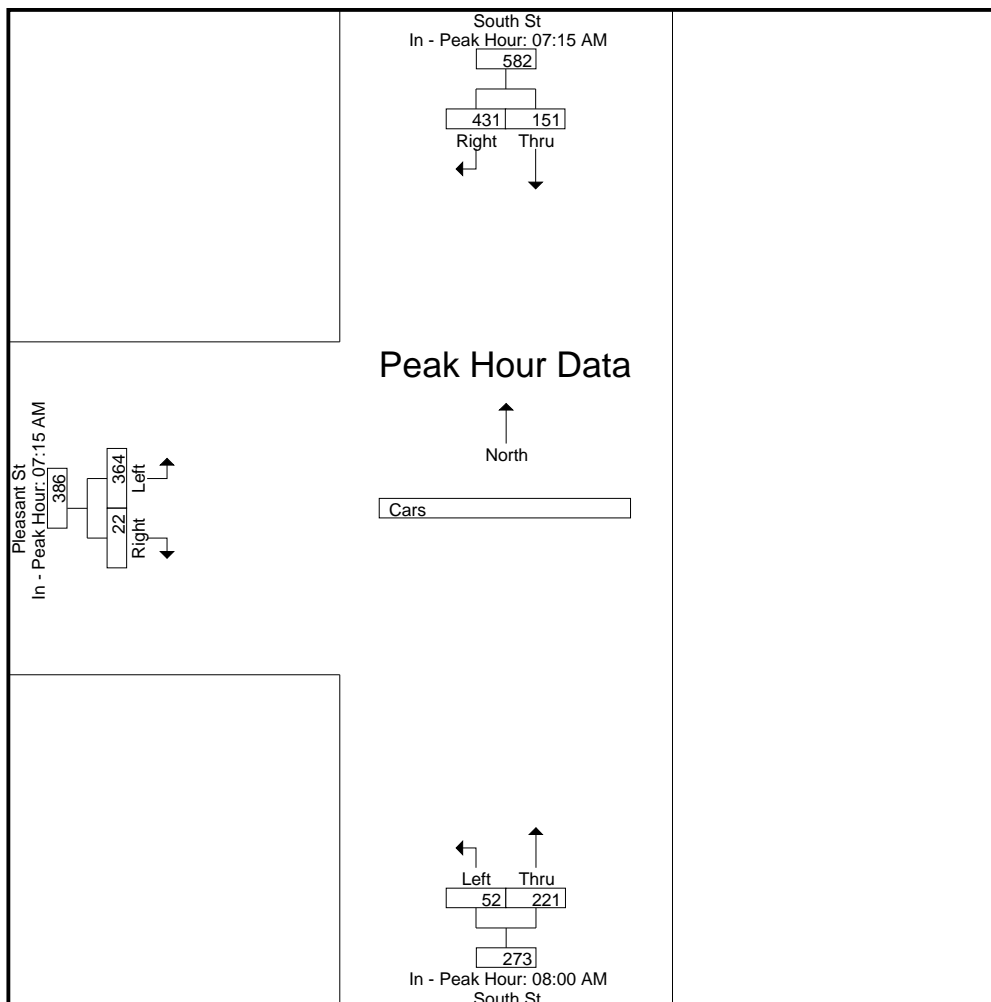

# Accurate Counts

978-664-2565

N/S Street : South Street  
 E/W Street : Pleasant Street  
 City/State : Bridgewater, MA  
 Weather : Clear

File Name : 20270B10  
 Site Code : 20270010  
 Start Date : 10/2/2024  
 Page No : 7

### Groups Printed- Trucks

Start Time	South St From North		South St From South		Pleasant St From West		Int. Total
	Thru	Right	Left	Thru	Left	Right	
07:00 AM	0	7	1	0	6	0	14
07:15 AM	0	2	0	0	5	0	7
07:30 AM	3	3	0	0	9	0	15
07:45 AM	0	8	0	0	4	0	12
<b>Total</b>	<b>3</b>	<b>20</b>	<b>1</b>	<b>0</b>	<b>24</b>	<b>0</b>	<b>48</b>
08:00 AM	0	7	1	0	5	1	14
08:15 AM	2	9	0	0	6	0	17
08:30 AM	1	3	0	0	9	0	13
08:45 AM	8	1	3	0	7	0	19
<b>Total</b>	<b>11</b>	<b>20</b>	<b>4</b>	<b>0</b>	<b>27</b>	<b>1</b>	<b>63</b>
<b>Grand Total</b>	<b>14</b>	<b>40</b>	<b>5</b>	<b>0</b>	<b>51</b>	<b>1</b>	<b>111</b>
Apprch %	25.9	74.1	100	0	98.1	1.9	
Total %	12.6	36	4.5	0	45.9	0.9	

Start Time	South St From North			South St From South			Pleasant St From West			Int. Total
	Thru	Right	App. Total	Left	Thru	App. Total	Left	Right	App. Total	
Peak Hour Analysis From 07:00 AM to 08:45 AM - Peak 1 of 1										
Peak Hour for Entire Intersection Begins at 08:00 AM										
08:00 AM	0	7	7	1	0	1	5	1	6	14
08:15 AM	2	9	11	0	0	0	6	0	6	17
08:30 AM	1	3	4	0	0	0	9	0	9	13
08:45 AM	8	1	9	3	0	3	7	0	7	19
<b>Total Volume</b>	<b>11</b>	<b>20</b>	<b>31</b>	<b>4</b>	<b>0</b>	<b>4</b>	<b>27</b>	<b>1</b>	<b>28</b>	<b>63</b>
% App. Total	35.5	64.5		100	0		96.4	3.6		
PHF	.344	.556	.705	.333	.000	.333	.750	.250	.778	.829

# Accurate Counts

978-664-2565

N/S Street : South Street  
 E/W Street : Pleasant Street  
 City/State : Bridgewater, MA  
 Weather : Clear

File Name : 20270B10  
 Site Code : 20270010  
 Start Date : 10/2/2024  
 Page No : 8

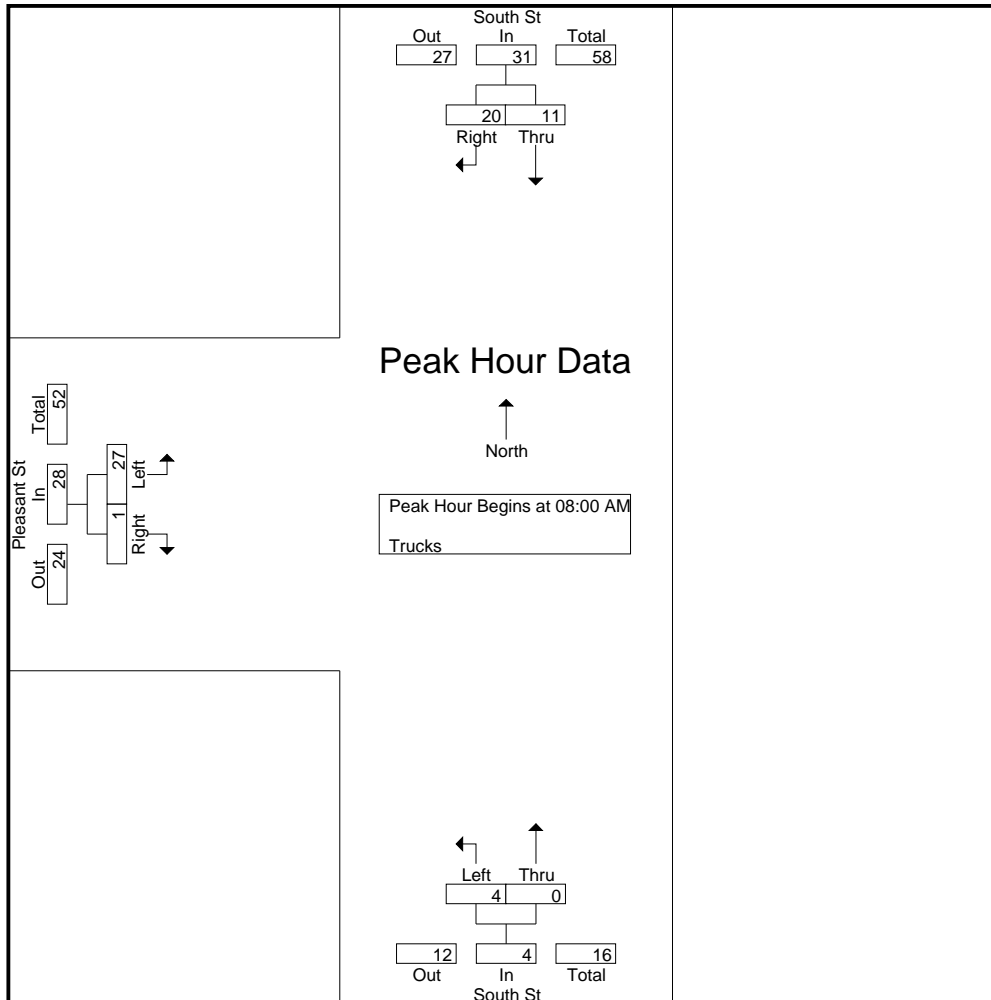

**Peak Hour Analysis From 07:00 AM to 08:45 AM - Peak 1 of 1**

Peak Hour for Each Approach Begins at:

	07:30 AM			08:00 AM			08:00 AM		
+0 mins.	3	3	6	1	0	1	5	1	6
+15 mins.	0	8	8	0	0	0	6	0	6
+30 mins.	0	7	7	0	0	0	9	0	9
+45 mins.	2	9	11	3	0	3	7	0	7
Total Volume	5	27	32	4	0	4	27	1	28
% App. Total	15.6	84.4		100	0		96.4	3.6	
PHF	.417	.750	.727	.333	.000	.333	.750	.250	.778



# Accurate Counts

978-664-2565

N/S Street : South Street  
E/W Street : Pleasant Street  
City/State : Bridgewater, MA  
Weather : Clear

File Name : 20270B10  
Site Code : 20270010  
Start Date : 10/2/2024  
Page No : 9

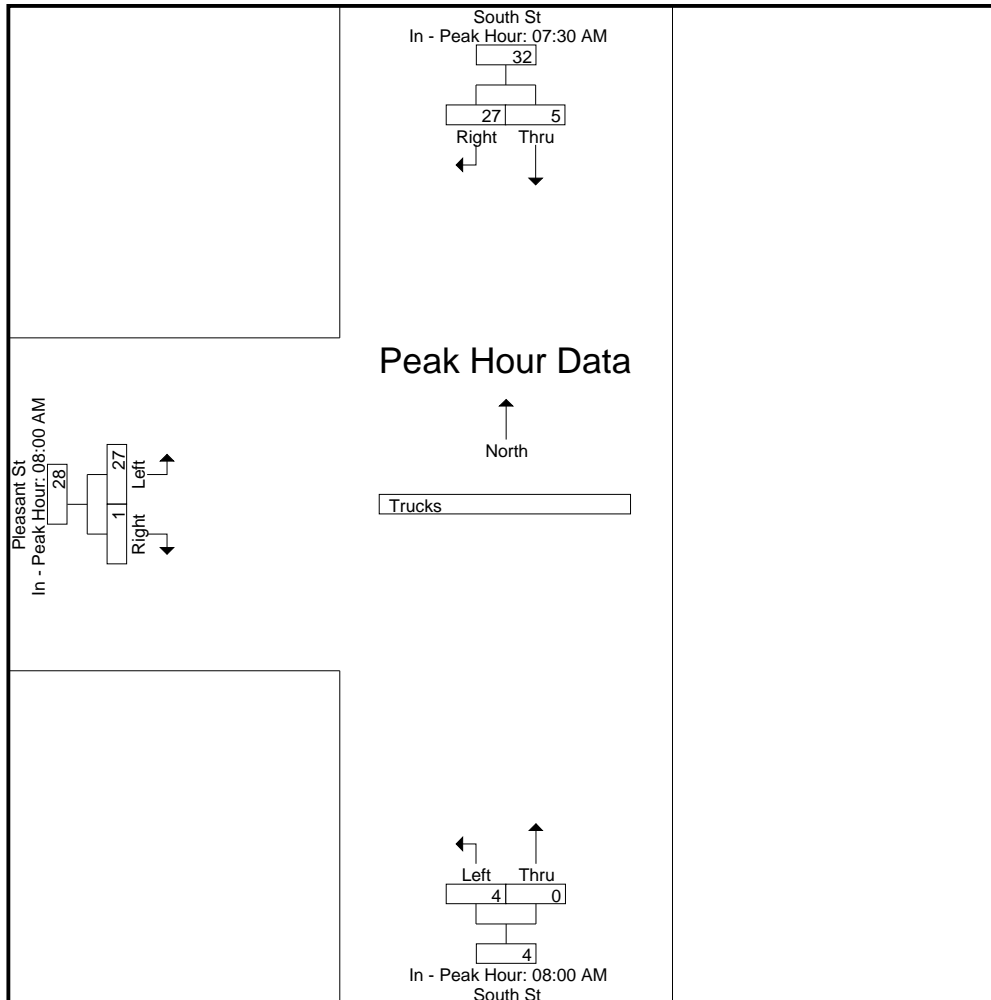

# Accurate Counts

978-664-2565

N/S Street : South Street  
 E/W Street : Pleasant Street  
 City/State : Bridgewater, MA  
 Weather : Clear

File Name : 20270B10  
 Site Code : 20270010  
 Start Date : 10/2/2024  
 Page No : 10

### Groups Printed- Bikes Peds

Start Time	South St From North			South St From South			Pleasant St From West			Exclu. Total	Inclu. Total	Int. Total
	Thru	Right	Peds	Left	Thru	Peds	Left	Right	Peds			
07:00 AM	0	0	0	0	0	0	0	0	0	0	0	0
07:15 AM	0	0	0	0	0	0	0	0	0	0	0	0
07:30 AM	0	0	0	0	0	0	0	0	0	0	0	0
07:45 AM	0	0	0	0	0	0	0	0	0	0	0	0
<b>Total</b>	<b>0</b>	<b>0</b>	<b>0</b>	<b>0</b>	<b>0</b>	<b>0</b>	<b>0</b>	<b>0</b>	<b>0</b>	<b>0</b>	<b>0</b>	<b>0</b>
08:00 AM	0	0	0	0	0	0	0	0	0	0	0	0
08:15 AM	0	0	0	0	0	0	0	0	0	0	0	0
08:30 AM	0	0	3	0	1	0	0	0	0	3	1	4
08:45 AM	1	0	1	0	0	0	0	0	0	1	1	2
<b>Total</b>	<b>1</b>	<b>0</b>	<b>4</b>	<b>0</b>	<b>1</b>	<b>0</b>	<b>0</b>	<b>0</b>	<b>0</b>	<b>4</b>	<b>2</b>	<b>6</b>
<b>Grand Total</b>	<b>1</b>	<b>0</b>	<b>4</b>	<b>0</b>	<b>1</b>	<b>0</b>	<b>0</b>	<b>0</b>	<b>0</b>	<b>4</b>	<b>2</b>	<b>6</b>
Apprch %	100	0		0	100		0	0				
Total %	50	0		0	50		0	0		66.7	33.3	

Start Time	South St From North			South St From South			Pleasant St From West			Int. Total
	Thru	Right	App. Total	Left	Thru	App. Total	Left	Right	App. Total	
Peak Hour Analysis From 07:00 AM to 08:45 AM - Peak 1 of 1										
Peak Hour for Entire Intersection Begins at 08:00 AM										
08:00 AM	0	0	0	0	0	0	0	0	0	0
08:15 AM	0	0	0	0	0	0	0	0	0	0
08:30 AM	0	0	0	0	1	1	0	0	0	1
08:45 AM	1	0	1	0	0	0	0	0	0	1
<b>Total Volume</b>	<b>1</b>	<b>0</b>	<b>1</b>	<b>0</b>	<b>1</b>	<b>1</b>	<b>0</b>	<b>0</b>	<b>0</b>	<b>2</b>
<b>% App. Total</b>	<b>100</b>	<b>0</b>		<b>0</b>	<b>100</b>		<b>0</b>	<b>0</b>		
<b>PHF</b>	<b>.250</b>	<b>.000</b>	<b>.250</b>	<b>.000</b>	<b>.250</b>	<b>.250</b>	<b>.000</b>	<b>.000</b>	<b>.000</b>	<b>.500</b>

# Accurate Counts

978-664-2565

N/S Street : South Street  
 E/W Street : Pleasant Street  
 City/State : Bridgewater, MA  
 Weather : Clear

File Name : 20270B10  
 Site Code : 20270010  
 Start Date : 10/2/2024  
 Page No : 11

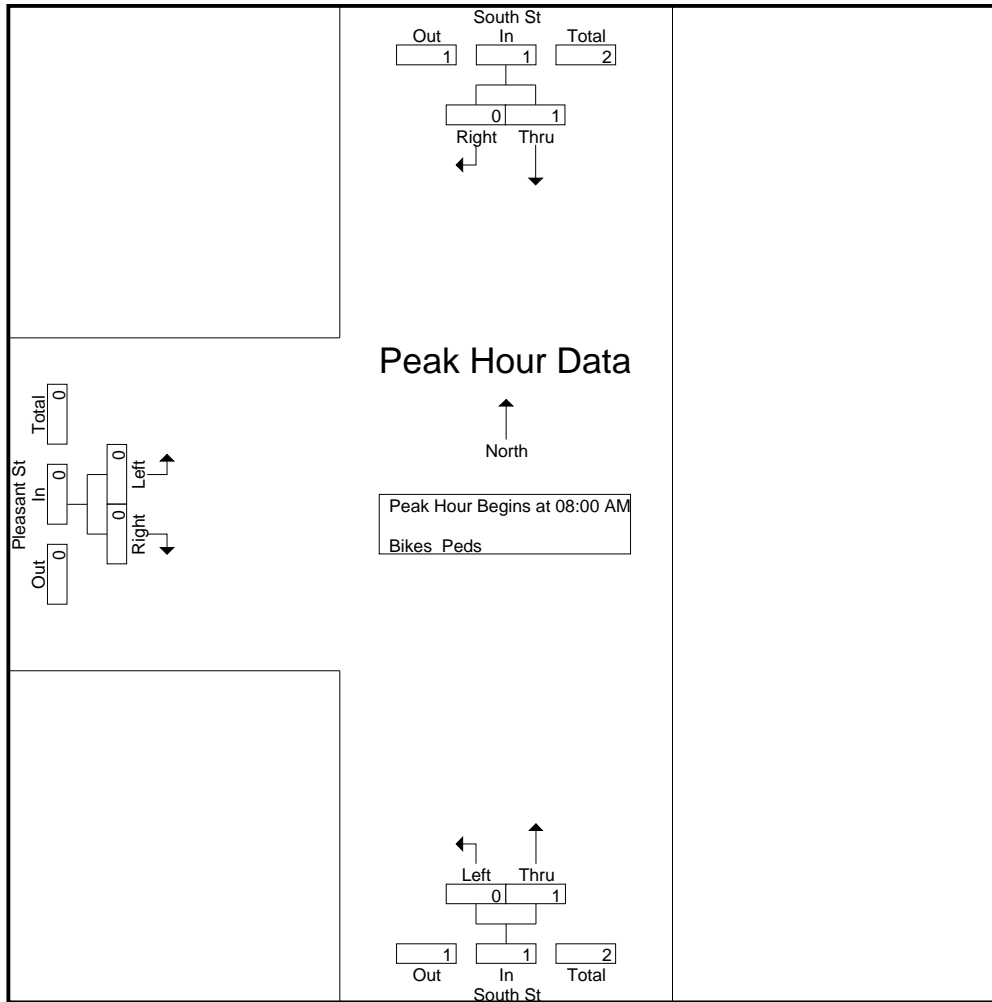

**Peak Hour Analysis From 07:00 AM to 08:45 AM - Peak 1 of 1**

Peak Hour for Each Approach Begins at:

	08:00 AM			07:45 AM			07:00 AM		
+0 mins.	0	0	0	0	0	0	0	0	0
+15 mins.	0	0	0	0	0	0	0	0	0
+30 mins.	0	0	0	0	0	0	0	0	0
+45 mins.	1	0	1	0	1	1	0	0	0
Total Volume	1	0	1	0	1	1	0	0	0
% App. Total	100	0		0	100		0	0	
PHF	.250	.000	.250	.000	.250	.250	.000	.000	.000

# Accurate Counts

978-664-2565

File Name : 20270B10

Site Code : 20270010

Start Date : 10/2/2024

Page No : 12

N/S Street : South Street  
E/W Street : Pleasant Street  
City/State : Bridgewater, MA  
Weather : Clear

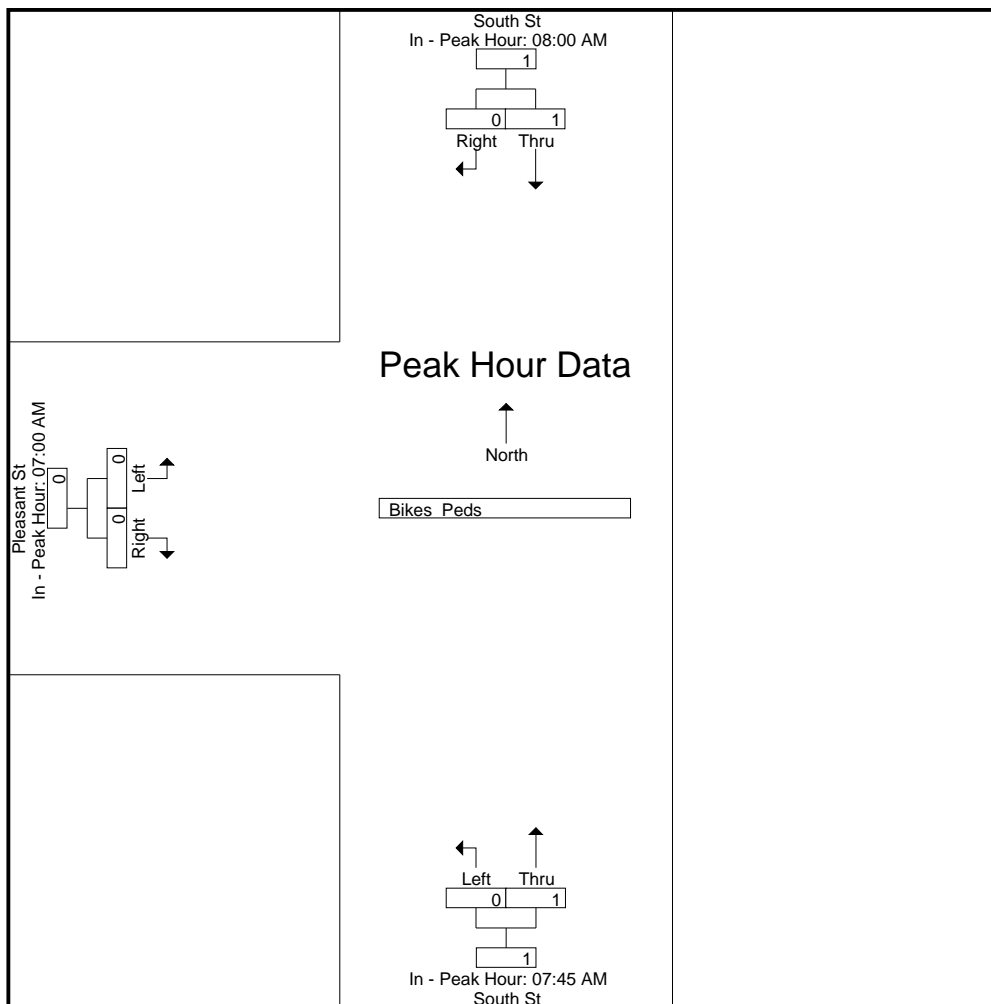

# Accurate Counts

978-664-2565

N/S Street : South Street  
 E/W Street : Pleasant Street  
 City/State : Bridgewater, MA  
 Weather : Clear

File Name : 20270B10  
 Site Code : 20270010  
 Start Date : 10/2/2024  
 Page No : 1

### Groups Printed- Cars - Trucks

Start Time	South St From North		South St From South		Pleasant St From West		Int. Total
	Thru	Right	Left	Thru	Left	Right	
04:00 PM	69	117	11	45	102	4	348
04:15 PM	56	96	7	48	106	7	320
04:30 PM	55	102	8	42	93	5	305
04:45 PM	52	99	7	49	97	11	315
<b>Total</b>	<b>232</b>	<b>414</b>	<b>33</b>	<b>184</b>	<b>398</b>	<b>27</b>	<b>1288</b>
05:00 PM	79	100	12	50	90	6	337
05:15 PM	67	111	10	61	100	17	366
05:30 PM	70	90	8	45	106	6	325
05:45 PM	52	91	8	47	110	14	322
<b>Total</b>	<b>268</b>	<b>392</b>	<b>38</b>	<b>203</b>	<b>406</b>	<b>43</b>	<b>1350</b>
<b>Grand Total</b>	<b>500</b>	<b>806</b>	<b>71</b>	<b>387</b>	<b>804</b>	<b>70</b>	<b>2638</b>
Apprch %	38.3	61.7	15.5	84.5	92	8	
Total %	19	30.6	2.7	14.7	30.5	2.7	
Cars	500	797	71	387	780	66	2601
% Cars	100	98.9	100	100	97	94.3	98.6
Trucks	0	9	0	0	24	4	37
% Trucks	0	1.1	0	0	3	5.7	1.4

Start Time	South St From North			South St From South			Pleasant St From West			Int. Total
	Thru	Right	App. Total	Left	Thru	App. Total	Left	Right	App. Total	
Peak Hour Analysis From 04:00 PM to 05:45 PM - Peak 1 of 1										
Peak Hour for Entire Intersection Begins at 05:00 PM										
05:00 PM	<b>79</b>	100	<b>179</b>	<b>12</b>	50	62	90	6	96	337
05:15 PM	67	<b>111</b>	178	10	<b>61</b>	<b>71</b>	100	<b>17</b>	117	<b>366</b>
05:30 PM	70	90	160	8	45	53	106	6	112	325
05:45 PM	52	91	143	8	47	55	<b>110</b>	14	<b>124</b>	322
<b>Total Volume</b>	<b>268</b>	<b>392</b>	<b>660</b>	<b>38</b>	<b>203</b>	<b>241</b>	<b>406</b>	<b>43</b>	<b>449</b>	<b>1350</b>
% App. Total	40.6	59.4		15.8	84.2		90.4	9.6		
PHF	.848	.883	.922	.792	.832	.849	.923	.632	.905	.922
Cars	268	391	659	38	203	241	398	41	439	1339
% Cars	100	99.7	99.8	100	100	100	98.0	95.3	97.8	99.2
Trucks	0	1	1	0	0	0	8	2	10	11
% Trucks	0	0.3	0.2	0	0	0	2.0	4.7	2.2	0.8

# Accurate Counts

978-664-2565

N/S Street : South Street  
 E/W Street : Pleasant Street  
 City/State : Bridgewater, MA  
 Weather : Clear

File Name : 20270B10  
 Site Code : 20270010  
 Start Date : 10/2/2024  
 Page No : 2

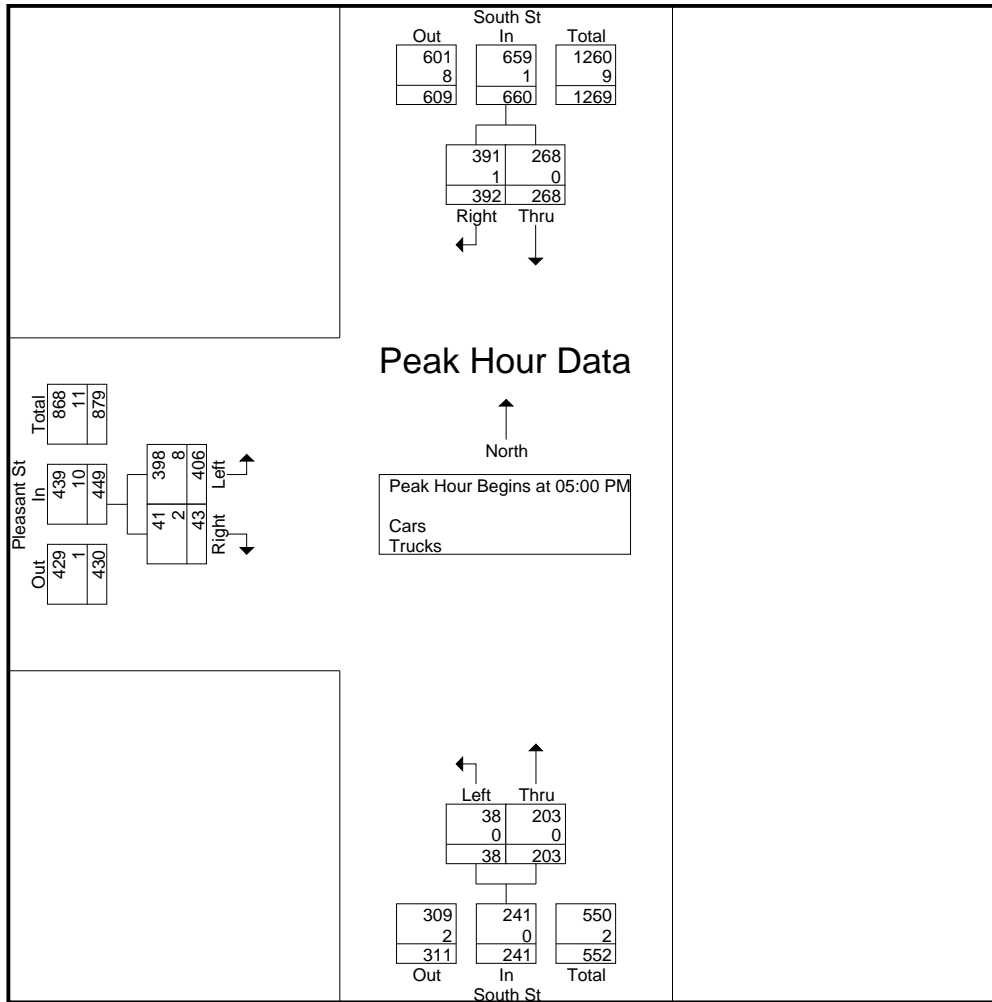

**Peak Hour Analysis From 04:00 PM to 05:45 PM - Peak 1 of 1**

Peak Hour for Each Approach Begins at:

	04:45 PM			04:45 PM			05:00 PM		
+0 mins.	52	99	151	7	49	56	90	6	96
+15 mins.	<b>79</b>	100	<b>179</b>	<b>12</b>	50	62	100	<b>17</b>	117
+30 mins.	67	<b>111</b>	178	10	<b>61</b>	<b>71</b>	106	6	112
+45 mins.	70	90	160	8	45	53	<b>110</b>	14	<b>124</b>
Total Volume	268	400	668	37	205	242	406	43	449
% App. Total	40.1	59.9		15.3	84.7		90.4	9.6	
PHF	.848	.901	.933	.771	.840	.852	.923	.632	.905
Cars	268	397	665	37	205	242	398	41	439
% Cars	100	99.2	99.6	100	100	100	98	95.3	97.8
Trucks	0	3	3	0	0	0	8	2	10
% Trucks	0	0.8	0.4	0	0	0	2	4.7	2.2

# Accurate Counts

978-664-2565

File Name : 20270B10

Site Code : 20270010

Start Date : 10/2/2024

Page No : 3

N/S Street : South Street  
 E/W Street : Pleasant Street  
 City/State : Bridgewater, MA  
 Weather : Clear

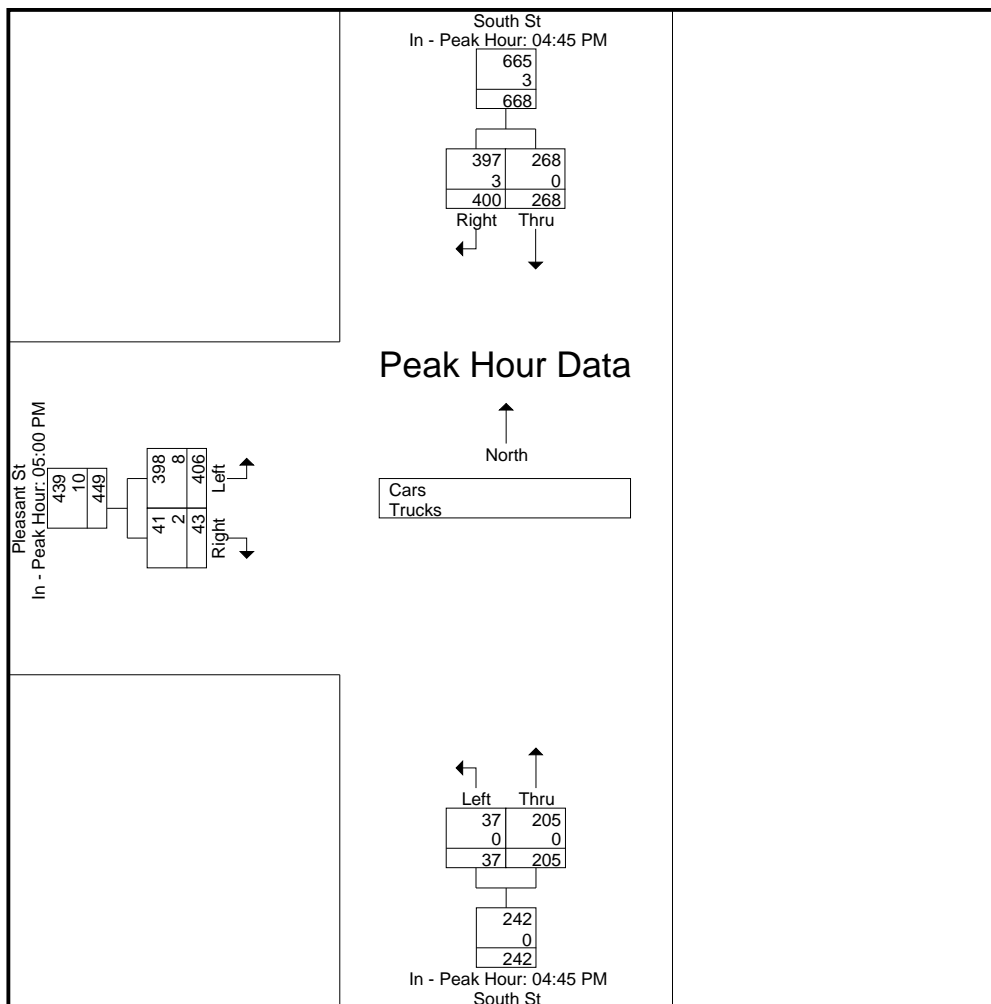

# Accurate Counts

978-664-2565

N/S Street : South Street  
 E/W Street : Pleasant Street  
 City/State : Bridgewater, MA  
 Weather : Clear

File Name : 20270B10  
 Site Code : 20270010  
 Start Date : 10/2/2024  
 Page No : 4

### Groups Printed- Cars

Start Time	South St From North		South St From South		Pleasant St From West		Int. Total
	Thru	Right	Left	Thru	Left	Right	
04:00 PM	69	114	11	45	99	4	342
04:15 PM	56	93	7	48	102	6	312
04:30 PM	55	102	8	42	89	4	300
04:45 PM	52	97	7	49	92	11	308
<b>Total</b>	<b>232</b>	<b>406</b>	<b>33</b>	<b>184</b>	<b>382</b>	<b>25</b>	<b>1262</b>
05:00 PM	79	99	12	50	87	6	333
05:15 PM	67	111	10	61	98	15	362
05:30 PM	70	90	8	45	104	6	323
05:45 PM	52	91	8	47	109	14	321
<b>Total</b>	<b>268</b>	<b>391</b>	<b>38</b>	<b>203</b>	<b>398</b>	<b>41</b>	<b>1339</b>
<b>Grand Total</b>	<b>500</b>	<b>797</b>	<b>71</b>	<b>387</b>	<b>780</b>	<b>66</b>	<b>2601</b>
Apprch %	38.6	61.4	15.5	84.5	92.2	7.8	
Total %	19.2	30.6	2.7	14.9	30	2.5	

Start Time	South St From North			South St From South			Pleasant St From West			Int. Total
	Thru	Right	App. Total	Left	Thru	App. Total	Left	Right	App. Total	
Peak Hour Analysis From 04:00 PM to 05:45 PM - Peak 1 of 1										
Peak Hour for Entire Intersection Begins at 05:00 PM										
05:00 PM	<b>79</b>	99	<b>178</b>	<b>12</b>	50	<b>62</b>	87	6	93	<b>333</b>
05:15 PM	67	<b>111</b>	178	10	<b>61</b>	<b>71</b>	98	<b>15</b>	113	<b>362</b>
05:30 PM	70	90	160	8	45	53	104	6	110	323
05:45 PM	52	91	143	8	47	55	<b>109</b>	14	<b>123</b>	321
<b>Total Volume</b>	<b>268</b>	<b>391</b>	<b>659</b>	<b>38</b>	<b>203</b>	<b>241</b>	<b>398</b>	<b>41</b>	<b>439</b>	<b>1339</b>
% App. Total	40.7	59.3		15.8	84.2		90.7	9.3		
PHF	.848	.881	.926	.792	.832	.849	.913	.683	.892	.925



# Accurate Counts

978-664-2565

N/S Street : South Street  
 E/W Street : Pleasant Street  
 City/State : Bridgewater, MA  
 Weather : Clear

File Name : 20270B10  
 Site Code : 20270010  
 Start Date : 10/2/2024  
 Page No : 5

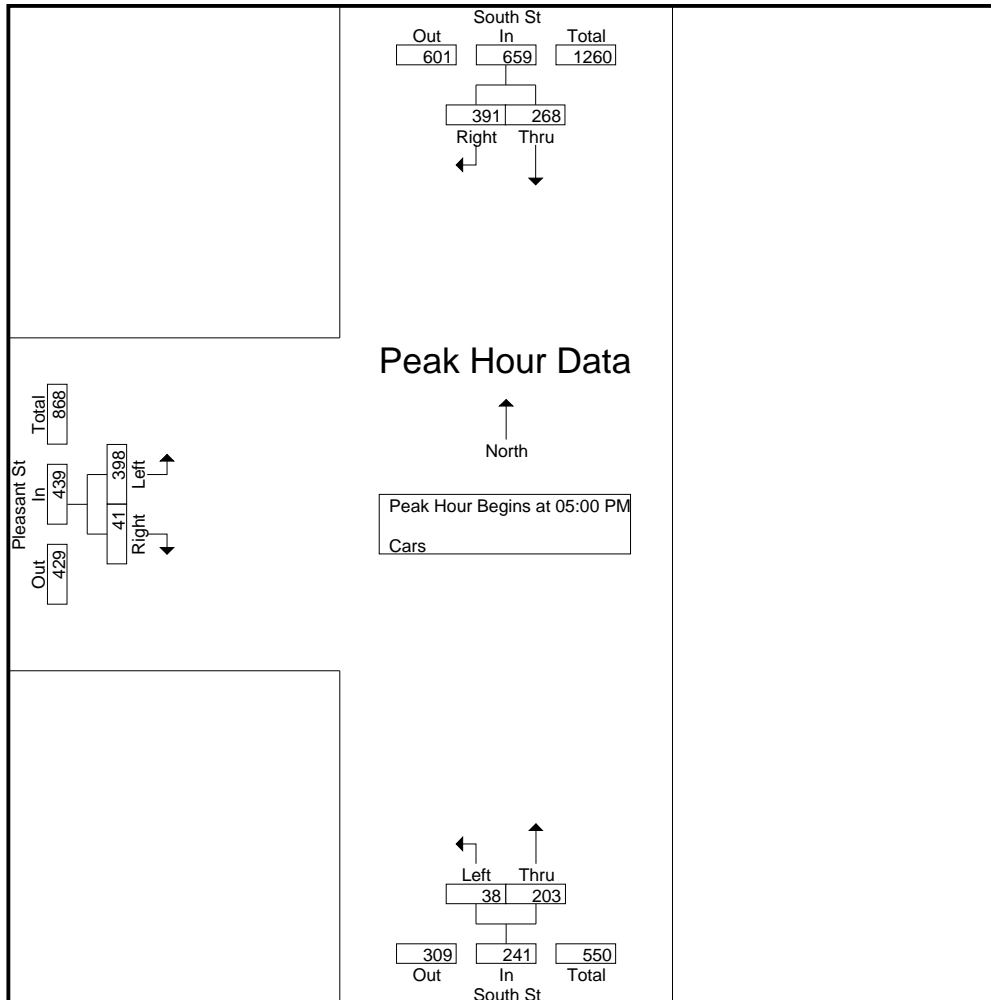

Peak Hour Analysis From 04:00 PM to 05:45 PM - Peak 1 of 1

Peak Hour for Each Approach Begins at:

	04:45 PM			04:45 PM			05:00 PM		
+0 mins.	52	97	149	7	49	56	87	6	93
+15 mins.	<b>79</b>	99	<b>178</b>	<b>12</b>	50	62	98	<b>15</b>	113
+30 mins.	67	<b>111</b>	178	10	<b>61</b>	<b>71</b>	104	6	110
+45 mins.	70	90	160	8	45	53	<b>109</b>	14	<b>123</b>
Total Volume	268	397	665	37	205	242	398	41	439
% App. Total	40.3	59.7		15.3	84.7		90.7	9.3	
PHF	.848	.894	.934	.771	.840	.852	.913	.683	.892

# Accurate Counts

978-664-2565

N/S Street : South Street  
E/W Street : Pleasant Street  
City/State : Bridgewater, MA  
Weather : Clear

File Name : 20270B10  
Site Code : 20270010  
Start Date : 10/2/2024  
Page No : 6

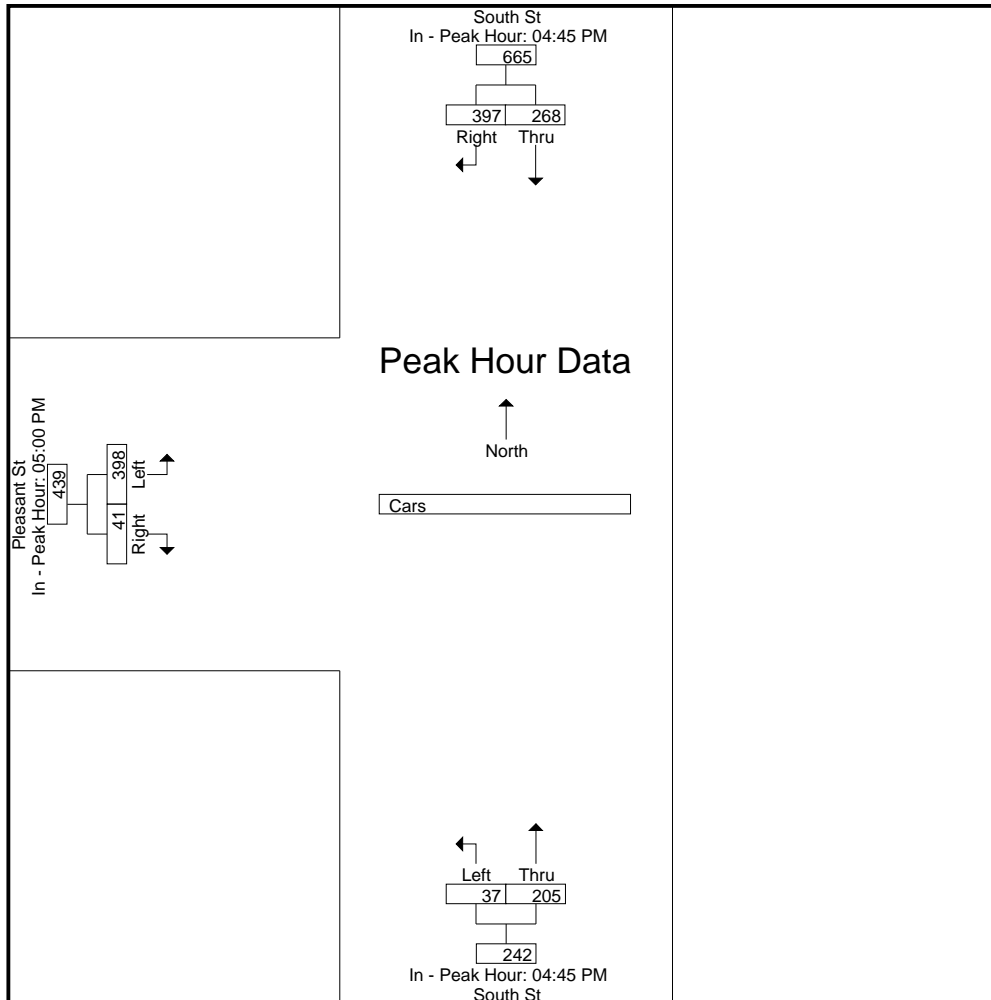

# Accurate Counts

978-664-2565

N/S Street : South Street  
 E/W Street : Pleasant Street  
 City/State : Bridgewater, MA  
 Weather : Clear

File Name : 20270B10  
 Site Code : 20270010  
 Start Date : 10/2/2024  
 Page No : 7

### Groups Printed- Trucks

Start Time	South St From North		South St From South		Pleasant St From West		Int. Total
	Thru	Right	Left	Thru	Left	Right	
04:00 PM	0	3	0	0	3	0	6
04:15 PM	0	3	0	0	4	1	8
04:30 PM	0	0	0	0	4	1	5
04:45 PM	0	2	0	0	5	0	7
<b>Total</b>	0	8	0	0	16	2	26
05:00 PM	0	1	0	0	3	0	4
05:15 PM	0	0	0	0	2	2	4
05:30 PM	0	0	0	0	2	0	2
05:45 PM	0	0	0	0	1	0	1
<b>Total</b>	0	1	0	0	8	2	11
<b>Grand Total</b>	0	9	0	0	24	4	37
Apprch %	0	100	0	0	85.7	14.3	
Total %	0	24.3	0	0	64.9	10.8	

Start Time	South St From North			South St From South			Pleasant St From West			Int. Total
	Thru	Right	App. Total	Left	Thru	App. Total	Left	Right	App. Total	
Peak Hour Analysis From 04:00 PM to 05:45 PM - Peak 1 of 1										
Peak Hour for Entire Intersection Begins at 04:00 PM										
04:00 PM	0	3	3	0	0	0	3	0	3	6
04:15 PM	0	3	3	0	0	0	4	1	5	8
04:30 PM	0	0	0	0	0	0	4	1	5	5
04:45 PM	0	2	2	0	0	0	5	0	5	7
<b>Total Volume</b>	0	8	8	0	0	0	16	2	18	26
<b>% App. Total</b>	0	100		0	0		88.9	11.1		
<b>PHF</b>	.000	.667	.667	.000	.000	.000	.800	.500	.900	.813

# Accurate Counts

978-664-2565

N/S Street : South Street  
 E/W Street : Pleasant Street  
 City/State : Bridgewater, MA  
 Weather : Clear

File Name : 20270B10  
 Site Code : 20270010  
 Start Date : 10/2/2024  
 Page No : 8

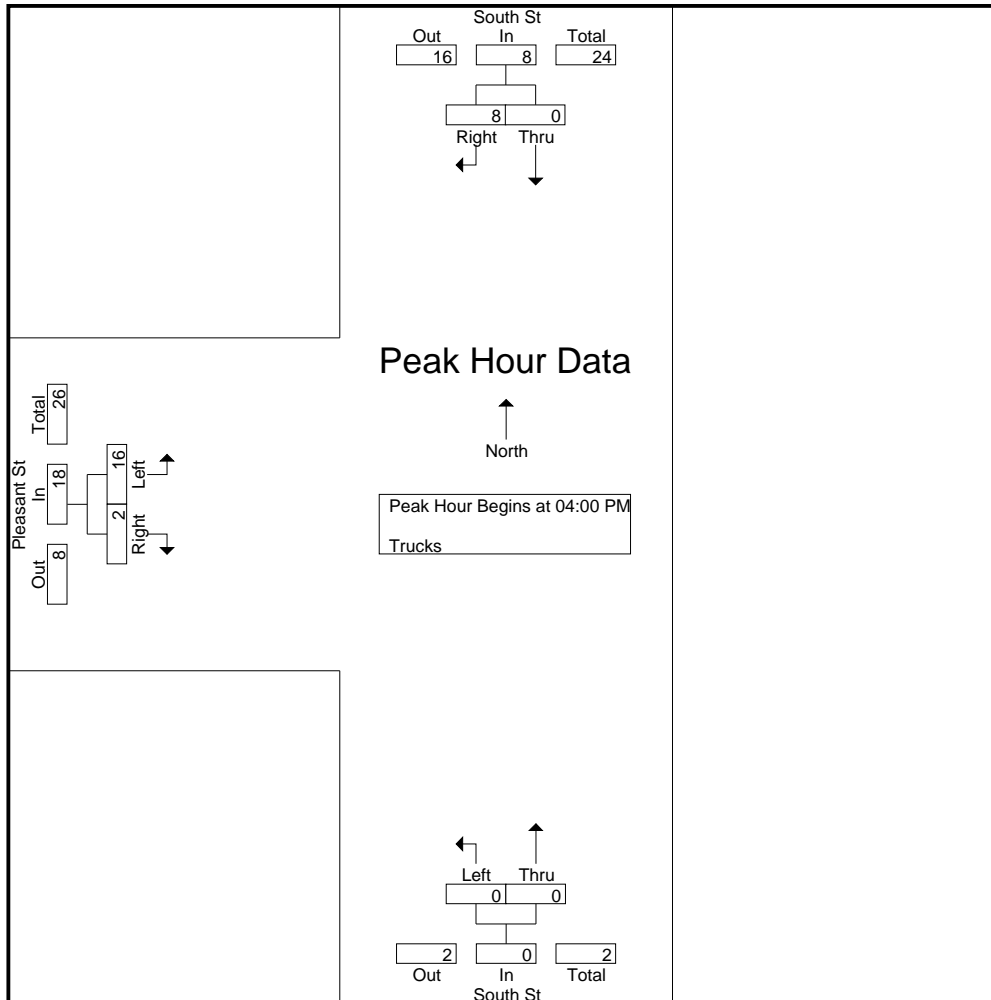

Peak Hour Analysis From 04:00 PM to 05:45 PM - Peak 1 of 1

Peak Hour for Each Approach Begins at:

	04:00 PM			04:00 PM			04:00 PM		
+0 mins.	0	3	3	0	0	0	3	0	3
+15 mins.	0	3	3	0	0	0	4	1	5
+30 mins.	0	0	0	0	0	0	4	1	5
+45 mins.	0	2	2	0	0	0	5	0	5
Total Volume	0	8	8	0	0	0	16	2	18
% App. Total	0	100		0	0		88.9	11.1	
PHF	.000	.667	.667	.000	.000	.000	.800	.500	.900

# Accurate Counts

978-664-2565

N/S Street : South Street  
E/W Street : Pleasant Street  
City/State : Bridgewater, MA  
Weather : Clear

File Name : 20270B10  
Site Code : 20270010  
Start Date : 10/2/2024  
Page No : 9

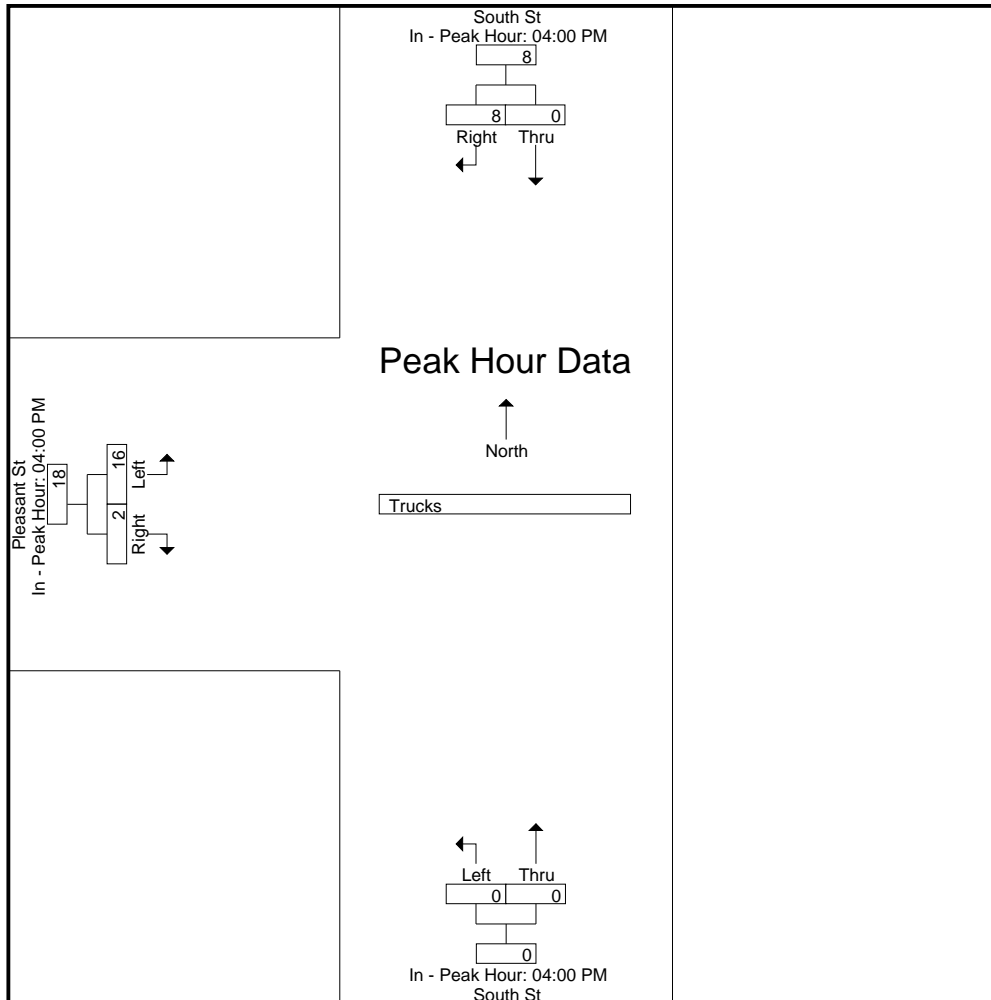

# Accurate Counts

978-664-2565

N/S Street : South Street  
 E/W Street : Pleasant Street  
 City/State : Bridgewater, MA  
 Weather : Clear

File Name : 20270B10  
 Site Code : 20270010  
 Start Date : 10/2/2024  
 Page No : 10

### Groups Printed- Bikes Peds

Start Time	South St From North			South St From South			Pleasant St From West			Exclu. Total	Inclu. Total	Int. Total
	Thru	Right	Peds	Left	Thru	Peds	Left	Right	Peds			
04:00 PM	0	0	0	0	0	0	0	0	0	0	0	0
04:15 PM	0	0	0	0	0	0	0	0	0	0	0	0
04:30 PM	0	0	0	0	0	0	1	0	0	0	1	1
04:45 PM	0	0	0	0	0	0	0	0	0	0	0	0
<b>Total</b>	<b>0</b>	<b>0</b>	<b>0</b>	<b>0</b>	<b>0</b>	<b>0</b>	<b>1</b>	<b>0</b>	<b>0</b>	<b>0</b>	<b>1</b>	<b>1</b>
05:00 PM	0	0	0	0	0	0	0	0	0	0	0	0
05:15 PM	1	0	0	0	0	0	0	0	1	1	1	2
05:30 PM	0	0	0	0	0	0	0	0	0	0	0	0
05:45 PM	0	0	0	0	0	1	0	0	0	1	0	1
<b>Total</b>	<b>1</b>	<b>0</b>	<b>0</b>	<b>0</b>	<b>0</b>	<b>1</b>	<b>0</b>	<b>0</b>	<b>1</b>	<b>2</b>	<b>1</b>	<b>3</b>
<b>Grand Total</b>	<b>1</b>	<b>0</b>	<b>0</b>	<b>0</b>	<b>0</b>	<b>1</b>	<b>1</b>	<b>0</b>	<b>1</b>	<b>2</b>	<b>2</b>	<b>4</b>
Apprch %	100	0		0	0		100	0				
Total %	50	0		0	0		50	0		50	50	

Start Time	South St From North			South St From South			Pleasant St From West			Int. Total
	Thru	Right	App. Total	Left	Thru	App. Total	Left	Right	App. Total	
Peak Hour Analysis From 04:00 PM to 05:45 PM - Peak 1 of 1										
Peak Hour for Entire Intersection Begins at 04:30 PM										
04:30 PM	0	0	0	0	0	0	1	0	1	1
04:45 PM	0	0	0	0	0	0	0	0	0	0
05:00 PM	0	0	0	0	0	0	0	0	0	0
05:15 PM	1	0	1	0	0	0	0	0	0	1
<b>Total Volume</b>	<b>1</b>	<b>0</b>	<b>1</b>	<b>0</b>	<b>0</b>	<b>0</b>	<b>1</b>	<b>0</b>	<b>1</b>	<b>2</b>
<b>% App. Total</b>	<b>100</b>	<b>0</b>		<b>0</b>	<b>0</b>		<b>100</b>	<b>0</b>		
<b>PHF</b>	<b>.250</b>	<b>.000</b>	<b>.250</b>	<b>.000</b>	<b>.000</b>	<b>.000</b>	<b>.250</b>	<b>.000</b>	<b>.250</b>	<b>.500</b>

# Accurate Counts

978-664-2565

N/S Street : South Street  
 E/W Street : Pleasant Street  
 City/State : Bridgewater, MA  
 Weather : Clear

File Name : 20270B10  
 Site Code : 20270010  
 Start Date : 10/2/2024  
 Page No : 11

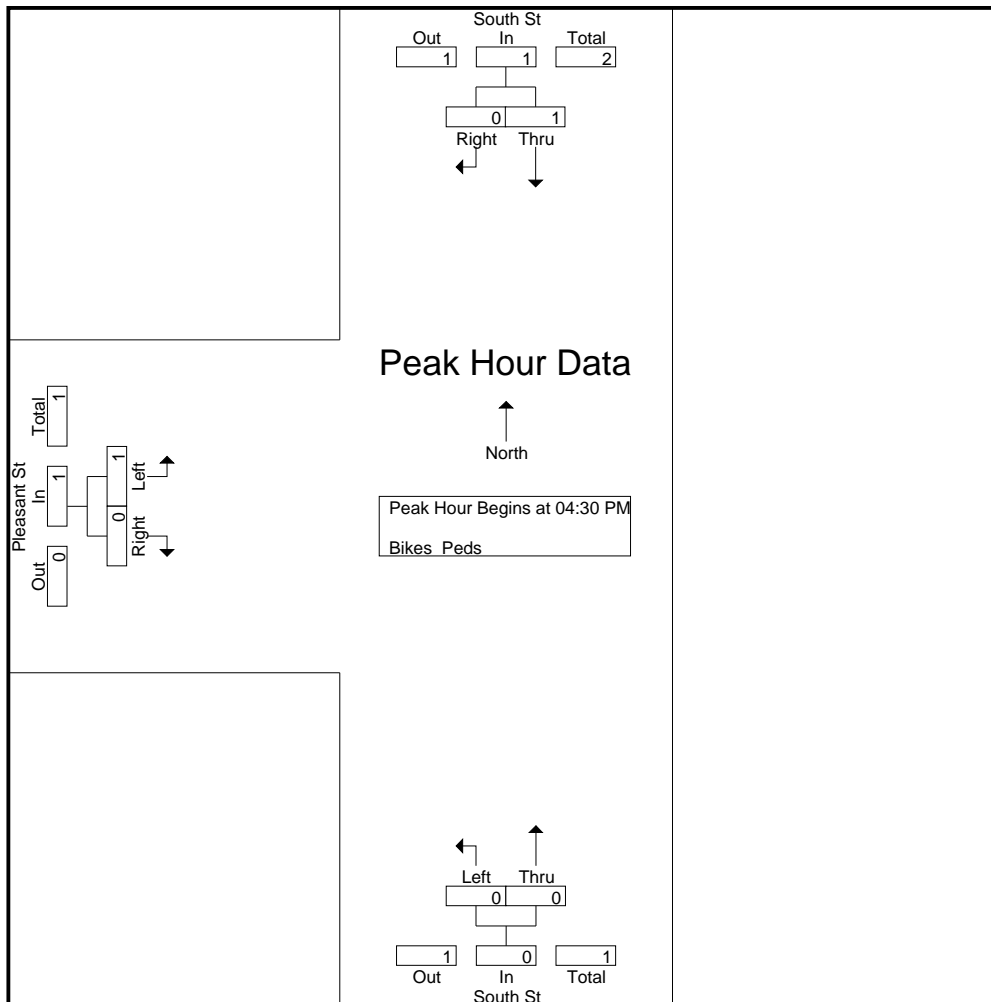

Peak Hour Analysis From 04:00 PM to 05:45 PM - Peak 1 of 1

Peak Hour for Each Approach Begins at:

	04:30 PM			04:00 PM			04:00 PM		
+0 mins.	0	0	0	0	0	0	0	0	0
+15 mins.	0	0	0	0	0	0	0	0	0
+30 mins.	0	0	0	0	0	0	1	0	1
+45 mins.	1	0	1	0	0	0	0	0	0
Total Volume	1	0	1	0	0	0	1	0	1
% App. Total	100	0		0	0		100	0	
PHF	.250	.000	.250	.000	.000	.000	.250	.000	.250

# Accurate Counts

978-664-2565

File Name : 20270B10

Site Code : 20270010

Start Date : 10/2/2024

Page No : 12

N/S Street : South Street  
E/W Street : Pleasant Street  
City/State : Bridgewater, MA  
Weather : Clear

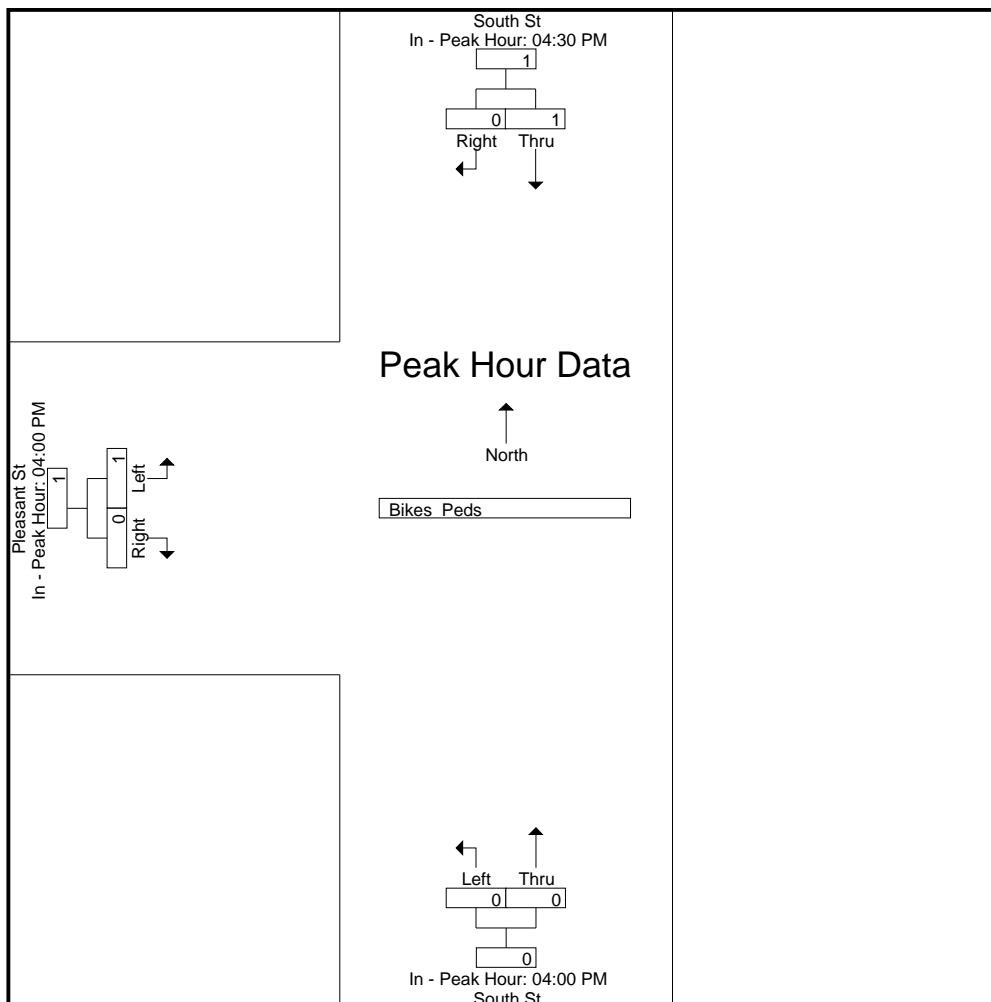



# Accurate Counts

978-664-2565

N/S Street : South Street  
 E/W Street : School St / Church Driveway  
 City/State : Bridgewater, MA  
 Weather : Clear

File Name : 20270B11  
 Site Code : 20270011  
 Start Date : 10/2/2024  
 Page No : 1

### Groups Printed- Cars - Trucks

Start Time	South St From North			School St From East			South St From South			Church Driveway From West			Int. Total
	Left	Thru	Right	Left	Thru	Right	Left	Thru	Right	Left	Thru	Right	
07:00 AM	89	125	0	0	0	0	0	0	100	0	2	0	316
07:15 AM	106	122	2	0	0	0	0	0	121	0	3	0	354
07:30 AM	115	127	0	0	0	0	0	0	146	0	6	0	394
07:45 AM	123	134	1	0	0	0	0	0	135	0	5	0	398
<b>Total</b>	<b>433</b>	<b>508</b>	<b>3</b>	<b>0</b>	<b>0</b>	<b>0</b>	<b>0</b>	<b>0</b>	<b>502</b>	<b>0</b>	<b>16</b>	<b>0</b>	<b>1462</b>
08:00 AM	128	136	0	0	0	0	0	0	104	0	4	0	372
08:15 AM	125	114	0	0	0	0	0	0	121	0	10	0	370
08:30 AM	109	103	3	0	0	0	0	0	131	0	6	1	353
08:45 AM	147	113	0	0	0	0	0	0	121	0	10	4	395
<b>Total</b>	<b>509</b>	<b>466</b>	<b>3</b>	<b>0</b>	<b>0</b>	<b>0</b>	<b>0</b>	<b>0</b>	<b>477</b>	<b>0</b>	<b>30</b>	<b>5</b>	<b>1490</b>
<b>Grand Total</b>	<b>942</b>	<b>974</b>	<b>6</b>	<b>0</b>	<b>0</b>	<b>0</b>	<b>0</b>	<b>0</b>	<b>979</b>	<b>0</b>	<b>46</b>	<b>5</b>	<b>2952</b>
Apprch %	49	50.7	0.3	0	0	0	0	0	100	0	90.2	9.8	
Total %	31.9	33	0.2	0	0	0	0	0	33.2	0	1.6	0.2	
Cars	903	908	6	0	0	0	0	0	917	0	35	5	2774
% Cars	95.9	93.2	100	0	0	0	0	0	93.7	0	76.1	100	94
Trucks	39	66	0	0	0	0	0	0	62	0	11	0	178
% Trucks	4.1	6.8	0	0	0	0	0	0	6.3	0	23.9	0	6

Start Time	South St From North				School St From East				South St From South				Church Driveway From West				Int. Total
	Left	Thru	Right	App. Total	Left	Thru	Right	App. Total	Left	Thru	Right	App. Total	Left	Thru	Right	App. Total	
Peak Hour Analysis From 07:00 AM to 08:45 AM - Peak 1 of 1																	
Peak Hour for Entire Intersection Begins at 07:30 AM																	
07:30 AM	115	127	0	242	0	0	0	0	0	0	<b>146</b>	<b>146</b>	0	6	0	6	394
07:45 AM	123	134	1	258	0	0	0	0	0	0	135	135	0	5	0	5	<b>398</b>
08:00 AM	<b>128</b>	<b>136</b>	0	<b>264</b>	0	0	0	0	0	0	104	104	0	4	0	4	372
08:15 AM	125	114	0	239	0	0	0	0	0	0	121	121	0	<b>10</b>	0	<b>10</b>	370
<b>Total Volume</b>	<b>491</b>	<b>511</b>	<b>1</b>	<b>1003</b>	<b>0</b>	<b>0</b>	<b>0</b>	<b>0</b>	<b>0</b>	<b>0</b>	<b>506</b>	<b>506</b>	<b>0</b>	<b>25</b>	<b>0</b>	<b>25</b>	<b>1534</b>
% App. Total	49	50.9	0.1		0	0	0		0	0	100		0	100	0		
PHF	.959	.939	.250	.950	.000	.000	.000	.000	.000	.000	.866	.866	.000	.625	.000	.625	.964
Cars	473	473	1	947	0	0	0	0	0	0	476	476	0	16	0	16	1439
% Cars	96.3	92.6	100	94.4	0	0	0	0	0	0	94.1	94.1	0	64.0	0	64.0	93.8
Trucks	18	38	0	56	0	0	0	0	0	0	30	30	0	9	0	9	95
% Trucks	3.7	7.4	0	5.6	0	0	0	0	0	0	5.9	5.9	0	36.0	0	36.0	6.2

# Accurate Counts

978-664-2565

N/S Street : South Street  
 E/W Street : School St / Church Driveway  
 City/State : Bridgewater, MA  
 Weather : Clear

File Name : 20270B11  
 Site Code : 20270011  
 Start Date : 10/2/2024  
 Page No : 2

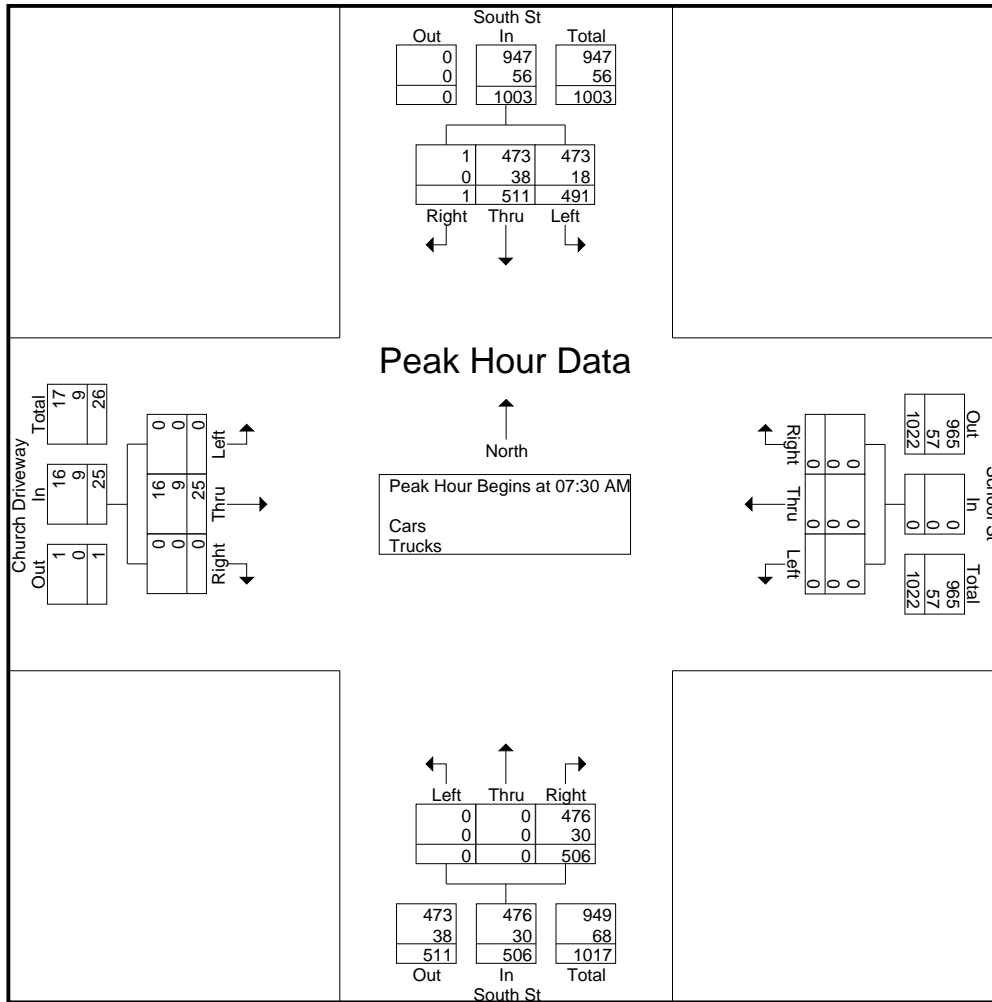

**Peak Hour Analysis From 07:00 AM to 08:45 AM - Peak 1 of 1**

**Peak Hour for Each Approach Begins at:**

	07:30 AM				07:00 AM				07:15 AM				08:00 AM			
+0 mins.	115	127	0	242	0	0	0	0	0	0	121	121	0	4	0	4
+15 mins.	123	134	1	258	0	0	0	0	0	0	<b>146</b>	<b>146</b>	0	<b>10</b>	0	10
+30 mins.	<b>128</b>	<b>136</b>	0	<b>264</b>	0	0	0	0	0	0	135	135	0	6	1	7
+45 mins.	125	114	0	239	0	0	0	0	0	0	104	104	0	10	<b>4</b>	<b>14</b>
Total Volume	491	511	1	1003	0	0	0	0	0	0	506	506	0	30	5	35
% App. Total	49	50.9	0.1		0	0	0		0	0	100		0	85.7	14.3	
PHF	.959	.939	.250	.950	.000	.000	.000	.000	.000	.000	.866	.866	.000	.750	.313	.625
Cars	473	473	1	947	0	0	0	0	0	0	479	479	0	24	5	29
% Cars	96.3	92.6	100	94.4	0	0	0	0	0	0	94.7	94.7	0	80	100	82.9
Trucks	18	38	0	56	0	0	0	0	0	0	27	27	0	6	0	6
% Trucks	3.7	7.4	0	5.6	0	0	0	0	0	0	5.3	5.3	0	20	0	17.1

# Accurate Counts

978-664-2565

File Name : 20270B11

Site Code : 20270011

Start Date : 10/2/2024

Page No : 3

N/S Street : South Street  
 E/W Street : School St / Church Driveway  
 City/State : Bridgewater, MA  
 Weather : Clear

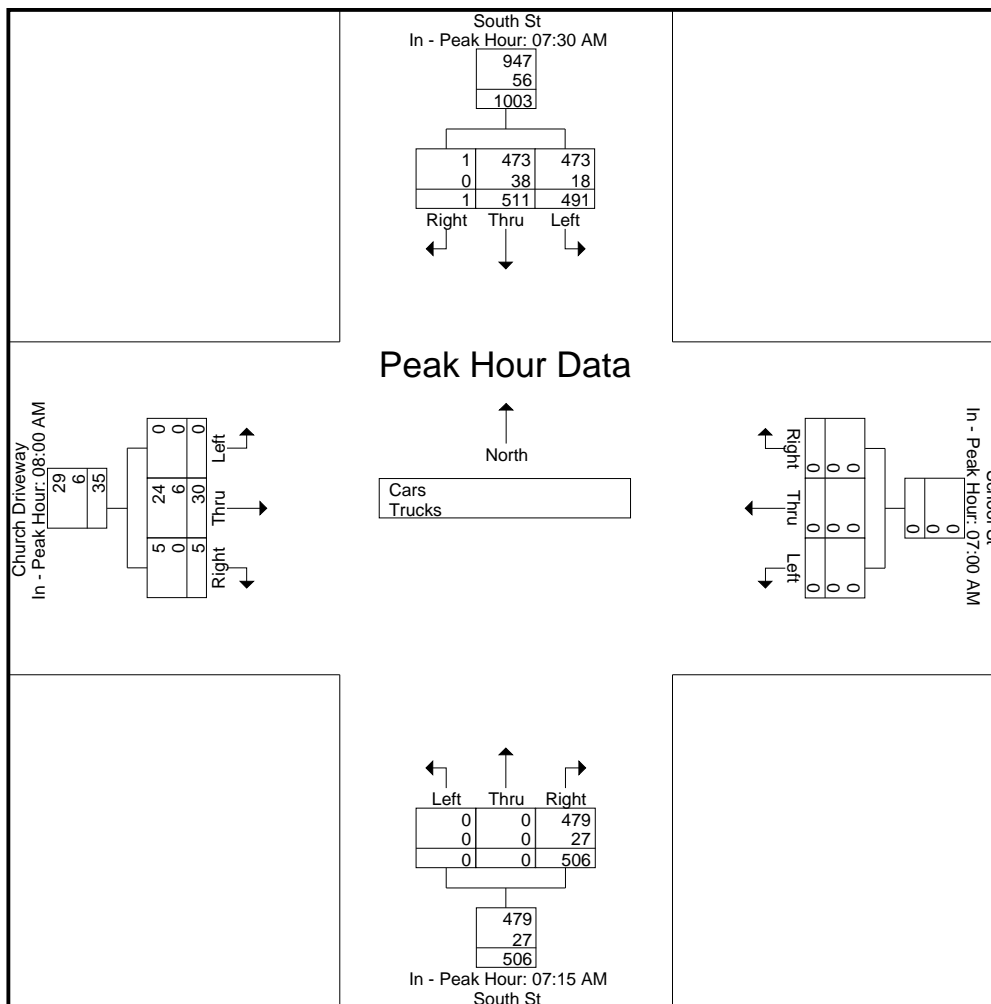

# Accurate Counts

978-664-2565

N/S Street : South Street  
 E/W Street : School St / Church Driveway  
 City/State : Bridgewater, MA  
 Weather : Clear

File Name : 20270B11  
 Site Code : 20270011  
 Start Date : 10/2/2024  
 Page No : 4

## Groups Printed- Cars

Start Time	South St From North			School St From East			South St From South			Church Driveway From West			Int. Total
	Left	Thru	Right	Left	Thru	Right	Left	Thru	Right	Left	Thru	Right	
07:00 AM	88	116	0	0	0	0	0	0	91	0	2	0	297
07:15 AM	100	120	2	0	0	0	0	0	117	0	2	0	341
07:30 AM	110	118	0	0	0	0	0	0	133	0	4	0	365
07:45 AM	119	124	1	0	0	0	0	0	129	0	3	0	376
<b>Total</b>	<b>417</b>	<b>478</b>	<b>3</b>	<b>0</b>	<b>0</b>	<b>0</b>	<b>0</b>	<b>0</b>	<b>470</b>	<b>0</b>	<b>11</b>	<b>0</b>	<b>1379</b>
08:00 AM	124	126	0	0	0	0	0	0	100	0	4	0	354
08:15 AM	120	105	0	0	0	0	0	0	114	0	5	0	344
08:30 AM	102	95	3	0	0	0	0	0	117	0	5	1	323
08:45 AM	140	104	0	0	0	0	0	0	116	0	10	4	374
<b>Total</b>	<b>486</b>	<b>430</b>	<b>3</b>	<b>0</b>	<b>0</b>	<b>0</b>	<b>0</b>	<b>0</b>	<b>447</b>	<b>0</b>	<b>24</b>	<b>5</b>	<b>1395</b>
<b>Grand Total</b>	<b>903</b>	<b>908</b>	<b>6</b>	<b>0</b>	<b>0</b>	<b>0</b>	<b>0</b>	<b>0</b>	<b>917</b>	<b>0</b>	<b>35</b>	<b>5</b>	<b>2774</b>
Apprch %	49.7	50	0.3	0	0	0	0	0	100	0	87.5	12.5	
Total %	32.6	32.7	0.2	0	0	0	0	0	33.1	0	1.3	0.2	

Start Time	South St From North				School St From East				South St From South				Church Driveway From West				Int. Total
	Left	Thru	Right	App. Total	Left	Thru	Right	App. Total	Left	Thru	Right	App. Total	Left	Thru	Right	App. Total	
<b>Peak Hour Analysis From 07:00 AM to 08:45 AM - Peak 1 of 1</b>																	
<b>Peak Hour for Entire Intersection Begins at 07:30 AM</b>																	
07:30 AM	110	118	0	228	0	0	0	0	0	0	133	133	0	4	0	4	365
07:45 AM	119	124	1	244	0	0	0	0	0	0	129	129	0	3	0	3	376
08:00 AM	124	126	0	250	0	0	0	0	0	0	100	100	0	4	0	4	354
08:15 AM	120	105	0	225	0	0	0	0	0	0	114	114	0	5	0	5	344
<b>Total Volume</b>	<b>473</b>	<b>473</b>	<b>1</b>	<b>947</b>	<b>0</b>	<b>0</b>	<b>0</b>	<b>0</b>	<b>0</b>	<b>0</b>	<b>476</b>	<b>476</b>	<b>0</b>	<b>16</b>	<b>0</b>	<b>16</b>	<b>1439</b>
<b>% App. Total</b>	<b>49.9</b>	<b>49.9</b>	<b>0.1</b>		<b>0</b>	<b>0</b>	<b>0</b>		<b>0</b>	<b>0</b>	<b>100</b>		<b>0</b>	<b>100</b>	<b>0</b>		
PHF	.954	.938	.250	.947	.000	.000	.000	.000	.000	.000	.895	.895	.000	.800	.000	.800	.957

# Accurate Counts

978-664-2565

N/S Street : South Street  
 E/W Street : School St / Church Driveway  
 City/State : Bridgewater, MA  
 Weather : Clear

File Name : 20270B11  
 Site Code : 20270011  
 Start Date : 10/2/2024  
 Page No : 5

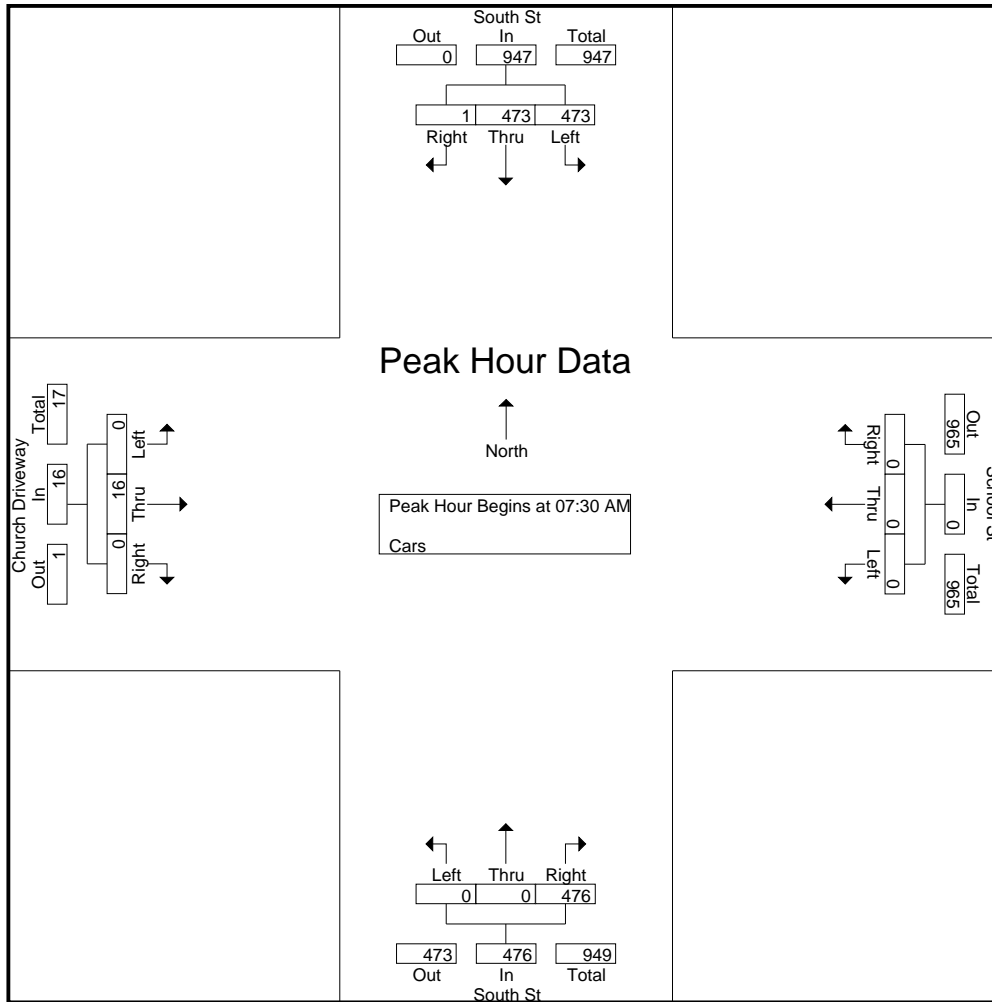

**Peak Hour Analysis From 07:00 AM to 08:45 AM - Peak 1 of 1**

Peak Hour for Each Approach Begins at:

	07:30 AM				07:00 AM				07:15 AM				08:00 AM			
+0 mins.	110	118	0	228	0	0	0	0	0	0	117	117	0	4	0	4
+15 mins.	119	124	1	244	0	0	0	0	0	0	<b>133</b>	<b>133</b>	0	5	0	5
+30 mins.	<b>124</b>	<b>126</b>	0	<b>250</b>	0	0	0	0	0	0	129	129	0	5	1	6
+45 mins.	120	105	0	225	0	0	0	0	0	0	100	100	0	<b>10</b>	<b>4</b>	<b>14</b>
Total Volume	473	473	1	947	0	0	0	0	0	0	479	479	0	24	5	29
% App. Total	49.9	49.9	0.1		0	0	0		0	0	100		0	82.8	17.2	
PHF	.954	.938	.250	.947	.000	.000	.000	.000	.000	.000	.900	.900	.000	.600	.313	.518

# Accurate Counts

978-664-2565

File Name : 20270B11

Site Code : 20270011

Start Date : 10/2/2024

Page No : 6

N/S Street : South Street  
 E/W Street : School St / Church Driveway  
 City/State : Bridgewater, MA  
 Weather : Clear

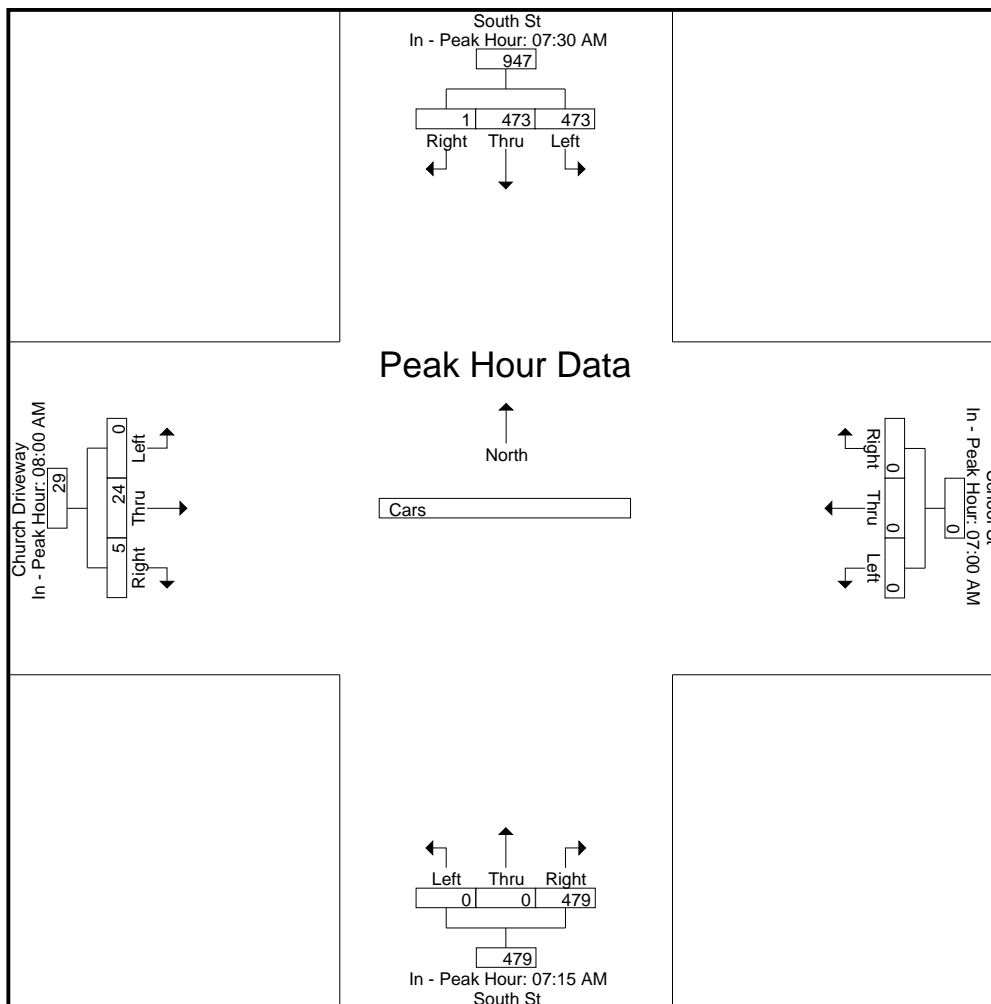

# Accurate Counts

978-664-2565

N/S Street : South Street  
 E/W Street : School St / Church Driveway  
 City/State : Bridgewater, MA  
 Weather : Clear

File Name : 20270B11  
 Site Code : 20270011  
 Start Date : 10/2/2024  
 Page No : 7

### Groups Printed- Trucks

Start Time	South St From North			School St From East			South St From South			Church Driveway From West			Int. Total
	Left	Thru	Right	Left	Thru	Right	Left	Thru	Right	Left	Thru	Right	
07:00 AM	1	9	0	0	0	0	0	0	9	0	0	0	19
07:15 AM	6	2	0	0	0	0	0	0	4	0	1	0	13
07:30 AM	5	9	0	0	0	0	0	0	13	0	2	0	29
07:45 AM	4	10	0	0	0	0	0	0	6	0	2	0	22
<b>Total</b>	<b>16</b>	<b>30</b>	<b>0</b>	<b>0</b>	<b>0</b>	<b>0</b>	<b>0</b>	<b>0</b>	<b>32</b>	<b>0</b>	<b>5</b>	<b>0</b>	<b>83</b>
08:00 AM	4	10	0	0	0	0	0	0	4	0	0	0	18
08:15 AM	5	9	0	0	0	0	0	0	7	0	5	0	26
08:30 AM	7	8	0	0	0	0	0	0	14	0	1	0	30
08:45 AM	7	9	0	0	0	0	0	0	5	0	0	0	21
<b>Total</b>	<b>23</b>	<b>36</b>	<b>0</b>	<b>0</b>	<b>0</b>	<b>0</b>	<b>0</b>	<b>0</b>	<b>30</b>	<b>0</b>	<b>6</b>	<b>0</b>	<b>95</b>
<b>Grand Total</b>	<b>39</b>	<b>66</b>	<b>0</b>	<b>0</b>	<b>0</b>	<b>0</b>	<b>0</b>	<b>0</b>	<b>62</b>	<b>0</b>	<b>11</b>	<b>0</b>	<b>178</b>
Apprch %	37.1	62.9	0	0	0	0	0	0	100	0	100	0	
Total %	21.9	37.1	0	0	0	0	0	0	34.8	0	6.2	0	

Start Time	South St From North				School St From East				South St From South				Church Driveway From West				Int. Total
	Left	Thru	Right	App. Total	Left	Thru	Right	App. Total	Left	Thru	Right	App. Total	Left	Thru	Right	App. Total	
<b>Peak Hour Analysis From 07:00 AM to 08:45 AM - Peak 1 of 1</b>																	
<b>Peak Hour for Entire Intersection Begins at 07:45 AM</b>																	
07:45 AM	4	<b>10</b>	0	14	0	0	0	0	0	0	6	6	0	2	0	2	22
08:00 AM	4	10	0	14	0	0	0	0	0	0	4	4	0	0	0	0	18
08:15 AM	5	9	0	14	0	0	0	0	0	0	7	7	0	<b>5</b>	0	<b>5</b>	26
08:30 AM	<b>7</b>	8	0	<b>15</b>	0	0	0	0	0	0	<b>14</b>	<b>14</b>	0	1	0	1	<b>30</b>
<b>Total Volume</b>	20	37	0	57	0	0	0	0	0	0	31	31	0	8	0	8	96
<b>% App. Total</b>	35.1	64.9	0		0	0	0		0	0	100		0	100	0		
PHF	.714	.925	.000	.950	.000	.000	.000	.000	.000	.000	.554	.554	.000	.400	.000	.400	.800

# Accurate Counts

978-664-2565

N/S Street : South Street  
 E/W Street : School St / Church Driveway  
 City/State : Bridgewater, MA  
 Weather : Clear

File Name : 20270B11  
 Site Code : 20270011  
 Start Date : 10/2/2024  
 Page No : 8

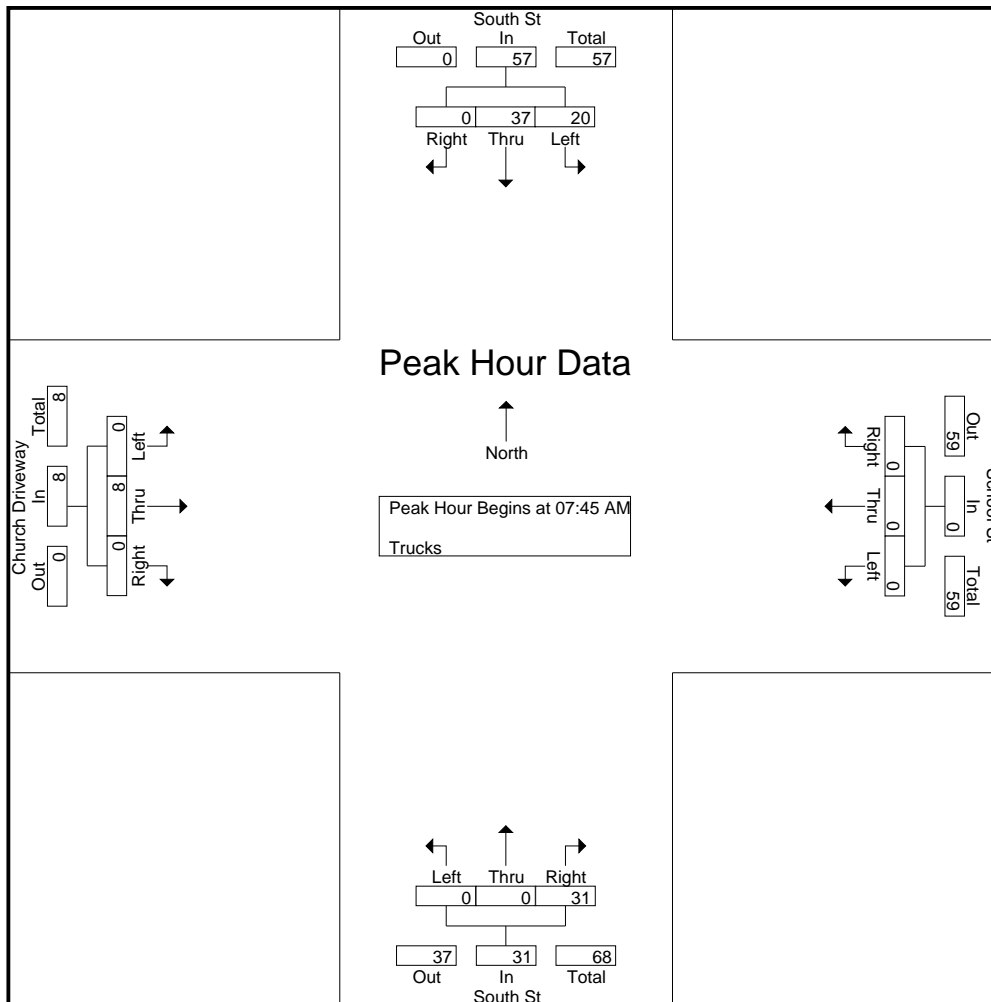

**Peak Hour Analysis From 07:00 AM to 08:45 AM - Peak 1 of 1**

Peak Hour for Each Approach Begins at:

	08:00 AM				07:00 AM				07:00 AM				07:30 AM			
+0 mins.	4	10	0	14	0	0	0	0	0	0	9	9	0	2	0	2
+15 mins.	5	9	0	14	0	0	0	0	0	0	4	4	0	2	0	2
+30 mins.	7	8	0	15	0	0	0	0	0	0	13	13	0	0	0	0
+45 mins.	7	9	0	16	0	0	0	0	0	0	6	6	0	5	0	5
Total Volume	23	36	0	59	0	0	0	0	0	0	32	32	0	9	0	9
% App. Total	39	61	0		0	0	0		0	0	100		0	100	0	
PHF	.821	.900	.000	.922	.000	.000	.000	.000	.000	.000	.615	.615	.000	.450	.000	.450



# Accurate Counts

978-664-2565

File Name : 20270B11

Site Code : 20270011

Start Date : 10/2/2024

Page No : 9

N/S Street : South Street  
E/W Street : School St / Church Driveway  
City/State : Bridgewater, MA  
Weather : Clear

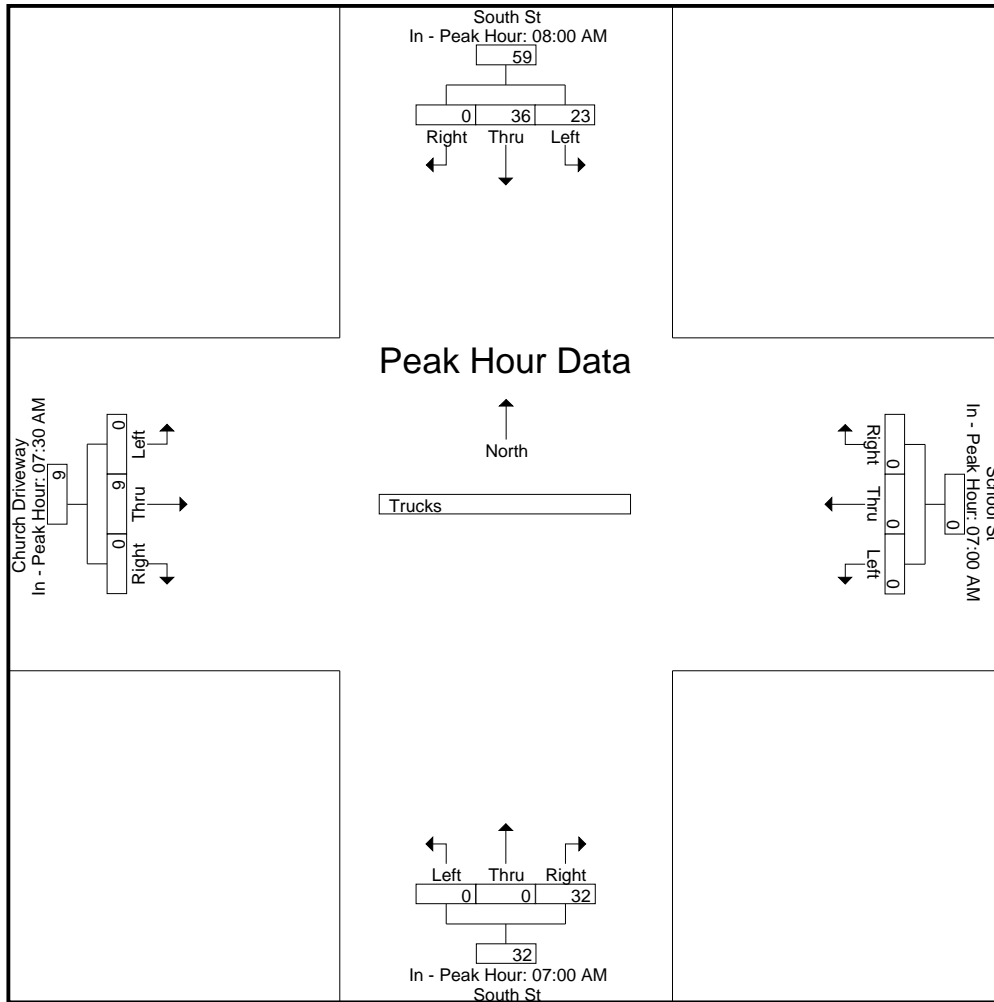

# Accurate Counts

978-664-2565

N/S Street : South Street  
 E/W Street : School St / Church Driveway  
 City/State : Bridgewater, MA  
 Weather : Clear

File Name : 20270B11  
 Site Code : 20270011  
 Start Date : 10/2/2024  
 Page No : 10

### Groups Printed- Bikes Peds

Start Time	South St From North				School St From East				South St From South				Church Driveway From West				Exclu. Total	Inclu. Total	Int. Total
	Left	Thru	Right	Peds	Left	Thru	Right	Peds	Left	Thru	Right	Peds	Left	Thru	Right	Peds			
07:00 AM	0	0	0	0	0	0	0	0	0	0	0	2	0	0	0	1	3	0	3
07:15 AM	0	0	0	0	0	0	0	0	0	0	0	0	0	0	0	2	2	0	2
07:30 AM	0	0	0	0	0	0	0	0	0	0	0	0	0	0	0	1	1	0	1
07:45 AM	0	0	0	1	0	0	0	0	0	0	0	1	0	0	0	0	2	0	2
<b>Total</b>	0	0	0	1	0	0	0	0	0	0	0	3	0	0	0	4	8	0	8
08:00 AM	0	0	0	0	0	0	0	0	0	0	0	4	0	0	0	4	8	0	8
08:15 AM	0	0	0	0	0	0	0	0	0	0	0	1	0	0	0	3	4	0	4
08:30 AM	0	0	0	0	0	0	0	0	0	0	1	3	0	0	0	2	5	1	6
08:45 AM	0	0	0	0	0	0	0	0	0	0	0	3	0	0	0	0	3	0	3
<b>Total</b>	0	0	0	0	0	0	0	0	0	0	1	11	0	0	0	9	20	1	21
<b>Grand Total</b>	0	0	0	1	0	0	0	0	0	0	1	14	0	0	0	13	28	1	29
Apprch %	0	0	0		0	0	0		0	0	100		0	0	0				
Total %	0	0	0		0	0	0		0	0	100		0	0	0		96.6	3.4	

Start Time	South St From North				School St From East				South St From South				Church Driveway From West				Int. Total
	Left	Thru	Right	App. Total	Left	Thru	Right	App. Total	Left	Thru	Right	App. Total	Left	Thru	Right	App. Total	
<b>Peak Hour Analysis From 07:00 AM to 08:45 AM - Peak 1 of 1</b>																	
<b>Peak Hour for Entire Intersection Begins at 07:45 AM</b>																	
07:45 AM	0	0	0	0	0	0	0	0	0	0	0	0	0	0	0	0	0
08:00 AM	0	0	0	0	0	0	0	0	0	0	0	0	0	0	0	0	0
08:15 AM	0	0	0	0	0	0	0	0	0	0	0	0	0	0	0	0	0
08:30 AM	0	0	0	0	0	0	0	0	0	0	1	1	0	0	0	0	1
<b>Total Volume</b>	0	0	0	0	0	0	0	0	0	0	1	1	0	0	0	0	1
<b>% App. Total</b>	0	0	0		0	0	0		0	0	100		0	0	0		
PHF	.000	.000	.000	.000	.000	.000	.000	.000	.000	.000	.250	.250	.000	.000	.000	.000	.250

# Accurate Counts

978-664-2565

N/S Street : South Street  
 E/W Street : School St / Church Driveway  
 City/State : Bridgewater, MA  
 Weather : Clear

File Name : 20270B11  
 Site Code : 20270011  
 Start Date : 10/2/2024  
 Page No : 11

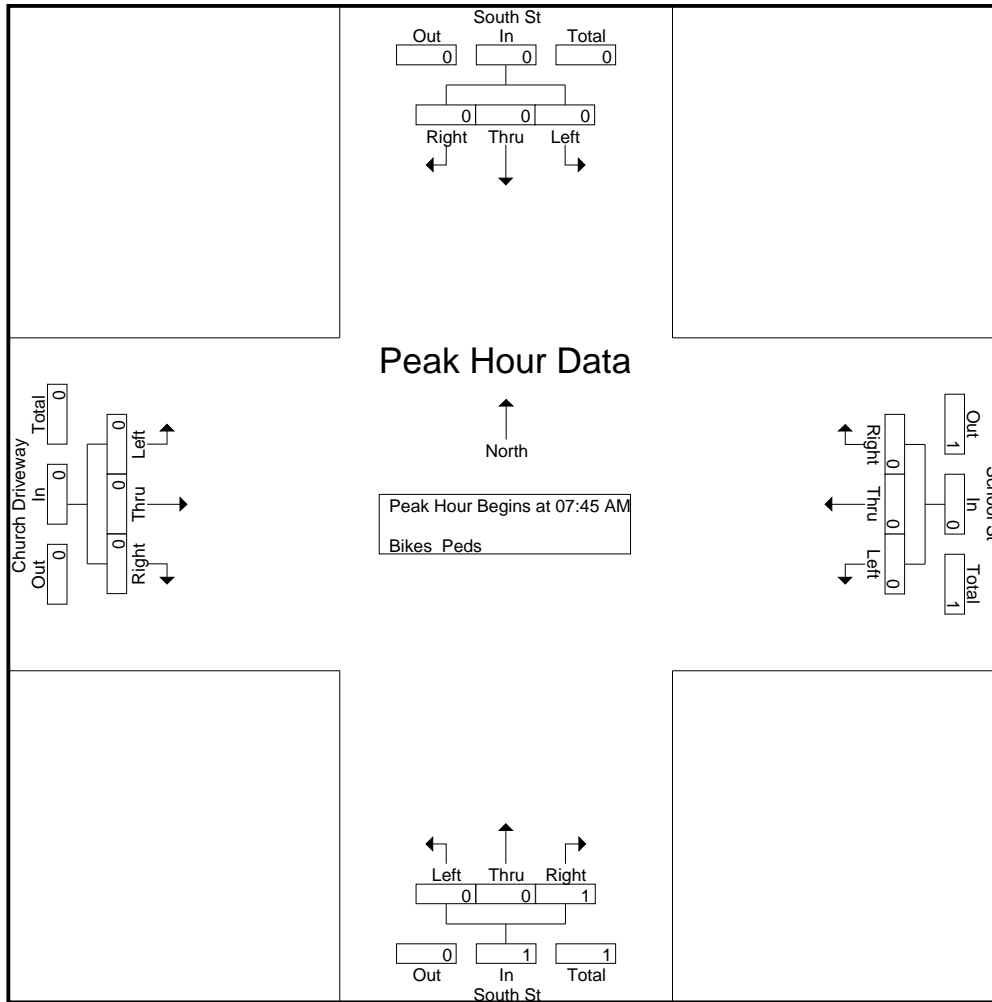

**Peak Hour Analysis From 07:00 AM to 08:45 AM - Peak 1 of 1**

Peak Hour for Each Approach Begins at:

	07:00 AM				07:00 AM				07:45 AM				07:00 AM			
+0 mins.	0	0	0	0	0	0	0	0	0	0	0	0	0	0	0	0
+15 mins.	0	0	0	0	0	0	0	0	0	0	0	0	0	0	0	0
+30 mins.	0	0	0	0	0	0	0	0	0	0	0	0	0	0	0	0
+45 mins.	0	0	0	0	0	0	0	0	0	0	1	1	0	0	0	0
Total Volume	0	0	0	0	0	0	0	0	0	0	1	1	0	0	0	0
% App. Total	0	0	0	0	0	0	0	0	0	0	100	100	0	0	0	0
PHF	.000	.000	.000	.000	.000	.000	.000	.000	.000	.000	.250	.250	.000	.000	.000	.000

# Accurate Counts

978-664-2565

File Name : 20270B11

Site Code : 20270011

Start Date : 10/2/2024

Page No : 12

N/S Street : South Street  
E/W Street : School St / Church Driveway  
City/State : Bridgewater, MA  
Weather : Clear

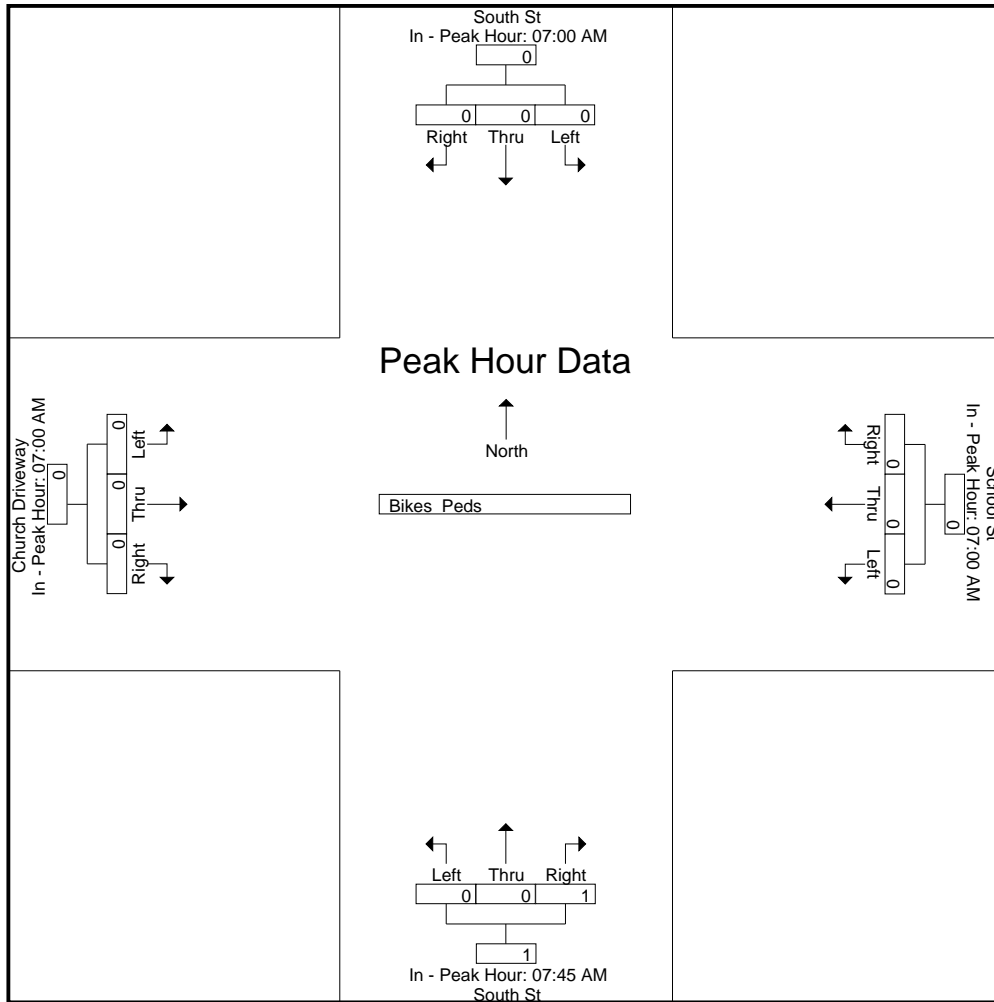

# Accurate Counts

978-664-2565

N/S Street : South Street  
 E/W Street : School St / Church Driveway  
 City/State : Bridgewater, MA  
 Weather : Clear

File Name : 20270B11  
 Site Code : 20270011  
 Start Date : 10/2/2024  
 Page No : 1

### Groups Printed- Cars - Trucks

Start Time	South St From North			School St From East			South St From South			Church Driveway From West			Int. Total
	Left	Thru	Right	Left	Thru	Right	Left	Thru	Right	Left	Thru	Right	
04:00 PM	141	144	2	0	0	0	0	0	127	0	9	7	430
04:15 PM	143	123	4	0	0	0	0	0	128	0	9	3	410
04:30 PM	171	135	0	0	0	0	0	0	120	0	3	2	431
04:45 PM	140	120	1	0	0	0	0	0	118	0	7	3	389
<b>Total</b>	<b>595</b>	<b>522</b>	<b>7</b>	<b>0</b>	<b>0</b>	<b>0</b>	<b>0</b>	<b>0</b>	<b>493</b>	<b>0</b>	<b>28</b>	<b>15</b>	<b>1660</b>
05:00 PM	170	139	2	0	0	0	0	0	118	0	11	3	443
05:15 PM	158	139	1	0	0	0	0	0	128	0	15	3	444
05:30 PM	141	146	2	0	0	0	0	0	127	0	8	0	424
05:45 PM	143	118	0	0	0	0	0	0	137	0	6	0	404
<b>Total</b>	<b>612</b>	<b>542</b>	<b>5</b>	<b>0</b>	<b>0</b>	<b>0</b>	<b>0</b>	<b>0</b>	<b>510</b>	<b>0</b>	<b>40</b>	<b>6</b>	<b>1715</b>
<b>Grand Total</b>	<b>1207</b>	<b>1064</b>	<b>12</b>	<b>0</b>	<b>0</b>	<b>0</b>	<b>0</b>	<b>0</b>	<b>1003</b>	<b>0</b>	<b>68</b>	<b>21</b>	<b>3375</b>
Apprch %	52.9	46.6	0.5	0	0	0	0	0	100	0	76.4	23.6	
Total %	35.8	31.5	0.4	0	0	0	0	0	29.7	0	2	0.6	
Cars	1192	1046	12	0	0	0	0	0	980	0	68	21	3319
% Cars	98.8	98.3	100	0	0	0	0	0	97.7	0	100	100	98.3
Trucks	15	18	0	0	0	0	0	0	23	0	0	0	56
% Trucks	1.2	1.7	0	0	0	0	0	0	2.3	0	0	0	1.7

Start Time	South St From North				School St From East				South St From South				Church Driveway From West				Int. Total
	Left	Thru	Right	App. Total	Left	Thru	Right	App. Total	Left	Thru	Right	App. Total	Left	Thru	Right	App. Total	
Peak Hour Analysis From 04:00 PM to 05:45 PM - Peak 1 of 1																	
Peak Hour for Entire Intersection Begins at 05:00 PM																	
05:00 PM	<b>170</b>	139	<b>2</b>	<b>311</b>	0	0	0	0	0	0	118	118	0	11	<b>3</b>	14	443
05:15 PM	158	139	1	298	0	0	0	0	0	0	128	128	0	<b>15</b>	3	<b>18</b>	<b>444</b>
05:30 PM	141	<b>146</b>	2	289	0	0	0	0	0	0	127	127	0	8	0	8	424
05:45 PM	143	118	0	261	0	0	0	0	0	0	<b>137</b>	<b>137</b>	0	6	0	6	404
<b>Total Volume</b>	<b>612</b>	<b>542</b>	<b>5</b>	<b>1159</b>	<b>0</b>	<b>0</b>	<b>0</b>	<b>0</b>	<b>0</b>	<b>0</b>	<b>510</b>	<b>510</b>	<b>0</b>	<b>40</b>	<b>6</b>	<b>46</b>	<b>1715</b>
% App. Total	52.8	46.8	0.4		0	0	0		0	0	100		0	87	13		
PHF	.900	.928	.625	.932	.000	.000	.000	.000	.000	.000	.931	.931	.000	.667	.500	.639	.966
Cars	606	540	5	1151	0	0	0	0	0	0	502	502	0	40	6	46	1699
% Cars	99.0	99.6	100	99.3	0	0	0	0	0	0	98.4	98.4	0	100	100	100	99.1
Trucks	6	2	0	8	0	0	0	0	0	0	8	8	0	0	0	0	16
% Trucks	1.0	0.4	0	0.7	0	0	0	0	0	0	1.6	1.6	0	0	0	0	0.9

# Accurate Counts

978-664-2565

N/S Street : South Street  
 E/W Street : School St / Church Driveway  
 City/State : Bridgewater, MA  
 Weather : Clear

File Name : 20270B11  
 Site Code : 20270011  
 Start Date : 10/2/2024  
 Page No : 2

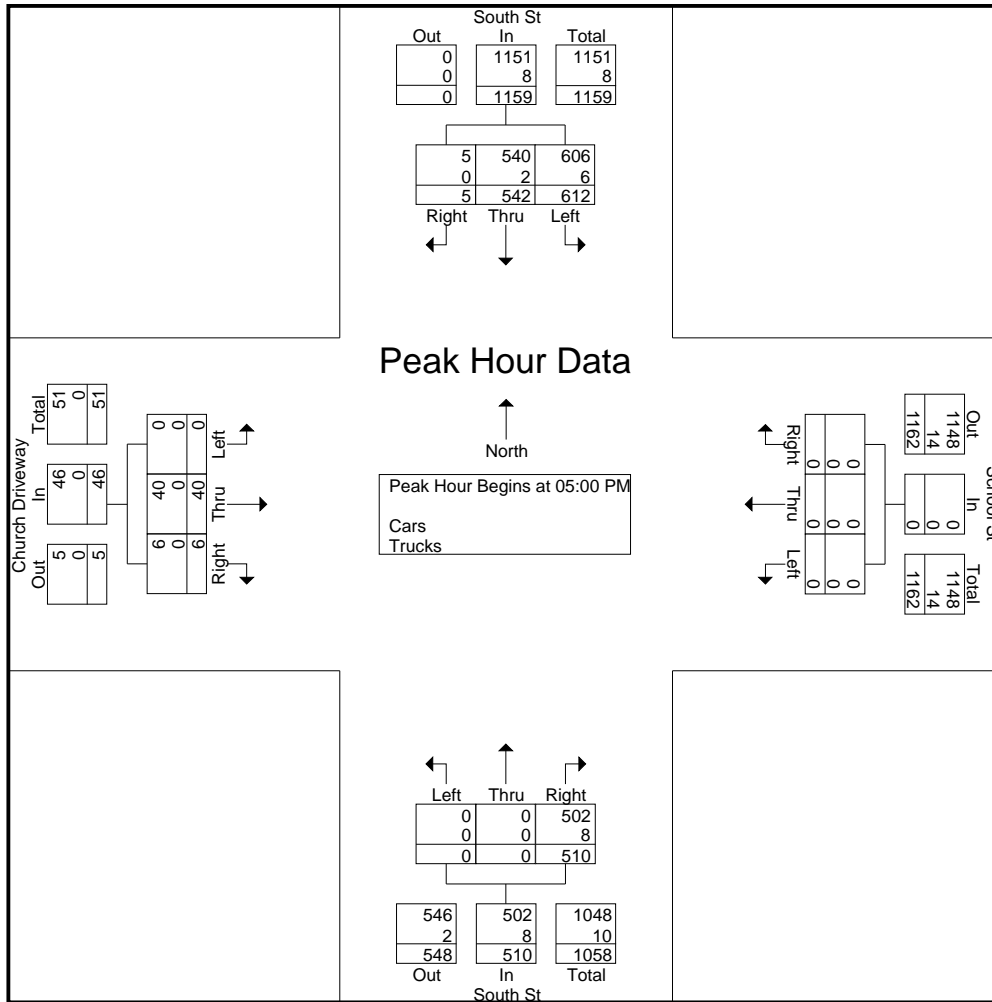

**Peak Hour Analysis From 04:00 PM to 05:45 PM - Peak 1 of 1**

**Peak Hour for Each Approach Begins at:**

	04:30 PM				04:00 PM				05:00 PM				04:45 PM			
+0 mins.	171	135	0	306	0	0	0	0	0	0	118	118	0	7	3	10
+15 mins.	140	120	1	261	0	0	0	0	0	0	128	128	0	11	3	14
+30 mins.	170	139	2	311	0	0	0	0	0	0	127	127	0	15	3	18
+45 mins.	158	139	1	298	0	0	0	0	0	0	137	137	0	8	0	8
Total Volume	639	533	4	1176	0	0	0	0	0	0	510	510	0	41	9	50
% App. Total	54.3	45.3	0.3		0	0	0	0	0	0	100		0	82	18	
PHF	.934	.959	.500	.945	.000	.000	.000	.000	.000	.000	.931	.931	.000	.683	.750	.694
Cars	631	527	4	1162	0	0	0	0	0	0	502	502	0	41	9	50
% Cars	98.7	98.9	100	98.8	0	0	0	0	0	0	98.4	98.4	0	100	100	100
Trucks	8	6	0	14	0	0	0	0	0	0	8	8	0	0	0	0
% Trucks	1.3	1.1	0	1.2	0	0	0	0	0	0	1.6	1.6	0	0	0	0

# Accurate Counts

978-664-2565

File Name : 20270B11

Site Code : 20270011

Start Date : 10/2/2024

Page No : 3

N/S Street : South Street  
 E/W Street : School St / Church Driveway  
 City/State : Bridgewater, MA  
 Weather : Clear

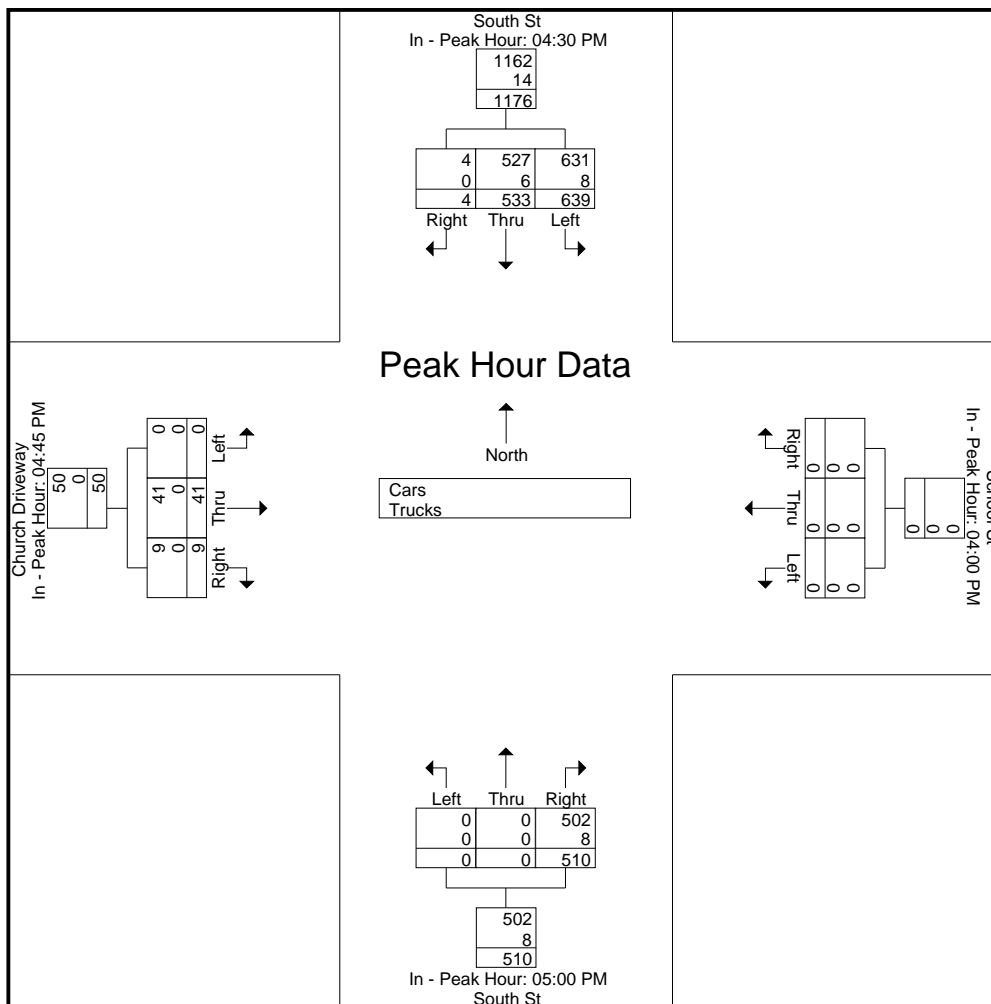

# Accurate Counts

978-664-2565

N/S Street : South Street  
 E/W Street : School St / Church Driveway  
 City/State : Bridgewater, MA  
 Weather : Clear

File Name : 20270B11  
 Site Code : 20270011  
 Start Date : 10/2/2024  
 Page No : 4

## Groups Printed- Cars

Start Time	South St From North			School St From East			South St From South			Church Driveway From West			Int. Total
	Left	Thru	Right	Left	Thru	Right	Left	Thru	Right	Left	Thru	Right	
04:00 PM	137	139	2	0	0	0	0	0	125	0	9	7	419
04:15 PM	142	116	4	0	0	0	0	0	125	0	9	3	399
04:30 PM	168	134	0	0	0	0	0	0	113	0	3	2	420
04:45 PM	139	117	1	0	0	0	0	0	115	0	7	3	382
<b>Total</b>	<b>586</b>	<b>506</b>	<b>7</b>	<b>0</b>	<b>0</b>	<b>0</b>	<b>0</b>	<b>0</b>	<b>478</b>	<b>0</b>	<b>28</b>	<b>15</b>	<b>1620</b>
05:00 PM	167	138	2	0	0	0	0	0	116	0	11	3	437
05:15 PM	157	138	1	0	0	0	0	0	125	0	15	3	439
05:30 PM	140	146	2	0	0	0	0	0	125	0	8	0	421
05:45 PM	142	118	0	0	0	0	0	0	136	0	6	0	402
<b>Total</b>	<b>606</b>	<b>540</b>	<b>5</b>	<b>0</b>	<b>0</b>	<b>0</b>	<b>0</b>	<b>0</b>	<b>502</b>	<b>0</b>	<b>40</b>	<b>6</b>	<b>1699</b>
<b>Grand Total</b>	<b>1192</b>	<b>1046</b>	<b>12</b>	<b>0</b>	<b>0</b>	<b>0</b>	<b>0</b>	<b>0</b>	<b>980</b>	<b>0</b>	<b>68</b>	<b>21</b>	<b>3319</b>
Apprch %	53	46.5	0.5	0	0	0	0	0	100	0	76.4	23.6	
Total %	35.9	31.5	0.4	0	0	0	0	0	29.5	0	2	0.6	

Start Time	South St From North				School St From East				South St From South				Church Driveway From West				Int. Total
	Left	Thru	Right	App. Total	Left	Thru	Right	App. Total	Left	Thru	Right	App. Total	Left	Thru	Right	App. Total	
<b>Peak Hour Analysis From 04:00 PM to 05:45 PM - Peak 1 of 1</b>																	
<b>Peak Hour for Entire Intersection Begins at 05:00 PM</b>																	
05:00 PM	<b>167</b>	138	<b>2</b>	<b>307</b>	0	0	0	0	0	0	116	116	0	11	<b>3</b>	14	437
05:15 PM	157	138	1	296	0	0	0	0	0	0	125	125	0	<b>15</b>	3	<b>18</b>	<b>439</b>
05:30 PM	140	<b>146</b>	2	288	0	0	0	0	0	0	125	125	0	8	0	8	421
05:45 PM	142	118	0	260	0	0	0	0	0	0	<b>136</b>	<b>136</b>	0	6	0	6	402
<b>Total Volume</b>	<b>606</b>	<b>540</b>	<b>5</b>	<b>1151</b>	<b>0</b>	<b>0</b>	<b>0</b>	<b>0</b>	<b>0</b>	<b>0</b>	<b>502</b>	<b>502</b>	<b>0</b>	<b>40</b>	<b>6</b>	<b>46</b>	<b>1699</b>
<b>% App. Total</b>	<b>52.6</b>	<b>46.9</b>	<b>0.4</b>		<b>0</b>	<b>0</b>	<b>0</b>		<b>0</b>	<b>0</b>	<b>100</b>		<b>0</b>	<b>87</b>	<b>13</b>		
PHF	.907	.925	.625	.937	.000	.000	.000	.000	.000	.000	.923	.923	.000	.667	.500	.639	.968



# Accurate Counts

978-664-2565

N/S Street : South Street  
 E/W Street : School St / Church Driveway  
 City/State : Bridgewater, MA  
 Weather : Clear

File Name : 20270B11  
 Site Code : 20270011  
 Start Date : 10/2/2024  
 Page No : 5

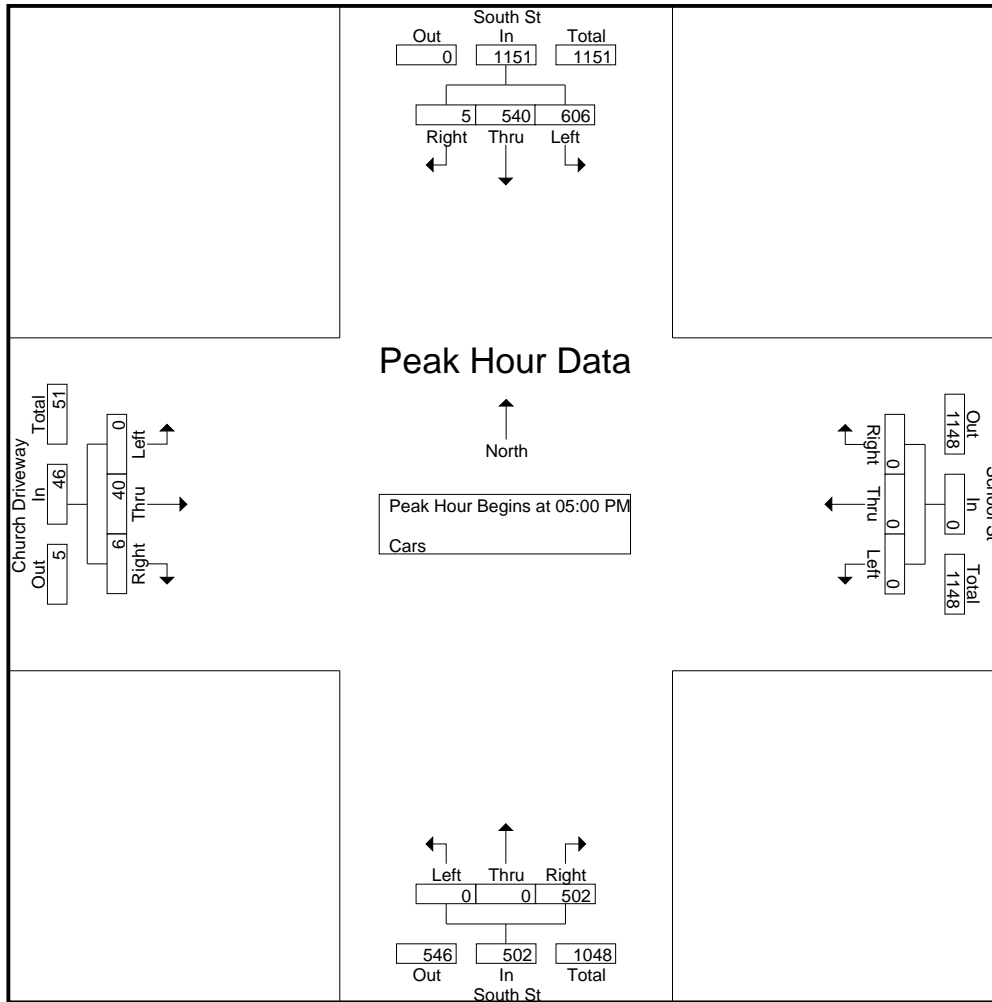

**Peak Hour Analysis From 04:00 PM to 05:45 PM - Peak 1 of 1**

**Peak Hour for Each Approach Begins at:**

	04:30 PM				04:00 PM				05:00 PM				04:45 PM			
+0 mins.	<b>168</b>	134	0	302	0	0	0	0	0	0	116	116	0	7	<b>3</b>	10
+15 mins.	139	117	1	257	0	0	0	0	0	0	125	125	0	11	3	14
+30 mins.	167	<b>138</b>	<b>2</b>	<b>307</b>	0	0	0	0	0	0	125	125	0	<b>15</b>	3	<b>18</b>
+45 mins.	157	138	1	296	0	0	0	0	0	0	<b>136</b>	<b>136</b>	0	8	0	8
Total Volume	631	527	4	1162	0	0	0	0	0	0	502	502	0	41	9	50
% App. Total	54.3	45.4	0.3		0	0	0	0	0	0	100		0	82	18	
PHF	.939	.955	.500	.946	.000	.000	.000	.000	.000	.000	.923	.923	.000	.683	.750	.694

# Accurate Counts

978-664-2565

File Name : 20270B11

Site Code : 20270011

Start Date : 10/2/2024

Page No : 6

N/S Street : South Street  
 E/W Street : School St / Church Driveway  
 City/State : Bridgewater, MA  
 Weather : Clear

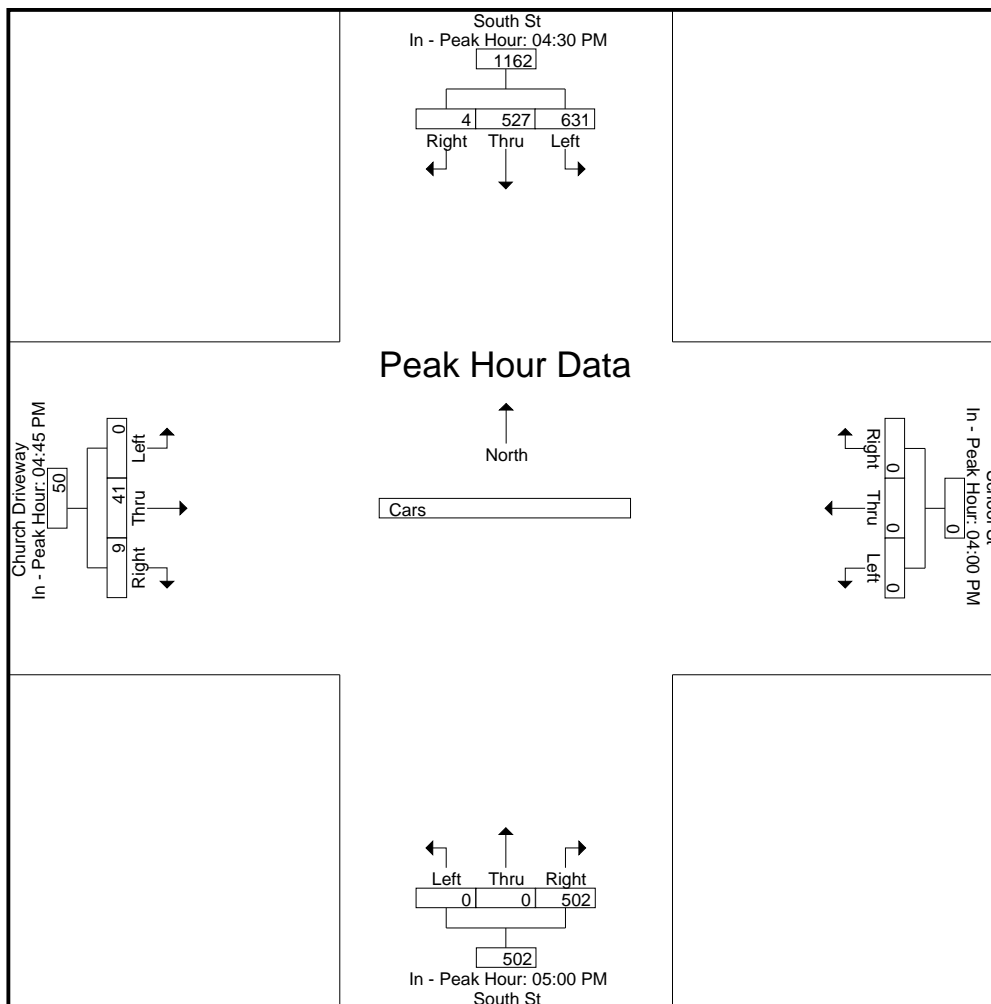

# Accurate Counts

978-664-2565

N/S Street : South Street  
 E/W Street : School St / Church Driveway  
 City/State : Bridgewater, MA  
 Weather : Clear

File Name : 20270B11  
 Site Code : 20270011  
 Start Date : 10/2/2024  
 Page No : 7

### Groups Printed- Trucks

Start Time	South St From North			School St From East			South St From South			Church Driveway From West			Int. Total
	Left	Thru	Right	Left	Thru	Right	Left	Thru	Right	Left	Thru	Right	
04:00 PM	4	5	0	0	0	0	0	0	2	0	0	0	11
04:15 PM	1	7	0	0	0	0	0	0	3	0	0	0	11
04:30 PM	3	1	0	0	0	0	0	0	7	0	0	0	11
04:45 PM	1	3	0	0	0	0	0	0	3	0	0	0	7
<b>Total</b>	<b>9</b>	<b>16</b>	<b>0</b>	<b>0</b>	<b>0</b>	<b>0</b>	<b>0</b>	<b>0</b>	<b>15</b>	<b>0</b>	<b>0</b>	<b>0</b>	<b>40</b>
05:00 PM	3	1	0	0	0	0	0	0	2	0	0	0	6
05:15 PM	1	1	0	0	0	0	0	0	3	0	0	0	5
05:30 PM	1	0	0	0	0	0	0	0	2	0	0	0	3
05:45 PM	1	0	0	0	0	0	0	0	1	0	0	0	2
<b>Total</b>	<b>6</b>	<b>2</b>	<b>0</b>	<b>0</b>	<b>0</b>	<b>0</b>	<b>0</b>	<b>0</b>	<b>8</b>	<b>0</b>	<b>0</b>	<b>0</b>	<b>16</b>
<b>Grand Total</b>	<b>15</b>	<b>18</b>	<b>0</b>	<b>0</b>	<b>0</b>	<b>0</b>	<b>0</b>	<b>0</b>	<b>23</b>	<b>0</b>	<b>0</b>	<b>0</b>	<b>56</b>
Apprch %	45.5	54.5	0	0	0	0	0	0	100	0	0	0	
Total %	26.8	32.1	0	0	0	0	0	0	41.1	0	0	0	

Start Time	South St From North				School St From East				South St From South				Church Driveway From West				Int. Total
	Left	Thru	Right	App. Total	Left	Thru	Right	App. Total	Left	Thru	Right	App. Total	Left	Thru	Right	App. Total	
<b>Peak Hour Analysis From 04:00 PM to 05:45 PM - Peak 1 of 1</b>																	
<b>Peak Hour for Entire Intersection Begins at 04:00 PM</b>																	
04:00 PM	4	5	0	9	0	0	0	0	0	0	2	2	0	0	0	0	11
04:15 PM	1	7	0	8	0	0	0	0	0	0	3	3	0	0	0	0	11
04:30 PM	3	1	0	4	0	0	0	0	0	0	7	7	0	0	0	0	11
04:45 PM	1	3	0	4	0	0	0	0	0	0	3	3	0	0	0	0	7
<b>Total Volume</b>	<b>9</b>	<b>16</b>	<b>0</b>	<b>25</b>	<b>0</b>	<b>0</b>	<b>0</b>	<b>0</b>	<b>0</b>	<b>0</b>	<b>15</b>	<b>15</b>	<b>0</b>	<b>0</b>	<b>0</b>	<b>0</b>	<b>40</b>
<b>% App. Total</b>	<b>36</b>	<b>64</b>	<b>0</b>		<b>0</b>	<b>0</b>	<b>0</b>		<b>0</b>	<b>0</b>	<b>100</b>		<b>0</b>	<b>0</b>	<b>0</b>		
PHF	.563	.571	.000	.694	.000	.000	.000	.000	.000	.000	.536	.536	.000	.000	.000	.000	.909

# Accurate Counts

978-664-2565

N/S Street : South Street  
 E/W Street : School St / Church Driveway  
 City/State : Bridgewater, MA  
 Weather : Clear

File Name : 20270B11  
 Site Code : 20270011  
 Start Date : 10/2/2024  
 Page No : 8

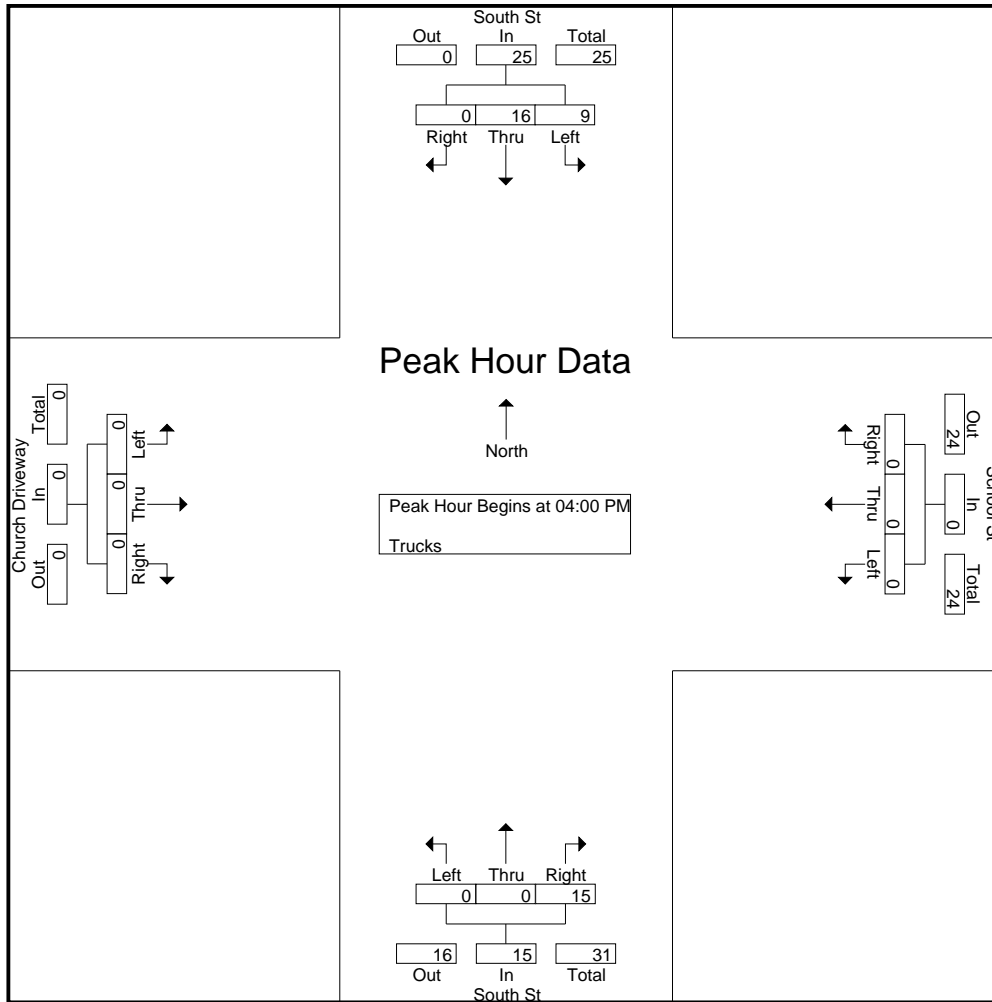

**Peak Hour Analysis From 04:00 PM to 05:45 PM - Peak 1 of 1**

**Peak Hour for Each Approach Begins at:**

	04:00 PM				04:00 PM				04:00 PM				04:00 PM			
+0 mins.	4	5	0	9	0	0	0	0	0	0	2	2	0	0	0	0
+15 mins.	1	7	0	8	0	0	0	0	0	0	3	3	0	0	0	0
+30 mins.	3	1	0	4	0	0	0	0	0	0	7	7	0	0	0	0
+45 mins.	1	3	0	4	0	0	0	0	0	0	3	3	0	0	0	0
Total Volume	9	16	0	25	0	0	0	0	0	0	15	15	0	0	0	0
% App. Total	36	64	0		0	0	0		0	0	100		0	0	0	
PHF	.563	.571	.000	.694	.000	.000	.000	.000	.000	.000	.536	.536	.000	.000	.000	.000

# Accurate Counts

978-664-2565

N/S Street : South Street  
E/W Street : School St / Church Driveway  
City/State : Bridgewater, MA  
Weather : Clear

File Name : 20270B11  
Site Code : 20270011  
Start Date : 10/2/2024  
Page No : 9

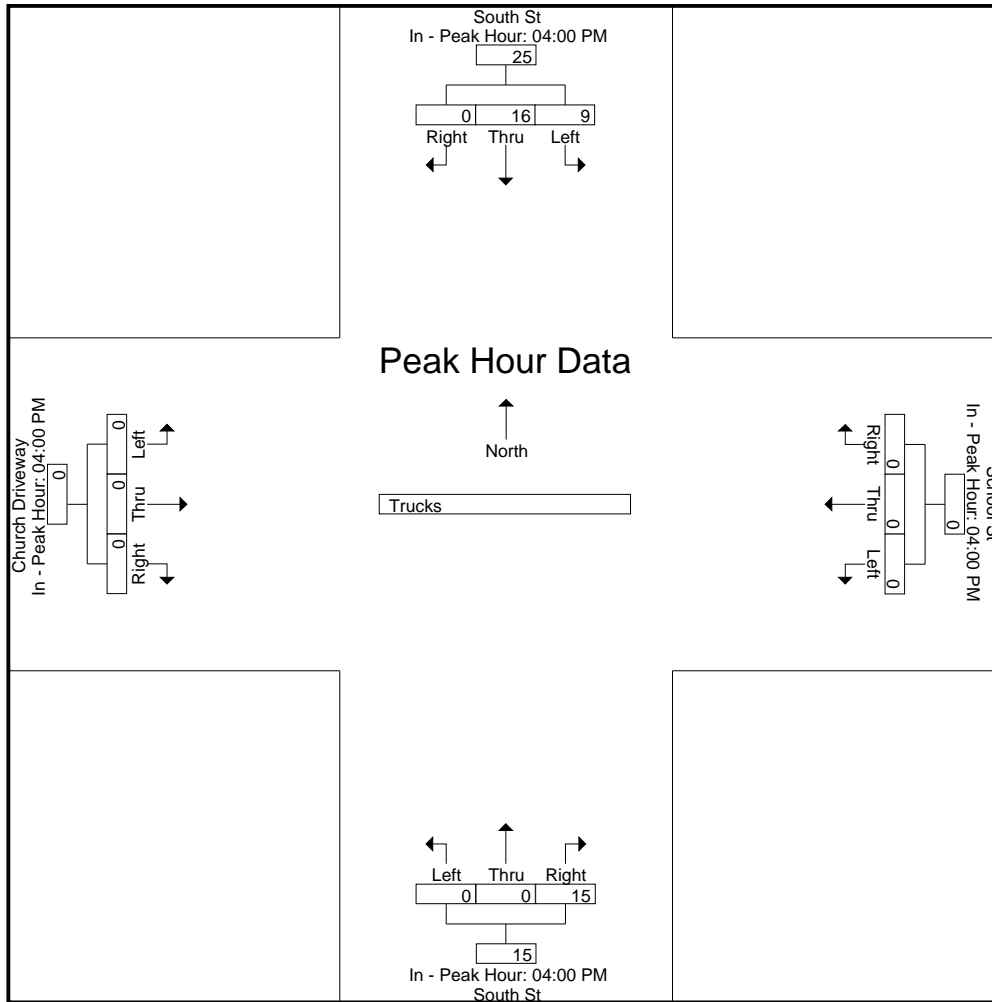

# Accurate Counts

978-664-2565

N/S Street : South Street  
 E/W Street : School St / Church Driveway  
 City/State : Bridgewater, MA  
 Weather : Clear

File Name : 20270B11  
 Site Code : 20270011  
 Start Date : 10/2/2024  
 Page No : 10

### Groups Printed- Bikes Peds

Start Time	South St From North				School St From East				South St From South				Church Driveway From West				Exclu. Total	Inclu. Total	Int. Total
	Left	Thru	Right	Peds	Left	Thru	Right	Peds	Left	Thru	Right	Peds	Left	Thru	Right	Peds			
04:00 PM	0	0	0	0	0	0	0	0	0	0	0	7	0	0	0	13	20	0	20
04:15 PM	0	0	0	1	0	0	0	0	0	0	0	0	0	0	0	1	2	0	2
04:30 PM	0	0	0	0	0	0	0	0	0	0	1	0	0	0	0	4	4	1	5
04:45 PM	0	0	0	0	0	0	0	0	0	0	0	2	0	0	0	2	4	0	4
<b>Total</b>	0	0	0	1	0	0	0	0	0	0	1	9	0	0	0	20	30	1	31
05:00 PM	0	0	0	2	0	0	0	0	0	0	0	5	0	0	0	2	9	0	9
05:15 PM	0	0	0	0	0	0	0	0	0	0	0	2	0	0	0	1	3	0	3
05:30 PM	0	0	0	0	0	0	0	0	0	0	0	0	0	0	0	2	2	0	2
05:45 PM	0	0	0	0	0	0	0	0	0	0	0	0	0	0	0	0	0	0	0
<b>Total</b>	0	0	0	2	0	0	0	0	0	0	0	7	0	0	0	5	14	0	14
<b>Grand Total</b>	0	0	0	3	0	0	0	0	0	0	1	16	0	0	0	25	44	1	45
Apprch %	0	0	0		0	0	0		0	0	100		0	0	0				
Total %	0	0	0		0	0	0		0	0	100		0	0	0		97.8	2.2	

Start Time	South St From North				School St From East				South St From South				Church Driveway From West				Int. Total	
	Left	Thru	Right	App. Total	Left	Thru	Right	App. Total	Left	Thru	Right	App. Total	Left	Thru	Right	App. Total		
<b>Peak Hour Analysis From 04:00 PM to 05:45 PM - Peak 1 of 1</b>																		
<b>Peak Hour for Entire Intersection Begins at 04:00 PM</b>																		
04:00 PM	0	0	0	0	0	0	0	0	0	0	0	0	0	0	0	0	0	0
04:15 PM	0	0	0	0	0	0	0	0	0	0	0	0	0	0	0	0	0	0
04:30 PM	0	0	0	0	0	0	0	0	0	0	1	1	0	0	0	0	0	1
04:45 PM	0	0	0	0	0	0	0	0	0	0	0	0	0	0	0	0	0	0
<b>Total Volume</b>	0	0	0	0	0	0	0	0	0	0	1	1	0	0	0	0	0	1
<b>% App. Total</b>	0	0	0		0	0	0		0	0	100		0	0	0			
<b>PHF</b>	.000	.000	.000	.000	.000	.000	.000	.000	.000	.000	.250	.250	.000	.000	.000	.000	.000	.250

# Accurate Counts

978-664-2565

N/S Street : South Street  
 E/W Street : School St / Church Driveway  
 City/State : Bridgewater, MA  
 Weather : Clear

File Name : 20270B11  
 Site Code : 20270011  
 Start Date : 10/2/2024  
 Page No : 11

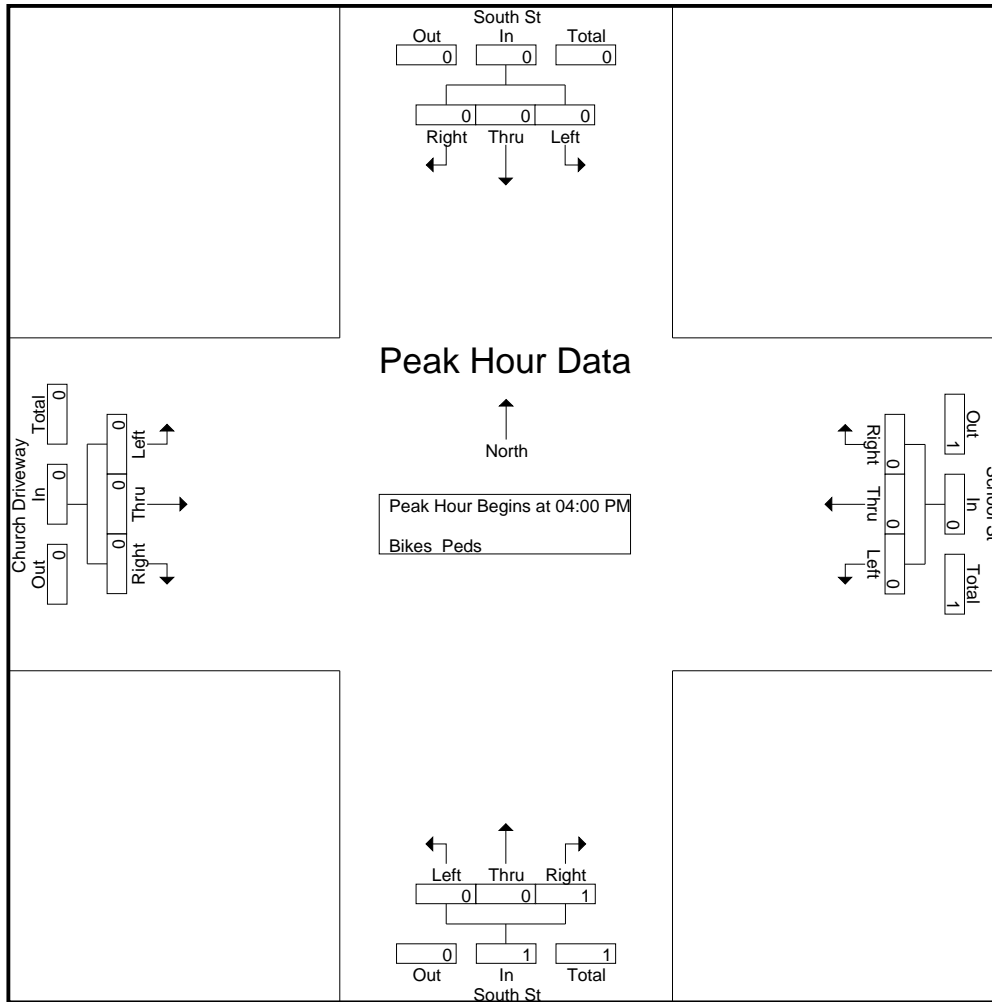

**Peak Hour Analysis From 04:00 PM to 05:45 PM - Peak 1 of 1**

**Peak Hour for Each Approach Begins at:**

	04:00 PM				04:00 PM				04:00 PM				04:00 PM			
+0 mins.	0	0	0	0	0	0	0	0	0	0	0	0	0	0	0	0
+15 mins.	0	0	0	0	0	0	0	0	0	0	0	0	0	0	0	0
+30 mins.	0	0	0	0	0	0	0	0	0	0	1	1	0	0	0	0
+45 mins.	0	0	0	0	0	0	0	0	0	0	0	0	0	0	0	0
Total Volume	0	0	0	0	0	0	0	0	0	0	1	1	0	0	0	0
% App. Total	0	0	0	0	0	0	0	0	0	0	100	100	0	0	0	0
PHF	.000	.000	.000	.000	.000	.000	.000	.000	.000	.000	.250	.250	.000	.000	.000	.000

# Accurate Counts

978-664-2565

File Name : 20270B11

Site Code : 20270011

Start Date : 10/2/2024

Page No : 12

N/S Street : South Street  
E/W Street : School St / Church Driveway  
City/State : Bridgewater, MA  
Weather : Clear

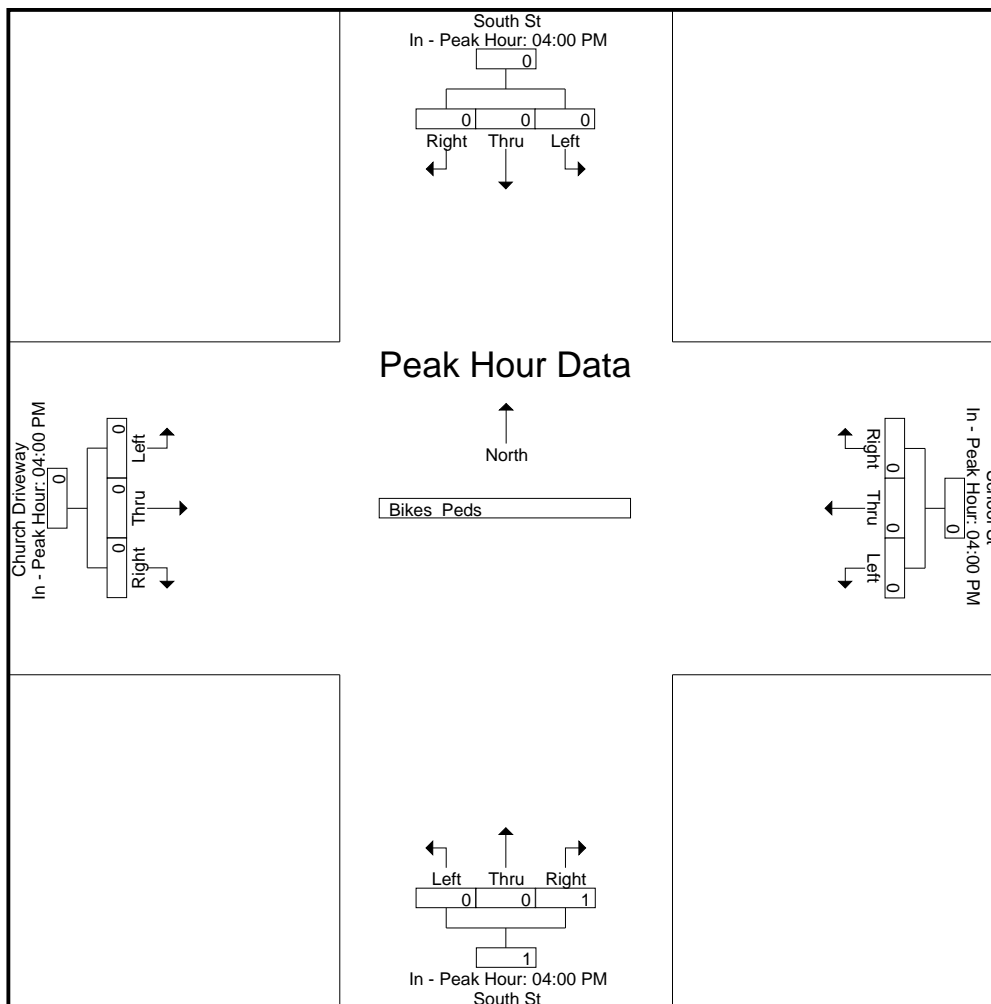



# Accurate Counts

978-664-2565

N/S Street : Bedford Street  
 E/W Street : School Street  
 City/State : Bridgewater, MA  
 Weather : Clear

File Name : 20270B12  
 Site Code : 20270012  
 Start Date : 10/2/2024  
 Page No : 1

### Groups Printed- Cars - Trucks

Start Time	Bedford St From North			School St From East			Bedford St From South			School St From West			Int. Total
	Left	Thru	Right	Left	Thru	Right	Left	Thru	Right	Left	Thru	Right	
07:00 AM	0	0	0	0	0	0	0	91	3	93	17	80	284
07:15 AM	0	0	0	0	4	0	0	87	6	113	20	94	324
07:30 AM	0	0	0	0	0	0	0	116	4	147	17	102	386
07:45 AM	0	0	0	0	0	0	0	108	5	124	37	103	377
<b>Total</b>	<b>0</b>	<b>0</b>	<b>0</b>	<b>0</b>	<b>4</b>	<b>0</b>	<b>0</b>	<b>402</b>	<b>18</b>	<b>477</b>	<b>91</b>	<b>379</b>	<b>1371</b>
08:00 AM	0	0	0	0	0	0	0	99	4	108	30	100	341
08:15 AM	0	0	0	0	0	0	0	98	2	132	28	96	356
08:30 AM	0	0	0	0	0	2	0	95	4	141	27	78	347
08:45 AM	0	0	0	0	0	5	0	121	9	142	36	103	416
<b>Total</b>	<b>0</b>	<b>0</b>	<b>0</b>	<b>0</b>	<b>0</b>	<b>7</b>	<b>0</b>	<b>413</b>	<b>19</b>	<b>523</b>	<b>121</b>	<b>377</b>	<b>1460</b>
<b>Grand Total</b>	<b>0</b>	<b>0</b>	<b>0</b>	<b>0</b>	<b>4</b>	<b>7</b>	<b>0</b>	<b>815</b>	<b>37</b>	<b>1000</b>	<b>212</b>	<b>756</b>	<b>2831</b>
Apprch %	0	0	0	0	36.4	63.6	0	95.7	4.3	50.8	10.8	38.4	
Total %	0	0	0	0	0.1	0.2	0	28.8	1.3	35.3	7.5	26.7	
Cars	0	0	0	0	2	7	0	792	35	935	201	717	2689
% Cars	0	0	0	0	50	100	0	97.2	94.6	93.5	94.8	94.8	95
Trucks	0	0	0	0	2	0	0	23	2	65	11	39	142
% Trucks	0	0	0	0	50	0	0	2.8	5.4	6.5	5.2	5.2	5

Start Time	Bedford St From North				School St From East				Bedford St From South				School St From West				Int. Total
	Left	Thru	Right	App. Total	Left	Thru	Right	App. Total	Left	Thru	Right	App. Total	Left	Thru	Right	App. Total	
Peak Hour Analysis From 07:00 AM to 08:45 AM - Peak 1 of 1																	
Peak Hour for Entire Intersection Begins at 07:30 AM																	
07:30 AM	0	0	0	0	0	0	0	0	0	<b>116</b>	4	<b>120</b>	<b>147</b>	17	102	<b>266</b>	<b>386</b>
07:45 AM	0	0	0	0	0	0	0	0	0	108	<b>5</b>	113	124	<b>37</b>	<b>103</b>	264	377
08:00 AM	0	0	0	0	0	0	0	0	0	99	4	103	108	30	100	238	341
08:15 AM	0	0	0	0	0	0	0	0	0	98	2	100	132	28	96	256	356
<b>Total Volume</b>	<b>0</b>	<b>0</b>	<b>0</b>	<b>0</b>	<b>0</b>	<b>0</b>	<b>0</b>	<b>0</b>	<b>0</b>	<b>421</b>	<b>15</b>	<b>436</b>	<b>511</b>	<b>112</b>	<b>401</b>	<b>1024</b>	<b>1460</b>
% App. Total	0	0	0	0	0	0	0	0	0	96.6	3.4		49.9	10.9	39.2		
PHF	.000	.000	.000	.000	.000	.000	.000	.000	.000	.907	.750	.908	.869	.757	.973	.962	.946
Cars	0	0	0	0	0	0	0	0	0	411	14	425	478	105	383	966	1391
% Cars	0	0	0	0	0	0	0	0	0	97.6	93.3	97.5	93.5	93.8	95.5	94.3	95.3
Trucks	0	0	0	0	0	0	0	0	0	10	1	11	33	7	18	58	69
% Trucks	0	0	0	0	0	0	0	0	0	2.4	6.7	2.5	6.5	6.3	4.5	5.7	4.7

# Accurate Counts

978-664-2565

N/S Street : Bedford Street  
 E/W Street : School Street  
 City/State : Bridgewater, MA  
 Weather : Clear

File Name : 20270B12  
 Site Code : 20270012  
 Start Date : 10/2/2024  
 Page No : 2

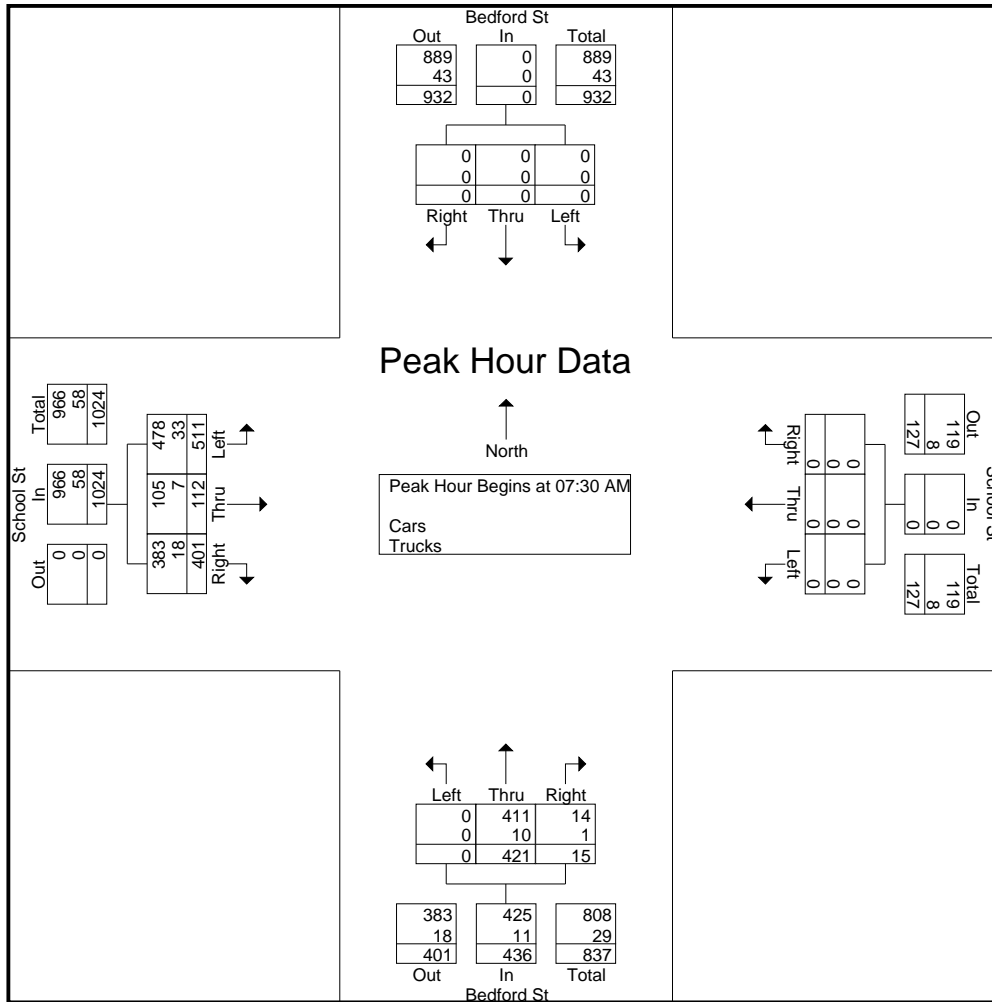

**Peak Hour Analysis From 07:00 AM to 08:45 AM - Peak 1 of 1**

Peak Hour for Each Approach Begins at:

	07:00 AM				08:00 AM				07:30 AM				07:30 AM			
+0 mins.	0	0	0	0	0	0	0	0	0	<b>116</b>	4	<b>120</b>	<b>147</b>	17	102	<b>266</b>
+15 mins.	0	0	0	0	0	0	0	0	0	108	<b>5</b>	113	124	<b>37</b>	<b>103</b>	264
+30 mins.	0	0	0	0	0	0	2	2	0	99	4	103	108	30	100	238
+45 mins.	0	0	0	0	0	0	<b>5</b>	<b>5</b>	0	98	2	100	132	28	96	256
Total Volume	0	0	0	0	0	0	7	7	0	421	15	436	511	112	401	1024
% App. Total	0	0	0	0	0	0	100		0	96.6	3.4		49.9	10.9	39.2	
PHF	.000	.000	.000	.000	.000	.000	.350	.350	.000	.907	.750	.908	.869	.757	.973	.962
Cars	0	0	0	0	0	0	7	7	0	411	14	425	478	105	383	966
% Cars	0	0	0	0	0	0	100	100	0	97.6	93.3	97.5	93.5	93.8	95.5	94.3
Trucks	0	0	0	0	0	0	0	0	0	10	1	11	33	7	18	58
% Trucks	0	0	0	0	0	0	0	0	0	2.4	6.7	2.5	6.5	6.2	4.5	5.7

# Accurate Counts

978-664-2565

N/S Street : Bedford Street  
 E/W Street : School Street  
 City/State : Bridgewater, MA  
 Weather : Clear

File Name : 20270B12  
 Site Code : 20270012  
 Start Date : 10/2/2024  
 Page No : 3

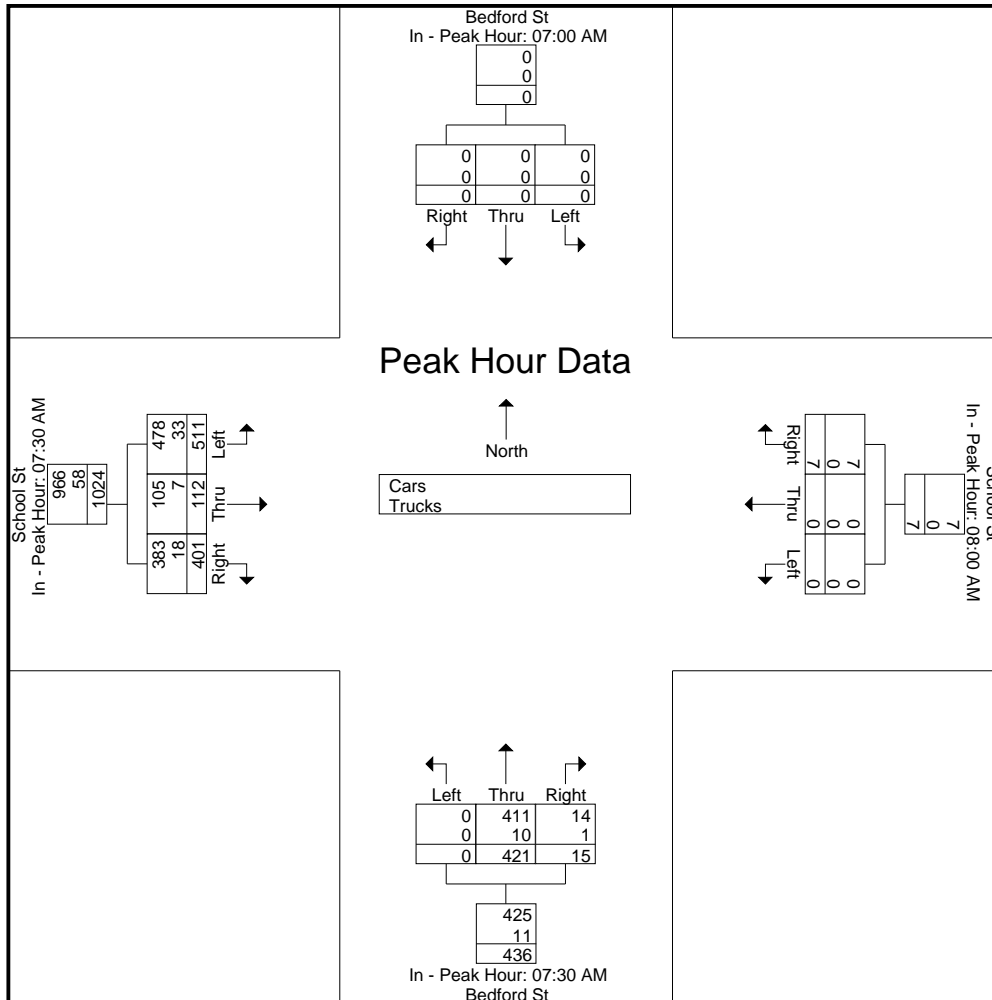

# Accurate Counts

978-664-2565

N/S Street : Bedford Street  
 E/W Street : School Street  
 City/State : Bridgewater, MA  
 Weather : Clear

File Name : 20270B12  
 Site Code : 20270012  
 Start Date : 10/2/2024  
 Page No : 4

## Groups Printed- Cars

Start Time	Bedford St From North			School St From East			Bedford St From South			School St From West			Int. Total
	Left	Thru	Right	Left	Thru	Right	Left	Thru	Right	Left	Thru	Right	
07:00 AM	0	0	0	0	0	0	0	87	3	85	16	78	269
07:15 AM	0	0	0	0	2	0	0	85	6	109	19	88	309
07:30 AM	0	0	0	0	0	0	0	114	3	132	17	97	363
07:45 AM	0	0	0	0	0	0	0	106	5	119	33	99	362
<b>Total</b>	<b>0</b>	<b>0</b>	<b>0</b>	<b>0</b>	<b>2</b>	<b>0</b>	<b>0</b>	<b>392</b>	<b>17</b>	<b>445</b>	<b>85</b>	<b>362</b>	<b>1303</b>
08:00 AM	0	0	0	0	0	0	0	97	4	105	29	96	331
08:15 AM	0	0	0	0	0	0	0	94	2	122	26	91	335
08:30 AM	0	0	0	0	0	2	0	92	4	127	25	72	322
08:45 AM	0	0	0	0	0	5	0	117	8	136	36	96	398
<b>Total</b>	<b>0</b>	<b>0</b>	<b>0</b>	<b>0</b>	<b>0</b>	<b>7</b>	<b>0</b>	<b>400</b>	<b>18</b>	<b>490</b>	<b>116</b>	<b>355</b>	<b>1386</b>
<b>Grand Total</b>	<b>0</b>	<b>0</b>	<b>0</b>	<b>0</b>	<b>2</b>	<b>7</b>	<b>0</b>	<b>792</b>	<b>35</b>	<b>935</b>	<b>201</b>	<b>717</b>	<b>2689</b>
Apprch %	0	0	0	0	22.2	77.8	0	95.8	4.2	50.5	10.8	38.7	
Total %	0	0	0	0	0.1	0.3	0	29.5	1.3	34.8	7.5	26.7	

Start Time	Bedford St From North				School St From East				Bedford St From South				School St From West				Int. Total	
	Left	Thru	Right	App. Total	Left	Thru	Right	App. Total	Left	Thru	Right	App. Total	Left	Thru	Right	App. Total		
<b>Peak Hour Analysis From 07:00 AM to 08:45 AM - Peak 1 of 1</b>																		
<b>Peak Hour for Entire Intersection Begins at 07:30 AM</b>																		
07:30 AM	0	0	0	0	0	0	0	0	0	0	<b>114</b>	3	<b>117</b>	<b>132</b>	17	97	246	<b>363</b>
07:45 AM	0	0	0	0	0	0	0	0	0	0	106	5	111	119	33	99	251	362
08:00 AM	0	0	0	0	0	0	0	0	0	0	97	4	101	105	29	96	230	331
08:15 AM	0	0	0	0	0	0	0	0	0	0	94	2	96	122	26	91	239	335
<b>Total Volume</b>	<b>0</b>	<b>0</b>	<b>0</b>	<b>0</b>	<b>0</b>	<b>0</b>	<b>0</b>	<b>0</b>	<b>0</b>	<b>0</b>	<b>411</b>	<b>14</b>	<b>425</b>	<b>478</b>	<b>105</b>	<b>383</b>	<b>966</b>	<b>1391</b>
<b>% App. Total</b>	<b>0</b>	<b>0</b>	<b>0</b>	<b>0</b>	<b>0</b>	<b>0</b>	<b>0</b>	<b>0</b>	<b>0</b>	<b>0</b>	<b>96.7</b>	<b>3.3</b>	<b>90.8</b>	<b>49.5</b>	<b>10.9</b>	<b>39.6</b>		
<b>PHF</b>	<b>.000</b>	<b>.000</b>	<b>.000</b>	<b>.000</b>	<b>.000</b>	<b>.000</b>	<b>.000</b>	<b>.000</b>	<b>.000</b>	<b>.000</b>	<b>.901</b>	<b>.700</b>	<b>.908</b>	<b>.905</b>	<b>.795</b>	<b>.967</b>	<b>.962</b>	<b>.958</b>

# Accurate Counts

978-664-2565

N/S Street : Bedford Street  
 E/W Street : School Street  
 City/State : Bridgewater, MA  
 Weather : Clear

File Name : 20270B12  
 Site Code : 20270012  
 Start Date : 10/2/2024  
 Page No : 5

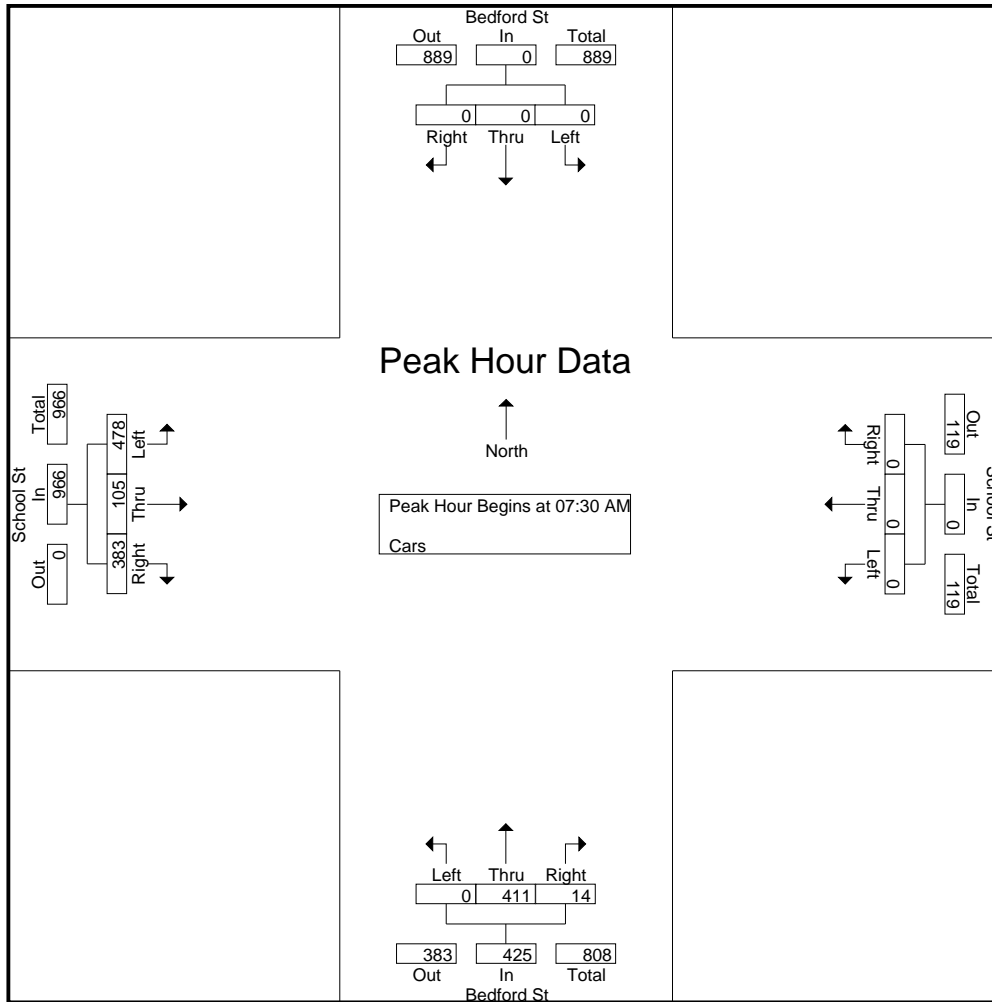

**Peak Hour Analysis From 07:00 AM to 08:45 AM - Peak 1 of 1**

Peak Hour for Each Approach Begins at:

	07:00 AM				08:00 AM				07:30 AM				07:30 AM			
+0 mins.	0	0	0	0	0	0	0	0	0	<b>114</b>	3	<b>117</b>	<b>132</b>	17	97	246
+15 mins.	0	0	0	0	0	0	0	0	0	106	<b>5</b>	111	119	<b>33</b>	<b>99</b>	<b>251</b>
+30 mins.	0	0	0	0	0	0	2	2	0	97	4	101	105	29	96	230
+45 mins.	0	0	0	0	0	0	<b>5</b>	<b>5</b>	0	94	2	96	122	26	91	239
Total Volume	0	0	0	0	0	0	7	7	0	411	14	425	478	105	383	966
% App. Total	0	0	0	0	0	0	100		0	96.7	3.3		49.5	10.9	39.6	
PHF	.000	.000	.000	.000	.000	.000	.350	.350	.000	.901	.700	.908	.905	.795	.967	.962

# Accurate Counts

978-664-2565

File Name : 20270B12

Site Code : 20270012

Start Date : 10/2/2024

Page No : 6

N/S Street : Bedford Street  
 E/W Street : School Street  
 City/State : Bridgewater, MA  
 Weather : Clear

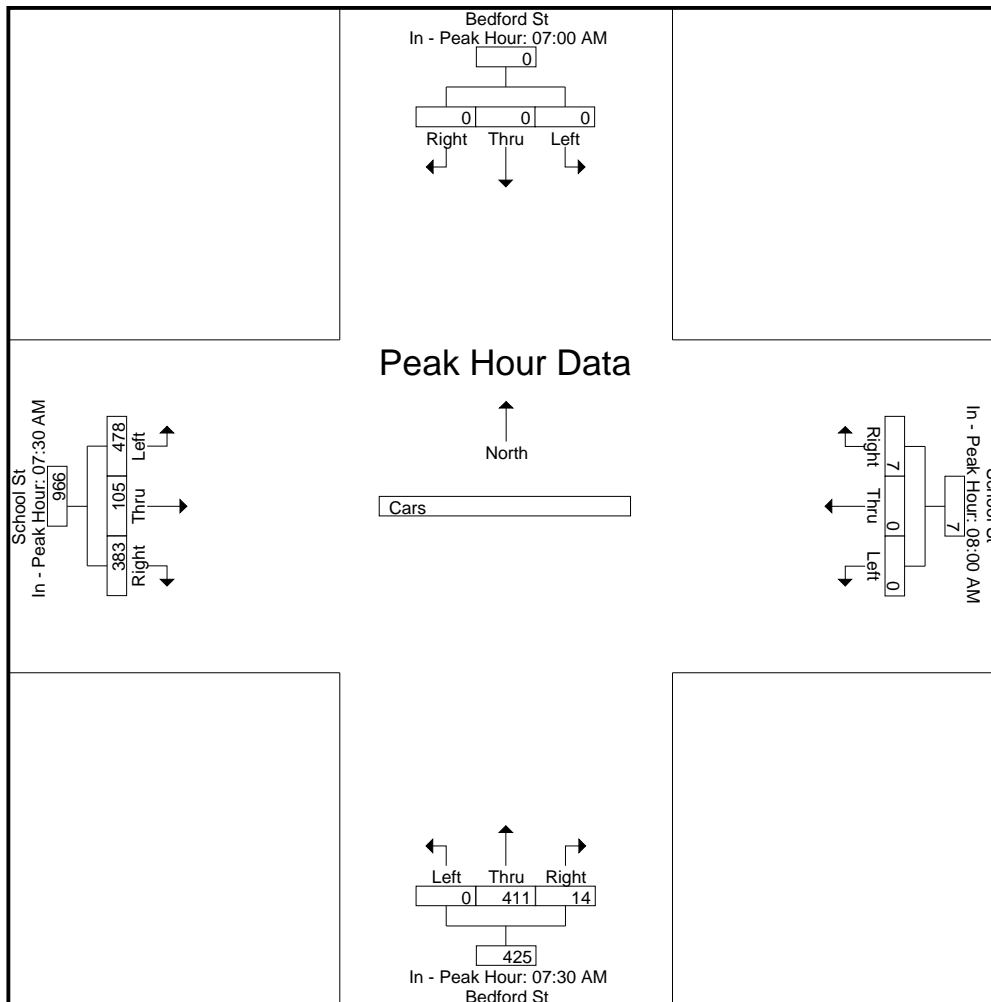

# Accurate Counts

978-664-2565

N/S Street : Bedford Street  
 E/W Street : School Street  
 City/State : Bridgewater, MA  
 Weather : Clear

File Name : 20270B12  
 Site Code : 20270012  
 Start Date : 10/2/2024  
 Page No : 7

### Groups Printed- Trucks

Start Time	Bedford St From North			School St From East			Bedford St From South			School St From West			Int. Total
	Left	Thru	Right	Left	Thru	Right	Left	Thru	Right	Left	Thru	Right	
07:00 AM	0	0	0	0	0	0	0	4	0	8	1	2	15
07:15 AM	0	0	0	0	2	0	0	2	0	4	1	6	15
07:30 AM	0	0	0	0	0	0	0	2	1	15	0	5	23
07:45 AM	0	0	0	0	0	0	0	2	0	5	4	4	15
<b>Total</b>	0	0	0	0	2	0	0	10	1	32	6	17	68
08:00 AM	0	0	0	0	0	0	0	2	0	3	1	4	10
08:15 AM	0	0	0	0	0	0	0	4	0	10	2	5	21
08:30 AM	0	0	0	0	0	0	0	3	0	14	2	6	25
08:45 AM	0	0	0	0	0	0	0	4	1	6	0	7	18
<b>Total</b>	0	0	0	0	0	0	0	13	1	33	5	22	74
<b>Grand Total</b>	0	0	0	0	2	0	0	23	2	65	11	39	142
Apprch %	0	0	0	0	100	0	0	92	8	56.5	9.6	33.9	
Total %	0	0	0	0	1.4	0	0	16.2	1.4	45.8	7.7	27.5	

Start Time	Bedford St From North				School St From East				Bedford St From South				School St From West				Int. Total	
	Left	Thru	Right	App. Total	Left	Thru	Right	App. Total	Left	Thru	Right	App. Total	Left	Thru	Right	App. Total		
<b>Peak Hour Analysis From 07:00 AM to 08:45 AM - Peak 1 of 1</b>																		
<b>Peak Hour for Entire Intersection Begins at 08:00 AM</b>																		
08:00 AM	0	0	0	0	0	0	0	0	0	0	2	0	2	3	1	4	8	10
08:15 AM	0	0	0	0	0	0	0	0	0	0	4	0	4	10	2	5	17	21
08:30 AM	0	0	0	0	0	0	0	0	0	0	3	0	3	14	2	6	22	25
08:45 AM	0	0	0	0	0	0	0	0	0	0	4	1	5	6	0	7	13	18
<b>Total Volume</b>	0	0	0	0	0	0	0	0	0	0	13	1	14	33	5	22	60	74
<b>% App. Total</b>	0	0	0	0	0	0	0	0	0	0	92.9	7.1		55	8.3	36.7		
<b>PHF</b>	.000	.000	.000	.000	.000	.000	.000	.000	.000	.000	.813	.250	.700	.589	.625	.786	.682	.740

# Accurate Counts

978-664-2565

N/S Street : Bedford Street  
 E/W Street : School Street  
 City/State : Bridgewater, MA  
 Weather : Clear

File Name : 20270B12  
 Site Code : 20270012  
 Start Date : 10/2/2024  
 Page No : 8

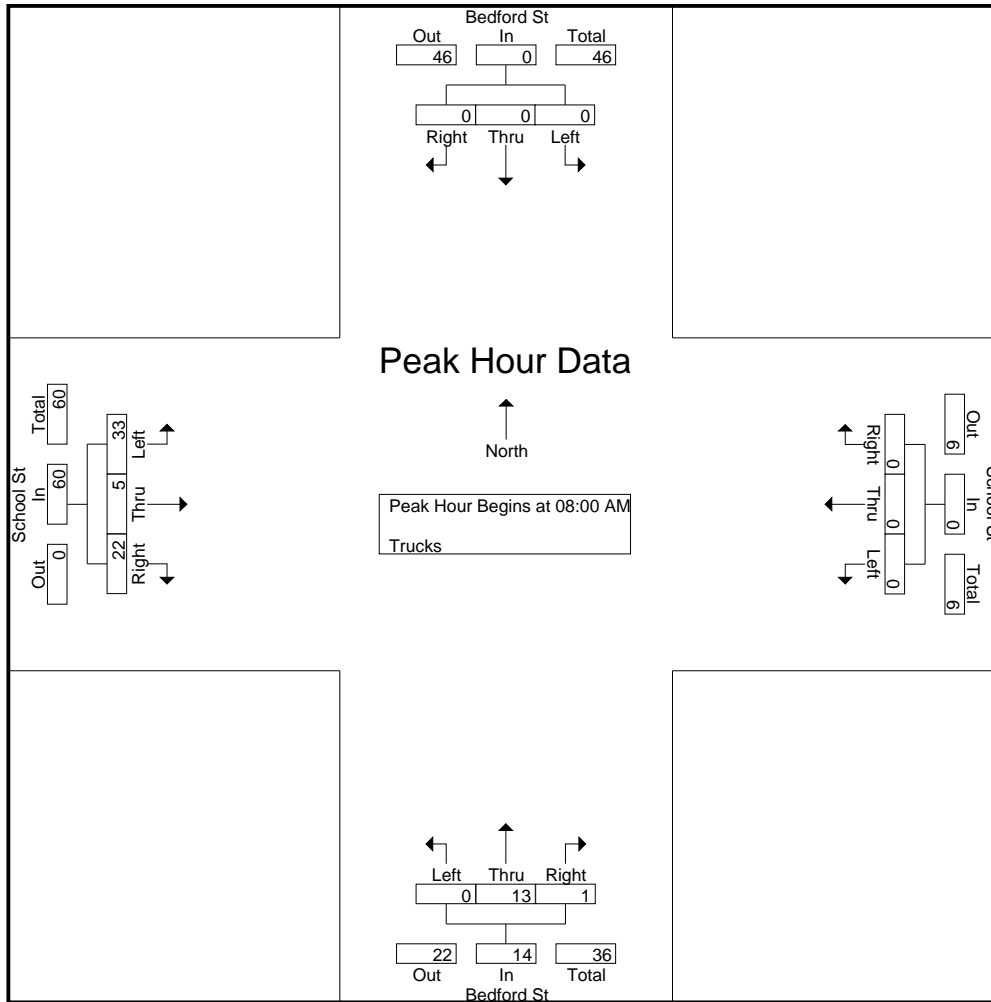

**Peak Hour Analysis From 07:00 AM to 08:45 AM - Peak 1 of 1**

Peak Hour for Each Approach Begins at:

	07:00 AM				07:00 AM				08:00 AM				07:45 AM			
+0 mins.	0	0	0	0	0	0	0	0	0	2	0	2	5	4	4	13
+15 mins.	0	0	0	0	0	2	0	2	0	4	0	4	3	1	4	8
+30 mins.	0	0	0	0	0	0	0	0	0	3	0	3	10	2	5	17
+45 mins.	0	0	0	0	0	0	0	0	0	4	1	5	14	2	6	22
Total Volume	0	0	0	0	0	2	0	2	0	13	1	14	32	9	19	60
% App. Total	0	0	0	0	0	100	0	0	0	92.9	7.1	0	53.3	15	31.7	0
PHF	.000	.000	.000	.000	.000	.250	.000	.250	.000	.813	.250	.700	.571	.563	.792	.682



# Accurate Counts

978-664-2565

File Name : 20270B12

Site Code : 20270012

Start Date : 10/2/2024

Page No : 9

N/S Street : Bedford Street

E/W Street : School Street

City/State : Bridgewater, MA

Weather : Clear

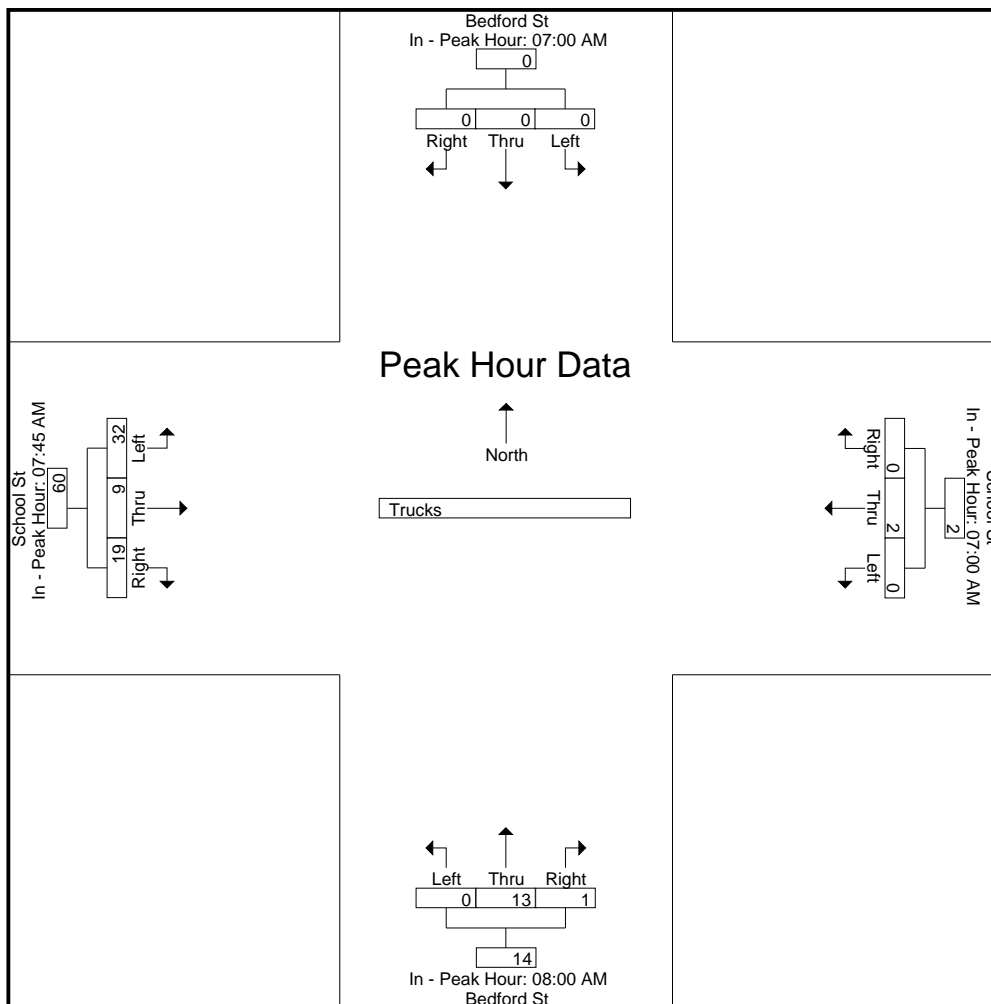

# Accurate Counts

978-664-2565

N/S Street : Bedford Street  
 E/W Street : School Street  
 City/State : Bridgewater, MA  
 Weather : Clear

File Name : 20270B12  
 Site Code : 20270012  
 Start Date : 10/2/2024  
 Page No : 10

### Groups Printed- Bikes Peds

Start Time	Bedford St From North				School St From East				Bedford St From South				School St From West				Exclu. Total	Inclu. Total	Int. Total
	Left	Thru	Right	Peds	Left	Thru	Right	Peds	Left	Thru	Right	Peds	Left	Thru	Right	Peds			
07:00 AM	0	0	0	0	0	0	0	0	0	0	0	1	0	0	0	0	1	0	1
07:15 AM	0	0	0	0	0	0	0	1	0	0	0	0	0	0	0	0	1	0	1
07:30 AM	0	0	0	0	0	0	0	0	0	0	0	0	0	0	0	0	0	0	0
07:45 AM	0	0	0	1	0	0	0	2	0	0	0	2	0	0	0	0	5	0	5
<b>Total</b>	0	0	0	1	0	0	0	3	0	0	0	3	0	0	0	0	7	0	7
08:00 AM	0	0	0	0	0	0	0	0	0	1	0	0	0	0	0	0	0	1	1
08:15 AM	0	0	0	0	0	0	0	0	0	0	0	0	0	0	0	0	0	0	0
08:30 AM	0	0	0	0	0	0	0	1	0	0	0	0	0	0	0	0	1	0	1
08:45 AM	0	0	0	0	0	0	0	3	0	0	0	6	0	0	0	0	9	0	9
<b>Total</b>	0	0	0	0	0	0	0	4	0	1	0	6	0	0	0	0	10	1	11
<b>Grand Total</b>	0	0	0	1	0	0	0	7	0	1	0	9	0	0	0	0	17	1	18
Apprch %	0	0	0		0	0	0		0	100	0		0	0	0				
Total %	0	0	0		0	0	0		0	100	0		0	0	0		94.4	5.6	

Start Time	Bedford St From North				School St From East				Bedford St From South				School St From West				Int. Total
	Left	Thru	Right	App. Total	Left	Thru	Right	App. Total	Left	Thru	Right	App. Total	Left	Thru	Right	App. Total	
Peak Hour Analysis From 07:00 AM to 08:45 AM - Peak 1 of 1																	
Peak Hour for Entire Intersection Begins at 07:15 AM																	
07:15 AM	0	0	0	0	0	0	0	0	0	0	0	0	0	0	0	0	0
07:30 AM	0	0	0	0	0	0	0	0	0	0	0	0	0	0	0	0	0
07:45 AM	0	0	0	0	0	0	0	0	0	0	0	0	0	0	0	0	0
08:00 AM	0	0	0	0	0	0	0	0	0	1	0	1	0	0	0	0	1
<b>Total Volume</b>	0	0	0	0	0	0	0	0	0	1	0	1	0	0	0	0	1
<b>% App. Total</b>	0	0	0		0	0	0		0	100	0		0	0	0		
PHF	.000	.000	.000	.000	.000	.000	.000	.000	.000	.250	.000	.250	.000	.000	.000	.000	.250

# Accurate Counts

978-664-2565

N/S Street : Bedford Street  
 E/W Street : School Street  
 City/State : Bridgewater, MA  
 Weather : Clear

File Name : 20270B12  
 Site Code : 20270012  
 Start Date : 10/2/2024  
 Page No : 11

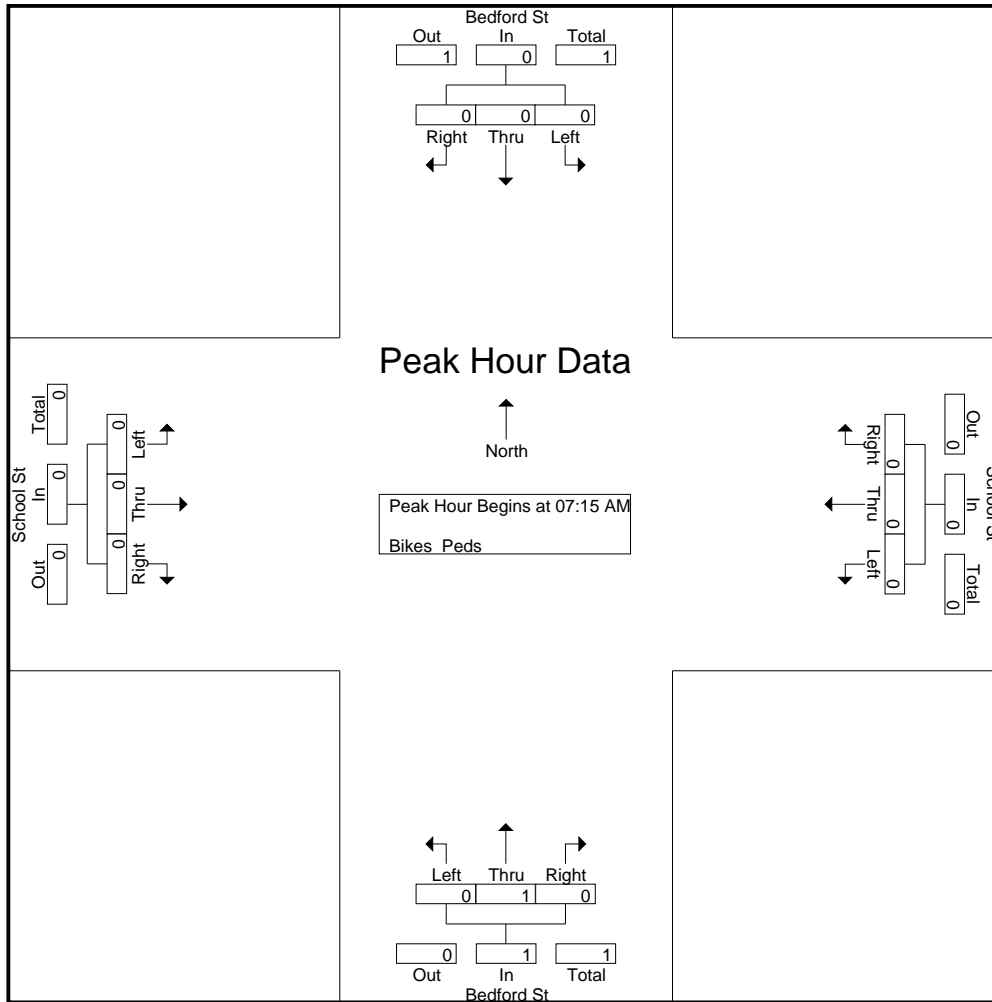

**Peak Hour Analysis From 07:00 AM to 08:45 AM - Peak 1 of 1**

Peak Hour for Each Approach Begins at:

	07:00 AM				07:00 AM				07:15 AM				07:00 AM			
+0 mins.	0	0	0	0	0	0	0	0	0	0	0	0	0	0	0	0
+15 mins.	0	0	0	0	0	0	0	0	0	0	0	0	0	0	0	0
+30 mins.	0	0	0	0	0	0	0	0	0	0	0	0	0	0	0	0
+45 mins.	0	0	0	0	0	0	0	0	0	1	0	1	0	0	0	0
Total Volume	0	0	0	0	0	0	0	0	0	1	0	1	0	0	0	0
% App. Total	0	0	0	0	0	0	0	0	0	100	0	100	0	0	0	0
PHF	.000	.000	.000	.000	.000	.000	.000	.000	.000	.250	.000	.250	.000	.000	.000	.000

# Accurate Counts

978-664-2565

N/S Street : Bedford Street  
E/W Street : School Street  
City/State : Bridgewater, MA  
Weather : Clear

File Name : 20270B12  
Site Code : 20270012  
Start Date : 10/2/2024  
Page No : 12

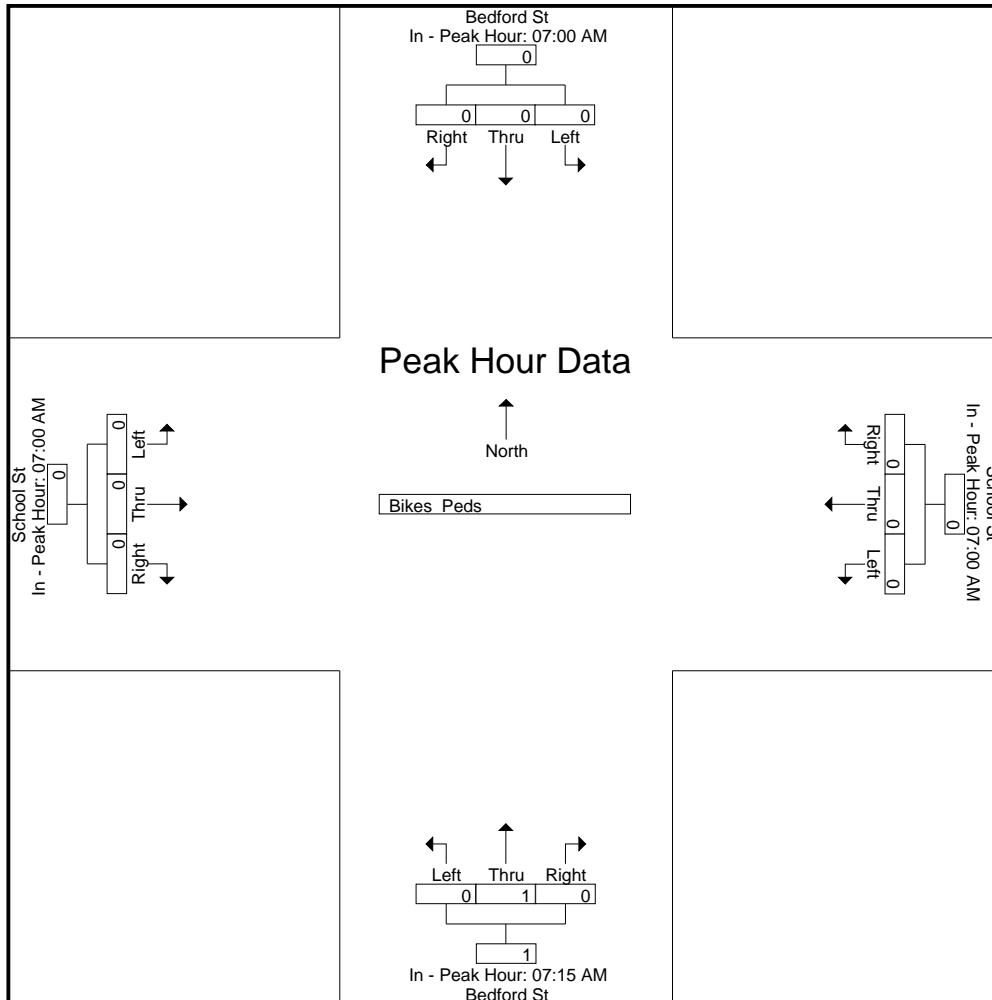

# Accurate Counts

978-664-2565

N/S Street : Bedford Street  
 E/W Street : School Street  
 City/State : Bridgewater, MA  
 Weather : Clear

File Name : 20270B12  
 Site Code : 20270012  
 Start Date : 10/2/2024  
 Page No : 1

### Groups Printed- Cars - Trucks

Start Time	Bedford St From North			School St From East			Bedford St From South			School St From West			Int. Total
	Left	Thru	Right	Left	Thru	Right	Left	Thru	Right	Left	Thru	Right	
04:00 PM	0	0	0	0	0	2	0	119	5	135	29	114	404
04:15 PM	0	0	0	0	0	2	0	108	3	141	41	98	393
04:30 PM	0	0	0	0	0	2	0	118	3	137	37	122	419
04:45 PM	0	0	0	0	0	6	0	124	3	134	23	110	400
<b>Total</b>	<b>0</b>	<b>0</b>	<b>0</b>	<b>0</b>	<b>0</b>	<b>12</b>	<b>0</b>	<b>469</b>	<b>14</b>	<b>547</b>	<b>130</b>	<b>444</b>	<b>1616</b>
05:00 PM	0	0	0	0	0	5	0	89	3	136	35	129	397
05:15 PM	0	0	0	0	0	5	0	110	3	130	41	129	418
05:30 PM	0	0	0	0	0	1	0	94	0	142	28	108	373
05:45 PM	0	0	0	0	0	2	0	78	1	147	45	95	368
<b>Total</b>	<b>0</b>	<b>0</b>	<b>0</b>	<b>0</b>	<b>0</b>	<b>13</b>	<b>0</b>	<b>371</b>	<b>7</b>	<b>555</b>	<b>149</b>	<b>461</b>	<b>1556</b>
<b>Grand Total</b>	<b>0</b>	<b>0</b>	<b>0</b>	<b>0</b>	<b>0</b>	<b>25</b>	<b>0</b>	<b>840</b>	<b>21</b>	<b>1102</b>	<b>279</b>	<b>905</b>	<b>3172</b>
Apprch %	0	0	0	0	0	100	0	97.6	2.4	48.2	12.2	39.6	
Total %	0	0	0	0	0	0.8	0	26.5	0.7	34.7	8.8	28.5	
Cars	0	0	0	0	0	25	0	820	20	1081	277	891	3114
% Cars	0	0	0	0	0	100	0	97.6	95.2	98.1	99.3	98.5	98.2
Trucks	0	0	0	0	0	0	0	20	1	21	2	14	58
% Trucks	0	0	0	0	0	0	0	2.4	4.8	1.9	0.7	1.5	1.8

Start Time	Bedford St From North				School St From East				Bedford St From South				School St From West				Int. Total
	Left	Thru	Right	App. Total	Left	Thru	Right	App. Total	Left	Thru	Right	App. Total	Left	Thru	Right	App. Total	
Peak Hour Analysis From 04:00 PM to 05:45 PM - Peak 1 of 1																	
Peak Hour for Entire Intersection Begins at 04:30 PM																	
04:30 PM	0	0	0	0	0	0	2	2	0	118	3	121	137	37	122	296	419
04:45 PM	0	0	0	0	0	0	6	6	0	124	3	127	134	23	110	267	400
05:00 PM	0	0	0	0	0	0	5	5	0	89	3	92	136	35	129	300	397
05:15 PM	0	0	0	0	0	0	5	5	0	110	3	113	130	41	129	300	418
<b>Total Volume</b>	<b>0</b>	<b>0</b>	<b>0</b>	<b>0</b>	<b>0</b>	<b>0</b>	<b>18</b>	<b>18</b>	<b>0</b>	<b>441</b>	<b>12</b>	<b>453</b>	<b>537</b>	<b>136</b>	<b>490</b>	<b>1163</b>	<b>1634</b>
<b>% App. Total</b>	<b>0</b>	<b>0</b>	<b>0</b>	<b>0</b>	<b>0</b>	<b>0</b>	<b>100</b>	<b>100</b>	<b>0</b>	<b>97.4</b>	<b>2.6</b>	<b>97.6</b>	<b>46.2</b>	<b>11.7</b>	<b>42.1</b>	<b>46.2</b>	<b>97.9</b>
PHF	.000	.000	.000	.000	.000	.000	.750	.750	.000	.889	1.00	.892	.980	.829	.950	.969	.975
Cars	0	0	0	0	0	0	18	18	0	430	12	442	524	135	481	1140	1600
% Cars	0	0	0	0	0	0	100	100	0	97.5	100	97.6	97.6	99.3	98.2	98.0	97.9
Trucks	0	0	0	0	0	0	0	0	0	11	0	11	13	1	9	23	34
% Trucks	0	0	0	0	0	0	0	0	0	2.5	0	2.4	2.4	0.7	1.8	2.0	2.1

# Accurate Counts

978-664-2565

N/S Street : Bedford Street  
 E/W Street : School Street  
 City/State : Bridgewater, MA  
 Weather : Clear

File Name : 20270B12  
 Site Code : 20270012  
 Start Date : 10/2/2024  
 Page No : 2

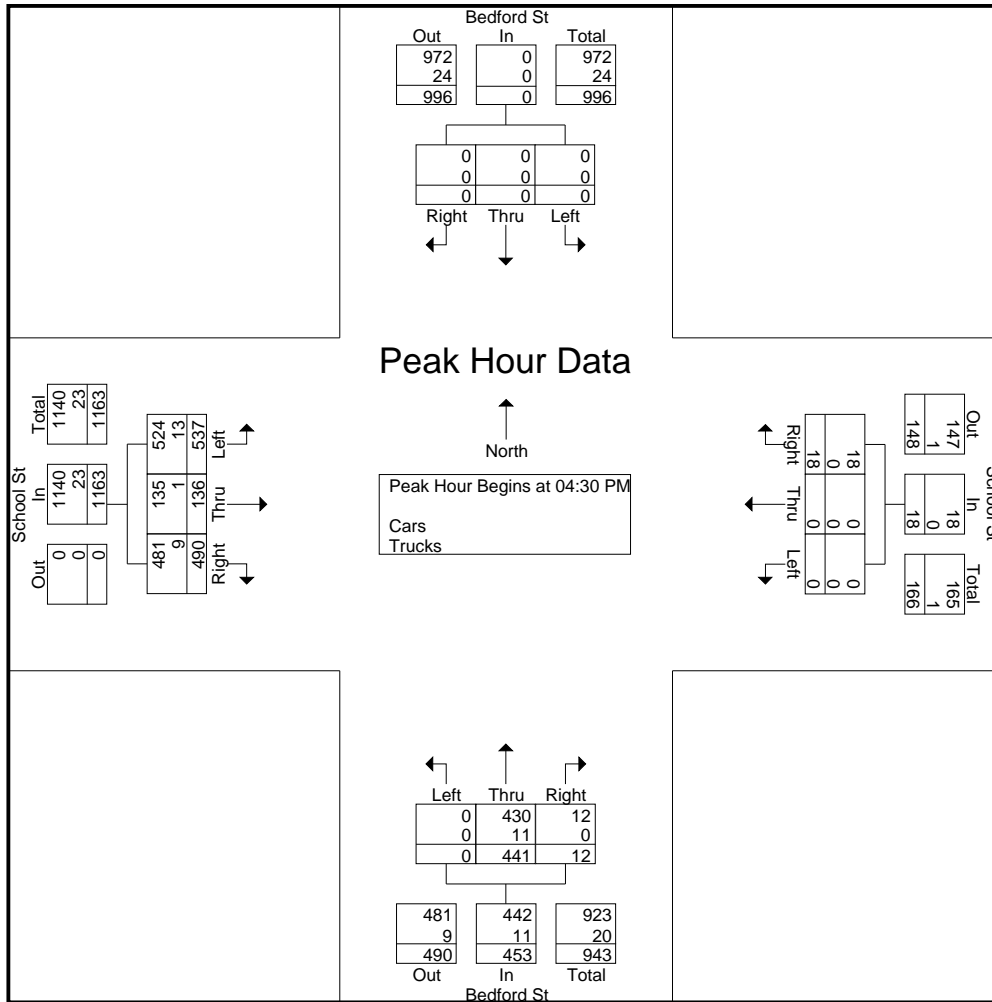

**Peak Hour Analysis From 04:00 PM to 05:45 PM - Peak 1 of 1**

Peak Hour for Each Approach Begins at:

	04:00 PM				04:30 PM				04:00 PM				05:00 PM			
+0 mins.	0	0	0	0	0	0	2	2	0	119	5	124	136	35	129	300
+15 mins.	0	0	0	0	0	0	6	6	0	108	3	111	130	41	129	300
+30 mins.	0	0	0	0	0	0	5	5	0	118	3	121	142	28	108	278
+45 mins.	0	0	0	0	0	0	5	5	0	124	3	127	147	45	95	287
Total Volume	0	0	0	0	0	0	18	18	0	469	14	483	555	149	461	1165
% App. Total	0	0	0	0	0	0	100	100	0	97.1	2.9	96.9	47.6	12.8	39.6	98.7
PHF	.000	.000	.000	.000	.000	.000	.750	.750	.000	.946	.700	.951	.944	.828	.893	.971
Cars	0	0	0	0	0	0	18	18	0	455	13	468	548	149	455	1152
% Cars	0	0	0	0	0	0	100	100	0	97	92.9	96.9	98.7	100	98.7	98.9
Trucks	0	0	0	0	0	0	0	0	0	14	1	15	7	0	6	13
% Trucks	0	0	0	0	0	0	0	0	0	3	7.1	3.1	1.3	0	1.3	1.1

# Accurate Counts

978-664-2565

N/S Street : Bedford Street  
 E/W Street : School Street  
 City/State : Bridgewater, MA  
 Weather : Clear

File Name : 20270B12  
 Site Code : 20270012  
 Start Date : 10/2/2024  
 Page No : 3

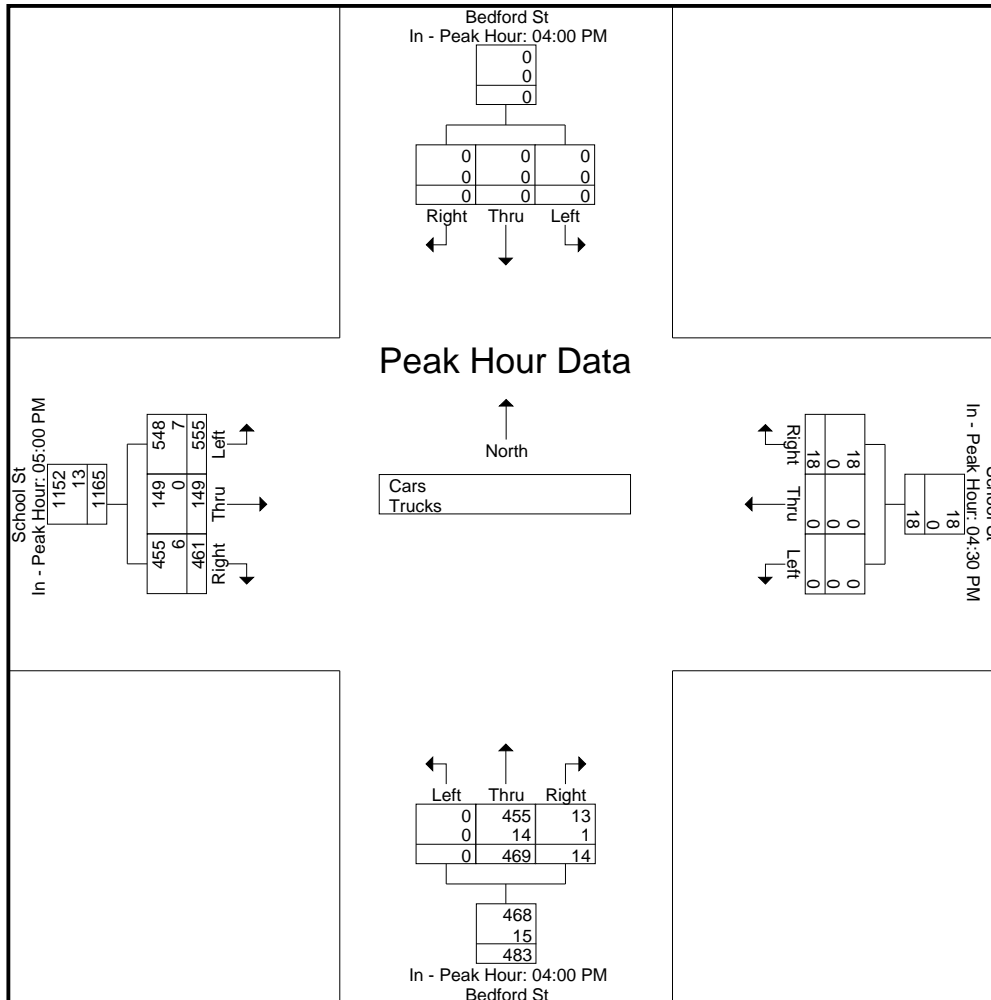

# Accurate Counts

978-664-2565

N/S Street : Bedford Street  
 E/W Street : School Street  
 City/State : Bridgewater, MA  
 Weather : Clear

File Name : 20270B12  
 Site Code : 20270012  
 Start Date : 10/2/2024  
 Page No : 4

## Groups Printed- Cars

Start Time	Bedford St From North			School St From East			Bedford St From South			School St From West			Int. Total
	Left	Thru	Right	Left	Thru	Right	Left	Thru	Right	Left	Thru	Right	
04:00 PM	0	0	0	0	0	2	0	116	5	132	28	112	395
04:15 PM	0	0	0	0	0	2	0	104	2	138	41	97	384
04:30 PM	0	0	0	0	0	2	0	118	3	131	36	119	409
04:45 PM	0	0	0	0	0	6	0	117	3	132	23	108	389
<b>Total</b>	<b>0</b>	<b>0</b>	<b>0</b>	<b>0</b>	<b>0</b>	<b>12</b>	<b>0</b>	<b>455</b>	<b>13</b>	<b>533</b>	<b>128</b>	<b>436</b>	<b>1577</b>
05:00 PM	0	0	0	0	0	5	0	88	3	134	35	127	392
05:15 PM	0	0	0	0	0	5	0	107	3	127	41	127	410
05:30 PM	0	0	0	0	0	1	0	94	0	140	28	107	370
05:45 PM	0	0	0	0	0	2	0	76	1	147	45	94	365
<b>Total</b>	<b>0</b>	<b>0</b>	<b>0</b>	<b>0</b>	<b>0</b>	<b>13</b>	<b>0</b>	<b>365</b>	<b>7</b>	<b>548</b>	<b>149</b>	<b>455</b>	<b>1537</b>
<b>Grand Total</b>	<b>0</b>	<b>0</b>	<b>0</b>	<b>0</b>	<b>0</b>	<b>25</b>	<b>0</b>	<b>820</b>	<b>20</b>	<b>1081</b>	<b>277</b>	<b>891</b>	<b>3114</b>
Apprch %	0	0	0	0	0	100	0	97.6	2.4	48.1	12.3	39.6	
Total %	0	0	0	0	0	0.8	0	26.3	0.6	34.7	8.9	28.6	

Start Time	Bedford St From North				School St From East				Bedford St From South				School St From West				Int. Total
	Left	Thru	Right	App. Total	Left	Thru	Right	App. Total	Left	Thru	Right	App. Total	Left	Thru	Right	App. Total	
<b>Peak Hour Analysis From 04:00 PM to 05:45 PM - Peak 1 of 1</b>																	
<b>Peak Hour for Entire Intersection Begins at 04:30 PM</b>																	
04:30 PM	0	0	0	0	0	0	2	2	0	<b>118</b>	<b>3</b>	<b>121</b>	131	36	119	286	409
04:45 PM	0	0	0	0	0	0	<b>6</b>	<b>6</b>	0	117	3	120	132	23	108	263	389
05:00 PM	0	0	0	0	0	0	5	5	0	88	3	91	<b>134</b>	35	<b>127</b>	<b>296</b>	392
05:15 PM	0	0	0	0	0	0	5	5	0	107	3	110	127	<b>41</b>	127	295	<b>410</b>
<b>Total Volume</b>	0	0	0	0	0	0	18	18	0	430	12	442	524	135	481	1140	1600
<b>% App. Total</b>	0	0	0	0	0	0	100		0	97.3	2.7		46	11.8	42.2		
PHF	.000	.000	.000	.000	.000	.000	.750	.750	.000	.911	1.00	.913	.978	.823	.947	.963	.976



# Accurate Counts

978-664-2565

N/S Street : Bedford Street  
 E/W Street : School Street  
 City/State : Bridgewater, MA  
 Weather : Clear

File Name : 20270B12  
 Site Code : 20270012  
 Start Date : 10/2/2024  
 Page No : 5

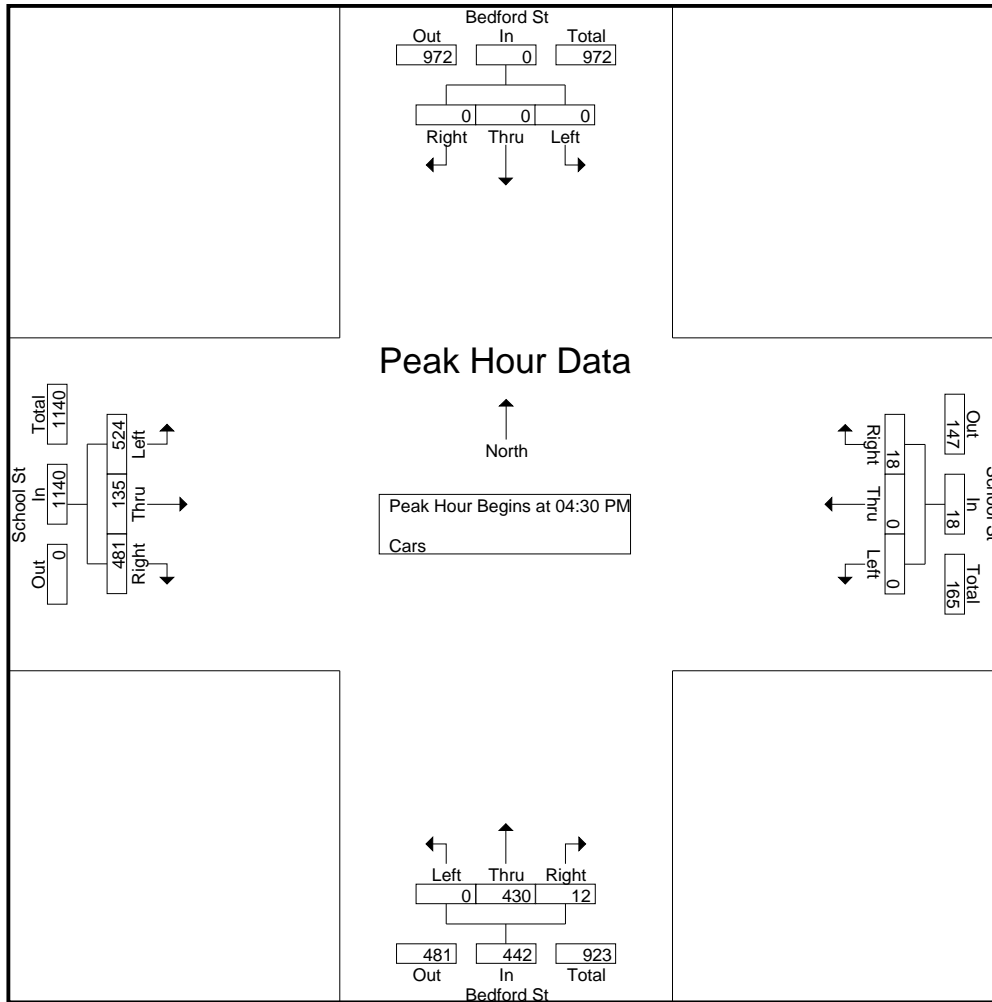

**Peak Hour Analysis From 04:00 PM to 05:45 PM - Peak 1 of 1**

Peak Hour for Each Approach Begins at:

	04:00 PM				04:30 PM				05:00 PM							
+0 mins.	0	0	0	0	0	0	2	2	0	116	5	121	134	35	127	296
+15 mins.	0	0	0	0	0	0	6	6	0	104	2	106	127	41	127	295
+30 mins.	0	0	0	0	0	0	5	5	0	118	3	121	140	28	107	275
+45 mins.	0	0	0	0	0	0	5	5	0	117	3	120	147	45	94	286
Total Volume	0	0	0	0	0	0	18	18	0	455	13	468	548	149	455	1152
% App. Total	0	0	0	0	0	0	100	100	0	97.2	2.8	97.2	47.6	12.9	39.5	97.2
PHF	.000	.000	.000	.000	.000	.000	.750	.750	.000	.964	.650	.967	.932	.828	.896	.973

# Accurate Counts

978-664-2565

File Name : 20270B12

Site Code : 20270012

Start Date : 10/2/2024

Page No : 6

N/S Street : Bedford Street

E/W Street : School Street

City/State : Bridgewater, MA

Weather : Clear

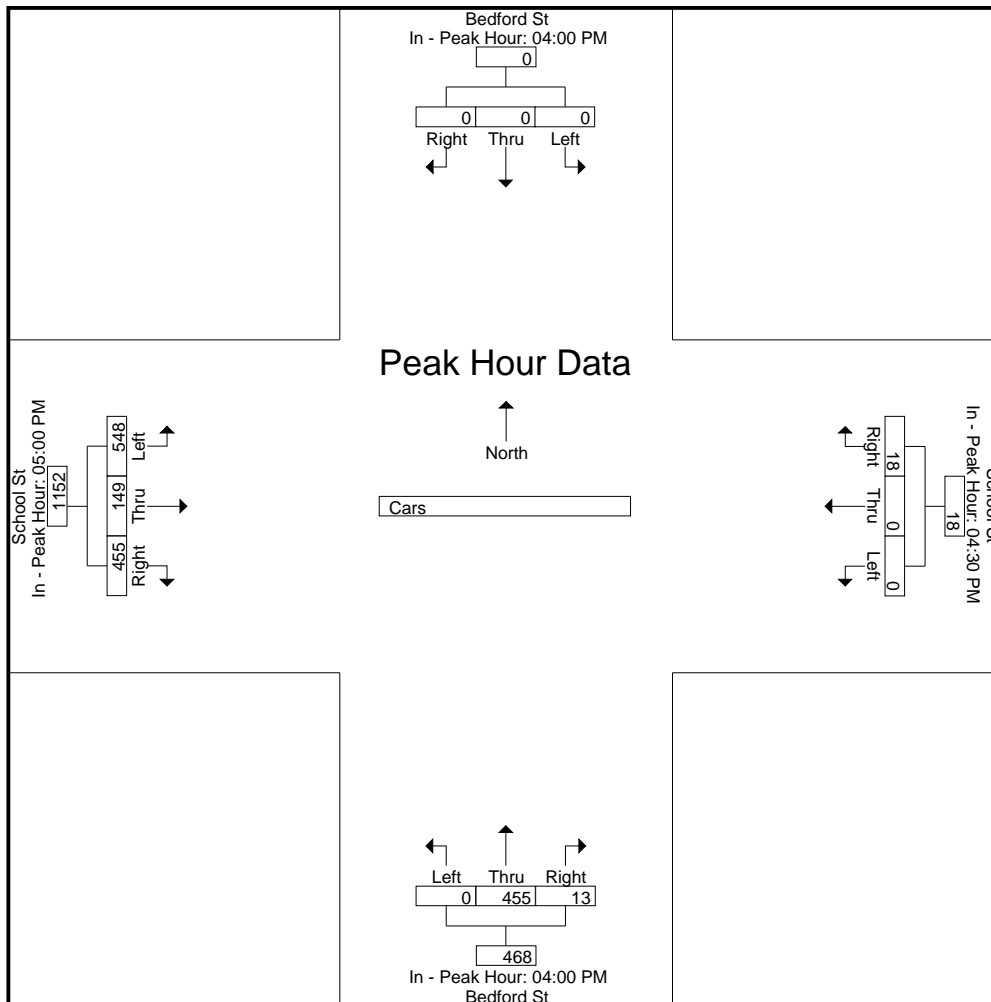

# Accurate Counts

978-664-2565

N/S Street : Bedford Street  
 E/W Street : School Street  
 City/State : Bridgewater, MA  
 Weather : Clear

File Name : 20270B12  
 Site Code : 20270012  
 Start Date : 10/2/2024  
 Page No : 7

### Groups Printed- Trucks

Start Time	Bedford St From North			School St From East			Bedford St From South			School St From West			Int. Total
	Left	Thru	Right	Left	Thru	Right	Left	Thru	Right	Left	Thru	Right	
04:00 PM	0	0	0	0	0	0	0	3	0	3	1	2	9
04:15 PM	0	0	0	0	0	0	0	4	1	3	0	1	9
04:30 PM	0	0	0	0	0	0	0	0	0	6	1	3	10
04:45 PM	0	0	0	0	0	0	0	7	0	2	0	2	11
<b>Total</b>	0	0	0	0	0	0	0	14	1	14	2	8	39
05:00 PM	0	0	0	0	0	0	0	1	0	2	0	2	5
05:15 PM	0	0	0	0	0	0	0	3	0	3	0	2	8
05:30 PM	0	0	0	0	0	0	0	0	0	2	0	1	3
05:45 PM	0	0	0	0	0	0	0	2	0	0	0	1	3
<b>Total</b>	0	0	0	0	0	0	0	6	0	7	0	6	19
<b>Grand Total</b>	0	0	0	0	0	0	0	20	1	21	2	14	58
Apprch %	0	0	0	0	0	0	0	95.2	4.8	56.8	5.4	37.8	
Total %	0	0	0	0	0	0	0	34.5	1.7	36.2	3.4	24.1	

Start Time	Bedford St From North				School St From East				Bedford St From South				School St From West				Int. Total	
	Left	Thru	Right	App. Total	Left	Thru	Right	App. Total	Left	Thru	Right	App. Total	Left	Thru	Right	App. Total		
<b>Peak Hour Analysis From 04:00 PM to 05:45 PM - Peak 1 of 1</b>																		
<b>Peak Hour for Entire Intersection Begins at 04:00 PM</b>																		
04:00 PM	0	0	0	0	0	0	0	0	0	0	3	0	3	3	1	2	6	9
04:15 PM	0	0	0	0	0	0	0	0	0	0	4	1	5	3	0	1	4	9
04:30 PM	0	0	0	0	0	0	0	0	0	0	0	0	0	6	1	3	10	10
04:45 PM	0	0	0	0	0	0	0	0	0	0	7	0	7	2	0	2	4	11
<b>Total Volume</b>	0	0	0	0	0	0	0	0	0	0	14	1	15	14	2	8	24	39
<b>% App. Total</b>	0	0	0	0	0	0	0	0	0	0	93.3	6.7		58.3	8.3	33.3		
<b>PHF</b>	.000	.000	.000	.000	.000	.000	.000	.000	.000	.000	.500	.250	.536	.583	.500	.667	.600	.886

# Accurate Counts

978-664-2565

N/S Street : Bedford Street  
 E/W Street : School Street  
 City/State : Bridgewater, MA  
 Weather : Clear

File Name : 20270B12  
 Site Code : 20270012  
 Start Date : 10/2/2024  
 Page No : 8

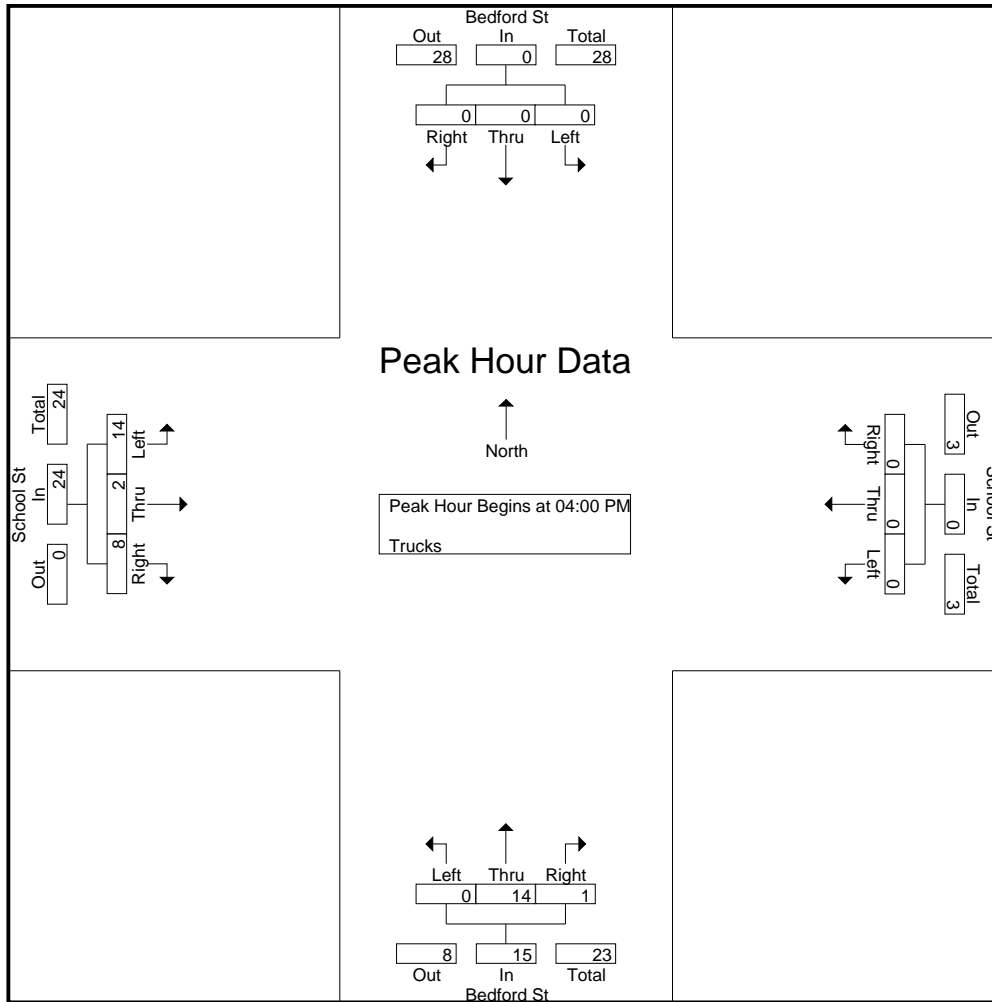

**Peak Hour Analysis From 04:00 PM to 05:45 PM - Peak 1 of 1**

Peak Hour for Each Approach Begins at:

	04:00 PM				04:00 PM				04:00 PM				04:00 PM			
+0 mins.	0	0	0	0	0	0	0	0	0	3	0	3	3	1	2	6
+15 mins.	0	0	0	0	0	0	0	0	0	4	1	5	3	0	1	4
+30 mins.	0	0	0	0	0	0	0	0	0	0	0	0	6	1	3	10
+45 mins.	0	0	0	0	0	0	0	0	0	7	0	7	2	0	2	4
Total Volume	0	0	0	0	0	0	0	0	0	14	1	15	14	2	8	24
% App. Total	0	0	0	0	0	0	0	0	0	93.3	6.7		58.3	8.3	33.3	
PHF	.000	.000	.000	.000	.000	.000	.000	.000	.000	.500	.250	.536	.583	.500	.667	.600

# Accurate Counts

978-664-2565

N/S Street : Bedford Street  
E/W Street : School Street  
City/State : Bridgewater, MA  
Weather : Clear

File Name : 20270B12  
Site Code : 20270012  
Start Date : 10/2/2024  
Page No : 9

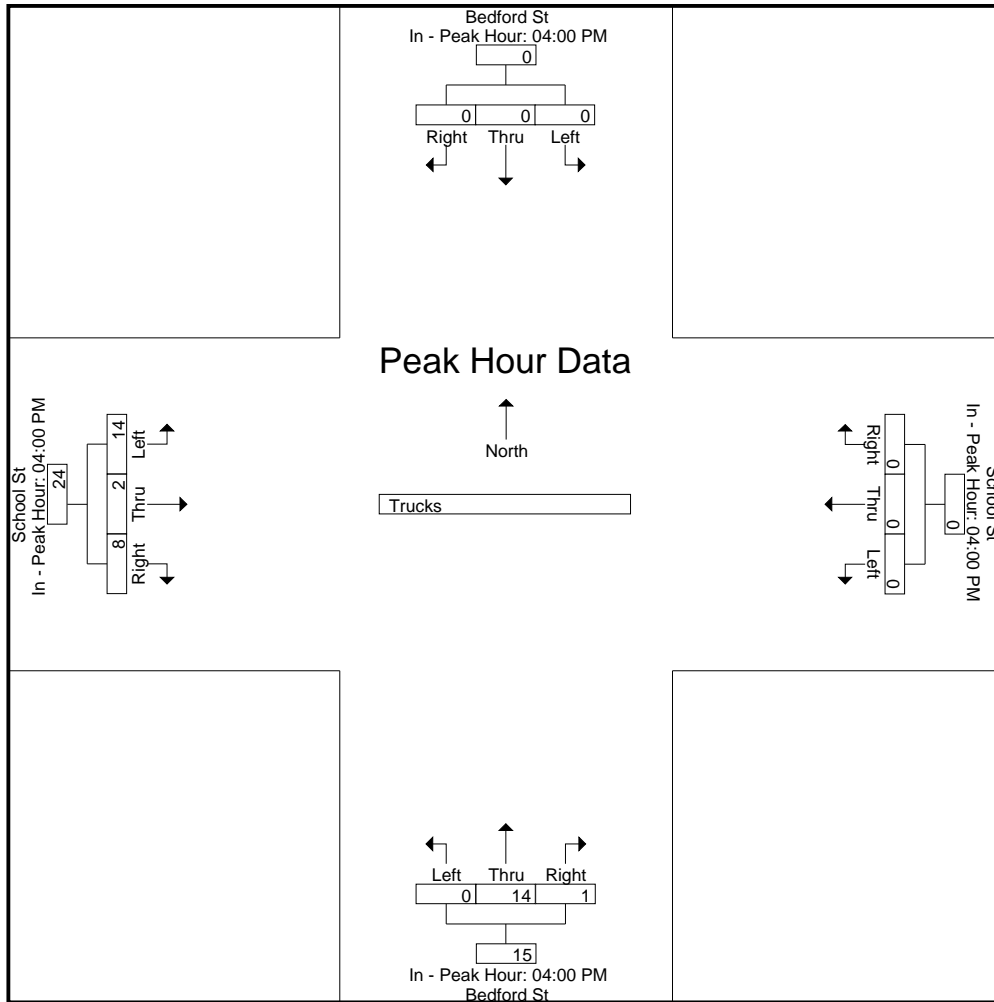

# Accurate Counts

978-664-2565

N/S Street : Bedford Street  
 E/W Street : School Street  
 City/State : Bridgewater, MA  
 Weather : Clear

File Name : 20270B12  
 Site Code : 20270012  
 Start Date : 10/2/2024  
 Page No : 10

### Groups Printed- Bikes Peds

Start Time	Bedford St From North				School St From East				Bedford St From South				School St From West				Exclu. Total	Inclu. Total	Int. Total
	Left	Thru	Right	Peds	Left	Thru	Right	Peds	Left	Thru	Right	Peds	Left	Thru	Right	Peds			
04:00 PM	0	0	0	0	0	0	0	6	0	0	0	9	0	0	0	0	15	0	15
04:15 PM	0	0	0	0	0	0	0	6	0	0	0	6	0	0	0	0	12	0	12
04:30 PM	0	0	0	0	0	0	0	1	0	0	0	2	0	1	0	0	3	1	4
04:45 PM	0	0	0	0	0	0	0	4	0	0	1	3	0	0	0	0	7	1	8
<b>Total</b>	0	0	0	0	0	0	0	17	0	0	1	20	0	1	0	0	37	2	39
05:00 PM	0	0	0	1	0	0	0	2	0	0	0	5	0	0	0	0	8	0	8
05:15 PM	0	0	0	0	0	0	0	3	0	0	0	2	0	0	0	0	5	0	5
05:30 PM	0	0	0	0	0	0	0	0	0	0	0	1	0	0	0	0	1	0	1
05:45 PM	0	0	0	0	0	0	0	1	0	0	0	0	0	0	0	0	1	0	1
<b>Total</b>	0	0	0	1	0	0	0	6	0	0	0	8	0	0	0	0	15	0	15
<b>Grand Total</b>	0	0	0	1	0	0	0	23	0	0	1	28	0	1	0	0	52	2	54
Apprch %	0	0	0		0	0	0		0	0	100		0	100	0				
Total %	0	0	0		0	0	0		0	0	50		0	50	0		96.3	3.7	

Start Time	Bedford St From North				School St From East				Bedford St From South				School St From West				Int. Total
	Left	Thru	Right	App. Total	Left	Thru	Right	App. Total	Left	Thru	Right	App. Total	Left	Thru	Right	App. Total	
<b>Peak Hour Analysis From 04:00 PM to 05:45 PM - Peak 1 of 1</b>																	
<b>Peak Hour for Entire Intersection Begins at 04:00 PM</b>																	
04:00 PM	0	0	0	0	0	0	0	0	0	0	0	0	0	0	0	0	0
04:15 PM	0	0	0	0	0	0	0	0	0	0	0	0	0	0	0	0	0
04:30 PM	0	0	0	0	0	0	0	0	0	0	0	0	0	1	0	1	1
04:45 PM	0	0	0	0	0	0	0	0	0	0	1	1	0	0	0	0	1
<b>Total Volume</b>	0	0	0	0	0	0	0	0	0	0	1	1	0	1	0	1	2
<b>% App. Total</b>	0	0	0		0	0	0		0	0	100		0	100	0		
<b>PHF</b>	.000	.000	.000	.000	.000	.000	.000	.000	.000	.000	.250	.250	.000	.250	.000	.250	.500

# Accurate Counts

978-664-2565

N/S Street : Bedford Street  
 E/W Street : School Street  
 City/State : Bridgewater, MA  
 Weather : Clear

File Name : 20270B12  
 Site Code : 20270012  
 Start Date : 10/2/2024  
 Page No : 11

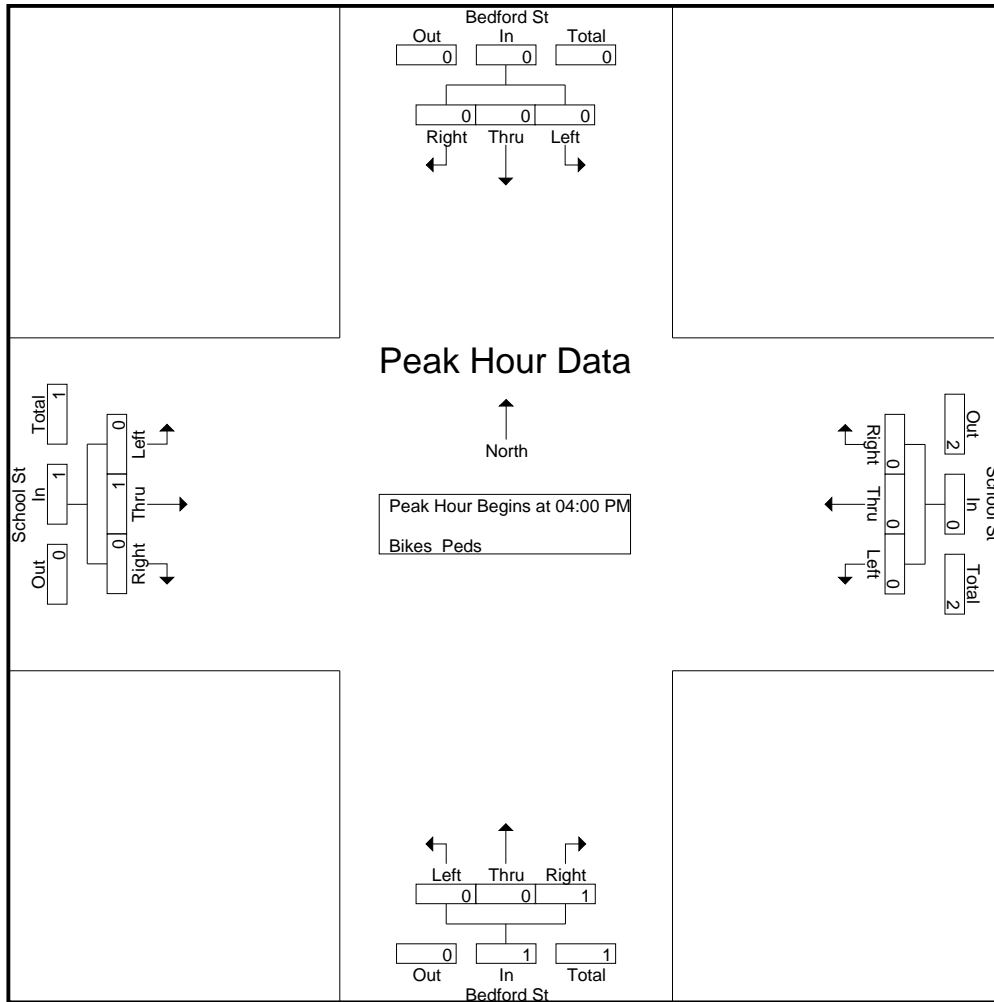

**Peak Hour Analysis From 04:00 PM to 05:45 PM - Peak 1 of 1**

**Peak Hour for Each Approach Begins at:**

	04:00 PM				04:00 PM				04:00 PM				04:00 PM			
+0 mins.	0	0	0	0	0	0	0	0	0	0	0	0	0	0	0	0
+15 mins.	0	0	0	0	0	0	0	0	0	0	0	0	0	0	0	0
+30 mins.	0	0	0	0	0	0	0	0	0	0	0	0	0	1	0	1
+45 mins.	0	0	0	0	0	0	0	0	0	0	1	1	0	0	0	0
Total Volume	0	0	0	0	0	0	0	0	0	0	1	1	0	1	0	1
% App. Total	0	0	0	0	0	0	0	0	0	0	100	100	0	100	0	0
PHF	.000	.000	.000	.000	.000	.000	.000	.000	.000	.000	.250	.250	.000	.250	.000	.250

# Accurate Counts

978-664-2565

File Name : 20270B12

Site Code : 20270012

Start Date : 10/2/2024

Page No : 12

N/S Street : Bedford Street  
 E/W Street : School Street  
 City/State : Bridgewater, MA  
 Weather : Clear

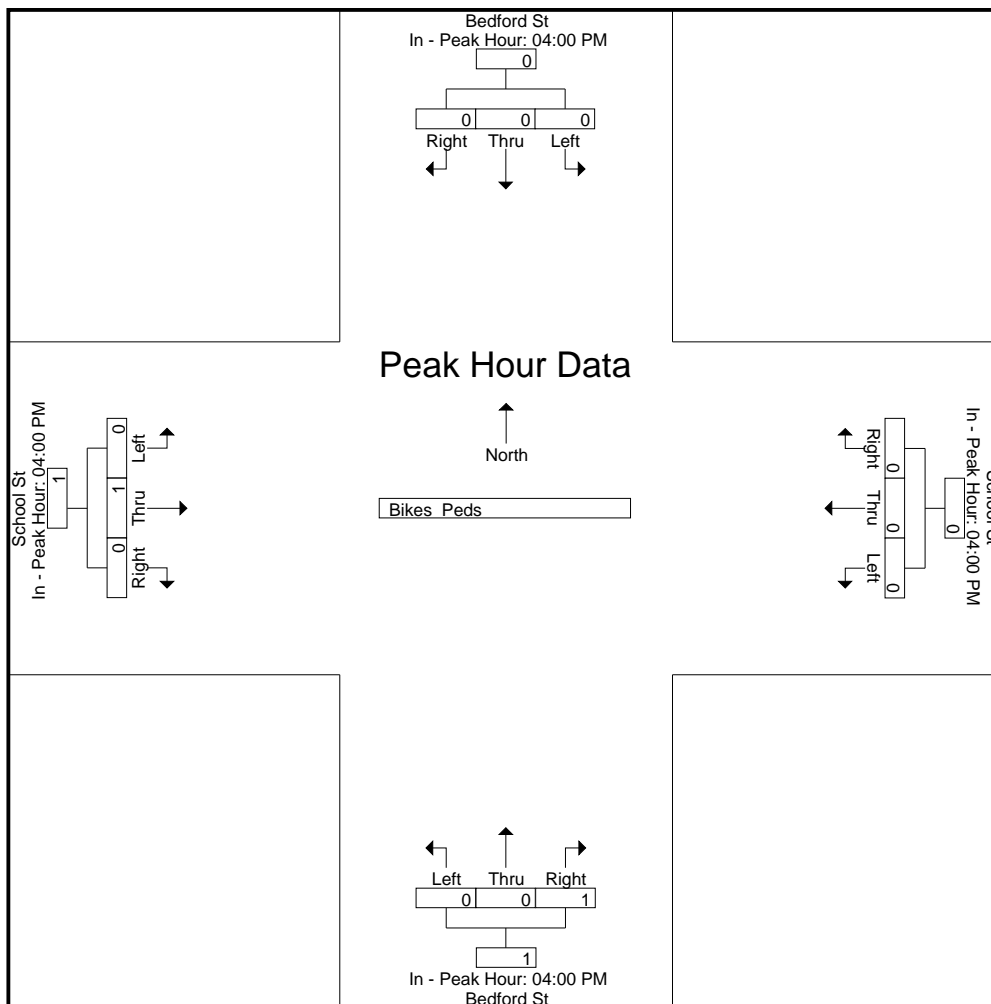



# Accurate Counts

978-664-2565

N/S Street : Broad St / Central Square

E/W Street : Summer St / Main St

City/State : Bridgewater, MA

Weather : Clear

File Name : 20270B13

Site Code : 20270013

Start Date : 10/2/2024

Page No : 1

### Groups Printed- Cars - Trucks

Start Time	Broad St From North			Summer St From East			Central Square From South			Main St From West			Int. Total
	Left	Thru	Right	Left	Thru	Right	Left	Thru	Right	Left	Thru	Right	
07:00 AM	0	110	6	72	59	6	22	116	40	11	21	26	489
07:15 AM	0	109	6	73	54	8	26	106	61	24	34	46	547
07:30 AM	0	120	4	81	50	7	36	144	79	31	22	47	621
07:45 AM	0	97	12	78	57	6	43	100	75	20	45	71	604
<b>Total</b>	<b>0</b>	<b>436</b>	<b>28</b>	<b>304</b>	<b>220</b>	<b>27</b>	<b>127</b>	<b>466</b>	<b>255</b>	<b>86</b>	<b>122</b>	<b>190</b>	<b>2261</b>
08:00 AM	0	123	7	75	43	9	36	101	72	26	28	65	585
08:15 AM	0	101	5	77	53	5	26	101	79	31	34	56	568
08:30 AM	0	111	3	46	40	9	34	119	90	30	37	53	572
08:45 AM	0	105	5	80	37	7	32	114	89	29	47	72	617
<b>Total</b>	<b>0</b>	<b>440</b>	<b>20</b>	<b>278</b>	<b>173</b>	<b>30</b>	<b>128</b>	<b>435</b>	<b>330</b>	<b>116</b>	<b>146</b>	<b>246</b>	<b>2342</b>
<b>Grand Total</b>	<b>0</b>	<b>876</b>	<b>48</b>	<b>582</b>	<b>393</b>	<b>57</b>	<b>255</b>	<b>901</b>	<b>585</b>	<b>202</b>	<b>268</b>	<b>436</b>	<b>4603</b>
Apprch %	0	94.8	5.2	56.4	38.1	5.5	14.6	51.8	33.6	22.3	29.6	48.1	
Total %	0	19	1	12.6	8.5	1.2	5.5	19.6	12.7	4.4	5.8	9.5	
Cars	0	824	46	546	385	55	249	859	544	194	253	422	4377
% Cars	0	94.1	95.8	93.8	98	96.5	97.6	95.3	93	96	94.4	96.8	95.1
Trucks	0	52	2	36	8	2	6	42	41	8	15	14	226
% Trucks	0	5.9	4.2	6.2	2	3.5	2.4	4.7	7	4	5.6	3.2	4.9

Start Time	Broad St From North				Summer St From East				Central Square From South				Main St From West				Int. Total
	Left	Thru	Right	App. Total	Left	Thru	Right	App. Total	Left	Thru	Right	App. Total	Left	Thru	Right	App. Total	
Peak Hour Analysis From 07:00 AM to 08:45 AM - Peak 1 of 1																	
Peak Hour for Entire Intersection Begins at 07:30 AM																	
07:30 AM	0	120	4	124	81	50	7	138	36	144	79	259	31	22	47	100	621
07:45 AM	0	97	12	109	78	57	6	141	43	100	75	218	20	45	71	136	604
08:00 AM	0	123	7	130	75	43	9	127	36	101	72	209	26	28	65	119	585
08:15 AM	0	101	5	106	77	53	5	135	26	101	79	206	31	34	56	121	568
<b>Total Volume</b>	<b>0</b>	<b>441</b>	<b>28</b>	<b>469</b>	<b>311</b>	<b>203</b>	<b>27</b>	<b>541</b>	<b>141</b>	<b>446</b>	<b>305</b>	<b>892</b>	<b>108</b>	<b>129</b>	<b>239</b>	<b>476</b>	<b>2378</b>
% App. Total	0	94	6		57.5	37.5	5		15.8	50	34.2		22.7	27.1	50.2		
PHF	.000	.896	.583	.902	.960	.890	.750	.959	.820	.774	.965	.861	.871	.717	.842	.875	.957
Cars	0	413	26	439	296	198	25	519	137	424	287	848	104	122	231	457	2263
% Cars	0	93.7	92.9	93.6	95.2	97.5	92.6	95.9	97.2	95.1	94.1	95.1	96.3	94.6	96.7	96.0	95.2
Trucks	0	28	2	30	15	5	2	22	4	22	18	44	4	7	8	19	115
% Trucks	0	6.3	7.1	6.4	4.8	2.5	7.4	4.1	2.8	4.9	5.9	4.9	3.7	5.4	3.3	4.0	4.8

# Accurate Counts

978-664-2565

N/S Street : Broad St / Central Square  
 E/W Street : Summer St / Main St  
 City/State : Bridgewater, MA  
 Weather : Clear

File Name : 20270B13  
 Site Code : 20270013  
 Start Date : 10/2/2024  
 Page No : 2

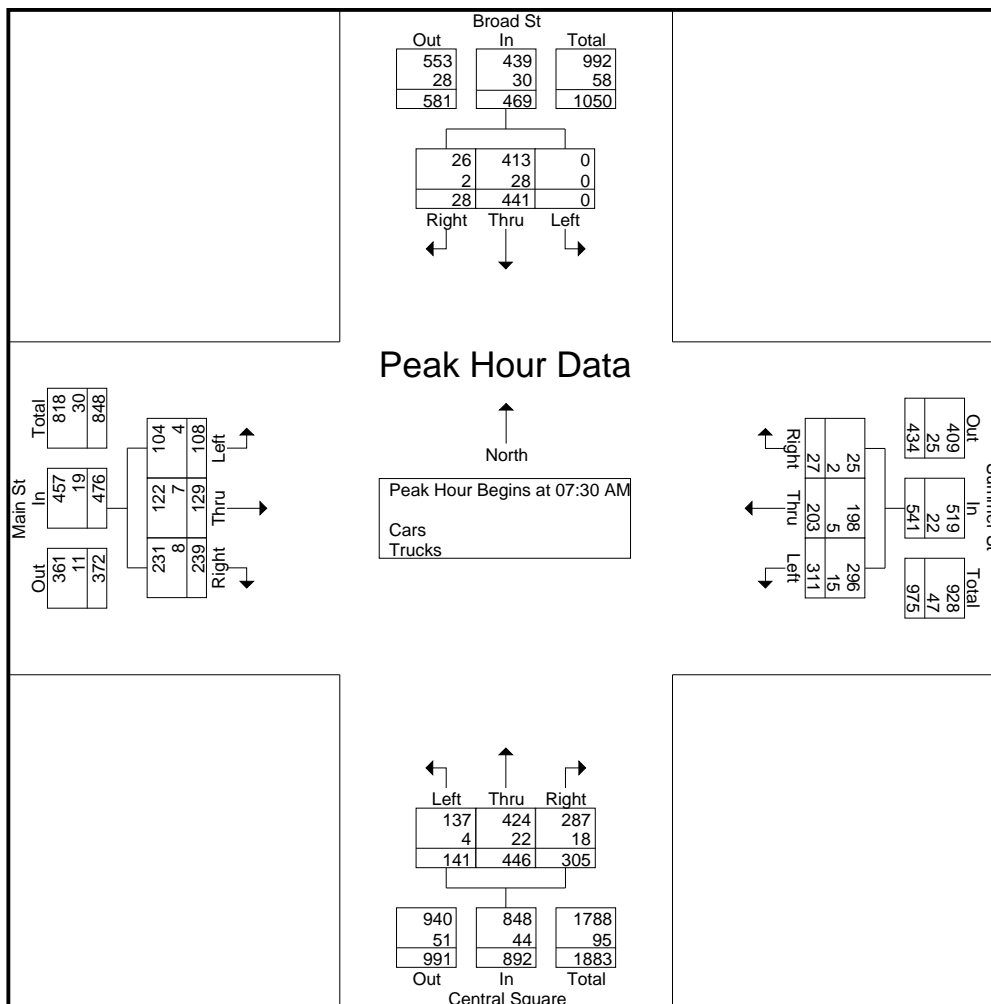

**Peak Hour Analysis From 07:00 AM to 08:45 AM - Peak 1 of 1**

**Peak Hour for Each Approach Begins at:**

	07:15 AM				07:00 AM				08:00 AM				08:00 AM			
+0 mins.	0	109	6	115	72	<b>59</b>	6	137	<b>36</b>	101	72	209	26	28	65	119
+15 mins.	0	120	4	124	73	54	<b>8</b>	135	26	101	79	206	<b>31</b>	34	56	121
+30 mins.	0	97	<b>12</b>	109	<b>81</b>	50	7	138	34	<b>119</b>	<b>90</b>	<b>243</b>	30	37	53	120
+45 mins.	0	<b>123</b>	7	<b>130</b>	78	57	6	<b>141</b>	32	114	89	235	29	<b>47</b>	<b>72</b>	<b>148</b>
Total Volume	0	449	29	478	304	220	27	551	128	435	330	893	116	146	246	508
% App. Total	0	93.9	6.1		55.2	39.9	4.9		14.3	48.7	37		22.8	28.7	48.4	
PHF	.000	.913	.604	.919	.938	.932	.844	.977	.889	.914	.917	.919	.935	.777	.854	.858
Cars	0	421	27	448	296	213	27	536	127	415	305	847	111	138	239	488
% Cars	0	93.8	93.1	93.7	97.4	96.8	100	97.3	99.2	95.4	92.4	94.8	95.7	94.5	97.2	96.1
Trucks	0	28	2	30	8	7	0	15	1	20	25	46	5	8	7	20
% Trucks	0	6.2	6.9	6.3	2.6	3.2	0	2.7	0.8	4.6	7.6	5.2	4.3	5.5	2.8	3.9

# Accurate Counts

978-664-2565

File Name : 20270B13

Site Code : 20270013

Start Date : 10/2/2024

Page No : 3

N/S Street : Broad St / Central Square

E/W Street : Summer St / Main St

City/State : Bridgewater, MA

Weather : Clear

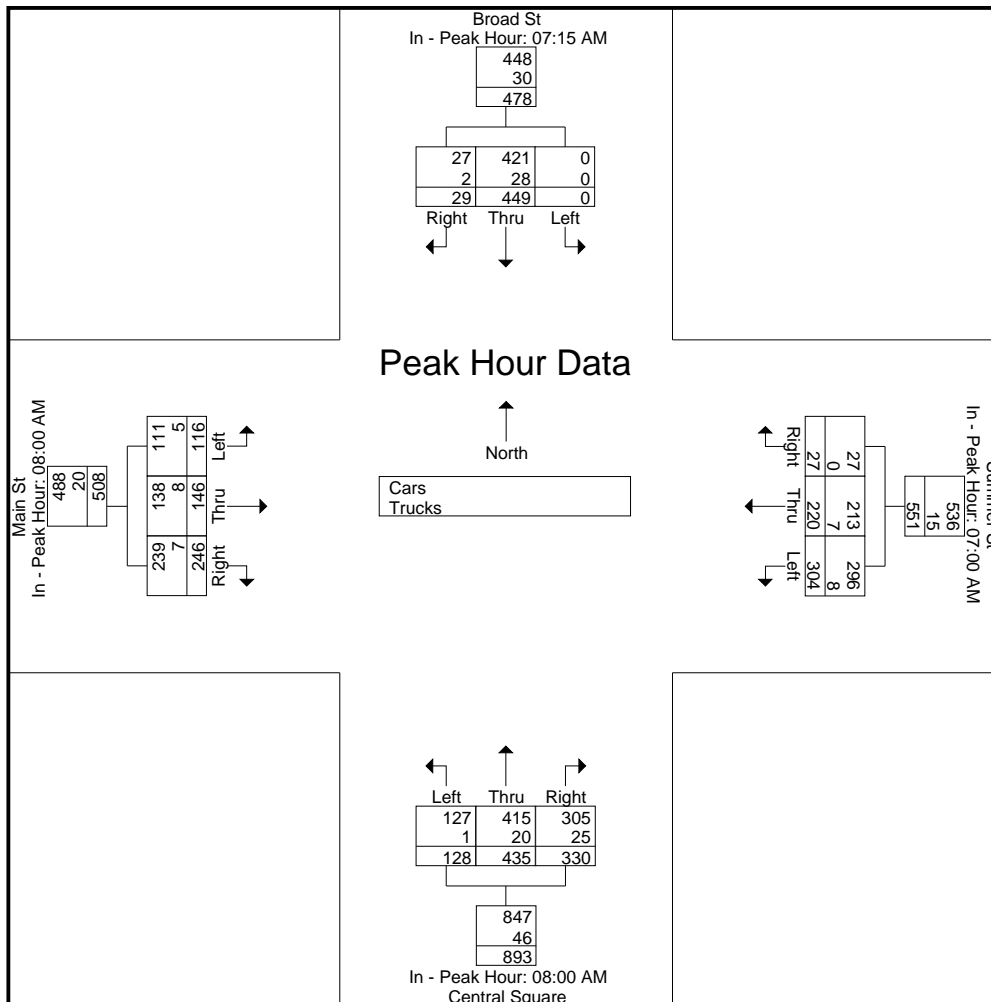

# Accurate Counts

978-664-2565

N/S Street : Broad St / Central Square

E/W Street : Summer St / Main St

City/State : Bridgewater, MA

Weather : Clear

File Name : 20270B13

Site Code : 20270013

Start Date : 10/2/2024

Page No : 4

## Groups Printed- Cars

Start Time	Broad St From North			Summer St From East			Central Square From South			Main St From West			Int. Total
	Left	Thru	Right	Left	Thru	Right	Left	Thru	Right	Left	Thru	Right	
07:00 AM	0	104	6	66	57	6	21	110	35	11	20	26	462
07:15 AM	0	103	6	73	53	8	26	101	58	23	32	45	528
07:30 AM	0	111	4	79	48	7	33	136	73	30	22	43	586
07:45 AM	0	90	11	78	55	6	42	97	73	19	41	69	581
<b>Total</b>	0	408	27	296	213	27	122	444	239	83	115	183	2157
08:00 AM	0	117	6	68	43	8	36	98	68	26	28	64	562
08:15 AM	0	95	5	71	52	4	26	93	73	29	31	55	534
08:30 AM	0	103	3	41	40	9	34	116	78	28	36	51	539
08:45 AM	0	101	5	70	37	7	31	108	86	28	43	69	585
<b>Total</b>	0	416	19	250	172	28	127	415	305	111	138	239	2220
<b>Grand Total</b>	0	824	46	546	385	55	249	859	544	194	253	422	4377
Apprch %	0	94.7	5.3	55.4	39	5.6	15.1	52	32.9	22.3	29.1	48.6	
Total %	0	18.8	1.1	12.5	8.8	1.3	5.7	19.6	12.4	4.4	5.8	9.6	

Start Time	Broad St From North				Summer St From East				Central Square From South				Main St From West				Int. Total
	Left	Thru	Right	App. Total	Left	Thru	Right	App. Total	Left	Thru	Right	App. Total	Left	Thru	Right	App. Total	
<b>Peak Hour Analysis From 07:00 AM to 08:45 AM - Peak 1 of 1</b>																	
<b>Peak Hour for Entire Intersection Begins at 07:30 AM</b>																	
07:30 AM	0	111	4	115	<b>79</b>	48	7	134	33	<b>136</b>	<b>73</b>	<b>242</b>	<b>30</b>	22	43	95	<b>586</b>
07:45 AM	0	90	11	101	78	<b>55</b>	6	<b>139</b>	<b>42</b>	97	73	212	19	<b>41</b>	<b>69</b>	<b>129</b>	581
08:00 AM	0	<b>117</b>	6	<b>123</b>	68	43	<b>8</b>	119	36	98	68	202	26	28	64	118	562
08:15 AM	0	95	5	100	71	52	4	127	26	93	73	192	29	31	55	115	534
<b>Total Volume</b>	0	413	26	439	296	198	25	519	137	424	287	848	104	122	231	457	2263
<b>% App. Total</b>	0	94.1	5.9		57	38.2	4.8		16.2	50	33.8		22.8	26.7	50.5		
PHF	.000	.882	.591	.892	.937	.900	.781	.933	.815	.779	.983	.876	.867	.744	.837	.886	.965

# Accurate Counts

978-664-2565

N/S Street : Broad St / Central Square

E/W Street : Summer St / Main St

City/State : Bridgewater, MA

Weather : Clear

File Name : 20270B13

Site Code : 20270013

Start Date : 10/2/2024

Page No : 5

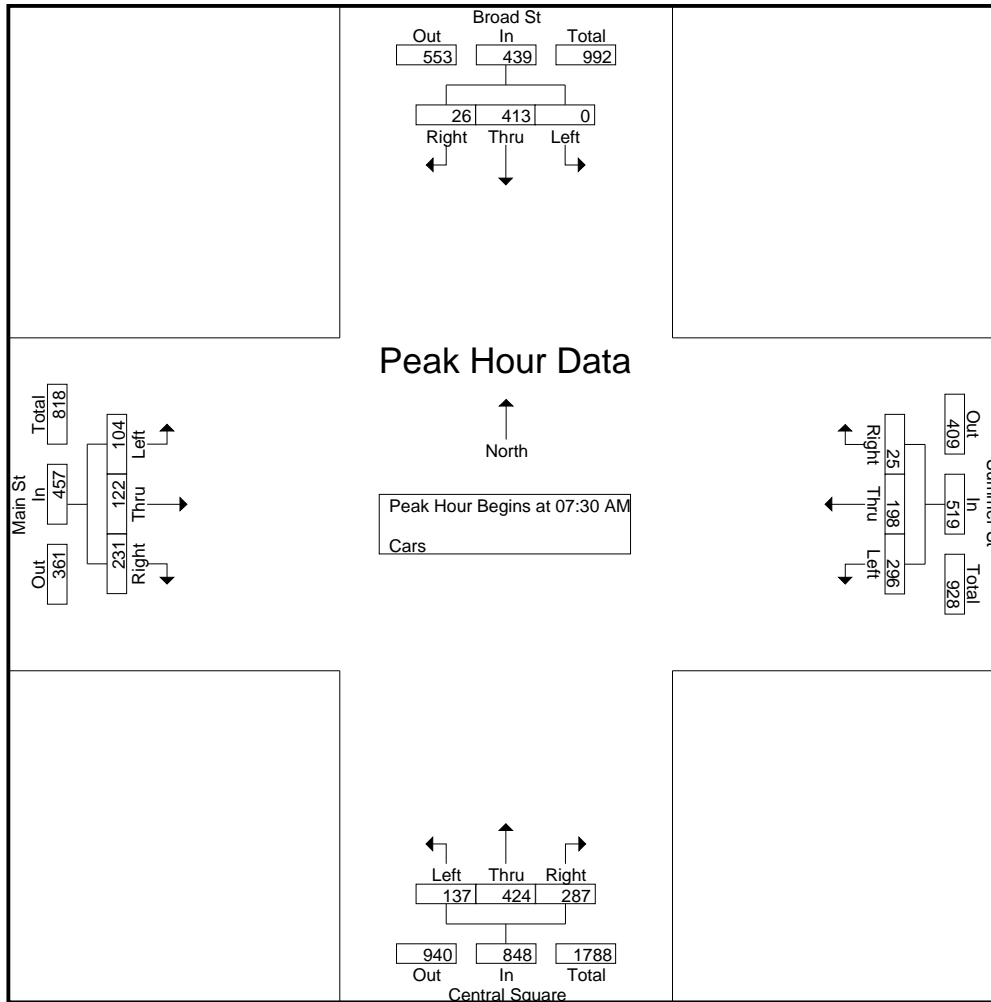

**Peak Hour Analysis From 07:00 AM to 08:45 AM - Peak 1 of 1**

**Peak Hour for Each Approach Begins at:**

	07:15 AM				07:00 AM				07:30 AM				08:00 AM			
+0 mins.	0	103	6	109	66	<b>57</b>	6	129	33	<b>136</b>	<b>73</b>	<b>242</b>	26	28	64	118
+15 mins.	0	111	4	115	73	53	<b>8</b>	134	<b>42</b>	97	73	212	<b>29</b>	31	55	115
+30 mins.	0	90	<b>11</b>	101	<b>79</b>	48	7	134	36	98	68	202	28	36	51	115
+45 mins.	0	<b>117</b>	6	<b>123</b>	78	55	6	<b>139</b>	26	93	73	192	28	<b>43</b>	<b>69</b>	<b>140</b>
Total Volume	0	421	27	448	296	213	27	536	137	424	287	848	111	138	239	488
% App. Total	0	94	6		55.2	39.7	5		16.2	50	33.8		22.7	28.3	49	
PHF	.000	.900	.614	.911	.937	.934	.844	.964	.815	.779	.983	.876	.957	.802	.866	.871

# Accurate Counts

978-664-2565

File Name : 20270B13

Site Code : 20270013

Start Date : 10/2/2024

Page No : 6

N/S Street : Broad St / Central Square

E/W Street : Summer St / Main St

City/State : Bridgewater, MA

Weather : Clear

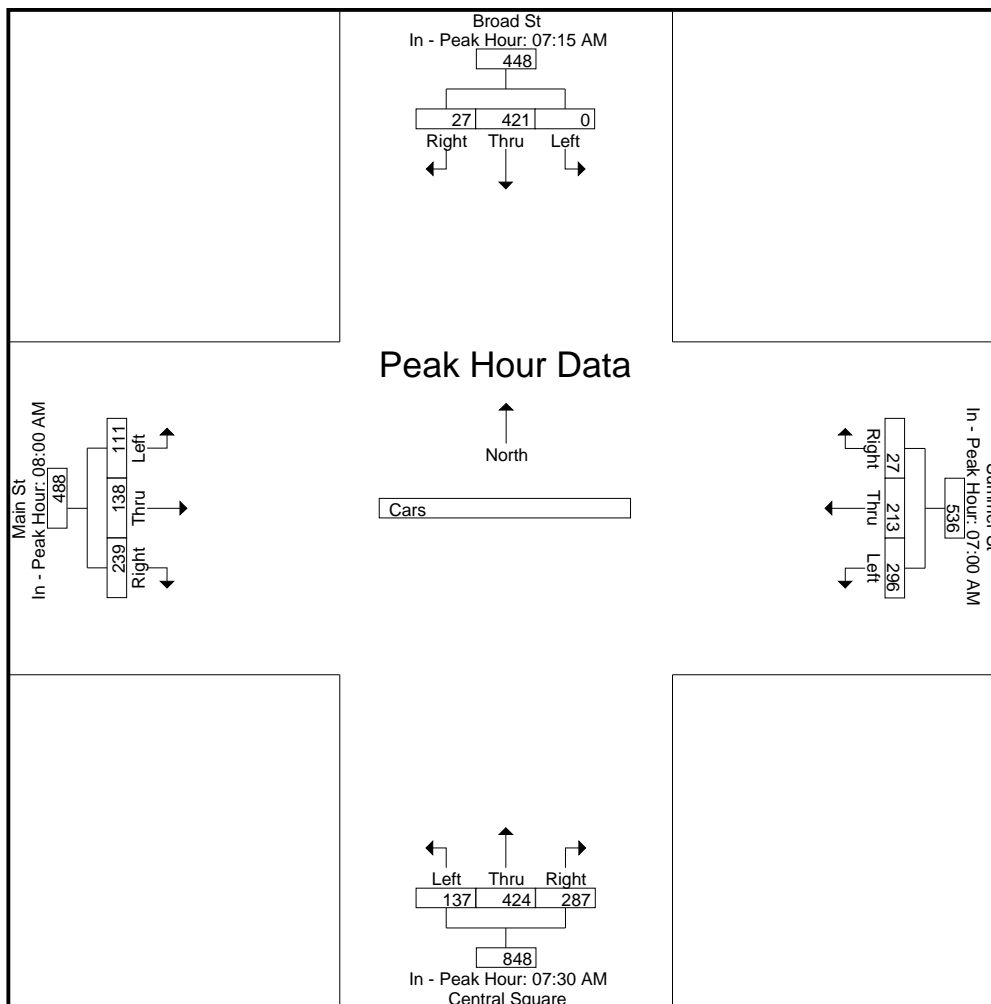

# Accurate Counts

978-664-2565

N/S Street : Broad St / Central Square

E/W Street : Summer St / Main St

City/State : Bridgewater, MA

Weather : Clear

File Name : 20270B13

Site Code : 20270013

Start Date : 10/2/2024

Page No : 7

## Groups Printed- Trucks

Start Time	Broad St From North			Summer St From East			Central Square From South			Main St From West			Int. Total
	Left	Thru	Right	Left	Thru	Right	Left	Thru	Right	Left	Thru	Right	
07:00 AM	0	6	0	6	2	0	1	6	5	0	1	0	27
07:15 AM	0	6	0	0	1	0	0	5	3	1	2	1	19
07:30 AM	0	9	0	2	2	0	3	8	6	1	0	4	35
07:45 AM	0	7	1	0	2	0	1	3	2	1	4	2	23
<b>Total</b>	0	28	1	8	7	0	5	22	16	3	7	7	104
08:00 AM	0	6	1	7	0	1	0	3	4	0	0	1	23
08:15 AM	0	6	0	6	1	1	0	8	6	2	3	1	34
08:30 AM	0	8	0	5	0	0	0	3	12	2	1	2	33
08:45 AM	0	4	0	10	0	0	1	6	3	1	4	3	32
<b>Total</b>	0	24	1	28	1	2	1	20	25	5	8	7	122
<b>Grand Total</b>	0	52	2	36	8	2	6	42	41	8	15	14	226
Apprch %	0	96.3	3.7	78.3	17.4	4.3	6.7	47.2	46.1	21.6	40.5	37.8	
Total %	0	23	0.9	15.9	3.5	0.9	2.7	18.6	18.1	3.5	6.6	6.2	

Start Time	Broad St From North				Summer St From East				Central Square From South				Main St From West				Int. Total
	Left	Thru	Right	App. Total	Left	Thru	Right	App. Total	Left	Thru	Right	App. Total	Left	Thru	Right	App. Total	
<b>Peak Hour Analysis From 07:00 AM to 08:45 AM - Peak 1 of 1</b>																	
<b>Peak Hour for Entire Intersection Begins at 08:00 AM</b>																	
08:00 AM	0	6	1	7	7	0	1	8	0	3	4	7	0	0	1	1	23
08:15 AM	0	6	0	6	6	1	1	8	0	8	6	14	2	3	1	6	34
08:30 AM	0	8	0	8	5	0	0	5	0	3	12	15	2	1	2	5	33
08:45 AM	0	4	0	4	10	0	0	10	1	6	3	10	1	4	3	8	32
<b>Total Volume</b>	0	24	1	25	28	1	2	31	1	20	25	46	5	8	7	20	122
<b>% App. Total</b>	0	96	4		90.3	3.2	6.5		2.2	43.5	54.3		25	40	35		
PHF	.000	.750	.250	.781	.700	.250	.500	.775	.250	.625	.521	.767	.625	.500	.583	.625	.897

# Accurate Counts

978-664-2565

N/S Street : Broad St / Central Square  
 E/W Street : Summer St / Main St  
 City/State : Bridgewater, MA  
 Weather : Clear

File Name : 20270B13  
 Site Code : 20270013  
 Start Date : 10/2/2024  
 Page No : 8

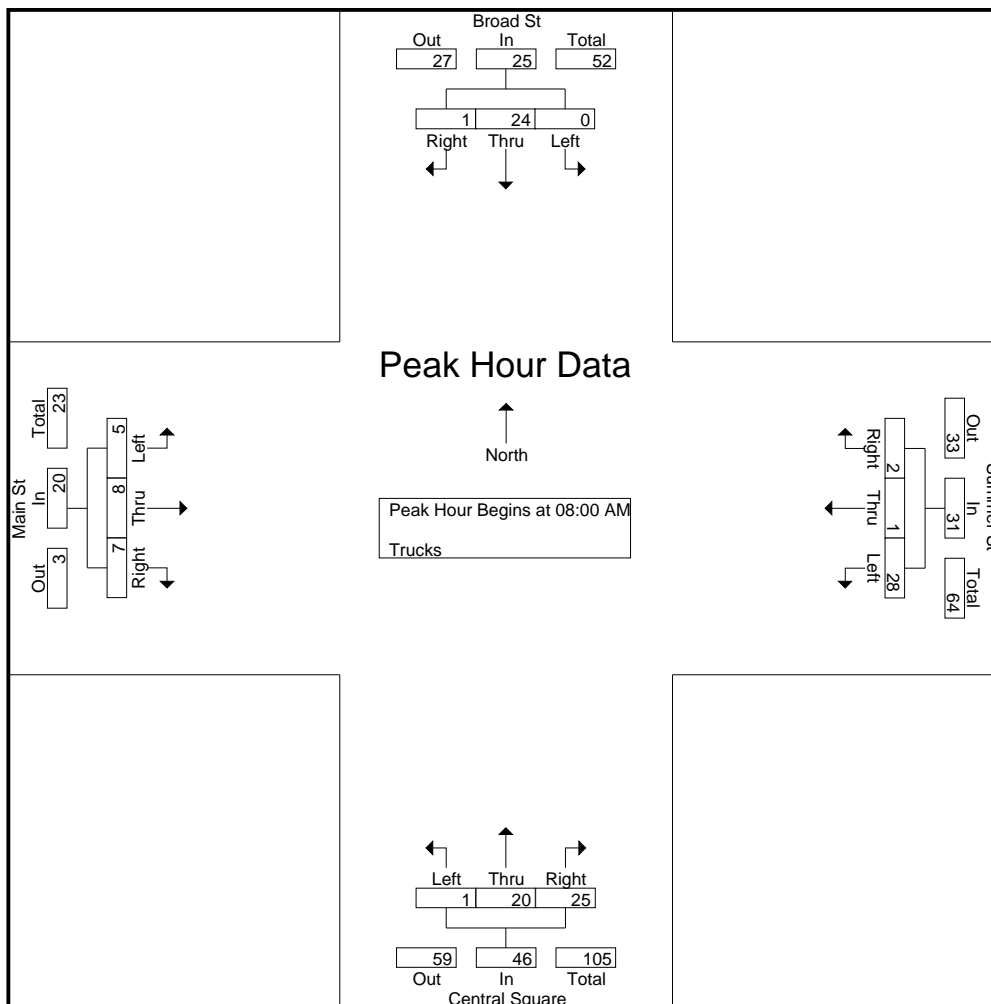

**Peak Hour Analysis From 07:00 AM to 08:45 AM - Peak 1 of 1**

Peak Hour for Each Approach Begins at:

	07:15 AM				08:00 AM				08:00 AM				08:00 AM			
+0 mins.	0	6	0	6	7	0	1	8	0	3	4	7	0	0	1	1
+15 mins.	0	9	0	9	6	1	1	8	0	8	6	14	2	3	1	6
+30 mins.	0	7	1	8	5	0	0	5	0	3	12	15	2	1	2	5
+45 mins.	0	6	1	7	10	0	0	10	1	6	3	10	1	4	3	8
Total Volume	0	28	2	30	28	1	2	31	1	20	25	46	5	8	7	20
% App. Total	0	93.3	6.7		90.3	3.2	6.5		2.2	43.5	54.3		25	40	35	
PHF	.000	.778	.500	.833	.700	.250	.500	.775	.250	.625	.521	.767	.625	.500	.583	.625



# Accurate Counts

978-664-2565

File Name : 20270B13

Site Code : 20270013

Start Date : 10/2/2024

Page No : 9

N/S Street : Broad St / Central Square

E/W Street : Summer St / Main St

City/State : Bridgewater, MA

Weather : Clear

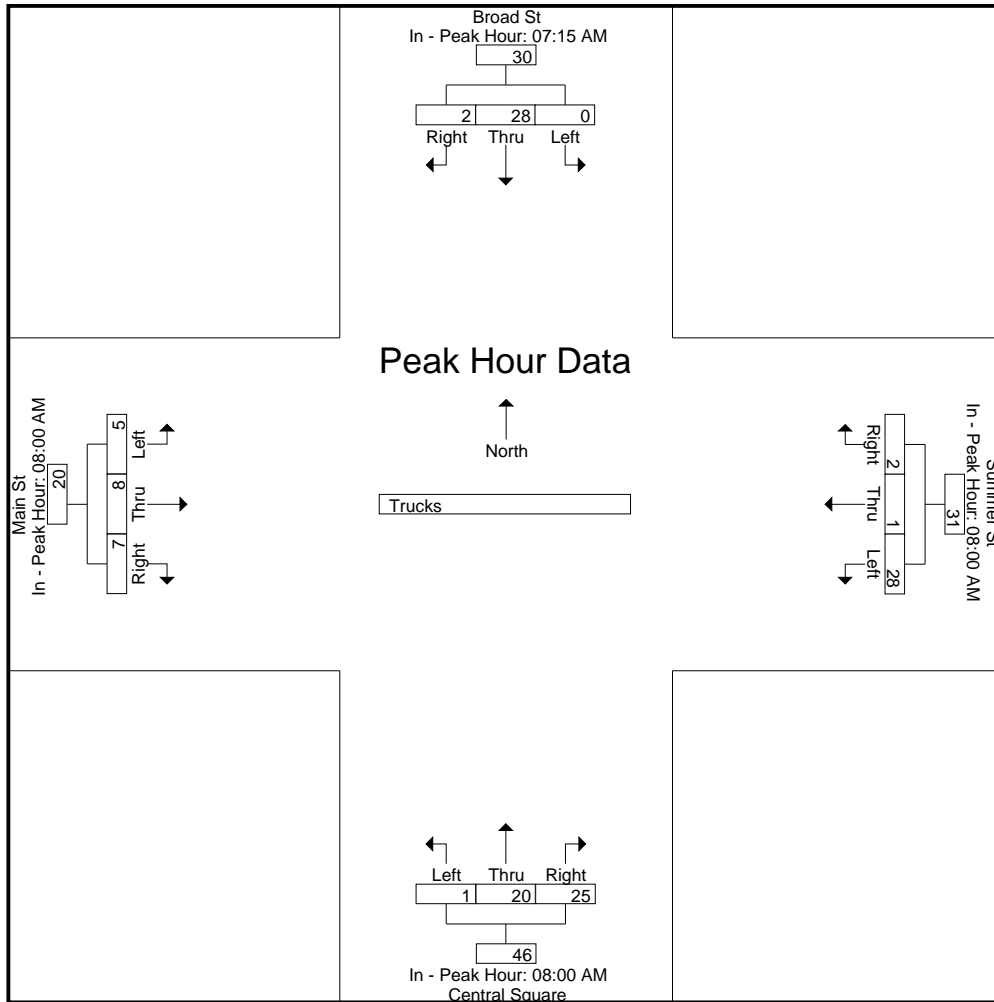

# Accurate Counts

978-664-2565

N/S Street : Broad St / Central Square

E/W Street : Summer St / Main St

City/State : Bridgewater, MA

Weather : Clear

File Name : 20270B13

Site Code : 20270013

Start Date : 10/2/2024

Page No : 10

## Groups Printed- Bikes Peds

Start Time	Broad St From North				Summer St From East				Central Square From South				Main St From West				Exclu. Total	Inclu. Total	Int. Total
	Left	Thru	Right	Peds	Left	Thru	Right	Peds	Left	Thru	Right	Peds	Left	Thru	Right	Peds			
07:00 AM	0	0	0	0	0	0	0	0	0	0	0	0	0	0	0	0	0	0	0
07:15 AM	0	0	0	0	0	0	0	1	0	0	0	0	0	0	0	0	1	0	1
07:30 AM	0	0	0	1	0	0	0	0	0	0	0	0	0	0	0	0	1	0	1
07:45 AM	0	0	0	0	0	0	0	1	0	0	0	1	0	0	0	1	3	0	3
<b>Total</b>	0	0	0	1	0	0	0	2	0	0	0	1	0	0	0	1	5	0	5
08:00 AM	0	0	0	0	0	0	0	0	0	0	0	0	0	0	0	1	1	0	1
08:15 AM	0	0	0	0	0	0	0	0	0	0	0	0	0	0	0	0	0	0	0
08:30 AM	0	0	0	0	0	0	0	2	0	0	0	0	0	0	0	1	3	0	3
08:45 AM	0	0	0	1	0	0	0	0	0	0	0	2	0	0	0	1	4	0	4
<b>Total</b>	0	0	0	1	0	0	0	2	0	0	0	2	0	0	0	3	8	0	8
<b>Grand Total</b>	0	0	0	2	0	0	0	4	0	0	0	3	0	0	0	4	13	0	13
Apprch %	0	0	0		0	0	0		0	0	0		0	0	0				
Total %																	100	0	

Start Time	Broad St From North				Summer St From East				Central Square From South				Main St From West				Int. Total	
	Left	Thru	Right	App. Total	Left	Thru	Right	App. Total	Left	Thru	Right	App. Total	Left	Thru	Right	App. Total		
Peak Hour Analysis From 07:00 AM to 08:45 AM - Peak 1 of 1																		
Peak Hour for Entire Intersection Begins at 07:00 AM																		
07:00 AM	0	0	0	0	0	0	0	0	0	0	0	0	0	0	0	0	0	0
07:15 AM	0	0	0	0	0	0	0	0	0	0	0	0	0	0	0	0	0	0
07:30 AM	0	0	0	0	0	0	0	0	0	0	0	0	0	0	0	0	0	0
07:45 AM	0	0	0	0	0	0	0	0	0	0	0	0	0	0	0	0	0	0
<b>Total Volume</b>	0	0	0	0	0	0	0	0	0	0	0	0	0	0	0	0	0	0
<b>% App. Total</b>	0	0	0		0	0	0		0	0	0		0	0	0			
PHF	.000	.000	.000	.000	.000	.000	.000	.000	.000	.000	.000	.000	.000	.000	.000	.000	.000	.000

# Accurate Counts

978-664-2565

N/S Street : Broad St / Central Square  
 E/W Street : Summer St / Main St  
 City/State : Bridgewater, MA  
 Weather : Clear

File Name : 20270B13  
 Site Code : 20270013  
 Start Date : 10/2/2024  
 Page No : 11

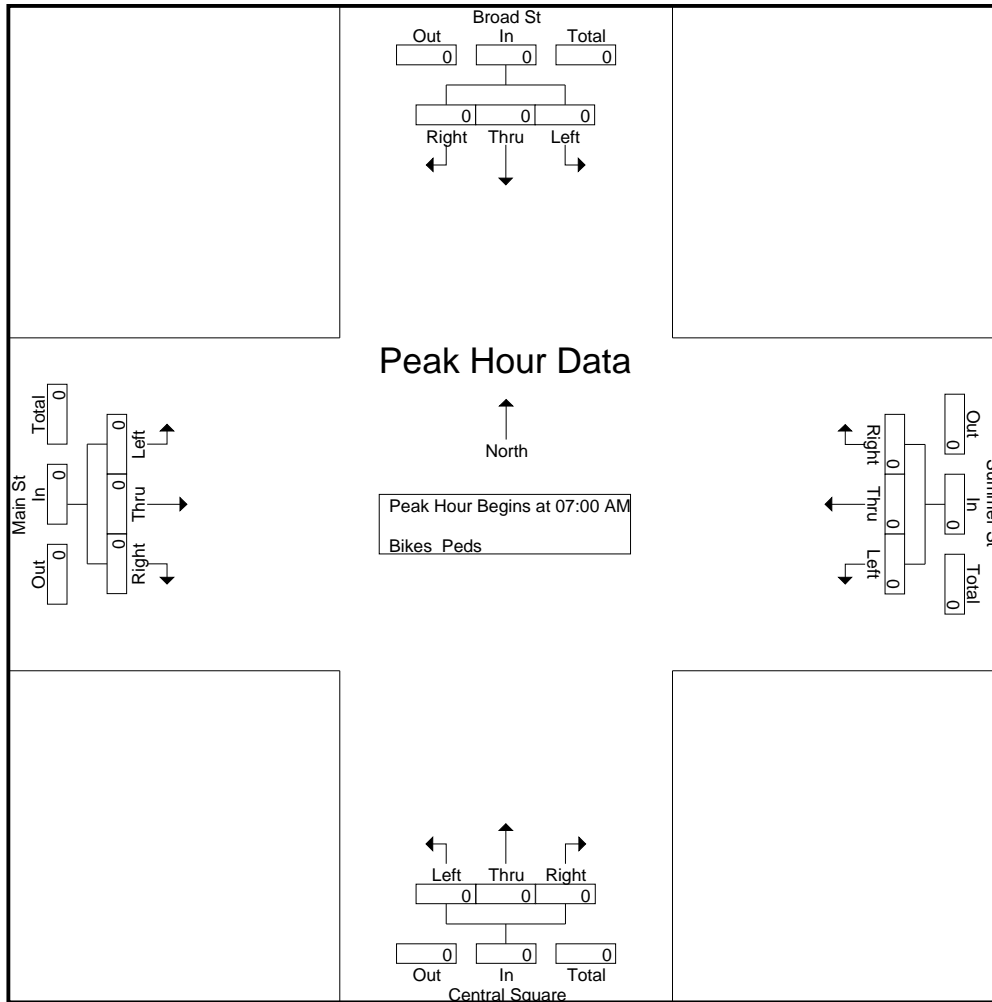

**Peak Hour Analysis From 07:00 AM to 08:45 AM - Peak 1 of 1**

**Peak Hour for Each Approach Begins at:**

	07:00 AM				07:00 AM				07:00 AM				07:00 AM			
+0 mins.	0	0	0	0	0	0	0	0	0	0	0	0	0	0	0	0
+15 mins.	0	0	0	0	0	0	0	0	0	0	0	0	0	0	0	0
+30 mins.	0	0	0	0	0	0	0	0	0	0	0	0	0	0	0	0
+45 mins.	0	0	0	0	0	0	0	0	0	0	0	0	0	0	0	0
Total Volume	0	0	0	0	0	0	0	0	0	0	0	0	0	0	0	0
% App. Total	0	0	0	0	0	0	0	0	0	0	0	0	0	0	0	0
PHF	.000	.000	.000	.000	.000	.000	.000	.000	.000	.000	.000	.000	.000	.000	.000	.000

# Accurate Counts

978-664-2565

File Name : 20270B13

Site Code : 20270013

Start Date : 10/2/2024

Page No : 12

N/S Street : Broad St / Central Square

E/W Street : Summer St / Main St

City/State : Bridgewater, MA

Weather : Clear

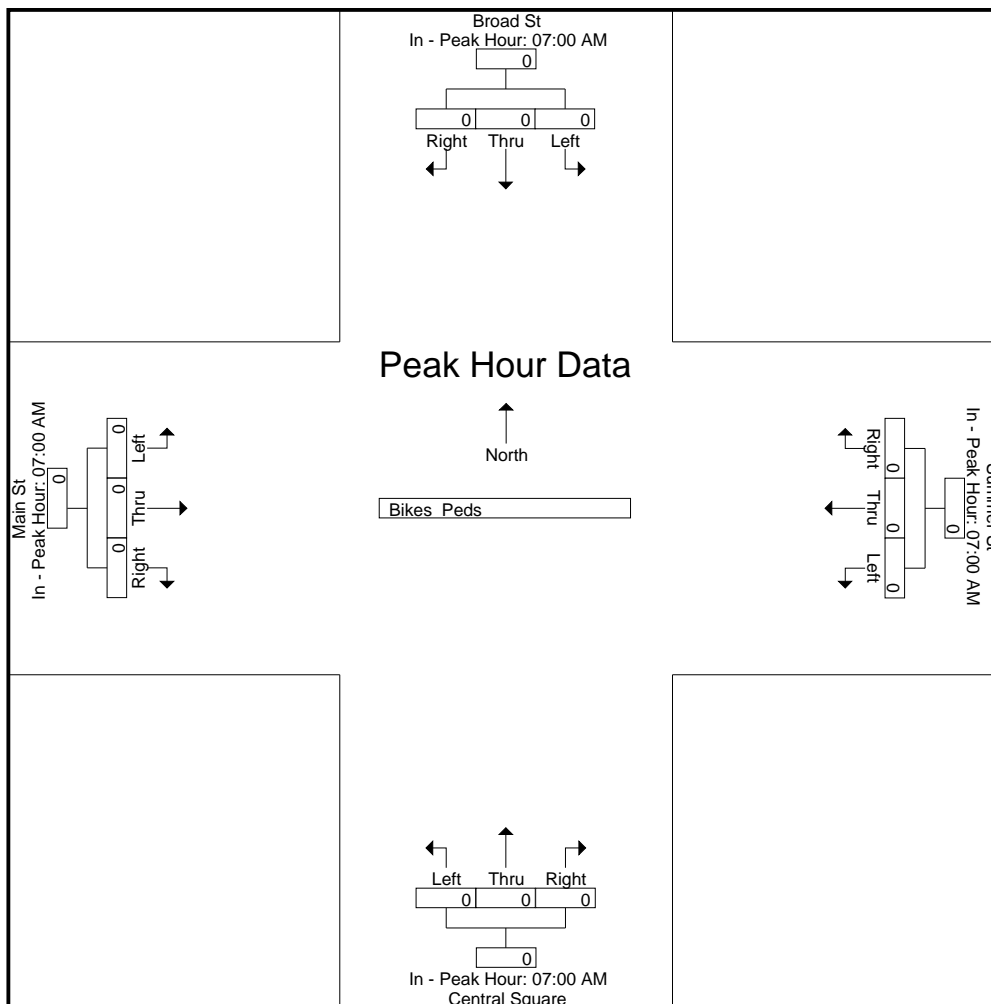

# Accurate Counts

978-664-2565

N/S Street : Broad St / Central Square

E/W Street : Summer St / Main St

City/State : Bridgewater, MA

Weather : Clear

File Name : 20270B13

Site Code : 20270013

Start Date : 10/2/2024

Page No : 1

### Groups Printed- Cars - Trucks

Start Time	Broad St From North			Summer St From East			Central Square From South			Main St From West			Int. Total
	Left	Thru	Right	Left	Thru	Right	Left	Thru	Right	Left	Thru	Right	
04:00 PM	0	106	2	94	54	8	37	116	81	26	41	72	637
04:15 PM	0	105	3	72	51	12	35	130	80	26	39	86	639
04:30 PM	1	113	3	90	68	13	32	113	97	22	39	95	686
04:45 PM	0	106	5	69	71	16	46	125	89	20	46	71	664
<b>Total</b>	<b>1</b>	<b>430</b>	<b>13</b>	<b>325</b>	<b>244</b>	<b>49</b>	<b>150</b>	<b>484</b>	<b>347</b>	<b>94</b>	<b>165</b>	<b>324</b>	<b>2626</b>
05:00 PM	0	119	2	86	58	11	27	97	99	23	40	98	660
05:15 PM	0	114	4	93	68	10	43	114	82	26	40	82	676
05:30 PM	1	113	7	94	76	9	31	110	97	24	40	77	679
05:45 PM	0	106	11	84	49	7	33	100	80	28	43	66	607
<b>Total</b>	<b>1</b>	<b>452</b>	<b>24</b>	<b>357</b>	<b>251</b>	<b>37</b>	<b>134</b>	<b>421</b>	<b>358</b>	<b>101</b>	<b>163</b>	<b>323</b>	<b>2622</b>
<b>Grand Total</b>	<b>2</b>	<b>882</b>	<b>37</b>	<b>682</b>	<b>495</b>	<b>86</b>	<b>284</b>	<b>905</b>	<b>705</b>	<b>195</b>	<b>328</b>	<b>647</b>	<b>5248</b>
Apprch %	0.2	95.8	4	54	39.2	6.8	15	47.8	37.2	16.7	28	55.3	
Total %	0	16.8	0.7	13	9.4	1.6	5.4	17.2	13.4	3.7	6.2	12.3	
Cars	2	867	37	674	491	86	280	882	690	195	326	642	5172
% Cars	100	98.3	100	98.8	99.2	100	98.6	97.5	97.9	100	99.4	99.2	98.6
Trucks	0	15	0	8	4	0	4	23	15	0	2	5	76
% Trucks	0	1.7	0	1.2	0.8	0	1.4	2.5	2.1	0	0.6	0.8	1.4

Start Time	Broad St From North				Summer St From East				Central Square From South				Main St From West				Int. Total
	Left	Thru	Right	App. Total	Left	Thru	Right	App. Total	Left	Thru	Right	App. Total	Left	Thru	Right	App. Total	
Peak Hour Analysis From 04:00 PM to 05:45 PM - Peak 1 of 1																	
Peak Hour for Entire Intersection Begins at 04:30 PM																	
04:30 PM	1	113	3	117	90	68	13	171	32	113	97	242	22	39	95	156	686
04:45 PM	0	106	5	111	69	71	16	156	46	125	89	260	20	46	71	137	664
05:00 PM	0	119	2	121	86	58	11	155	27	97	99	223	23	40	98	161	660
05:15 PM	0	114	4	118	93	68	10	171	43	114	82	239	26	40	82	148	676
<b>Total Volume</b>	<b>1</b>	<b>452</b>	<b>14</b>	<b>467</b>	<b>338</b>	<b>265</b>	<b>50</b>	<b>653</b>	<b>148</b>	<b>449</b>	<b>367</b>	<b>964</b>	<b>91</b>	<b>165</b>	<b>346</b>	<b>602</b>	<b>2686</b>
% App. Total	0.2	96.8	3		51.8	40.6	7.7		15.4	46.6	38.1		15.1	27.4	57.5		
PHF	.250	.950	.700	.965	.909	.933	.781	.955	.804	.898	.927	.927	.875	.897	.883	.935	.979
Cars	1	444	14	459	334	263	50	647	144	437	360	941	91	165	346	602	2649
% Cars	100	98.2	100	98.3	98.8	99.2	100	99.1	97.3	97.3	98.1	97.6	100	100	100	100	98.6
Trucks	0	8	0	8	4	2	0	6	4	12	7	23	0	0	0	0	37
% Trucks	0	1.8	0	1.7	1.2	0.8	0	0.9	2.7	2.7	1.9	2.4	0	0	0	0	1.4

# Accurate Counts

978-664-2565

N/S Street : Broad St / Central Square

E/W Street : Summer St / Main St

City/State : Bridgewater, MA

Weather : Clear

File Name : 20270B13

Site Code : 20270013

Start Date : 10/2/2024

Page No : 2

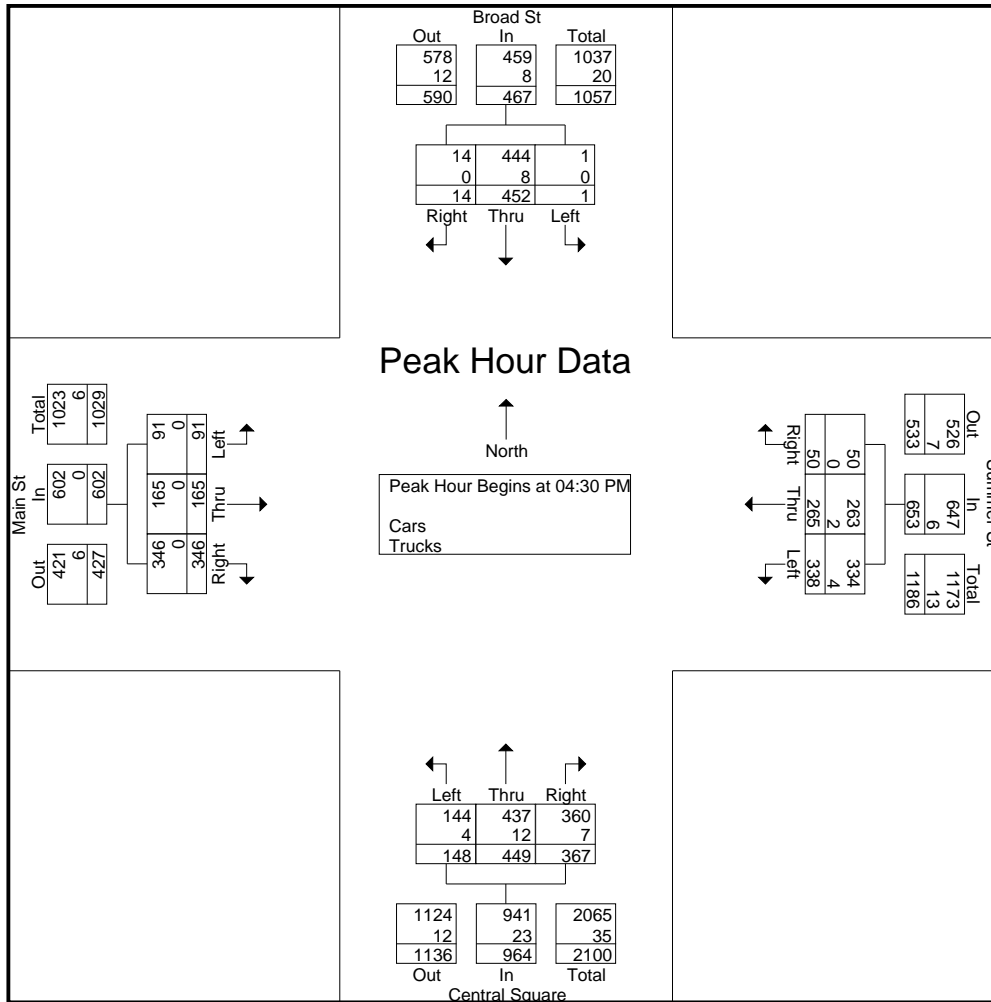

**Peak Hour Analysis From 04:00 PM to 05:45 PM - Peak 1 of 1**

**Peak Hour for Each Approach Begins at:**

	05:00 PM				04:45 PM				04:00 PM				04:15 PM			
+0 mins.	0	<b>119</b>	2	<b>121</b>	69	71	<b>16</b>	156	37	116	81	234	<b>26</b>	39	86	151
+15 mins.	0	114	4	118	86	58	11	155	35	<b>130</b>	80	245	22	39	95	156
+30 mins.	<b>1</b>	113	7	121	93	68	10	171	32	113	<b>97</b>	242	20	<b>46</b>	71	137
+45 mins.	0	106	<b>11</b>	117	<b>94</b>	<b>76</b>	9	<b>179</b>	<b>46</b>	125	89	<b>260</b>	23	40	<b>98</b>	<b>161</b>
Total Volume	1	452	24	477	342	273	46	661	150	484	347	981	91	164	350	605
% App. Total	0.2	94.8	5		51.7	41.3	7		15.3	49.3	35.4		15	27.1	57.9	
PHF	.250	.950	.545	.986	.910	.898	.719	.923	.815	.931	.894	.943	.875	.891	.893	.939
Cars	1	448	24	473	339	270	46	655	148	467	334	949	91	163	350	604
% Cars	100	99.1	100	99.2	99.1	98.9	100	99.1	98.7	96.5	96.3	96.7	100	99.4	100	99.8
Trucks	0	4	0	4	3	3	0	6	2	17	13	32	0	1	0	1
% Trucks	0	0.9	0	0.8	0.9	1.1	0	0.9	1.3	3.5	3.7	3.3	0	0.6	0	0.2

# Accurate Counts

978-664-2565

N/S Street : Broad St / Central Square  
 E/W Street : Summer St / Main St  
 City/State : Bridgewater, MA  
 Weather : Clear

File Name : 20270B13  
 Site Code : 20270013  
 Start Date : 10/2/2024  
 Page No : 3

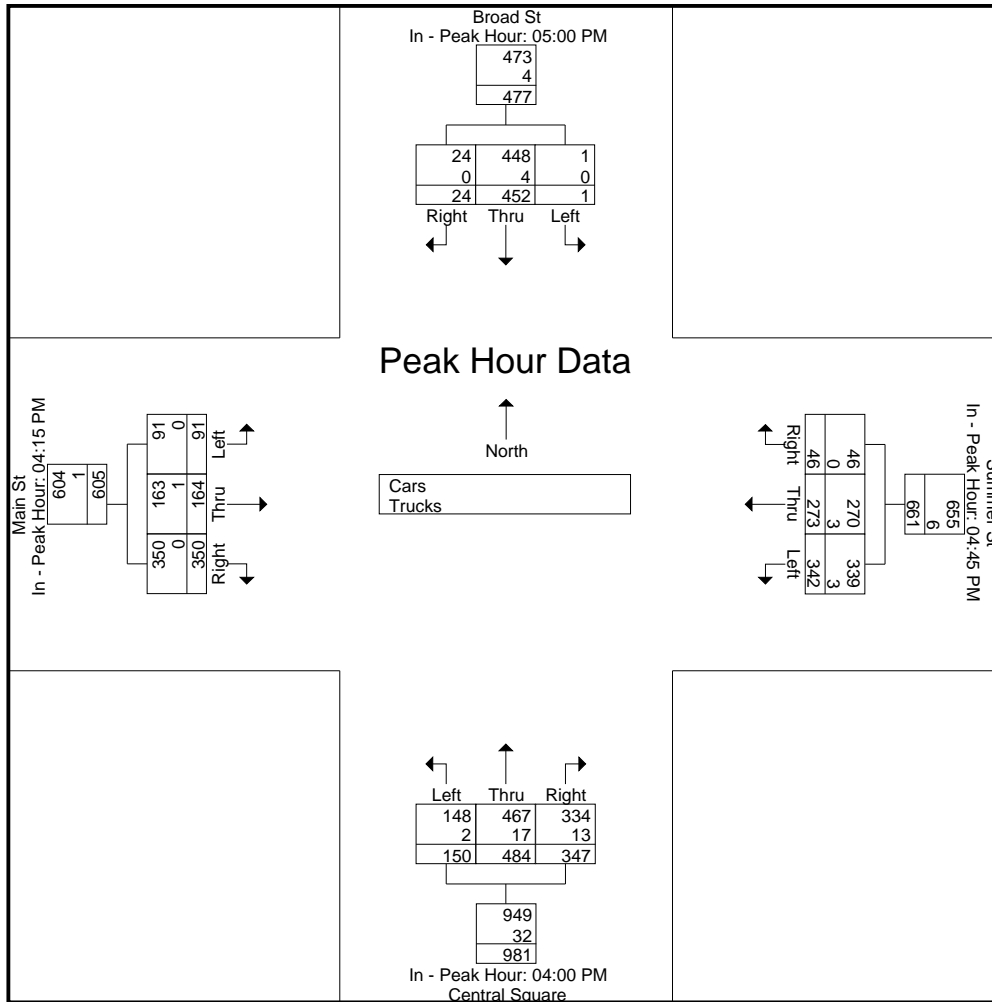

# Accurate Counts

978-664-2565

N/S Street : Broad St / Central Square  
 E/W Street : Summer St / Main St  
 City/State : Bridgewater, MA  
 Weather : Clear

File Name : 20270B13  
 Site Code : 20270013  
 Start Date : 10/2/2024  
 Page No : 4

### Groups Printed- Cars

Start Time	Broad St From North			Summer St From East			Central Square From South			Main St From West			Int. Total
	Left	Thru	Right	Left	Thru	Right	Left	Thru	Right	Left	Thru	Right	
04:00 PM	0	104	2	94	54	8	37	113	78	26	40	68	624
04:15 PM	0	101	3	68	50	12	35	125	76	26	38	86	620
04:30 PM	1	110	3	89	68	13	31	111	93	22	39	95	675
04:45 PM	0	104	5	67	69	16	45	118	87	20	46	71	648
<b>Total</b>	<b>1</b>	<b>419</b>	<b>13</b>	<b>318</b>	<b>241</b>	<b>49</b>	<b>148</b>	<b>467</b>	<b>334</b>	<b>94</b>	<b>163</b>	<b>320</b>	<b>2567</b>
05:00 PM	0	117	2	85	58	11	25	96	99	23	40	98	654
05:15 PM	0	113	4	93	68	10	43	112	81	26	40	82	672
05:30 PM	1	112	7	94	75	9	31	109	96	24	40	77	675
05:45 PM	0	106	11	84	49	7	33	98	80	28	43	65	604
<b>Total</b>	<b>1</b>	<b>448</b>	<b>24</b>	<b>356</b>	<b>250</b>	<b>37</b>	<b>132</b>	<b>415</b>	<b>356</b>	<b>101</b>	<b>163</b>	<b>322</b>	<b>2605</b>
<b>Grand Total</b>	<b>2</b>	<b>867</b>	<b>37</b>	<b>674</b>	<b>491</b>	<b>86</b>	<b>280</b>	<b>882</b>	<b>690</b>	<b>195</b>	<b>326</b>	<b>642</b>	<b>5172</b>
Apprch %	0.2	95.7	4.1	53.9	39.2	6.9	15.1	47.6	37.3	16.8	28	55.2	
Total %	0	16.8	0.7	13	9.5	1.7	5.4	17.1	13.3	3.8	6.3	12.4	

Start Time	Broad St From North				Summer St From East				Central Square From South				Main St From West				Int. Total
	Left	Thru	Right	App. Total	Left	Thru	Right	App. Total	Left	Thru	Right	App. Total	Left	Thru	Right	App. Total	
Peak Hour Analysis From 04:00 PM to 05:45 PM - Peak 1 of 1																	
Peak Hour for Entire Intersection Begins at 04:30 PM																	
04:30 PM	1	110	3	114	89	68	13	170	31	111	93	235	22	39	95	156	<b>675</b>
04:45 PM	0	104	5	109	67	<b>69</b>	<b>16</b>	152	<b>45</b>	<b>118</b>	87	<b>250</b>	20	<b>46</b>	71	137	648
05:00 PM	0	<b>117</b>	2	<b>119</b>	85	58	11	154	25	96	<b>99</b>	220	23	40	<b>98</b>	<b>161</b>	654
05:15 PM	0	113	4	117	<b>93</b>	68	10	<b>171</b>	43	112	81	236	<b>26</b>	40	82	148	672
Total Volume	1	444	14	459	334	263	50	647	144	437	360	941	91	165	346	602	2649
% App. Total	0.2	96.7	3.1		51.6	40.6	7.7		15.3	46.4	38.3		15.1	27.4	57.5		
PHF	.250	.949	.700	.964	.898	.953	.781	.946	.800	.926	.909	.941	.875	.897	.883	.935	.981



# Accurate Counts

978-664-2565

N/S Street : Broad St / Central Square

E/W Street : Summer St / Main St

City/State : Bridgewater, MA

Weather : Clear

File Name : 20270B13

Site Code : 20270013

Start Date : 10/2/2024

Page No : 5

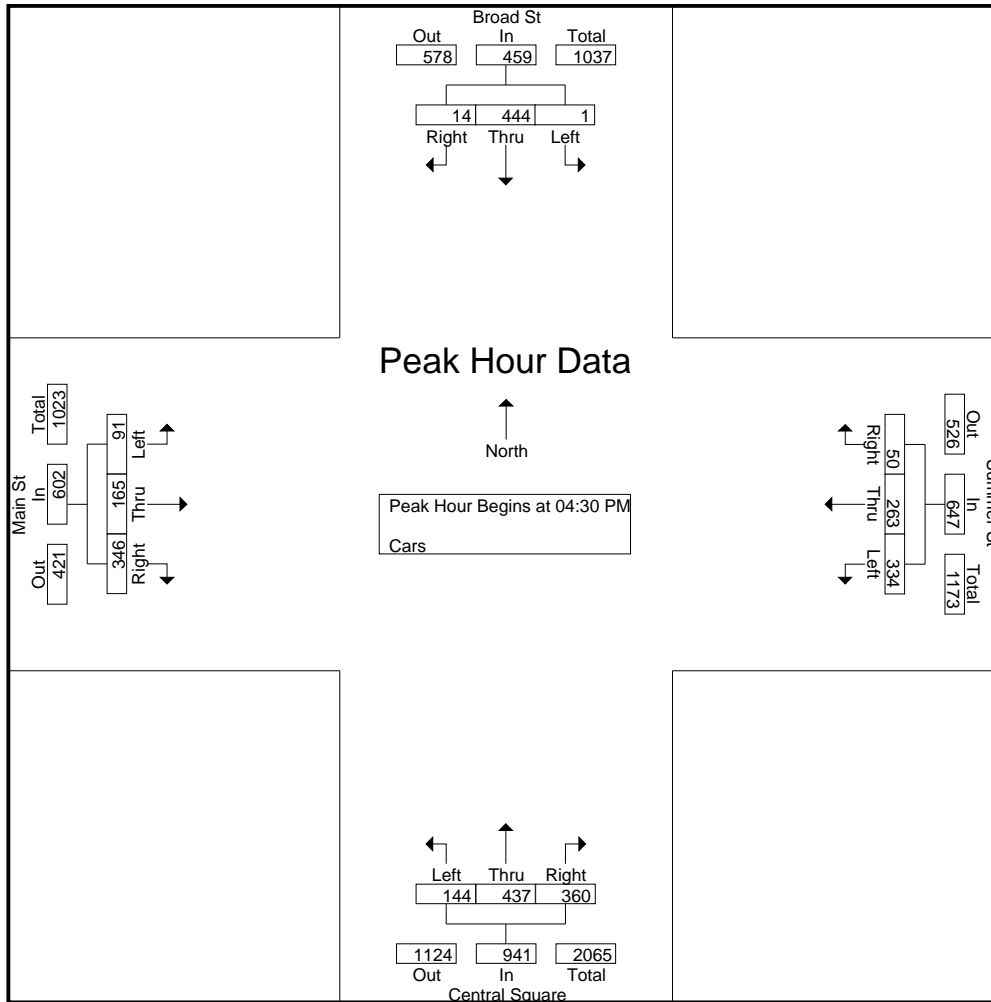

**Peak Hour Analysis From 04:00 PM to 05:45 PM - Peak 1 of 1**

**Peak Hour for Each Approach Begins at:**

	05:00 PM				04:45 PM				04:00 PM				04:15 PM			
+0 mins.	0	117	2	119	67	69	16	152	37	113	78	228	26	38	86	150
+15 mins.	0	113	4	117	85	58	11	154	35	125	76	236	22	39	95	156
+30 mins.	1	112	7	120	93	68	10	171	31	111	93	235	20	46	71	137
+45 mins.	0	106	11	117	94	75	9	178	45	118	87	250	23	40	98	161
Total Volume	1	448	24	473	339	270	46	655	148	467	334	949	91	163	350	604
% App. Total	0.2	94.7	5.1		51.8	41.2	7		15.6	49.2	35.2		15.1	27	57.9	
PHF	.250	.957	.545	.985	.902	.900	.719	.920	.822	.934	.898	.949	.875	.886	.893	.938

# Accurate Counts

978-664-2565

File Name : 20270B13

Site Code : 20270013

Start Date : 10/2/2024

Page No : 6

N/S Street : Broad St / Central Square

E/W Street : Summer St / Main St

City/State : Bridgewater, MA

Weather : Clear

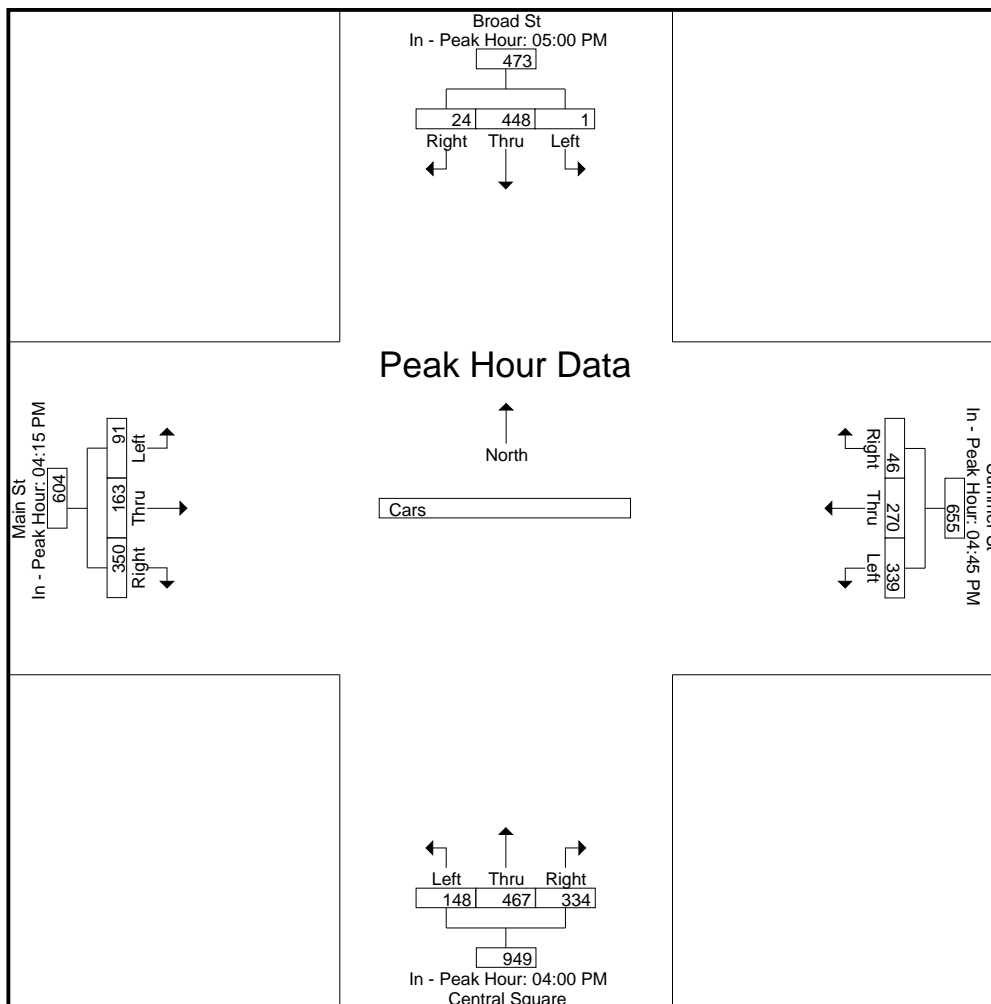

# Accurate Counts

978-664-2565

N/S Street : Broad St / Central Square

E/W Street : Summer St / Main St

City/State : Bridgewater, MA

Weather : Clear

File Name : 20270B13

Site Code : 20270013

Start Date : 10/2/2024

Page No : 7

### Groups Printed- Trucks

Start Time	Broad St From North			Summer St From East			Central Square From South			Main St From West			Int. Total
	Left	Thru	Right	Left	Thru	Right	Left	Thru	Right	Left	Thru	Right	
04:00 PM	0	2	0	0	0	0	0	3	3	0	1	4	13
04:15 PM	0	4	0	4	1	0	0	5	4	0	1	0	19
04:30 PM	0	3	0	1	0	0	1	2	4	0	0	0	11
04:45 PM	0	2	0	2	2	0	1	7	2	0	0	0	16
<b>Total</b>	0	11	0	7	3	0	2	17	13	0	2	4	59
05:00 PM	0	2	0	1	0	0	2	1	0	0	0	0	6
05:15 PM	0	1	0	0	0	0	0	2	1	0	0	0	4
05:30 PM	0	1	0	0	1	0	0	1	1	0	0	0	4
05:45 PM	0	0	0	0	0	0	0	2	0	0	0	1	3
<b>Total</b>	0	4	0	1	1	0	2	6	2	0	0	1	17
<b>Grand Total</b>	0	15	0	8	4	0	4	23	15	0	2	5	76
Apprch %	0	100	0	66.7	33.3	0	9.5	54.8	35.7	0	28.6	71.4	
Total %	0	19.7	0	10.5	5.3	0	5.3	30.3	19.7	0	2.6	6.6	

Start Time	Broad St From North				Summer St From East				Central Square From South				Main St From West				Int. Total
	Left	Thru	Right	App. Total	Left	Thru	Right	App. Total	Left	Thru	Right	App. Total	Left	Thru	Right	App. Total	
<b>Peak Hour Analysis From 04:00 PM to 05:45 PM - Peak 1 of 1</b>																	
<b>Peak Hour for Entire Intersection Begins at 04:00 PM</b>																	
04:00 PM	0	2	0	2	0	0	0	0	0	3	3	6	0	1	4	5	13
04:15 PM	0	4	0	4	4	1	0	5	0	5	4	9	0	1	0	1	19
04:30 PM	0	3	0	3	1	0	0	1	1	2	4	7	0	0	0	0	11
04:45 PM	0	2	0	2	2	2	0	4	1	7	2	10	0	0	0	0	16
<b>Total Volume</b>	0	11	0	11	7	3	0	10	2	17	13	32	0	2	4	6	59
<b>% App. Total</b>	0	100	0		70	30	0		6.2	53.1	40.6		0	33.3	66.7		
PHF	.000	.688	.000	.688	.438	.375	.000	.500	.500	.607	.813	.800	.000	.500	.250	.300	.776

# Accurate Counts

978-664-2565

N/S Street : Broad St / Central Square

E/W Street : Summer St / Main St

City/State : Bridgewater, MA

Weather : Clear

File Name : 20270B13

Site Code : 20270013

Start Date : 10/2/2024

Page No : 8

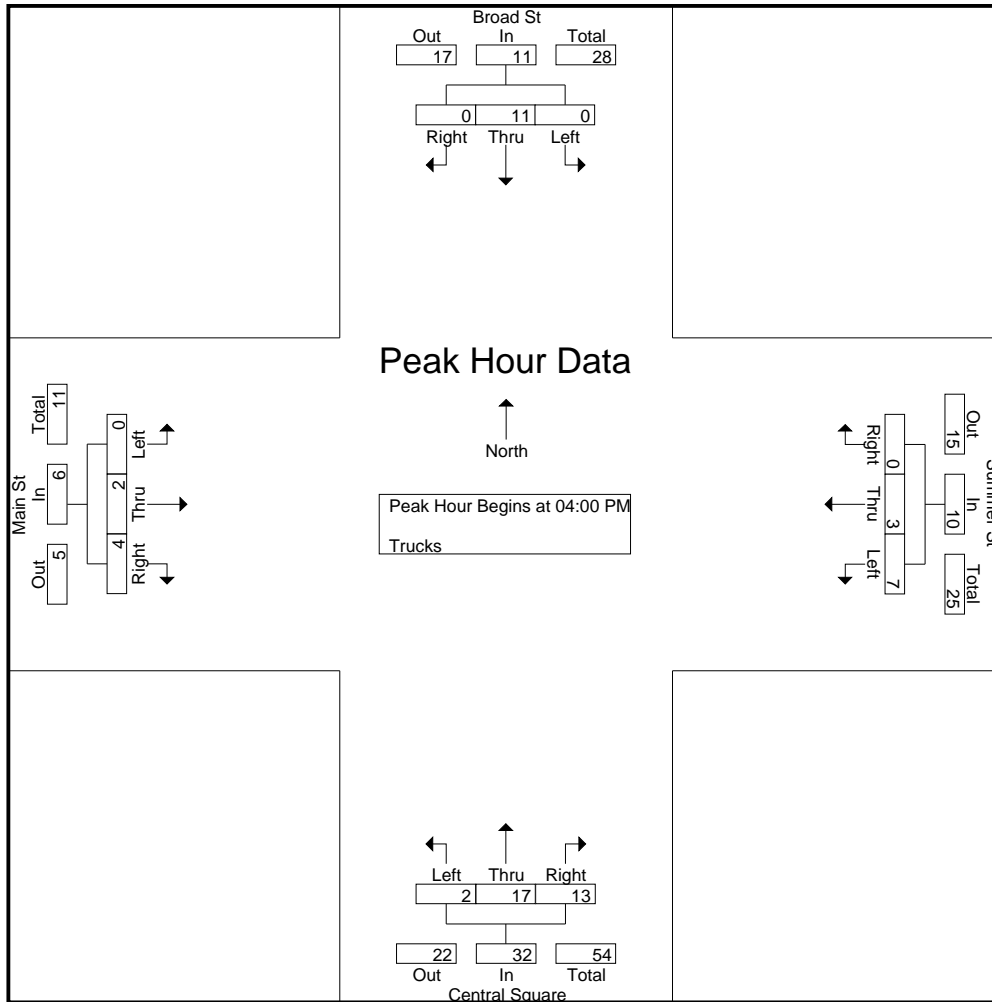

**Peak Hour Analysis From 04:00 PM to 05:45 PM - Peak 1 of 1**

**Peak Hour for Each Approach Begins at:**

	04:00 PM				04:15 PM				04:00 PM				04:00 PM			
+0 mins.	0	2	0	2	<b>4</b>	1	0	<b>5</b>	0	3	3	6	0	1	4	<b>5</b>
+15 mins.	0	<b>4</b>	0	<b>4</b>	1	0	0	1	0	5	<b>4</b>	9	0	1	0	1
+30 mins.	0	3	0	3	2	<b>2</b>	0	4	<b>1</b>	2	4	7	0	0	0	0
+45 mins.	0	2	0	2	1	0	0	1	1	<b>7</b>	2	<b>10</b>	0	0	0	0
Total Volume	0	11	0	11	8	3	0	11	2	17	13	32	0	2	4	6
% App. Total	0	100	0		72.7	27.3	0		6.2	53.1	40.6		0	33.3	66.7	
PHF	.000	.688	.000	.688	.500	.375	.000	.550	.500	.607	.813	.800	.000	.500	.250	.300

# Accurate Counts

978-664-2565

File Name : 20270B13

Site Code : 20270013

Start Date : 10/2/2024

Page No : 9

N/S Street : Broad St / Central Square

E/W Street : Summer St / Main St

City/State : Bridgewater, MA

Weather : Clear

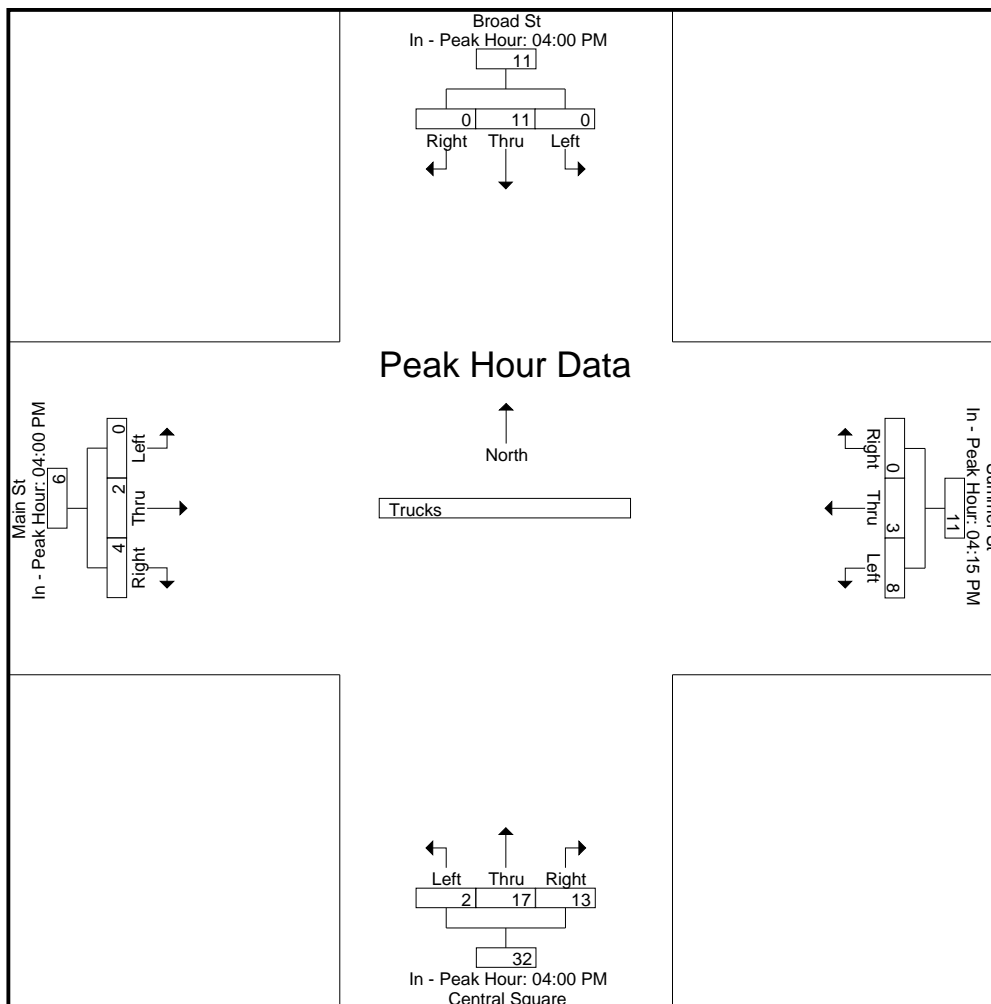

# Accurate Counts

978-664-2565

N/S Street : Broad St / Central Square

E/W Street : Summer St / Main St

City/State : Bridgewater, MA

Weather : Clear

File Name : 20270B13

Site Code : 20270013

Start Date : 10/2/2024

Page No : 10

## Groups Printed- Bikes Peds

Start Time	Broad St From North				Summer St From East				Central Square From South				Main St From West				Exclu. Total	Inclu. Total	Int. Total
	Left	Thru	Right	Peds	Left	Thru	Right	Peds	Left	Thru	Right	Peds	Left	Thru	Right	Peds			
04:00 PM	0	0	0	2	0	0	0	9	0	0	0	0	0	0	0	3	14	0	14
04:15 PM	0	0	0	1	0	0	0	7	0	0	0	6	0	0	0	0	14	0	14
04:30 PM	0	0	0	1	0	0	0	2	0	0	0	0	0	0	0	0	3	0	3
04:45 PM	0	0	0	6	0	0	0	1	0	0	0	0	0	0	0	0	7	0	7
<b>Total</b>	0	0	0	10	0	0	0	19	0	0	0	6	0	0	0	3	38	0	38
05:00 PM	0	0	0	3	0	0	0	0	0	0	0	0	0	0	0	2	5	0	5
05:15 PM	0	0	0	1	0	0	0	0	0	0	0	0	0	0	0	2	3	0	3
05:30 PM	0	0	0	2	0	0	0	3	0	0	0	0	0	0	0	2	7	0	7
05:45 PM	0	0	0	0	0	0	0	0	0	0	0	0	0	0	0	0	0	0	0
<b>Total</b>	0	0	0	6	0	0	0	3	0	0	0	0	0	0	0	6	15	0	15
<b>Grand Total</b>	0	0	0	16	0	0	0	22	0	0	0	6	0	0	0	9	53	0	53
Apprch %	0	0	0		0	0	0		0	0	0		0	0	0				
Total %																	100	0	

Start Time	Broad St From North				Summer St From East				Central Square From South				Main St From West				Int. Total	
	Left	Thru	Right	App. Total	Left	Thru	Right	App. Total	Left	Thru	Right	App. Total	Left	Thru	Right	App. Total		
Peak Hour Analysis From 04:00 PM to 05:45 PM - Peak 1 of 1																		
Peak Hour for Entire Intersection Begins at 04:00 PM																		
04:00 PM	0	0	0	0	0	0	0	0	0	0	0	0	0	0	0	0	0	0
04:15 PM	0	0	0	0	0	0	0	0	0	0	0	0	0	0	0	0	0	0
04:30 PM	0	0	0	0	0	0	0	0	0	0	0	0	0	0	0	0	0	0
04:45 PM	0	0	0	0	0	0	0	0	0	0	0	0	0	0	0	0	0	0
<b>Total Volume</b>	0	0	0	0	0	0	0	0	0	0	0	0	0	0	0	0	0	0
<b>% App. Total</b>	0	0	0		0	0	0		0	0	0		0	0	0			
PHF	.000	.000	.000	.000	.000	.000	.000	.000	.000	.000	.000	.000	.000	.000	.000	.000	.000	.000

# Accurate Counts

978-664-2565

N/S Street : Broad St / Central Square  
 E/W Street : Summer St / Main St  
 City/State : Bridgewater, MA  
 Weather : Clear

File Name : 20270B13  
 Site Code : 20270013  
 Start Date : 10/2/2024  
 Page No : 11

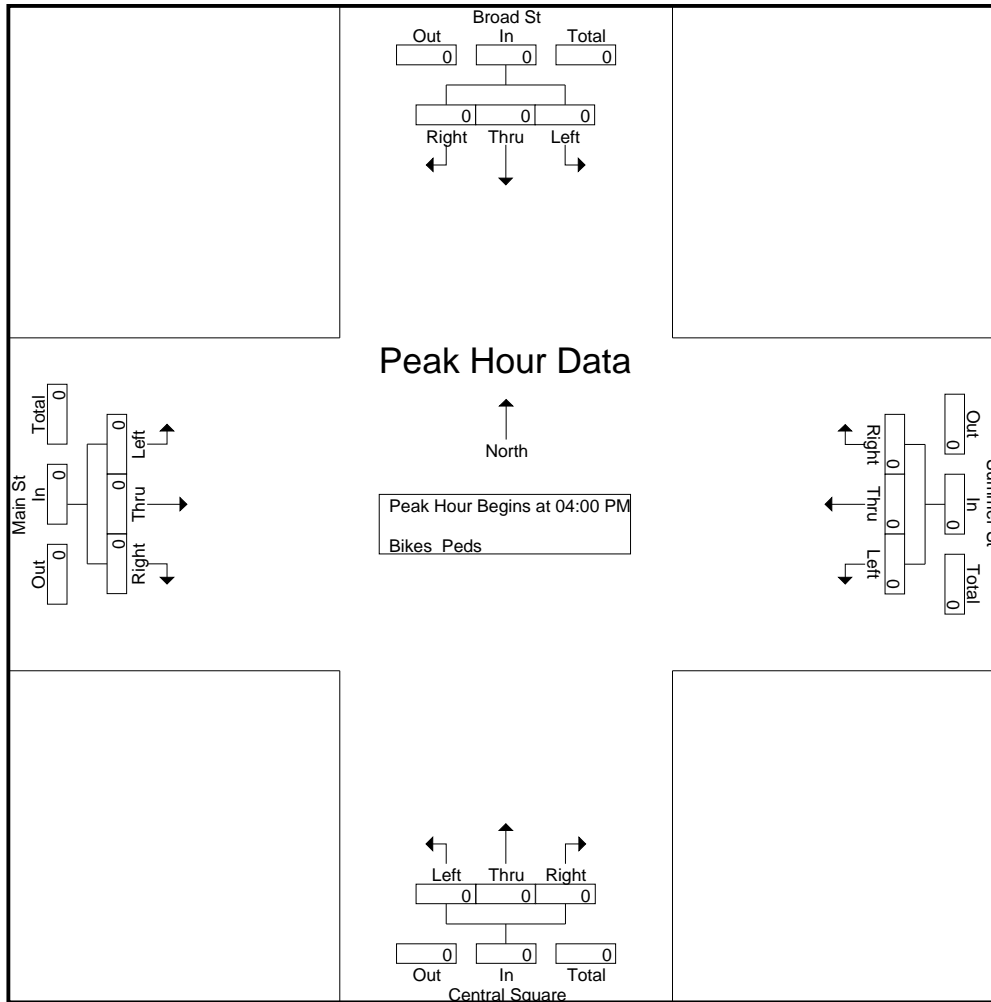

**Peak Hour Analysis From 04:00 PM to 05:45 PM - Peak 1 of 1**

**Peak Hour for Each Approach Begins at:**

	04:00 PM				04:00 PM				04:00 PM				04:00 PM			
+0 mins.	0	0	0	0	0	0	0	0	0	0	0	0	0	0	0	0
+15 mins.	0	0	0	0	0	0	0	0	0	0	0	0	0	0	0	0
+30 mins.	0	0	0	0	0	0	0	0	0	0	0	0	0	0	0	0
+45 mins.	0	0	0	0	0	0	0	0	0	0	0	0	0	0	0	0
Total Volume	0	0	0	0	0	0	0	0	0	0	0	0	0	0	0	0
% App. Total	0	0	0	0	0	0	0	0	0	0	0	0	0	0	0	0
PHF	.000	.000	.000	.000	.000	.000	.000	.000	.000	.000	.000	.000	.000	.000	.000	.000

# Accurate Counts

978-664-2565

File Name : 20270B13

Site Code : 20270013

Start Date : 10/2/2024

Page No : 12

N/S Street : Broad St / Central Square

E/W Street : Summer St / Main St

City/State : Bridgewater, MA

Weather : Clear

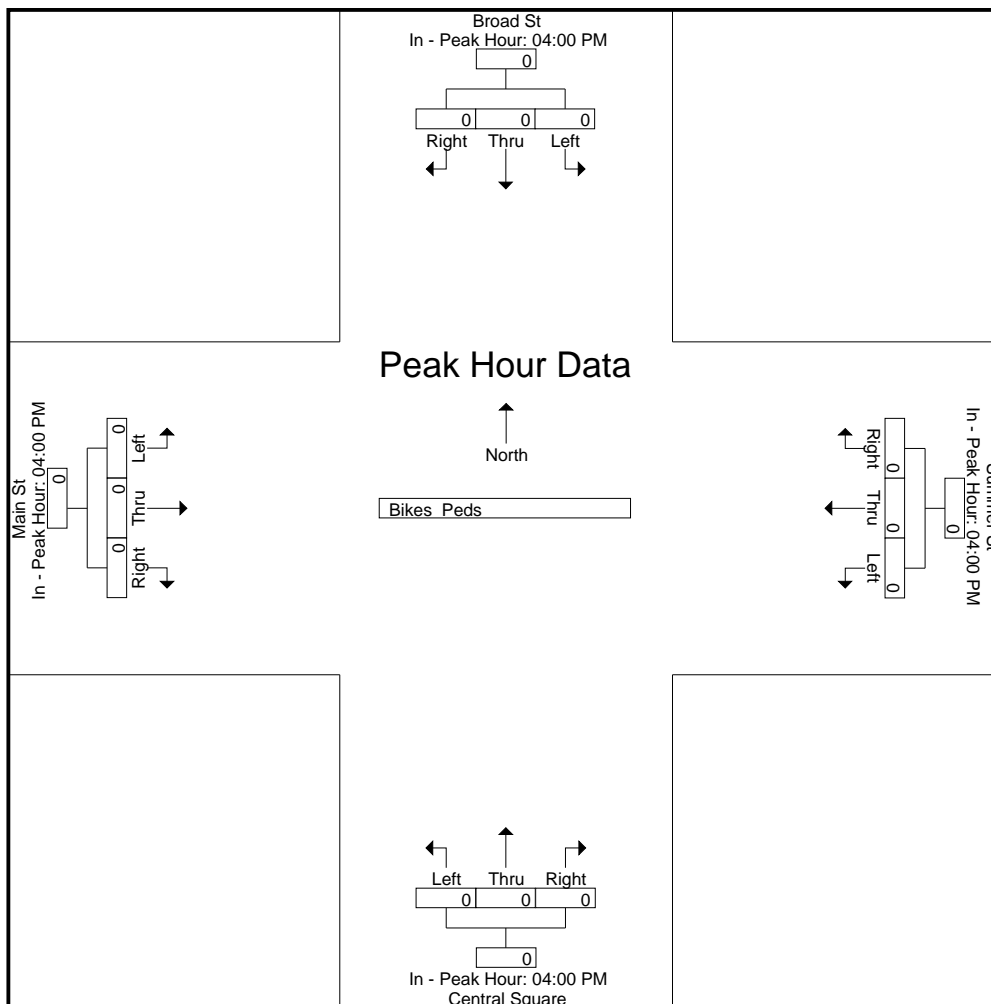



# Accurate Counts

978-664-2565

N/S Street : Summer Street  
 E/W Street : Plymouth St / Summer St  
 City/State : Bridgewater, MA  
 Weather : Clear

File Name : 20270B14  
 Site Code : 20270014  
 Start Date : 10/2/2024  
 Page No : 1

### Groups Printed- Cars - Trucks

Start Time	Plymouth St From East		Summer St From South		Summer St From West		Int. Total
	Left	Thru	Left	Right	Thru	Right	
07:00 AM	9	98	38	13	52	8	218
07:15 AM	7	97	27	17	80	11	239
07:30 AM	11	107	36	26	94	7	281
07:45 AM	24	116	31	22	90	13	296
<b>Total</b>	<b>51</b>	<b>418</b>	<b>132</b>	<b>78</b>	<b>316</b>	<b>39</b>	<b>1034</b>
08:00 AM	14	104	35	24	88	6	271
08:15 AM	22	94	25	15	103	10	269
08:30 AM	17	80	20	24	115	12	268
08:45 AM	29	88	31	41	103	10	302
<b>Total</b>	<b>82</b>	<b>366</b>	<b>111</b>	<b>104</b>	<b>409</b>	<b>38</b>	<b>1110</b>
<b>Grand Total</b>	<b>133</b>	<b>784</b>	<b>243</b>	<b>182</b>	<b>725</b>	<b>77</b>	<b>2144</b>
Apprch %	14.5	85.5	57.2	42.8	90.4	9.6	
Total %	6.2	36.6	11.3	8.5	33.8	3.6	
Cars	118	740	236	170	678	76	2018
% Cars	88.7	94.4	97.1	93.4	93.5	98.7	94.1
Trucks	15	44	7	12	47	1	126
% Trucks	11.3	5.6	2.9	6.6	6.5	1.3	5.9

Start Time	Plymouth St From East			Summer St From South			Summer St From West			Int. Total
	Left	Thru	App. Total	Left	Right	App. Total	Thru	Right	App. Total	
Peak Hour Analysis From 07:00 AM to 08:45 AM - Peak 1 of 1										
Peak Hour for Entire Intersection Begins at 07:30 AM										
07:30 AM	11	107	118	<b>36</b>	<b>26</b>	<b>62</b>	94	7	101	281
07:45 AM	<b>24</b>	<b>116</b>	<b>140</b>	31	22	53	90	<b>13</b>	103	<b>296</b>
08:00 AM	14	104	118	35	24	59	88	6	94	271
08:15 AM	22	94	116	25	15	40	<b>103</b>	10	<b>113</b>	269
<b>Total Volume</b>	<b>71</b>	<b>421</b>	<b>492</b>	<b>127</b>	<b>87</b>	<b>214</b>	<b>375</b>	<b>36</b>	<b>411</b>	<b>1117</b>
% App. Total	14.4	85.6		59.3	40.7		91.2	8.8		
PHF	.740	.907	.879	.882	.837	.863	.910	.692	.909	.943

# Accurate Counts

978-664-2565

N/S Street : Summer Street  
 E/W Street : Plymouth St / Summer St  
 City/State : Bridgewater, MA  
 Weather : Clear

File Name : 20270B14  
 Site Code : 20270014  
 Start Date : 10/2/2024  
 Page No : 2

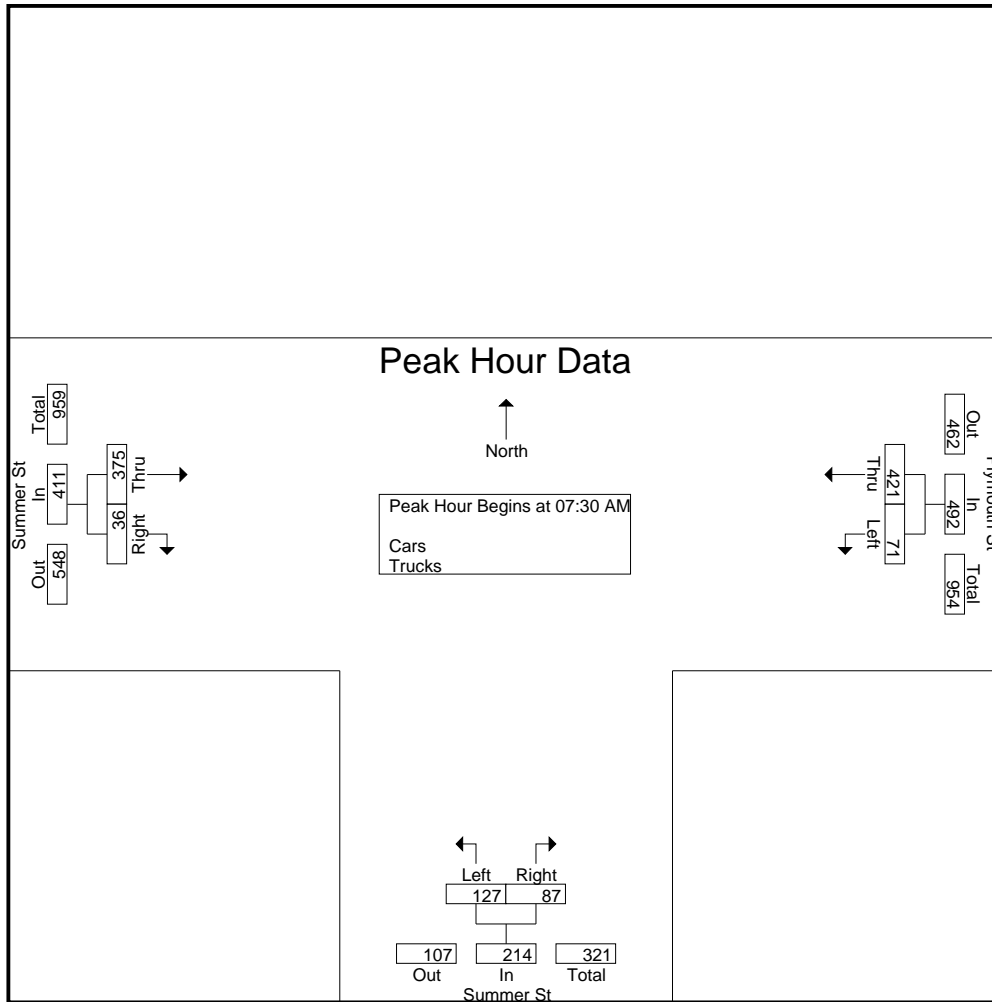

**Peak Hour Analysis From 07:00 AM to 08:45 AM - Peak 1 of 1**

Peak Hour for Each Approach Begins at:

	07:30 AM			07:15 AM			08:00 AM		
+0 mins.	11	107	118	27	17	44	88	6	94
+15 mins.	<b>24</b>	<b>116</b>	<b>140</b>	<b>36</b>	<b>26</b>	<b>62</b>	103	10	113
+30 mins.	14	104	118	31	22	53	<b>115</b>	<b>12</b>	<b>127</b>
+45 mins.	22	94	116	35	24	59	103	10	113
Total Volume	71	421	492	129	89	218	409	38	447
% App. Total	14.4	85.6		59.2	40.8		91.5	8.5	
PHF	.740	.907	.879	.896	.856	.879	.889	.792	.880

# Accurate Counts

978-664-2565

File Name : 20270B14

Site Code : 20270014

Start Date : 10/2/2024

Page No : 3

N/S Street : Summer Street  
E/W Street : Plymouth St / Summer St  
City/State : Bridgewater, MA  
Weather : Clear

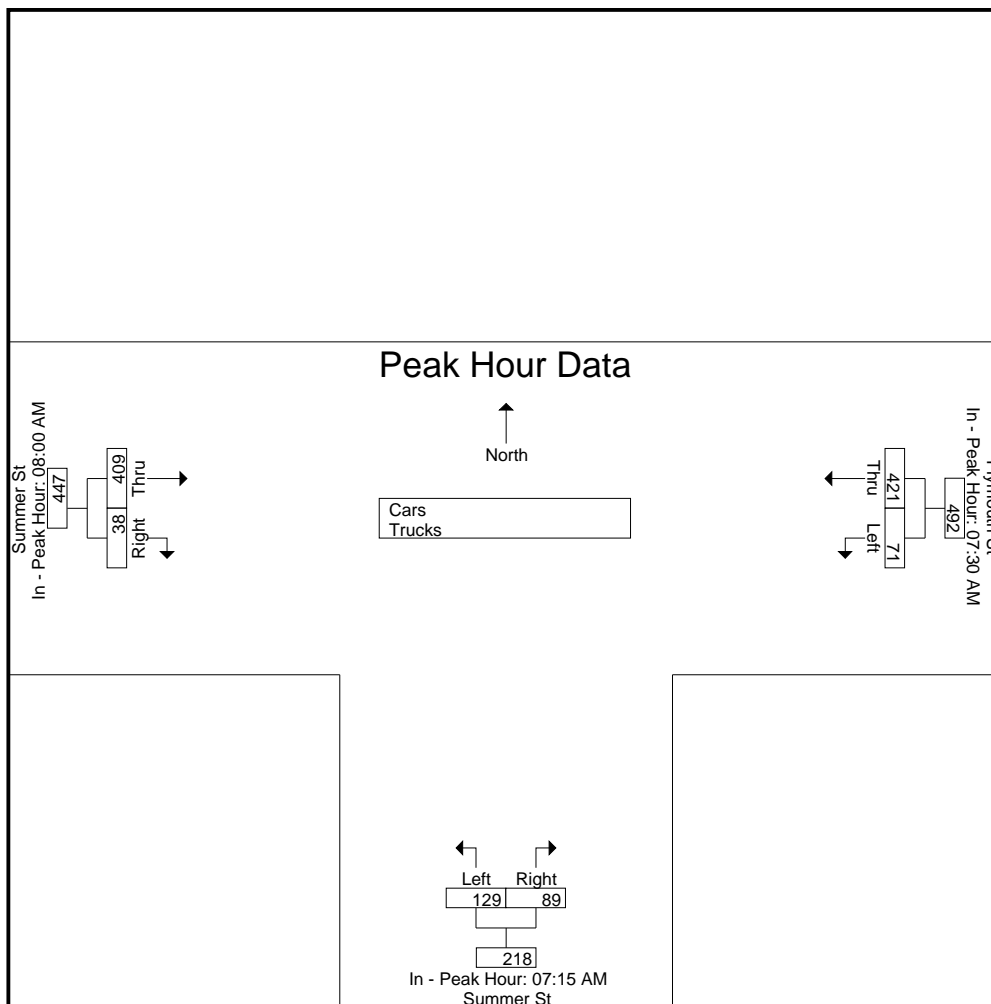

# Accurate Counts

978-664-2565

N/S Street : Summer Street  
 E/W Street : Plymouth St / Summer St  
 City/State : Bridgewater, MA  
 Weather : Clear

File Name : 20270B14  
 Site Code : 20270014  
 Start Date : 10/2/2024  
 Page No : 4

## Groups Printed- Cars

Start Time	Plymouth St From East		Summer St From South		Summer St From West		Int. Total
	Left	Thru	Left	Right	Thru	Right	
07:00 AM	7	92	37	12	47	8	203
07:15 AM	5	96	26	16	77	11	231
07:30 AM	10	103	36	25	87	6	267
07:45 AM	23	110	30	20	86	13	282
<b>Total</b>	<b>45</b>	<b>401</b>	<b>129</b>	<b>73</b>	<b>297</b>	<b>38</b>	<b>983</b>
08:00 AM	12	95	34	22	84	6	253
08:15 AM	20	89	25	14	97	10	255
08:30 AM	16	76	19	21	102	12	246
08:45 AM	25	79	29	40	98	10	281
<b>Total</b>	<b>73</b>	<b>339</b>	<b>107</b>	<b>97</b>	<b>381</b>	<b>38</b>	<b>1035</b>
<b>Grand Total</b>	<b>118</b>	<b>740</b>	<b>236</b>	<b>170</b>	<b>678</b>	<b>76</b>	<b>2018</b>
Apprch %	13.8	86.2	58.1	41.9	89.9	10.1	
Total %	5.8	36.7	11.7	8.4	33.6	3.8	

Start Time	Plymouth St From East			Summer St From South			Summer St From West			Int. Total
	Left	Thru	App. Total	Left	Right	App. Total	Thru	Right	App. Total	
Peak Hour Analysis From 07:00 AM to 08:45 AM - Peak 1 of 1										
Peak Hour for Entire Intersection Begins at 07:30 AM										
07:30 AM	10	103	113	<b>36</b>	<b>25</b>	<b>61</b>	87	6	93	267
07:45 AM	<b>23</b>	<b>110</b>	<b>133</b>	30	20	50	86	<b>13</b>	99	<b>282</b>
08:00 AM	12	95	107	34	22	56	84	6	90	253
08:15 AM	20	89	109	25	14	39	<b>97</b>	10	<b>107</b>	255
Total Volume	65	397	462	125	81	206	354	35	389	1057
% App. Total	14.1	85.9		60.7	39.3		91	9		
PHF	.707	.902	.868	.868	.810	.844	.912	.673	.909	.937

# Accurate Counts

978-664-2565

N/S Street : Summer Street  
 E/W Street : Plymouth St / Summer St  
 City/State : Bridgewater, MA  
 Weather : Clear

File Name : 20270B14  
 Site Code : 20270014  
 Start Date : 10/2/2024  
 Page No : 5

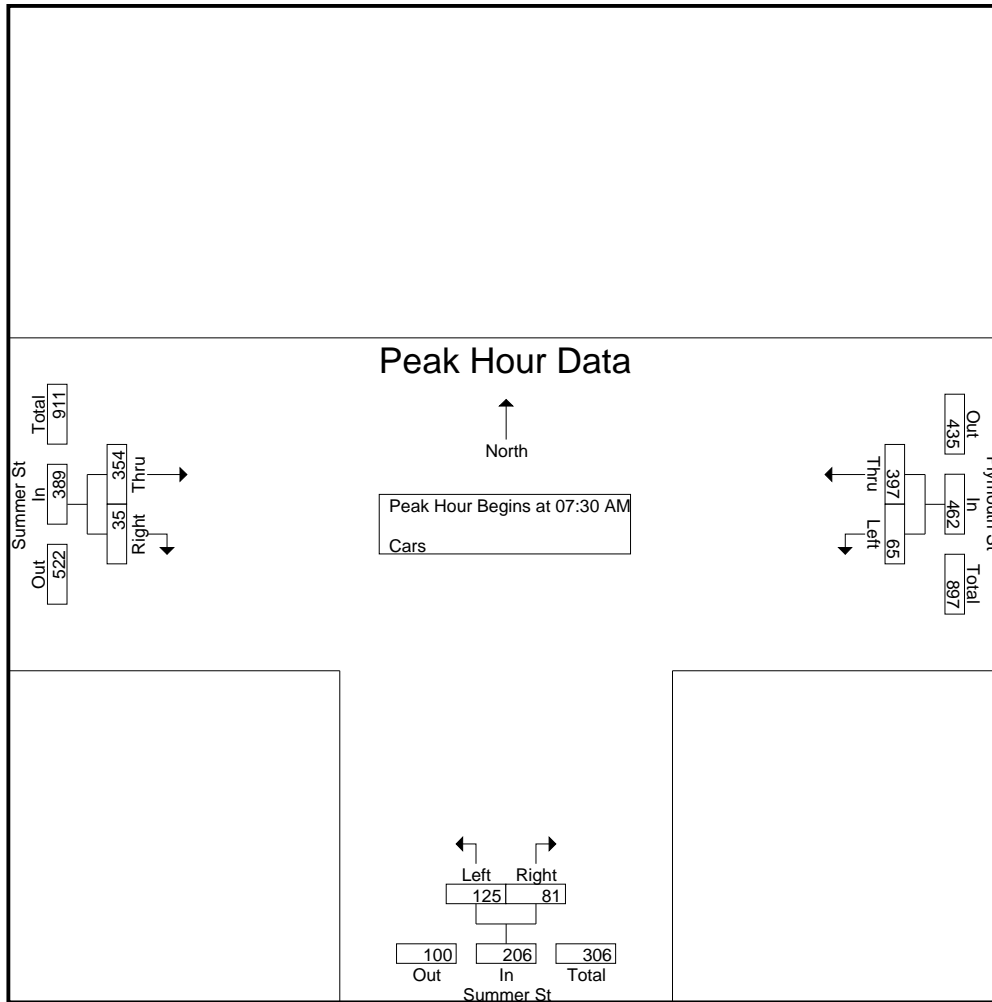

Peak Hour Analysis From 07:00 AM to 08:45 AM - Peak 1 of 1

Peak Hour for Each Approach Begins at:

	07:30 AM			07:15 AM			08:00 AM		
+0 mins.	10	103	113	26	16	42	84	6	90
+15 mins.	23	110	133	36	25	61	97	10	107
+30 mins.	12	95	107	30	20	50	102	12	114
+45 mins.	20	89	109	34	22	56	98	10	108
Total Volume	65	397	462	126	83	209	381	38	419
% App. Total	14.1	85.9		60.3	39.7		90.9	9.1	
PHF	.707	.902	.868	.875	.830	.857	.934	.792	.919

# Accurate Counts

978-664-2565

File Name : 20270B14

Site Code : 20270014

Start Date : 10/2/2024

Page No : 6

N/S Street : Summer Street  
E/W Street : Plymouth St / Summer St  
City/State : Bridgewater, MA  
Weather : Clear

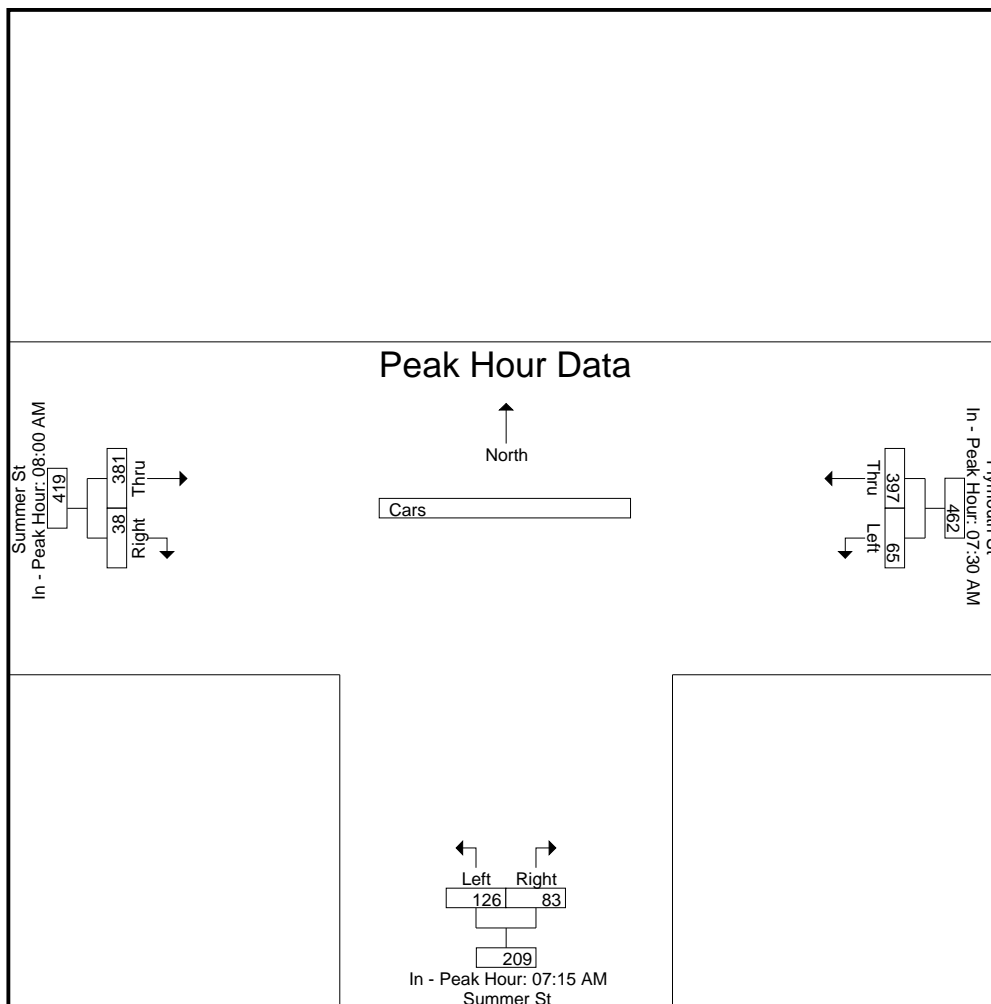

# Accurate Counts

978-664-2565

N/S Street : Summer Street  
 E/W Street : Plymouth St / Summer St  
 City/State : Bridgewater, MA  
 Weather : Clear

File Name : 20270B14  
 Site Code : 20270014  
 Start Date : 10/2/2024  
 Page No : 7

### Groups Printed- Trucks

Start Time	Plymouth St From East		Summer St From South		Summer St From West		Int. Total
	Left	Thru	Left	Right	Thru	Right	
07:00 AM	2	6	1	1	5	0	15
07:15 AM	2	1	1	1	3	0	8
07:30 AM	1	4	0	1	7	1	14
07:45 AM	1	6	1	2	4	0	14
<b>Total</b>	<b>6</b>	<b>17</b>	<b>3</b>	<b>5</b>	<b>19</b>	<b>1</b>	<b>51</b>
08:00 AM	2	9	1	2	4	0	18
08:15 AM	2	5	0	1	6	0	14
08:30 AM	1	4	1	3	13	0	22
08:45 AM	4	9	2	1	5	0	21
<b>Total</b>	<b>9</b>	<b>27</b>	<b>4</b>	<b>7</b>	<b>28</b>	<b>0</b>	<b>75</b>
<b>Grand Total</b>	<b>15</b>	<b>44</b>	<b>7</b>	<b>12</b>	<b>47</b>	<b>1</b>	<b>126</b>
Apprch %	25.4	74.6	36.8	63.2	97.9	2.1	
Total %	11.9	34.9	5.6	9.5	37.3	0.8	

Start Time	Plymouth St From East			Summer St From South			Summer St From West			Int. Total
	Left	Thru	App. Total	Left	Right	App. Total	Thru	Right	App. Total	
Peak Hour Analysis From 07:00 AM to 08:45 AM - Peak 1 of 1										
Peak Hour for Entire Intersection Begins at 08:00 AM										
08:00 AM	2	<b>9</b>	11	1	2	3	4	0	4	18
08:15 AM	2	5	7	0	1	1	6	0	6	14
08:30 AM	1	4	5	1	<b>3</b>	<b>4</b>	<b>13</b>	0	<b>13</b>	<b>22</b>
08:45 AM	<b>4</b>	9	<b>13</b>	<b>2</b>	1	3	5	0	5	21
Total Volume	9	27	36	4	7	11	28	0	28	75
% App. Total	25	75		36.4	63.6		100	0		
PHF	.563	.750	.692	.500	.583	.688	.538	.000	.538	.852

# Accurate Counts

978-664-2565

N/S Street : Summer Street  
 E/W Street : Plymouth St / Summer St  
 City/State : Bridgewater, MA  
 Weather : Clear

File Name : 20270B14  
 Site Code : 20270014  
 Start Date : 10/2/2024  
 Page No : 8

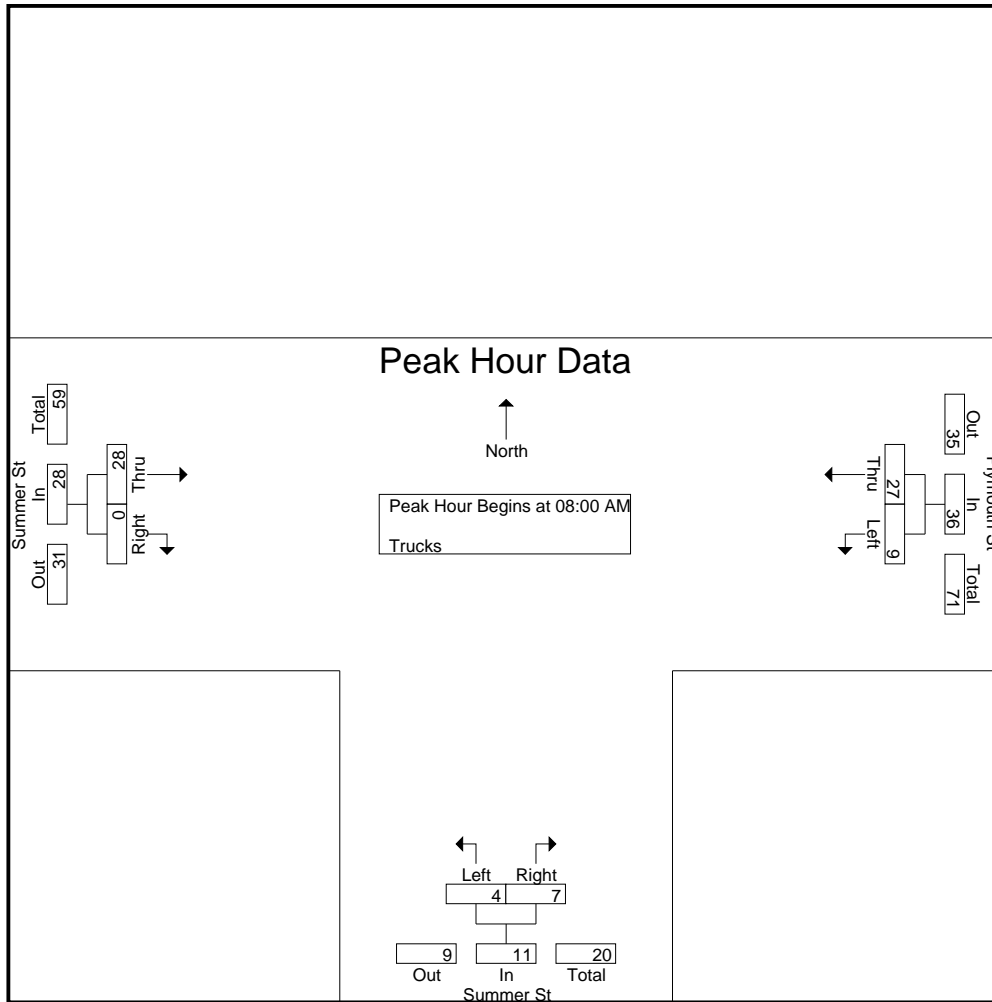

**Peak Hour Analysis From 07:00 AM to 08:45 AM - Peak 1 of 1**

Peak Hour for Each Approach Begins at:

	08:00 AM			07:45 AM			08:00 AM		
+0 mins.	2	9	11	1	2	3	4	0	4
+15 mins.	2	5	7	1	2	3	6	0	6
+30 mins.	1	4	5	0	1	1	13	0	13
+45 mins.	4	9	13	1	3	4	5	0	5
Total Volume	9	27	36	3	8	11	28	0	28
% App. Total	25	75		27.3	72.7		100	0	
PHF	.563	.750	.692	.750	.667	.688	.538	.000	.538



# Accurate Counts

978-664-2565

File Name : 20270B14

Site Code : 20270014

Start Date : 10/2/2024

Page No : 9

N/S Street : Summer Street  
E/W Street : Plymouth St / Summer St  
City/State : Bridgewater, MA  
Weather : Clear

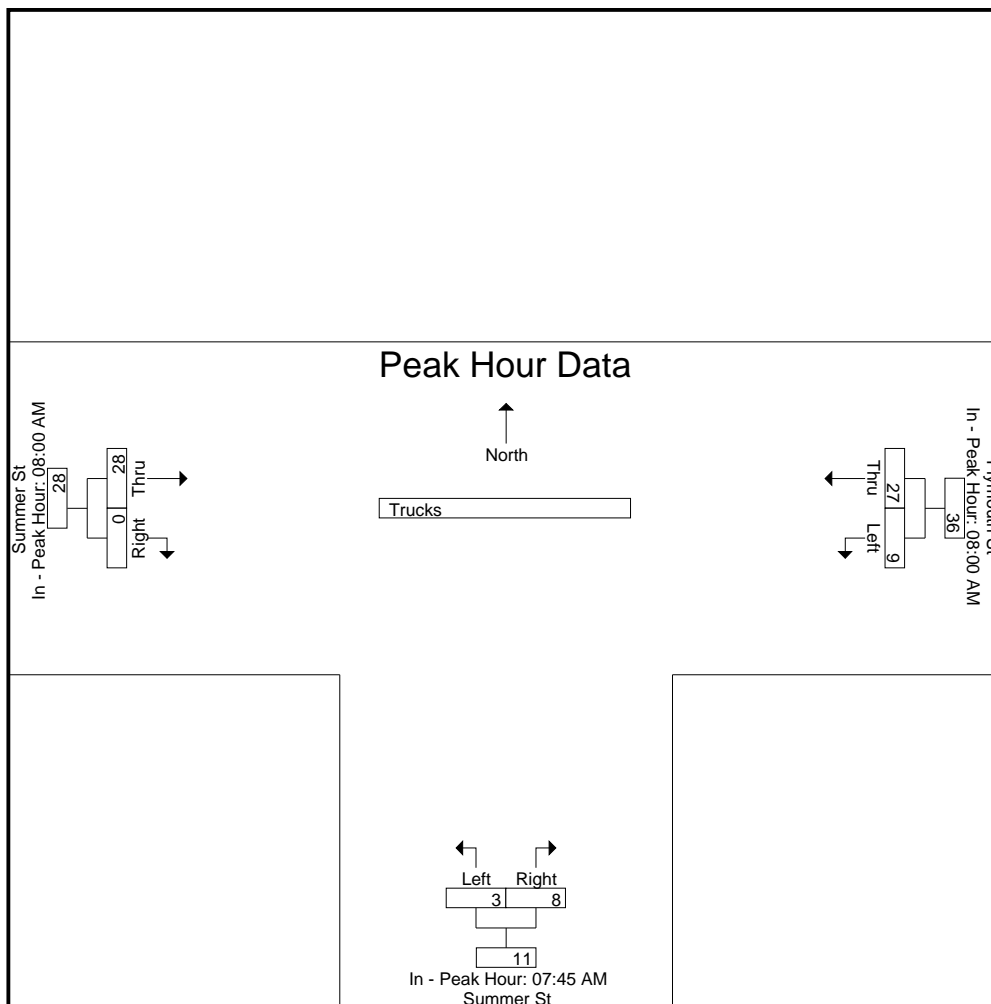



# Accurate Counts

978-664-2565

N/S Street : Summer Street  
 E/W Street : Plymouth St / Summer St  
 City/State : Bridgewater, MA  
 Weather : Clear

File Name : 20270B14  
 Site Code : 20270014  
 Start Date : 10/2/2024  
 Page No : 11

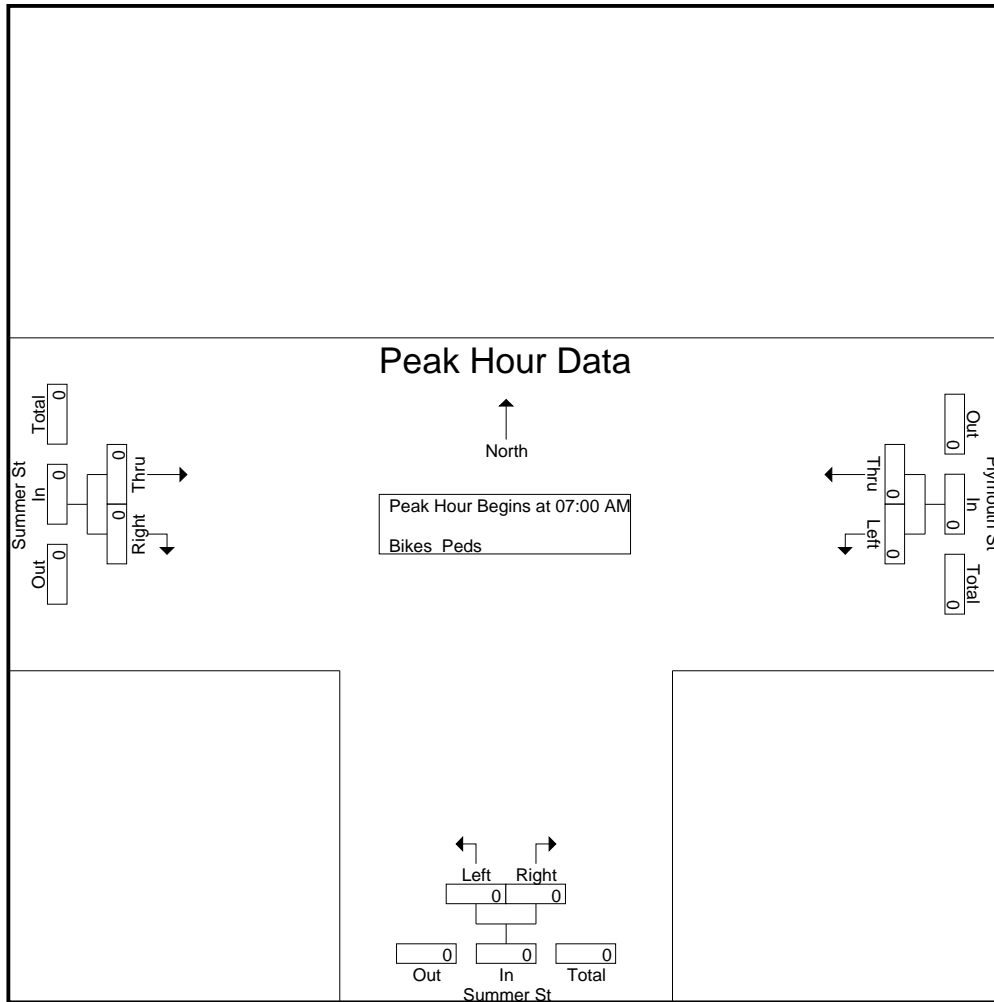

**Peak Hour Analysis From 07:00 AM to 08:45 AM - Peak 1 of 1**

Peak Hour for Each Approach Begins at:

	07:00 AM			07:00 AM			07:00 AM		
+0 mins.	0	0	0	0	0	0	0	0	0
+15 mins.	0	0	0	0	0	0	0	0	0
+30 mins.	0	0	0	0	0	0	0	0	0
+45 mins.	0	0	0	0	0	0	0	0	0
Total Volume	0	0	0	0	0	0	0	0	0
% App. Total	0	0	0	0	0	0	0	0	0
PHF	.000	.000	.000	.000	.000	.000	.000	.000	.000

# Accurate Counts

978-664-2565

File Name : 20270B14

Site Code : 20270014

Start Date : 10/2/2024

Page No : 12

N/S Street : Summer Street  
E/W Street : Plymouth St / Summer St  
City/State : Bridgewater, MA  
Weather : Clear

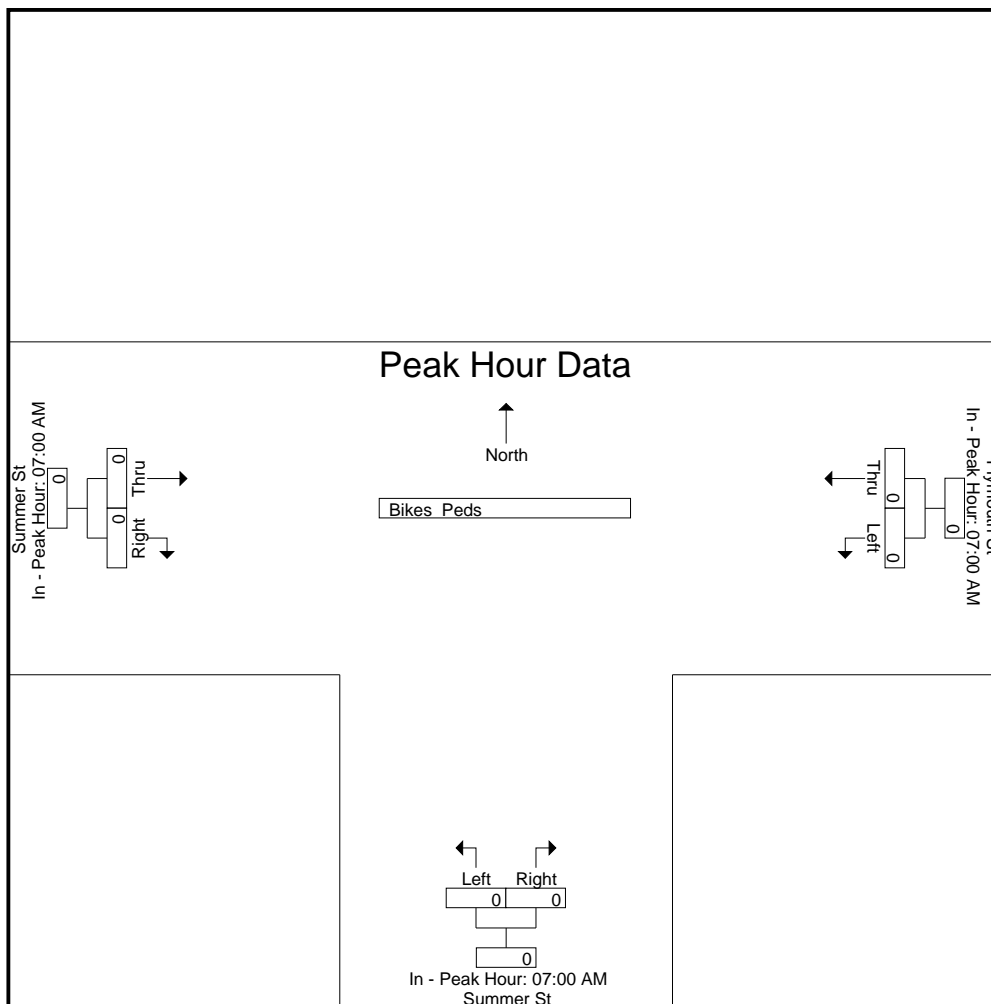

# Accurate Counts

978-664-2565

N/S Street : Summer Street  
 E/W Street : Plymouth St / Summer St  
 City/State : Bridgewater, MA  
 Weather : Clear

File Name : 20270B14  
 Site Code : 20270014  
 Start Date : 10/2/2024  
 Page No : 1

### Groups Printed- Cars - Trucks

Start Time	Plymouth St From East		Summer St From South		Summer St From West		Int. Total
	Left	Thru	Left	Right	Thru	Right	
04:00 PM	23	107	42	51	107	12	342
04:15 PM	44	94	44	31	101	21	335
04:30 PM	49	112	49	45	117	12	384
04:45 PM	39	104	46	43	129	16	377
<b>Total</b>	<b>155</b>	<b>417</b>	<b>181</b>	<b>170</b>	<b>454</b>	<b>61</b>	<b>1438</b>
05:00 PM	35	111	48	41	129	11	375
05:15 PM	31	132	46	34	103	18	364
05:30 PM	33	116	47	31	111	18	356
05:45 PM	36	135	35	28	121	13	368
<b>Total</b>	<b>135</b>	<b>494</b>	<b>176</b>	<b>134</b>	<b>464</b>	<b>60</b>	<b>1463</b>
<b>Grand Total</b>	<b>290</b>	<b>911</b>	<b>357</b>	<b>304</b>	<b>918</b>	<b>121</b>	<b>2901</b>
Apprch %	24.1	75.9	54	46	88.4	11.6	
Total %	10	31.4	12.3	10.5	31.6	4.2	
Cars	263	899	356	280	902	121	2821
% Cars	90.7	98.7	99.7	92.1	98.3	100	97.2
Trucks	27	12	1	24	16	0	80
% Trucks	9.3	1.3	0.3	7.9	1.7	0	2.8

Start Time	Plymouth St From East			Summer St From South			Summer St From West			Int. Total
	Left	Thru	App. Total	Left	Right	App. Total	Thru	Right	App. Total	
Peak Hour Analysis From 04:00 PM to 05:45 PM - Peak 1 of 1										
Peak Hour for Entire Intersection Begins at 04:30 PM										
04:30 PM	<b>49</b>	112	161	<b>49</b>	<b>45</b>	<b>94</b>	117	12	129	<b>384</b>
04:45 PM	39	104	143	46	43	89	<b>129</b>	16	<b>145</b>	377
05:00 PM	35	111	146	48	41	89	129	11	140	375
05:15 PM	31	<b>132</b>	<b>163</b>	46	34	80	103	<b>18</b>	121	364
<b>Total Volume</b>	<b>154</b>	<b>459</b>	<b>613</b>	<b>189</b>	<b>163</b>	<b>352</b>	<b>478</b>	<b>57</b>	<b>535</b>	<b>1500</b>
% App. Total	25.1	74.9		53.7	46.3		89.3	10.7		
PHF	.786	.869	.940	.964	.906	.936	.926	.792	.922	.977

# Accurate Counts

978-664-2565

N/S Street : Summer Street  
 E/W Street : Plymouth St / Summer St  
 City/State : Bridgewater, MA  
 Weather : Clear

File Name : 20270B14  
 Site Code : 20270014  
 Start Date : 10/2/2024  
 Page No : 2

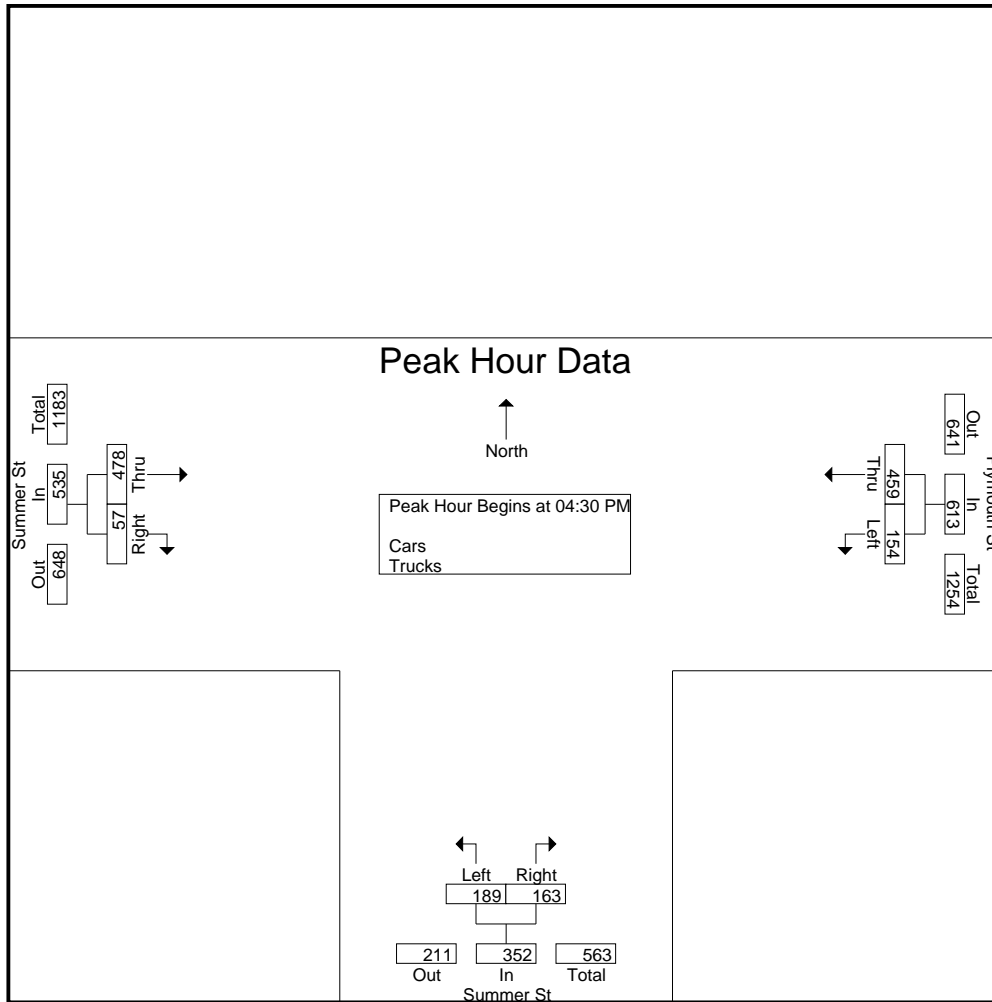

Peak Hour Analysis From 04:00 PM to 05:45 PM - Peak 1 of 1

Peak Hour for Each Approach Begins at:

	05:00 PM			04:30 PM			04:15 PM		
+0 mins.	35	111	146	<b>49</b>	<b>45</b>	<b>94</b>	101	<b>21</b>	122
+15 mins.	31	132	163	46	43	89	117	12	129
+30 mins.	33	116	149	48	41	89	<b>129</b>	16	<b>145</b>
+45 mins.	<b>36</b>	<b>135</b>	<b>171</b>	46	34	80	129	11	140
Total Volume	135	494	629	189	163	352	476	60	536
% App. Total	21.5	78.5		53.7	46.3		88.8	11.2	
PHF	.938	.915	.920	.964	.906	.936	.922	.714	.924

# Accurate Counts

978-664-2565

File Name : 20270B14

Site Code : 20270014

Start Date : 10/2/2024

Page No : 3

N/S Street : Summer Street  
E/W Street : Plymouth St / Summer St  
City/State : Bridgewater, MA  
Weather : Clear

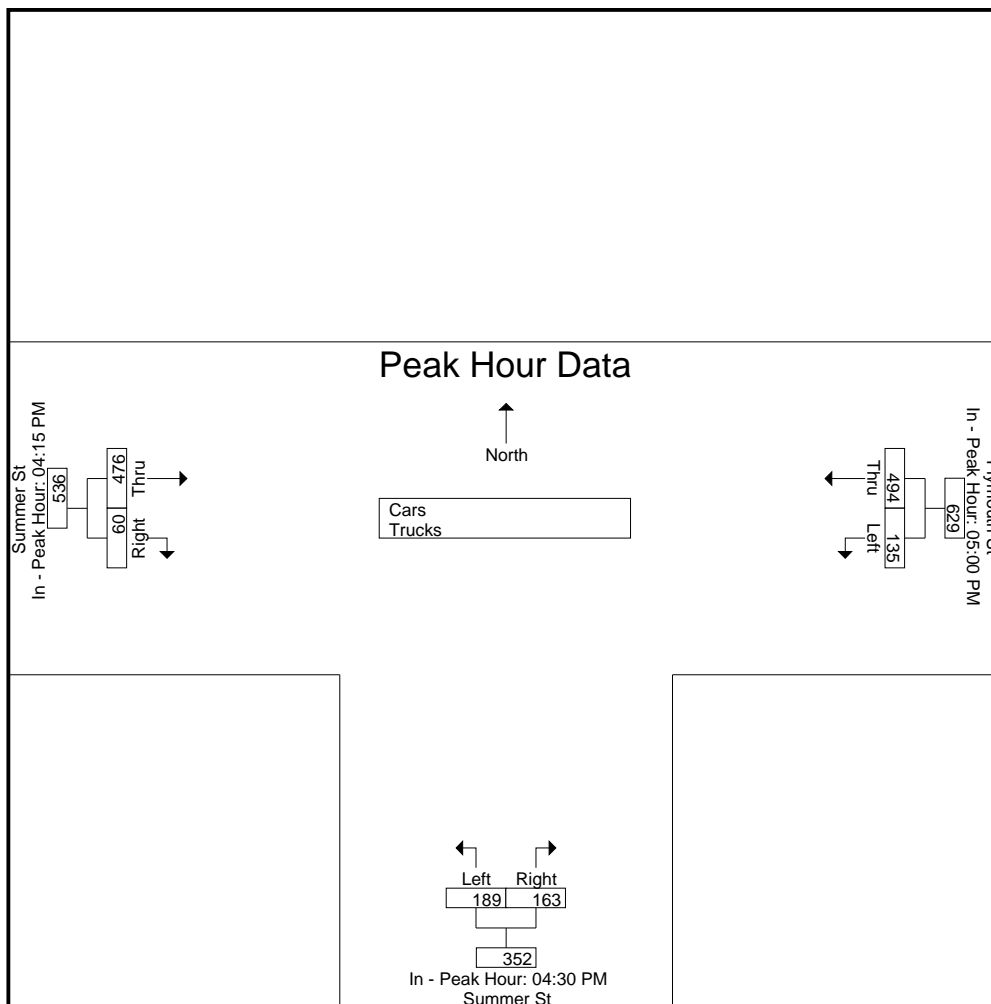

# Accurate Counts

978-664-2565

N/S Street : Summer Street  
 E/W Street : Plymouth St / Summer St  
 City/State : Bridgewater, MA  
 Weather : Clear

File Name : 20270B14  
 Site Code : 20270014  
 Start Date : 10/2/2024  
 Page No : 4

## Groups Printed- Cars

Start Time	Plymouth St From East		Summer St From South		Summer St From West		Int. Total
	Left	Thru	Left	Right	Thru	Right	
04:00 PM	19	105	42	46	103	12	327
04:15 PM	40	88	44	27	97	21	317
04:30 PM	45	111	49	43	113	12	373
04:45 PM	37	102	46	37	127	16	365
<b>Total</b>	<b>141</b>	<b>406</b>	<b>181</b>	<b>153</b>	<b>440</b>	<b>61</b>	<b>1382</b>
05:00 PM	27	110	48	39	129	11	364
05:15 PM	28	132	46	32	102	18	358
05:30 PM	32	116	46	29	110	18	351
05:45 PM	35	135	35	27	121	13	366
<b>Total</b>	<b>122</b>	<b>493</b>	<b>175</b>	<b>127</b>	<b>462</b>	<b>60</b>	<b>1439</b>
<b>Grand Total</b>	<b>263</b>	<b>899</b>	<b>356</b>	<b>280</b>	<b>902</b>	<b>121</b>	<b>2821</b>
Apprch %	22.6	77.4	56	44	88.2	11.8	
Total %	9.3	31.9	12.6	9.9	32	4.3	

Start Time	Plymouth St From East			Summer St From South			Summer St From West			Int. Total
	Left	Thru	App. Total	Left	Right	App. Total	Thru	Right	App. Total	
Peak Hour Analysis From 04:00 PM to 05:45 PM - Peak 1 of 1										
Peak Hour for Entire Intersection Begins at 04:30 PM										
04:30 PM	<b>45</b>	111	156	<b>49</b>	<b>43</b>	<b>92</b>	113	12	125	<b>373</b>
04:45 PM	37	102	139	46	37	83	127	16	<b>143</b>	365
05:00 PM	27	110	137	48	39	87	<b>129</b>	11	140	364
05:15 PM	28	<b>132</b>	<b>160</b>	46	32	78	102	<b>18</b>	120	358
Total Volume	137	455	592	189	151	340	471	57	528	1460
% App. Total	23.1	76.9		55.6	44.4		89.2	10.8		
PHF	.761	.862	.925	.964	.878	.924	.913	.792	.923	.979



# Accurate Counts

978-664-2565

N/S Street : Summer Street  
 E/W Street : Plymouth St / Summer St  
 City/State : Bridgewater, MA  
 Weather : Clear

File Name : 20270B14  
 Site Code : 20270014  
 Start Date : 10/2/2024  
 Page No : 5

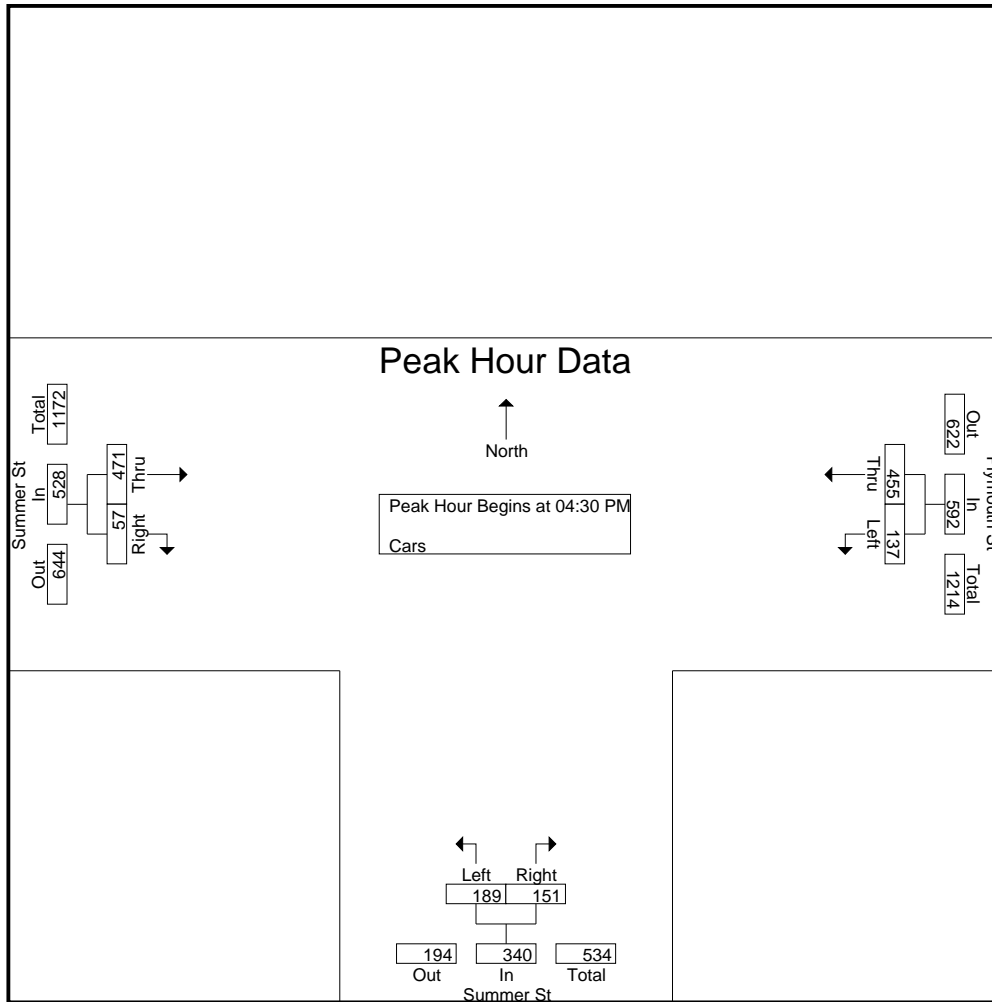

Peak Hour Analysis From 04:00 PM to 05:45 PM - Peak 1 of 1

Peak Hour for Each Approach Begins at:

	05:00 PM			04:30 PM			04:45 PM		
+0 mins.	27	110	137	<b>49</b>	<b>43</b>	<b>92</b>	127	16	<b>143</b>
+15 mins.	28	132	160	46	37	83	<b>129</b>	11	140
+30 mins.	32	116	148	48	39	87	102	<b>18</b>	120
+45 mins.	<b>35</b>	<b>135</b>	<b>170</b>	46	32	78	110	18	128
Total Volume	122	493	615	189	151	340	468	63	531
% App. Total	19.8	80.2		55.6	44.4		88.1	11.9	
PHF	.871	.913	.904	.964	.878	.924	.907	.875	.928

# Accurate Counts

978-664-2565

File Name : 20270B14

Site Code : 20270014

Start Date : 10/2/2024

Page No : 6

N/S Street : Summer Street  
E/W Street : Plymouth St / Summer St  
City/State : Bridgewater, MA  
Weather : Clear

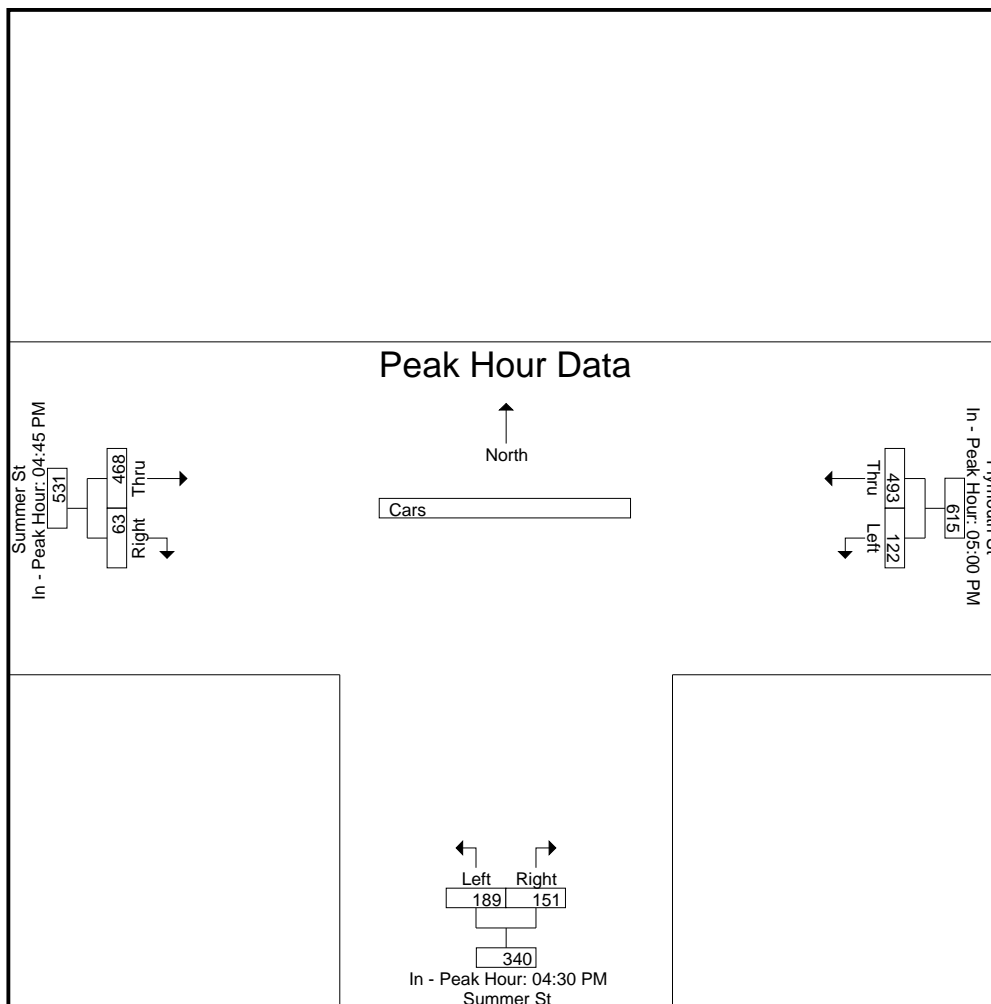

# Accurate Counts

978-664-2565

N/S Street : Summer Street  
 E/W Street : Plymouth St / Summer St  
 City/State : Bridgewater, MA  
 Weather : Clear

File Name : 20270B14  
 Site Code : 20270014  
 Start Date : 10/2/2024  
 Page No : 7

### Groups Printed- Trucks

Start Time	Plymouth St From East		Summer St From South		Summer St From West		Int. Total
	Left	Thru	Left	Right	Thru	Right	
04:00 PM	4	2	0	5	4	0	15
04:15 PM	4	6	0	4	4	0	18
04:30 PM	4	1	0	2	4	0	11
04:45 PM	2	2	0	6	2	0	12
<b>Total</b>	<b>14</b>	<b>11</b>	<b>0</b>	<b>17</b>	<b>14</b>	<b>0</b>	<b>56</b>
05:00 PM	8	1	0	2	0	0	11
05:15 PM	3	0	0	2	1	0	6
05:30 PM	1	0	1	2	1	0	5
05:45 PM	1	0	0	1	0	0	2
<b>Total</b>	<b>13</b>	<b>1</b>	<b>1</b>	<b>7</b>	<b>2</b>	<b>0</b>	<b>24</b>
<b>Grand Total</b>	<b>27</b>	<b>12</b>	<b>1</b>	<b>24</b>	<b>16</b>	<b>0</b>	<b>80</b>
Apprch %	69.2	30.8	4	96	100	0	
Total %	33.8	15	1.2	30	20	0	

Start Time	Plymouth St From East			Summer St From South			Summer St From West			Int. Total
	Left	Thru	App. Total	Left	Right	App. Total	Thru	Right	App. Total	
Peak Hour Analysis From 04:00 PM to 05:45 PM - Peak 1 of 1										
Peak Hour for Entire Intersection Begins at 04:00 PM										
04:00 PM	4	2	6	0	5	5	4	0	4	15
04:15 PM	4	6	10	0	4	4	4	0	4	18
04:30 PM	4	1	5	0	2	2	4	0	4	11
04:45 PM	2	2	4	0	6	6	2	0	2	12
<b>Total Volume</b>	<b>14</b>	<b>11</b>	<b>25</b>	<b>0</b>	<b>17</b>	<b>17</b>	<b>14</b>	<b>0</b>	<b>14</b>	<b>56</b>
<b>% App. Total</b>	<b>56</b>	<b>44</b>		<b>0</b>	<b>100</b>		<b>100</b>	<b>0</b>		
PHF	.875	.458	.625	.000	.708	.708	.875	.000	.875	.778

# Accurate Counts

978-664-2565

N/S Street : Summer Street  
 E/W Street : Plymouth St / Summer St  
 City/State : Bridgewater, MA  
 Weather : Clear

File Name : 20270B14  
 Site Code : 20270014  
 Start Date : 10/2/2024  
 Page No : 8

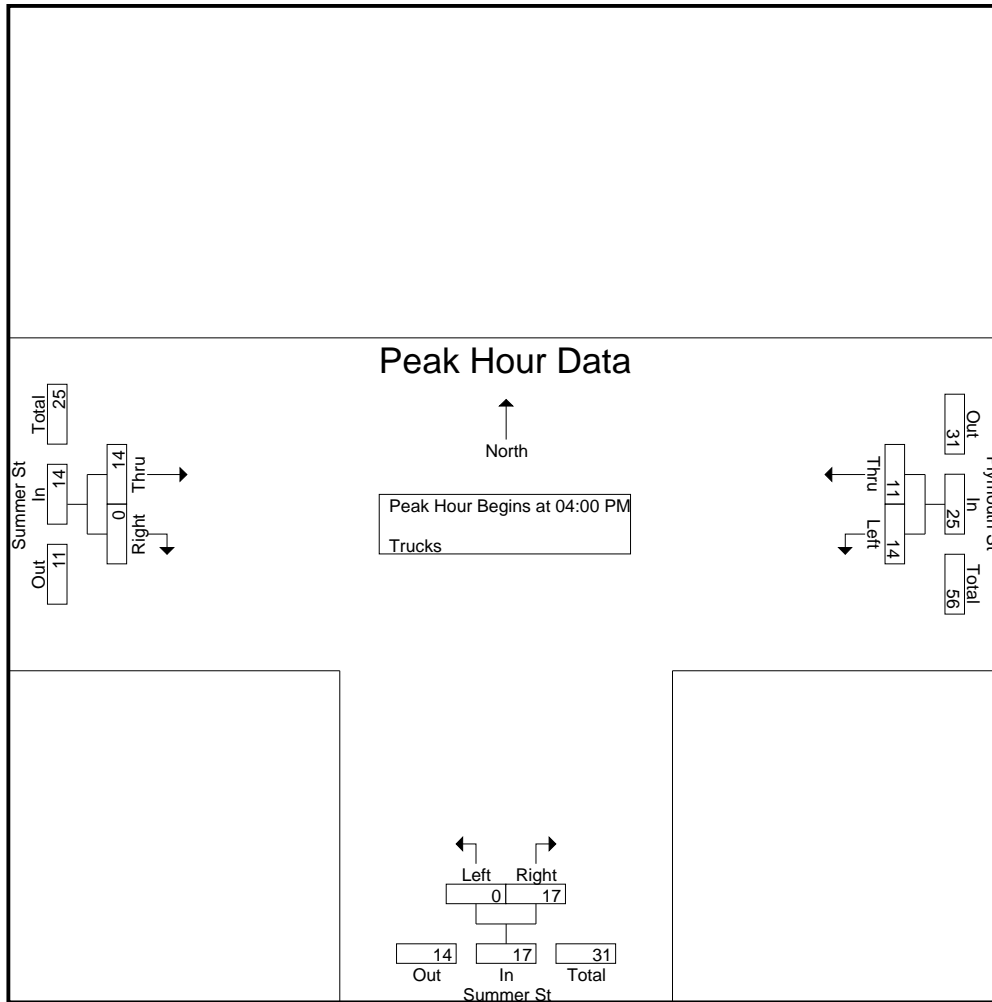

Peak Hour Analysis From 04:00 PM to 05:45 PM - Peak 1 of 1

Peak Hour for Each Approach Begins at:

	04:15 PM			04:00 PM			04:00 PM		
+0 mins.	4	6	10	0	5	5	4	0	4
+15 mins.	4	1	5	0	4	4	4	0	4
+30 mins.	2	2	4	0	2	2	4	0	4
+45 mins.	8	1	9	0	6	6	2	0	2
Total Volume	18	10	28	0	17	17	14	0	14
% App. Total	64.3	35.7		0	100		100	0	
PHF	.563	.417	.700	.000	.708	.708	.875	.000	.875

# Accurate Counts

978-664-2565

File Name : 20270B14

Site Code : 20270014

Start Date : 10/2/2024

Page No : 9

N/S Street : Summer Street  
E/W Street : Plymouth St / Summer St  
City/State : Bridgewater, MA  
Weather : Clear

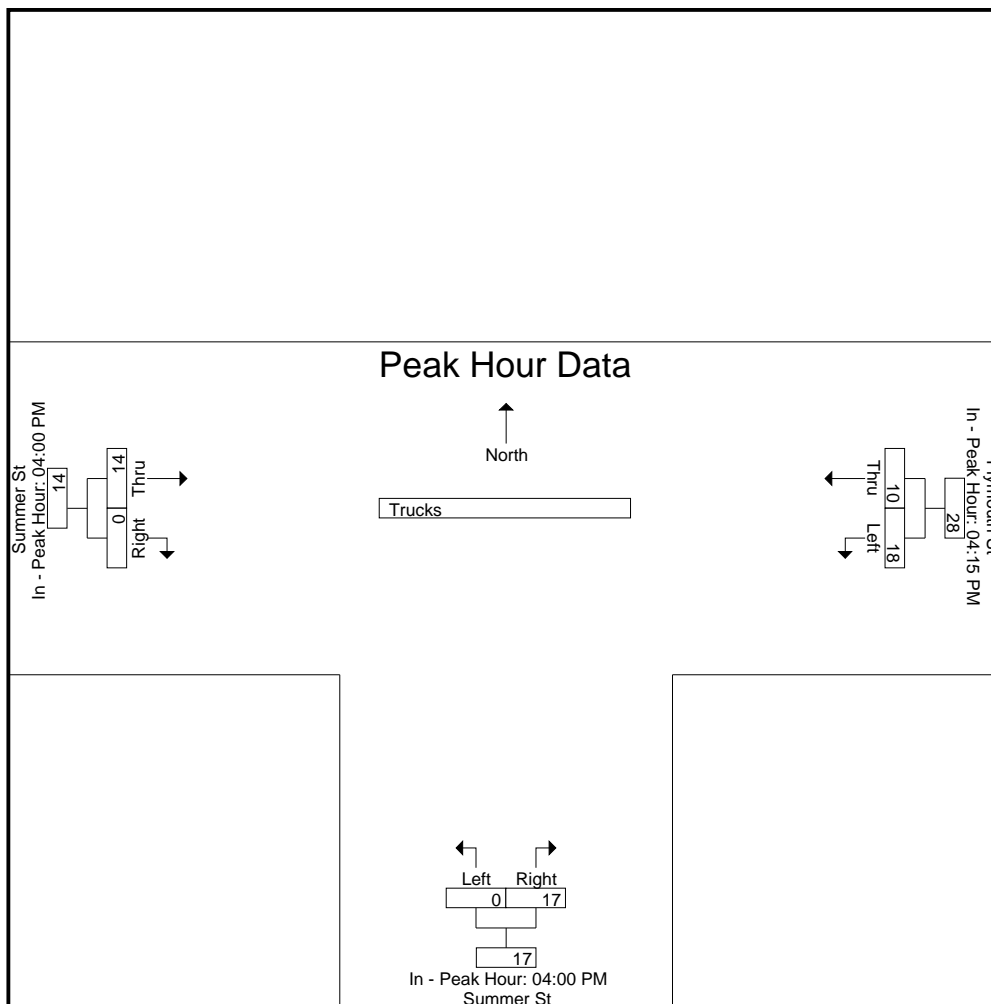





# Accurate Counts

978-664-2565

File Name : 20270B14

Site Code : 20270014

Start Date : 10/2/2024

Page No : 12

N/S Street : Summer Street  
E/W Street : Plymouth St / Summer St  
City/State : Bridgewater, MA  
Weather : Clear

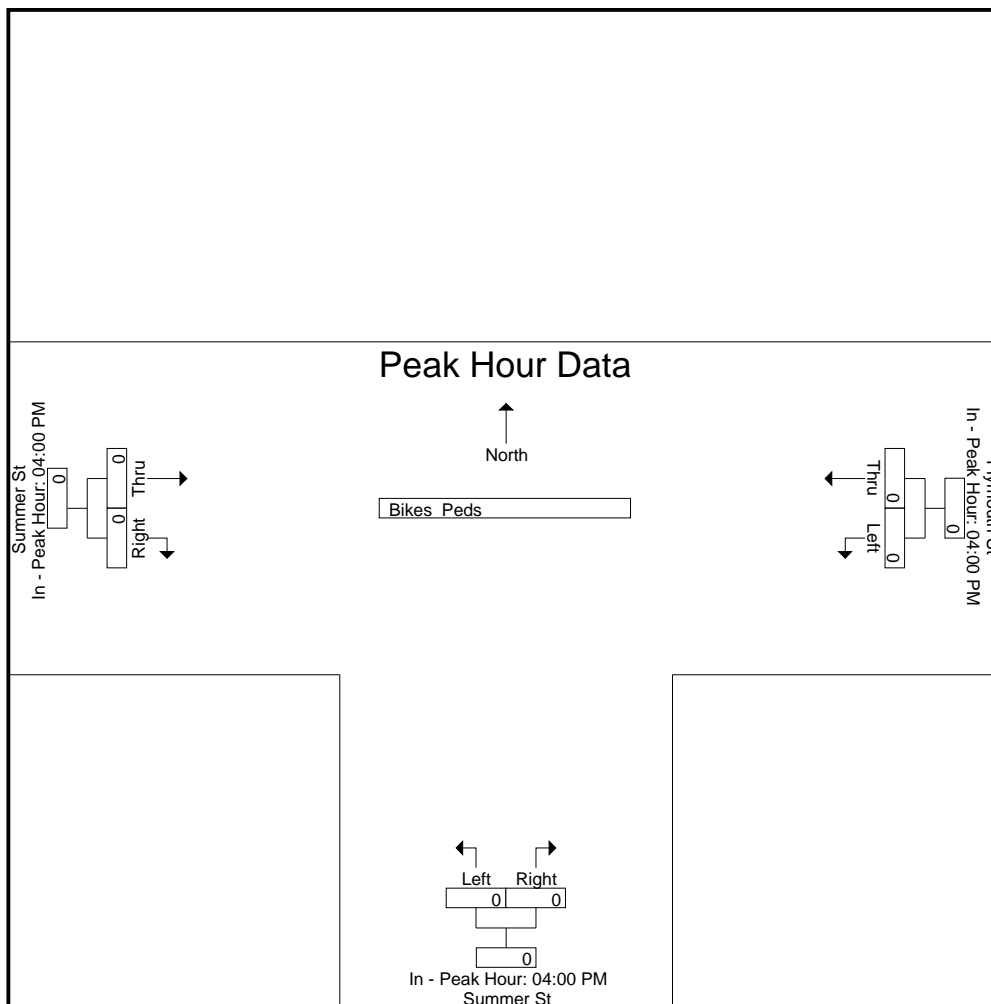



# Accurate Counts

978-664-2565

N/S Street : Hale Street / Welcome Center  
 E/W Street : Plymouth Street  
 City/State : Bridgewater, MA  
 Weather : Clear

File Name : 20270B15  
 Site Code : 20270015  
 Start Date : 10/2/2024  
 Page No : 1

### Groups Printed- Cars - Trucks

Start Time	Hale St From North			Plymouth St From East			Welcome Center From South			Plymouth St From West			Int. Total
	Left	Thru	Right	Left	Thru	Right	Left	Thru	Right	Left	Thru	Right	
07:00 AM	0	0	0	0	116	0	0	0	2	1	64	0	183
07:15 AM	2	0	1	0	95	0	0	0	0	2	88	6	194
07:30 AM	1	0	2	0	119	1	0	0	5	7	98	7	240
07:45 AM	3	0	5	0	133	1	0	0	1	4	108	9	264
<b>Total</b>	<b>6</b>	<b>0</b>	<b>8</b>	<b>0</b>	<b>463</b>	<b>2</b>	<b>0</b>	<b>0</b>	<b>8</b>	<b>14</b>	<b>358</b>	<b>22</b>	<b>881</b>
08:00 AM	1	1	4	1	110	1	0	2	1	4	97	10	232
08:15 AM	2	0	0	0	115	0	0	0	5	4	101	14	241
08:30 AM	0	2	2	1	99	0	0	0	3	2	117	14	240
08:45 AM	2	0	5	0	112	0	0	0	5	2	119	15	260
<b>Total</b>	<b>5</b>	<b>3</b>	<b>11</b>	<b>2</b>	<b>436</b>	<b>1</b>	<b>0</b>	<b>2</b>	<b>14</b>	<b>12</b>	<b>434</b>	<b>53</b>	<b>973</b>
<b>Grand Total</b>	<b>11</b>	<b>3</b>	<b>19</b>	<b>2</b>	<b>899</b>	<b>3</b>	<b>0</b>	<b>2</b>	<b>22</b>	<b>26</b>	<b>792</b>	<b>75</b>	<b>1854</b>
Apprch %	33.3	9.1	57.6	0.2	99.4	0.3	0	8.3	91.7	2.9	88.7	8.4	
Total %	0.6	0.2	1	0.1	48.5	0.2	0	0.1	1.2	1.4	42.7	4	
Cars	11	3	18	2	853	3	0	2	22	26	742	75	1757
% Cars	100	100	94.7	100	94.9	100	0	100	100	100	93.7	100	94.8
Trucks	0	0	1	0	46	0	0	0	0	0	50	0	97
% Trucks	0	0	5.3	0	5.1	0	0	0	0	0	6.3	0	5.2

Start Time	Hale St From North				Plymouth St From East				Welcome Center From South				Plymouth St From West				Int. Total
	Left	Thru	Right	App. Total	Left	Thru	Right	App. Total	Left	Thru	Right	App. Total	Left	Thru	Right	App. Total	
Peak Hour Analysis From 07:00 AM to 08:45 AM - Peak 1 of 1																	
Peak Hour for Entire Intersection Begins at 07:30 AM																	
07:30 AM	1	0	2	3	0	119	1	120	0	0	5	5	7	98	7	112	240
07:45 AM	3	0	5	8	0	133	1	134	0	0	1	1	4	108	9	121	264
08:00 AM	1	1	4	6	1	110	1	112	0	2	1	3	4	97	10	111	232
08:15 AM	2	0	0	2	0	115	0	115	0	0	5	5	4	101	14	119	241
<b>Total Volume</b>	<b>7</b>	<b>1</b>	<b>11</b>	<b>19</b>	<b>1</b>	<b>477</b>	<b>3</b>	<b>481</b>	<b>0</b>	<b>2</b>	<b>12</b>	<b>14</b>	<b>19</b>	<b>404</b>	<b>40</b>	<b>463</b>	<b>977</b>
% App. Total	36.8	5.3	57.9		0.2	99.2	0.6		0	14.3	85.7		4.1	87.3	8.6		
PHF	.583	.250	.550	.594	.250	.897	.750	.897	.000	.250	.600	.700	.679	.935	.714	.957	.925
Cars	7	1	10	18	1	454	3	458	0	2	12	14	19	378	40	437	927
% Cars	100	100	90.9	94.7	100	95.2	100	95.2	0	100	100	100	100	93.6	100	94.4	94.9
Trucks	0	0	1	1	0	23	0	23	0	0	0	0	0	26	0	26	50
% Trucks	0	0	9.1	5.3	0	4.8	0	4.8	0	0	0	0	0	6.4	0	5.6	5.1

# Accurate Counts

978-664-2565

N/S Street : Hale Street / Welcome Center

E/W Street : Plymouth Street

City/State : Bridgewater, MA

Weather : Clear

File Name : 20270B15

Site Code : 20270015

Start Date : 10/2/2024

Page No : 2

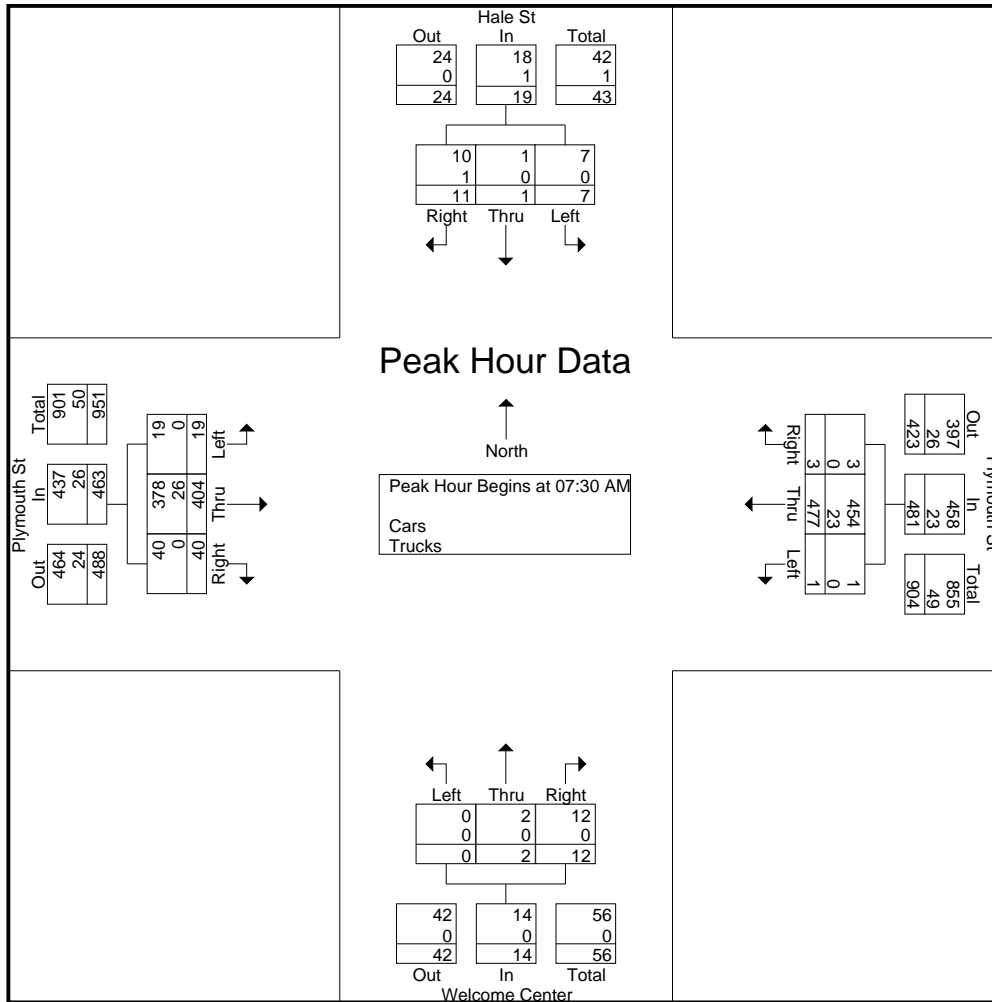

**Peak Hour Analysis From 07:00 AM to 08:45 AM - Peak 1 of 1**

**Peak Hour for Each Approach Begins at:**

	07:15 AM				07:30 AM				08:00 AM				08:00 AM			
+0 mins.	2	0	1	3	0	119	1	120	0	2	1	3	4	97	10	111
+15 mins.	1	0	2	3	0	133	1	134	0	0	5	5	4	101	14	119
+30 mins.	3	0	5	8	1	110	1	112	0	0	3	3	2	117	14	133
+45 mins.	1	1	4	6	0	115	0	115	0	0	5	5	2	119	15	136
Total Volume	7	1	12	20	1	477	3	481	0	2	14	16	12	434	53	499
% App. Total	35	5	60		0.2	99.2	0.6		0	12.5	87.5		2.4	87	10.6	
PHF	.583	.250	.600	.625	.250	.897	.750	.897	.000	.250	.700	.800	.750	.912	.883	.917
Cars	7	1	11	19	1	454	3	458	0	2	14	16	12	405	53	470
% Cars	100	100	91.7	95	100	95.2	100	95.2	0	100	100	100	100	93.3	100	94.2
Trucks	0	0	1	1	0	23	0	23	0	0	0	0	0	29	0	29
% Trucks	0	0	8.3	5	0	4.8	0	4.8	0	0	0	0	0	6.7	0	5.8

# Accurate Counts

978-664-2565

File Name : 20270B15

Site Code : 20270015

Start Date : 10/2/2024

Page No : 3

N/S Street : Hale Street / Welcome Center

E/W Street : Plymouth Street

City/State : Bridgewater, MA

Weather : Clear

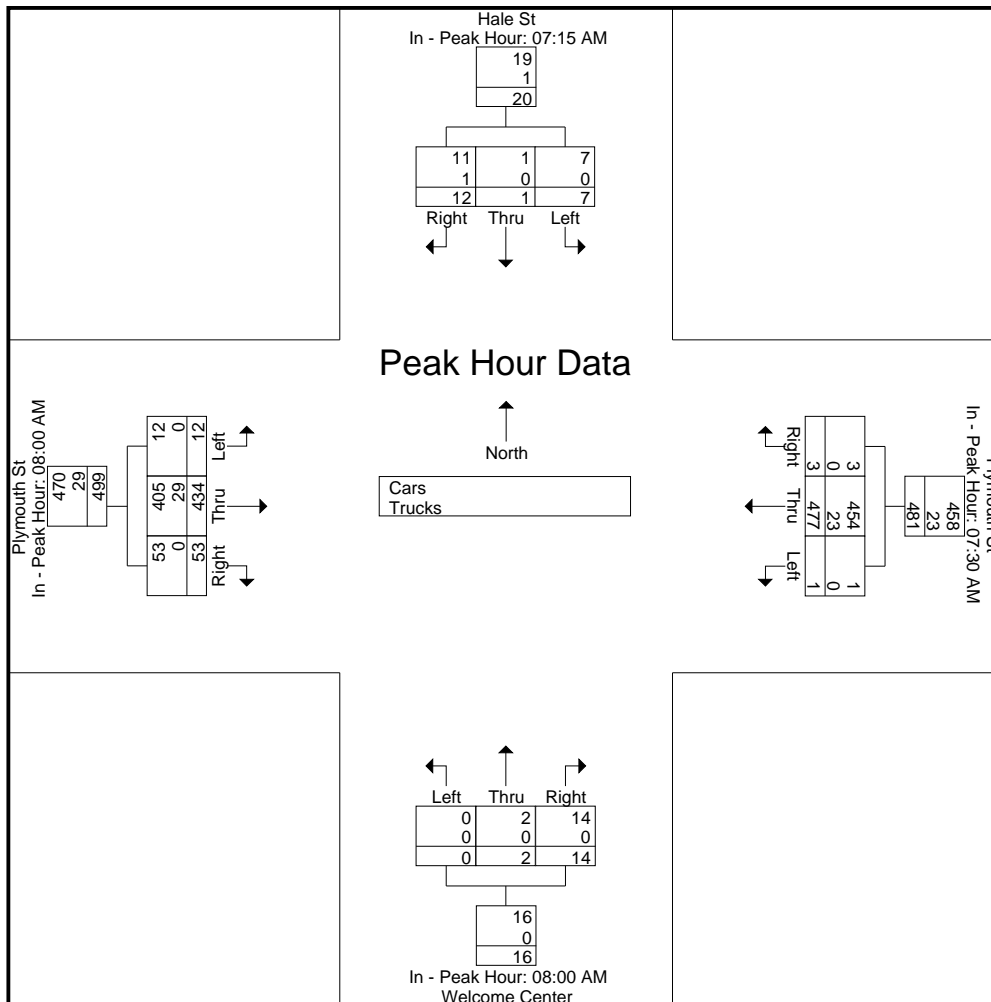

# Accurate Counts

978-664-2565

N/S Street : Hale Street / Welcome Center

E/W Street : Plymouth Street

City/State : Bridgewater, MA

Weather : Clear

File Name : 20270B15

Site Code : 20270015

Start Date : 10/2/2024

Page No : 4

## Groups Printed- Cars

Start Time	Hale St From North			Plymouth St From East			Welcome Center From South			Plymouth St From West			Int. Total
	Left	Thru	Right	Left	Thru	Right	Left	Thru	Right	Left	Thru	Right	
07:00 AM	0	0	0	0	109	0	0	0	2	1	60	0	172
07:15 AM	2	0	1	0	93	0	0	0	0	2	83	6	187
07:30 AM	1	0	2	0	115	1	0	0	5	7	92	7	230
07:45 AM	3	0	4	0	129	1	0	0	1	4	102	9	253
<b>Total</b>	<b>6</b>	<b>0</b>	<b>7</b>	<b>0</b>	<b>446</b>	<b>2</b>	<b>0</b>	<b>0</b>	<b>8</b>	<b>14</b>	<b>337</b>	<b>22</b>	<b>842</b>
08:00 AM	1	1	4	1	100	1	0	2	1	4	92	10	217
08:15 AM	2	0	0	0	110	0	0	0	5	4	92	14	227
08:30 AM	0	2	2	1	93	0	0	0	3	2	106	14	223
08:45 AM	2	0	5	0	104	0	0	0	5	2	115	15	248
<b>Total</b>	<b>5</b>	<b>3</b>	<b>11</b>	<b>2</b>	<b>407</b>	<b>1</b>	<b>0</b>	<b>2</b>	<b>14</b>	<b>12</b>	<b>405</b>	<b>53</b>	<b>915</b>
<b>Grand Total</b>	<b>11</b>	<b>3</b>	<b>18</b>	<b>2</b>	<b>853</b>	<b>3</b>	<b>0</b>	<b>2</b>	<b>22</b>	<b>26</b>	<b>742</b>	<b>75</b>	<b>1757</b>
Apprch %	34.4	9.4	56.2	0.2	99.4	0.3	0	8.3	91.7	3.1	88	8.9	
Total %	0.6	0.2	1	0.1	48.5	0.2	0	0.1	1.3	1.5	42.2	4.3	

Start Time	Hale St From North				Plymouth St From East				Welcome Center From South				Plymouth St From West				Int. Total
	Left	Thru	Right	App. Total	Left	Thru	Right	App. Total	Left	Thru	Right	App. Total	Left	Thru	Right	App. Total	
<b>Peak Hour Analysis From 07:00 AM to 08:45 AM - Peak 1 of 1</b>																	
<b>Peak Hour for Entire Intersection Begins at 07:30 AM</b>																	
07:30 AM	1	0	2	3	0	115	1	116	0	0	5	5	7	92	7	106	230
07:45 AM	3	0	4	7	0	129	1	130	0	0	1	1	4	102	9	115	253
08:00 AM	1	1	4	6	1	100	1	102	0	2	1	3	4	92	10	106	217
08:15 AM	2	0	0	2	0	110	0	110	0	0	5	5	4	92	14	110	227
<b>Total Volume</b>	<b>7</b>	<b>1</b>	<b>10</b>	<b>18</b>	<b>1</b>	<b>454</b>	<b>3</b>	<b>458</b>	<b>0</b>	<b>2</b>	<b>12</b>	<b>14</b>	<b>19</b>	<b>378</b>	<b>40</b>	<b>437</b>	<b>927</b>
<b>% App. Total</b>	<b>38.9</b>	<b>5.6</b>	<b>55.6</b>		<b>0.2</b>	<b>99.1</b>	<b>0.7</b>		<b>0</b>	<b>14.3</b>	<b>85.7</b>		<b>4.3</b>	<b>86.5</b>	<b>9.2</b>		
PHF	.583	.250	.625	.643	.250	.880	.750	.881	.000	.250	.600	.700	.679	.926	.714	.950	.916

# Accurate Counts

978-664-2565

N/S Street : Hale Street / Welcome Center

E/W Street : Plymouth Street

City/State : Bridgewater, MA

Weather : Clear

File Name : 20270B15

Site Code : 20270015

Start Date : 10/2/2024

Page No : 5

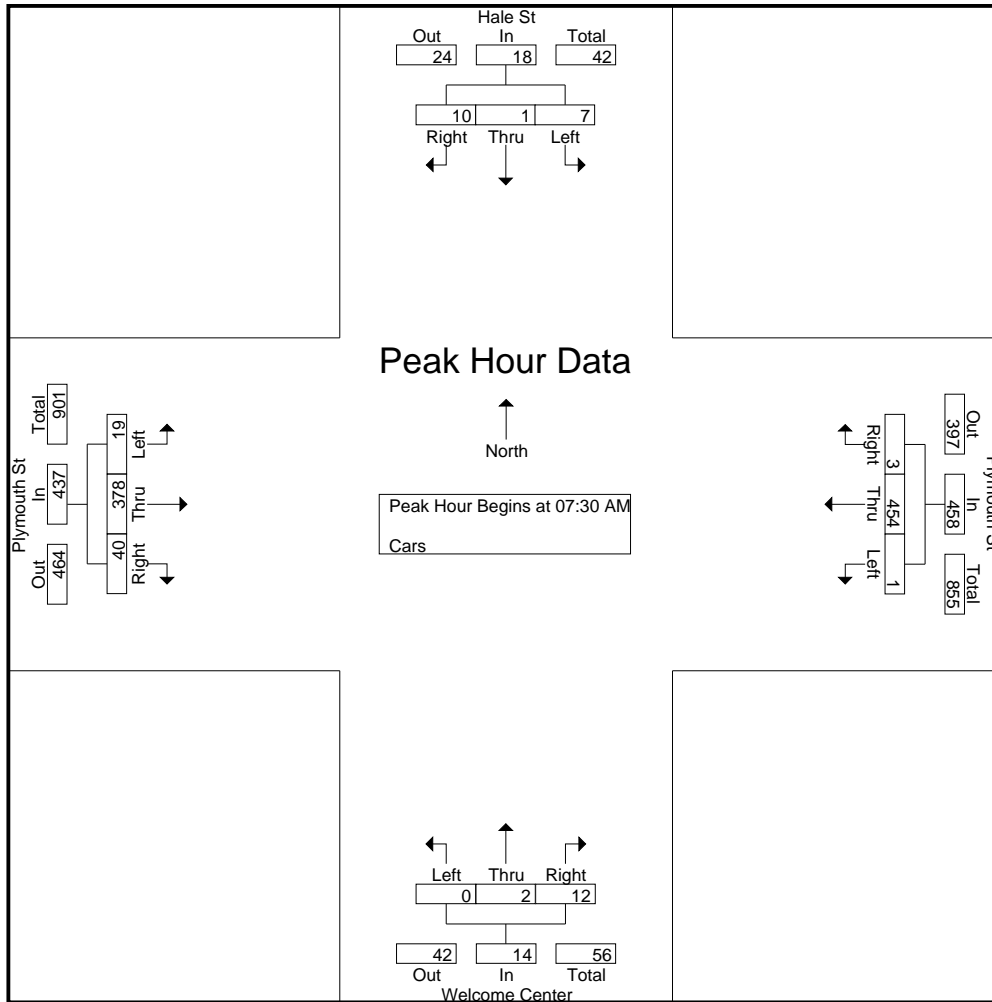

**Peak Hour Analysis From 07:00 AM to 08:45 AM - Peak 1 of 1**

**Peak Hour for Each Approach Begins at:**

	07:15 AM				07:30 AM				08:00 AM				08:00 AM			
+0 mins.	2	0	1	3	0	115	1	116	0	2	1	3	4	92	10	106
+15 mins.	1	0	2	3	0	129	1	130	0	0	5	5	4	92	14	110
+30 mins.	3	0	4	7	1	100	1	102	0	0	3	3	2	106	14	122
+45 mins.	1	1	4	6	0	110	0	110	0	0	5	5	2	115	15	132
<b>Total Volume</b>	7	1	11	19	1	454	3	458	0	2	14	16	12	405	53	470
<b>% App. Total</b>	36.8	5.3	57.9		0.2	99.1	0.7		0	12.5	87.5		2.6	86.2	11.3	
<b>PHF</b>	.583	.250	.688	.679	.250	.880	.750	.881	.000	.250	.700	.800	.750	.880	.883	.890

# Accurate Counts

978-664-2565

File Name : 20270B15

Site Code : 20270015

Start Date : 10/2/2024

Page No : 6

N/S Street : Hale Street / Welcome Center

E/W Street : Plymouth Street

City/State : Bridgewater, MA

Weather : Clear

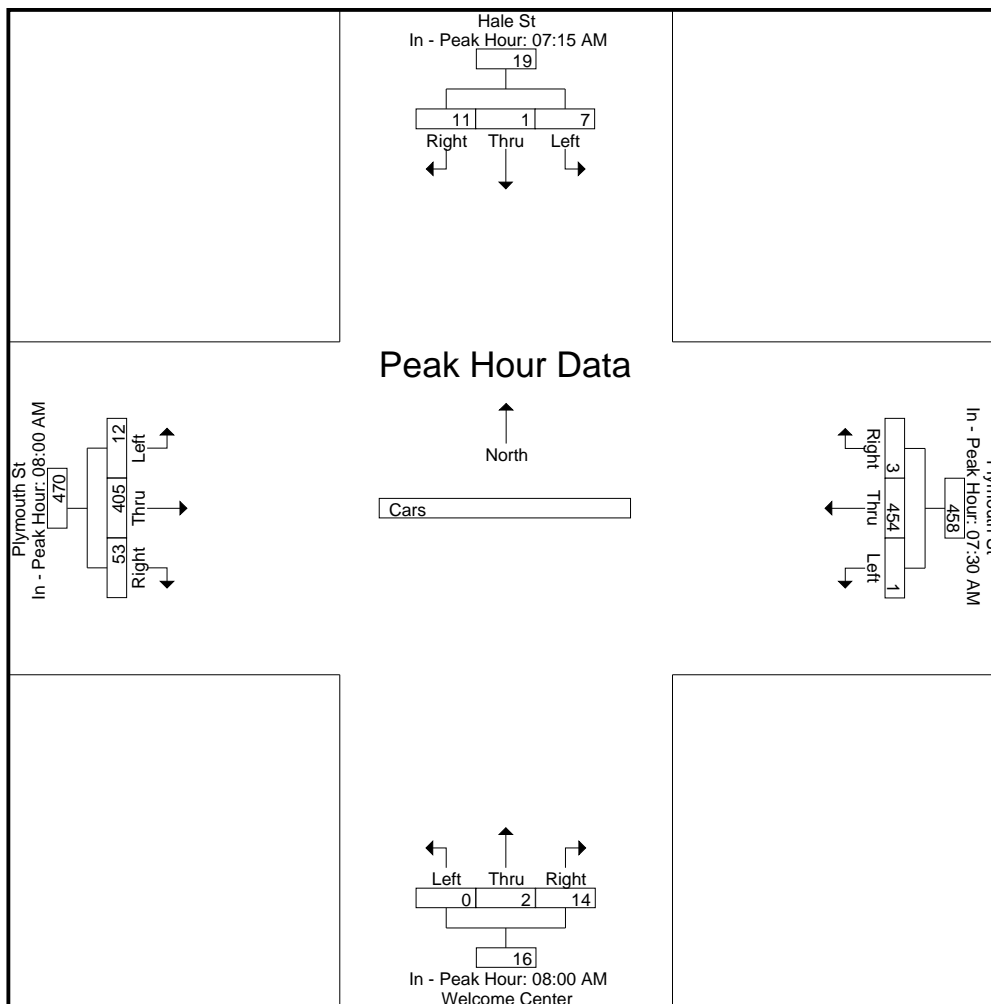

# Accurate Counts

978-664-2565

N/S Street : Hale Street / Welcome Center  
 E/W Street : Plymouth Street  
 City/State : Bridgewater, MA  
 Weather : Clear

File Name : 20270B15  
 Site Code : 20270015  
 Start Date : 10/2/2024  
 Page No : 7

### Groups Printed- Trucks

Start Time	Hale St From North			Plymouth St From East			Welcome Center From South			Plymouth St From West			Int. Total
	Left	Thru	Right	Left	Thru	Right	Left	Thru	Right	Left	Thru	Right	
07:00 AM	0	0	0	0	7	0	0	0	0	0	4	0	11
07:15 AM	0	0	0	0	2	0	0	0	0	0	5	0	7
07:30 AM	0	0	0	0	4	0	0	0	0	0	6	0	10
07:45 AM	0	0	1	0	4	0	0	0	0	0	6	0	11
<b>Total</b>	0	0	1	0	17	0	0	0	0	0	21	0	39
08:00 AM	0	0	0	0	10	0	0	0	0	0	5	0	15
08:15 AM	0	0	0	0	5	0	0	0	0	0	9	0	14
08:30 AM	0	0	0	0	6	0	0	0	0	0	11	0	17
08:45 AM	0	0	0	0	8	0	0	0	0	0	4	0	12
<b>Total</b>	0	0	0	0	29	0	0	0	0	0	29	0	58
<b>Grand Total</b>	0	0	1	0	46	0	0	0	0	0	50	0	97
Apprch %	0	0	100	0	100	0	0	0	0	0	100	0	
Total %	0	0	1	0	47.4	0	0	0	0	0	51.5	0	

Start Time	Hale St From North				Plymouth St From East				Welcome Center From South				Plymouth St From West				Int. Total
	Left	Thru	Right	App. Total	Left	Thru	Right	App. Total	Left	Thru	Right	App. Total	Left	Thru	Right	App. Total	
<b>Peak Hour Analysis From 07:00 AM to 08:45 AM - Peak 1 of 1</b>																	
<b>Peak Hour for Entire Intersection Begins at 08:00 AM</b>																	
08:00 AM	0	0	0	0	0	10	0	10	0	0	0	0	0	5	0	5	15
08:15 AM	0	0	0	0	0	5	0	5	0	0	0	0	0	9	0	9	14
08:30 AM	0	0	0	0	0	6	0	6	0	0	0	0	0	11	0	11	17
08:45 AM	0	0	0	0	0	8	0	8	0	0	0	0	0	4	0	4	12
<b>Total Volume</b>	0	0	0	0	0	29	0	29	0	0	0	0	0	29	0	29	58
<b>% App. Total</b>	0	0	0	0	0	100	0	100	0	0	0	0	0	100	0	100	
PHF	.000	.000	.000	.000	.000	.725	.000	.725	.000	.000	.000	.000	.000	.659	.000	.659	.853

# Accurate Counts

978-664-2565

File Name : 20270B15

Site Code : 20270015

Start Date : 10/2/2024

Page No : 8

N/S Street : Hale Street / Welcome Center

E/W Street : Plymouth Street

City/State : Bridgewater, MA

Weather : Clear

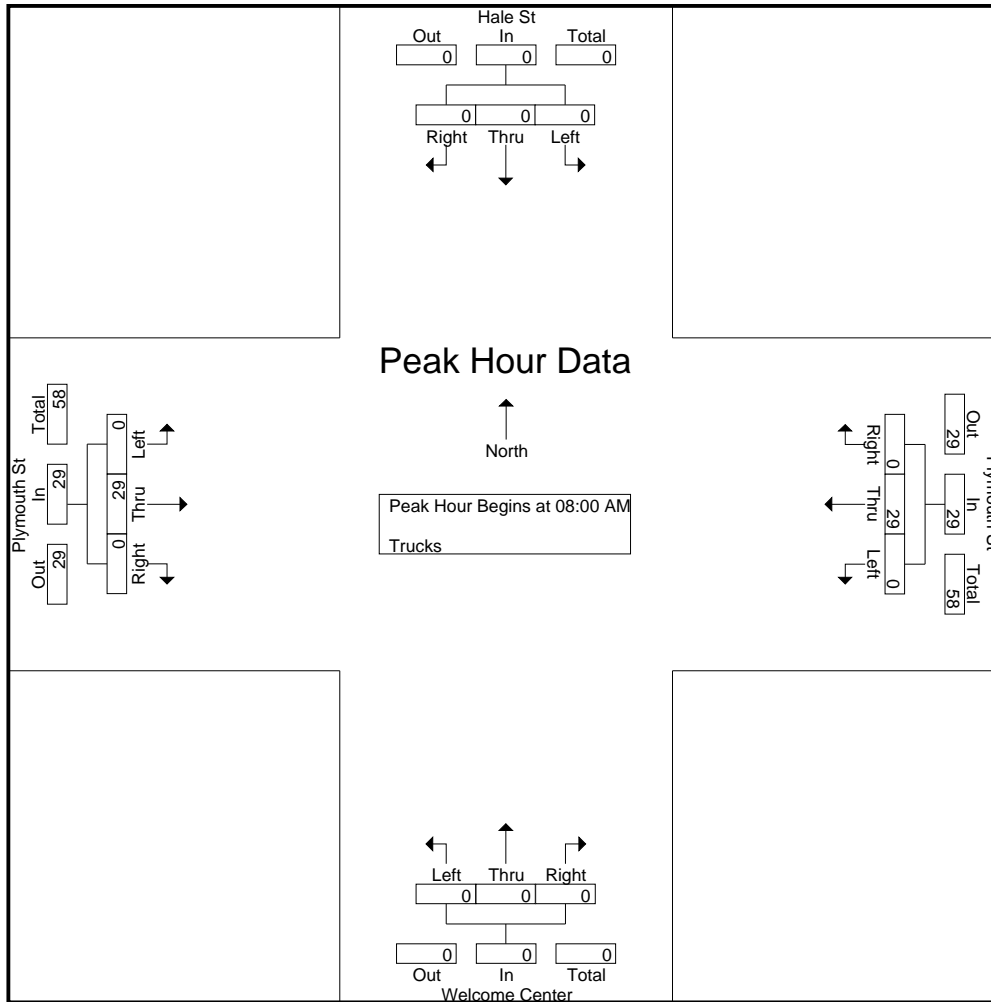

**Peak Hour Analysis From 07:00 AM to 08:45 AM - Peak 1 of 1**

**Peak Hour for Each Approach Begins at:**

	07:00 AM				08:00 AM				07:00 AM				07:45 AM			
+0 mins.	0	0	0	0	0	<b>10</b>	0	<b>10</b>	0	0	0	0	0	6	0	6
+15 mins.	0	0	0	0	0	5	0	5	0	0	0	0	0	5	0	5
+30 mins.	0	0	0	0	0	6	0	6	0	0	0	0	0	9	0	9
+45 mins.	0	0	<b>1</b>	<b>1</b>	0	8	0	8	0	0	0	0	0	<b>11</b>	0	<b>11</b>
Total Volume	0	0	1	1	0	29	0	29	0	0	0	0	0	31	0	31
% App. Total	0	0	100	100	0	100	0	100	0	0	0	0	0	100	0	100
PHF	.000	.000	.250	.250	.000	.725	.000	.725	.000	.000	.000	.000	.000	.705	.000	.705



# Accurate Counts

978-664-2565

File Name : 20270B15

Site Code : 20270015

Start Date : 10/2/2024

Page No : 9

N/S Street : Hale Street / Welcome Center

E/W Street : Plymouth Street

City/State : Bridgewater, MA

Weather : Clear

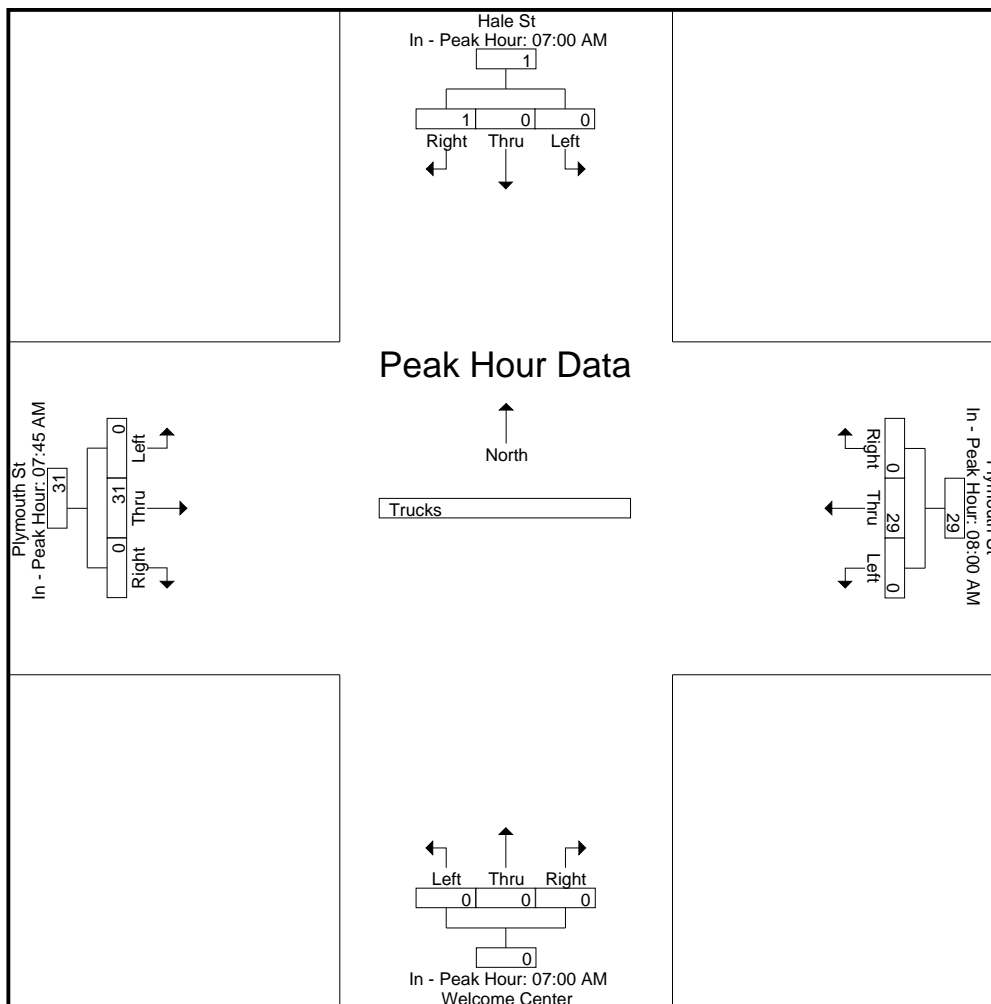

# Accurate Counts

978-664-2565

N/S Street : Hale Street / Welcome Center  
 E/W Street : Plymouth Street  
 City/State : Bridgewater, MA  
 Weather : Clear

File Name : 20270B15  
 Site Code : 20270015  
 Start Date : 10/2/2024  
 Page No : 10

### Groups Printed- Bikes Peds

Start Time	Hale St From North				Plymouth St From East				Welcome Center From South				Plymouth St From West				Exclu. Total	Inclu. Total	Int. Total	
	Left	Thru	Right	Peds	Left	Thru	Right	Peds	Left	Thru	Right	Peds	Left	Thru	Right	Peds				
07:00 AM	1	0	0	0	0	0	0	0	0	0	0	0	0	0	0	0	0	0	1	1
07:15 AM	0	0	0	0	0	0	0	0	0	0	0	5	0	0	0	0	5	0	0	5
07:30 AM	0	0	0	1	0	0	0	0	0	0	0	31	0	0	0	0	32	0	0	32
07:45 AM	0	0	0	2	0	0	0	2	0	0	0	34	0	0	0	2	40	0	0	40
<b>Total</b>	<b>1</b>	<b>0</b>	<b>0</b>	<b>3</b>	<b>0</b>	<b>0</b>	<b>0</b>	<b>2</b>	<b>0</b>	<b>0</b>	<b>0</b>	<b>70</b>	<b>0</b>	<b>0</b>	<b>0</b>	<b>2</b>	<b>77</b>	<b>1</b>	<b>0</b>	<b>78</b>
08:00 AM	0	0	0	0	0	0	0	0	0	0	0	8	0	0	0	0	8	0	0	8
08:15 AM	0	0	0	0	0	0	0	0	0	0	0	4	0	0	0	0	4	0	0	4
08:30 AM	0	0	0	2	0	0	0	0	0	0	0	13	0	1	0	0	15	1	0	16
08:45 AM	0	0	0	1	0	0	0	2	0	0	0	46	0	0	0	0	49	0	0	49
<b>Total</b>	<b>0</b>	<b>0</b>	<b>0</b>	<b>3</b>	<b>0</b>	<b>0</b>	<b>0</b>	<b>2</b>	<b>0</b>	<b>0</b>	<b>0</b>	<b>71</b>	<b>0</b>	<b>1</b>	<b>0</b>	<b>0</b>	<b>76</b>	<b>1</b>	<b>0</b>	<b>77</b>
<b>Grand Total</b>	<b>1</b>	<b>0</b>	<b>0</b>	<b>6</b>	<b>0</b>	<b>0</b>	<b>0</b>	<b>4</b>	<b>0</b>	<b>0</b>	<b>0</b>	<b>141</b>	<b>0</b>	<b>1</b>	<b>0</b>	<b>2</b>	<b>153</b>	<b>2</b>	<b>0</b>	<b>155</b>
Apprch %	100	0	0		0	0	0		0	0	0		0	100	0					
Total %	50	0	0		0	0	0		0	0	0		0	50	0		98.7	1.3		

Start Time	Hale St From North				Plymouth St From East				Welcome Center From South				Plymouth St From West				Int. Total	
	Left	Thru	Right	App. Total	Left	Thru	Right	App. Total	Left	Thru	Right	App. Total	Left	Thru	Right	App. Total		
Peak Hour Analysis From 07:00 AM to 08:45 AM - Peak 1 of 1																		
Peak Hour for Entire Intersection Begins at 07:00 AM																		
07:00 AM	1	0	0	1	0	0	0	0	0	0	0	0	0	0	0	0	0	1
07:15 AM	0	0	0	0	0	0	0	0	0	0	0	0	0	0	0	0	0	0
07:30 AM	0	0	0	0	0	0	0	0	0	0	0	0	0	0	0	0	0	0
07:45 AM	0	0	0	0	0	0	0	0	0	0	0	0	0	0	0	0	0	0
<b>Total Volume</b>	<b>1</b>	<b>0</b>	<b>0</b>	<b>1</b>	<b>0</b>	<b>0</b>	<b>0</b>	<b>0</b>	<b>0</b>	<b>0</b>	<b>0</b>	<b>0</b>	<b>0</b>	<b>0</b>	<b>0</b>	<b>0</b>	<b>0</b>	<b>1</b>
<b>% App. Total</b>	<b>100</b>	<b>0</b>	<b>0</b>		<b>0</b>	<b>0</b>	<b>0</b>		<b>0</b>	<b>0</b>	<b>0</b>		<b>0</b>	<b>0</b>	<b>0</b>			
PHF	.250	.000	.000	.250	.000	.000	.000	.000	.000	.000	.000	.000	.000	.000	.000	.000	.000	.250

# Accurate Counts

978-664-2565

N/S Street : Hale Street / Welcome Center

E/W Street : Plymouth Street

City/State : Bridgewater, MA

Weather : Clear

File Name : 20270B15

Site Code : 20270015

Start Date : 10/2/2024

Page No : 11

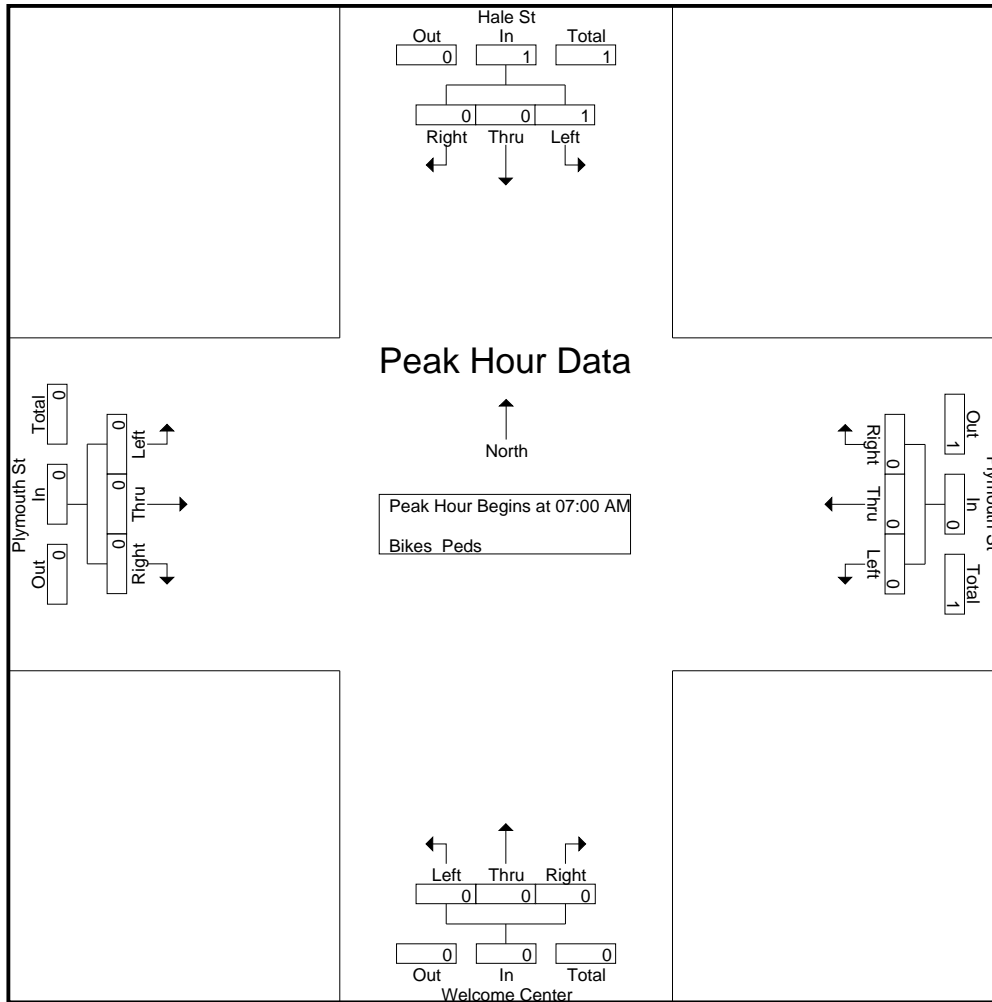

**Peak Hour Analysis From 07:00 AM to 08:45 AM - Peak 1 of 1**

**Peak Hour for Each Approach Begins at:**

	07:00 AM				07:00 AM				07:00 AM				07:45 AM			
+0 mins.	1	0	0	1	0	0	0	0	0	0	0	0	0	0	0	0
+15 mins.	0	0	0	0	0	0	0	0	0	0	0	0	0	0	0	0
+30 mins.	0	0	0	0	0	0	0	0	0	0	0	0	0	0	0	0
+45 mins.	0	0	0	0	0	0	0	0	0	0	0	0	0	1	0	1
Total Volume	1	0	0	1	0	0	0	0	0	0	0	0	0	1	0	1
% App. Total	100	0	0		0	0	0		0	0	0		0	100	0	
PHF	.250	.000	.000	.250	.000	.000	.000	.000	.000	.000	.000	.000	.000	.250	.000	.250

# Accurate Counts

978-664-2565

N/S Street : Hale Street / Welcome Center

E/W Street : Plymouth Street

City/State : Bridgewater, MA

Weather : Clear

File Name : 20270B15

Site Code : 20270015

Start Date : 10/2/2024

Page No : 12

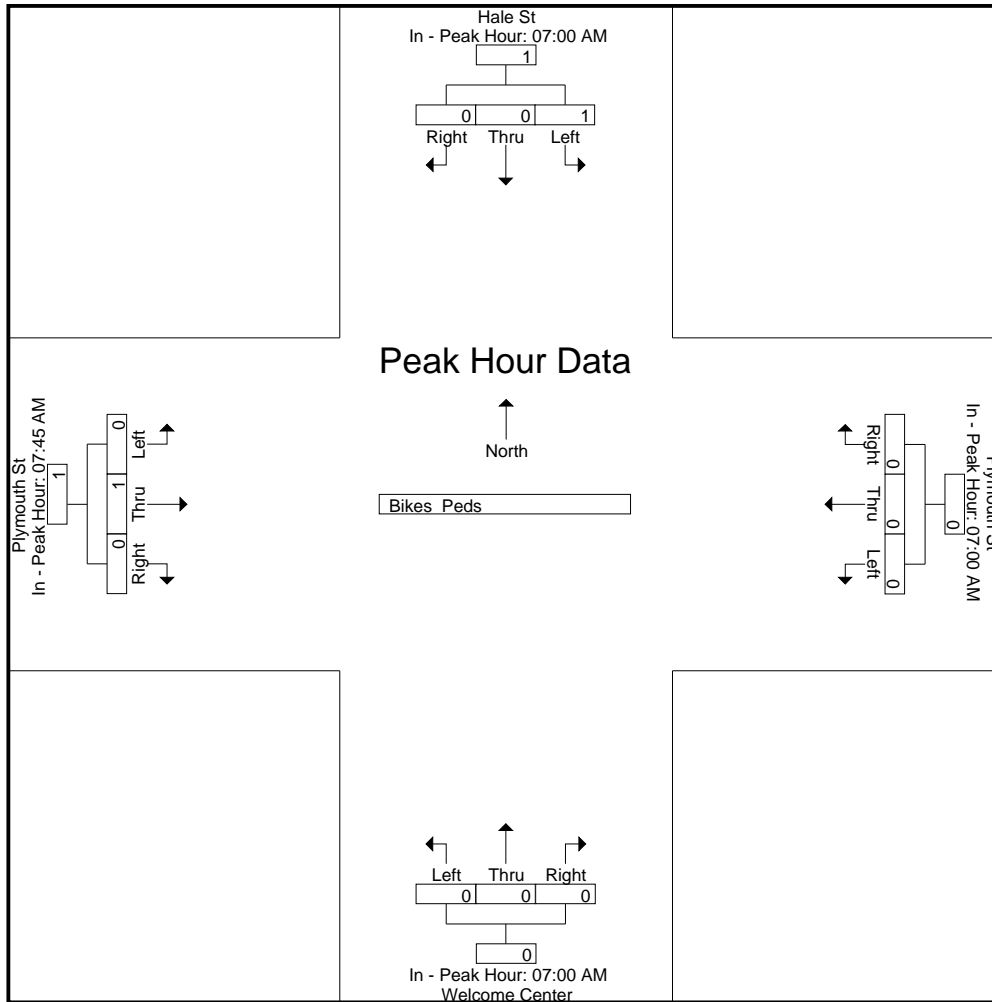

# Accurate Counts

978-664-2565

N/S Street : Hale Street / Welcome Center

E/W Street : Plymouth Street

City/State : Bridgewater, MA

Weather : Clear

File Name : 20270B15

Site Code : 20270015

Start Date : 10/2/2024

Page No : 1

### Groups Printed- Cars - Trucks

Start Time	Hale St From North			Plymouth St From East			Welcome Center From South			Plymouth St From West			Int. Total
	Left	Thru	Right	Left	Thru	Right	Left	Thru	Right	Left	Thru	Right	
04:00 PM	3	0	9	1	123	2	0	1	4	3	148	3	297
04:15 PM	6	0	5	0	129	0	0	0	9	4	126	5	284
04:30 PM	4	2	6	1	159	3	0	0	10	5	143	6	339
04:45 PM	1	0	10	0	133	2	0	1	4	3	167	5	326
<b>Total</b>	<b>14</b>	<b>2</b>	<b>30</b>	<b>2</b>	<b>544</b>	<b>7</b>	<b>0</b>	<b>2</b>	<b>27</b>	<b>15</b>	<b>584</b>	<b>19</b>	<b>1246</b>
05:00 PM	5	0	8	0	140	6	2	0	9	6	151	3	330
05:15 PM	2	0	6	3	152	4	0	0	8	2	137	3	317
05:30 PM	3	1	10	0	142	0	0	0	6	3	136	4	305
05:45 PM	5	0	7	1	160	4	0	1	3	7	130	6	324
<b>Total</b>	<b>15</b>	<b>1</b>	<b>31</b>	<b>4</b>	<b>594</b>	<b>14</b>	<b>2</b>	<b>1</b>	<b>26</b>	<b>18</b>	<b>554</b>	<b>16</b>	<b>1276</b>
<b>Grand Total</b>	<b>29</b>	<b>3</b>	<b>61</b>	<b>6</b>	<b>1138</b>	<b>21</b>	<b>2</b>	<b>3</b>	<b>53</b>	<b>33</b>	<b>1138</b>	<b>35</b>	<b>2522</b>
Apprch %	31.2	3.2	65.6	0.5	97.7	1.8	3.4	5.2	91.4	2.7	94.4	2.9	
Total %	1.1	0.1	2.4	0.2	45.1	0.8	0.1	0.1	2.1	1.3	45.1	1.4	
Cars	29	3	61	6	1114	21	2	3	53	33	1102	35	2462
% Cars	100	100	100	100	97.9	100	100	100	100	100	96.8	100	97.6
Trucks	0	0	0	0	24	0	0	0	0	0	36	0	60
% Trucks	0	0	0	0	2.1	0	0	0	0	0	3.2	0	2.4

Start Time	Hale St From North				Plymouth St From East				Welcome Center From South				Plymouth St From West				Int. Total
	Left	Thru	Right	App. Total	Left	Thru	Right	App. Total	Left	Thru	Right	App. Total	Left	Thru	Right	App. Total	
Peak Hour Analysis From 04:00 PM to 05:45 PM - Peak 1 of 1																	
Peak Hour for Entire Intersection Begins at 04:30 PM																	
04:30 PM	4	2	6	12	1	159	3	163	0	0	10	10	5	143	6	154	339
04:45 PM	1	0	10	11	0	133	2	135	0	1	4	5	3	167	5	175	326
05:00 PM	5	0	8	13	0	140	6	146	2	0	9	11	6	151	3	160	330
05:15 PM	2	0	6	8	3	152	4	159	0	0	8	8	2	137	3	142	317
<b>Total Volume</b>	<b>12</b>	<b>2</b>	<b>30</b>	<b>44</b>	<b>4</b>	<b>584</b>	<b>15</b>	<b>603</b>	<b>2</b>	<b>1</b>	<b>31</b>	<b>34</b>	<b>16</b>	<b>598</b>	<b>17</b>	<b>631</b>	<b>1312</b>
% App. Total	27.3	4.5	68.2		0.7	96.8	2.5		5.9	2.9	91.2		2.5	94.8	2.7		
PHF	.600	.250	.750	.846	.333	.918	.625	.925	.250	.250	.775	.773	.667	.895	.708	.901	.968
Cars	12	2	30	44	4	572	15	591	2	1	31	34	16	581	17	614	1283
% Cars	100	100	100	100	100	97.9	100	98.0	100	100	100	100	100	97.2	100	97.3	97.8
Trucks	0	0	0	0	0	12	0	12	0	0	0	0	0	17	0	17	29
% Trucks	0	0	0	0	0	2.1	0	2.0	0	0	0	0	0	2.8	0	2.7	2.2

# Accurate Counts

978-664-2565

N/S Street : Hale Street / Welcome Center

E/W Street : Plymouth Street

City/State : Bridgewater, MA

Weather : Clear

File Name : 20270B15

Site Code : 20270015

Start Date : 10/2/2024

Page No : 2

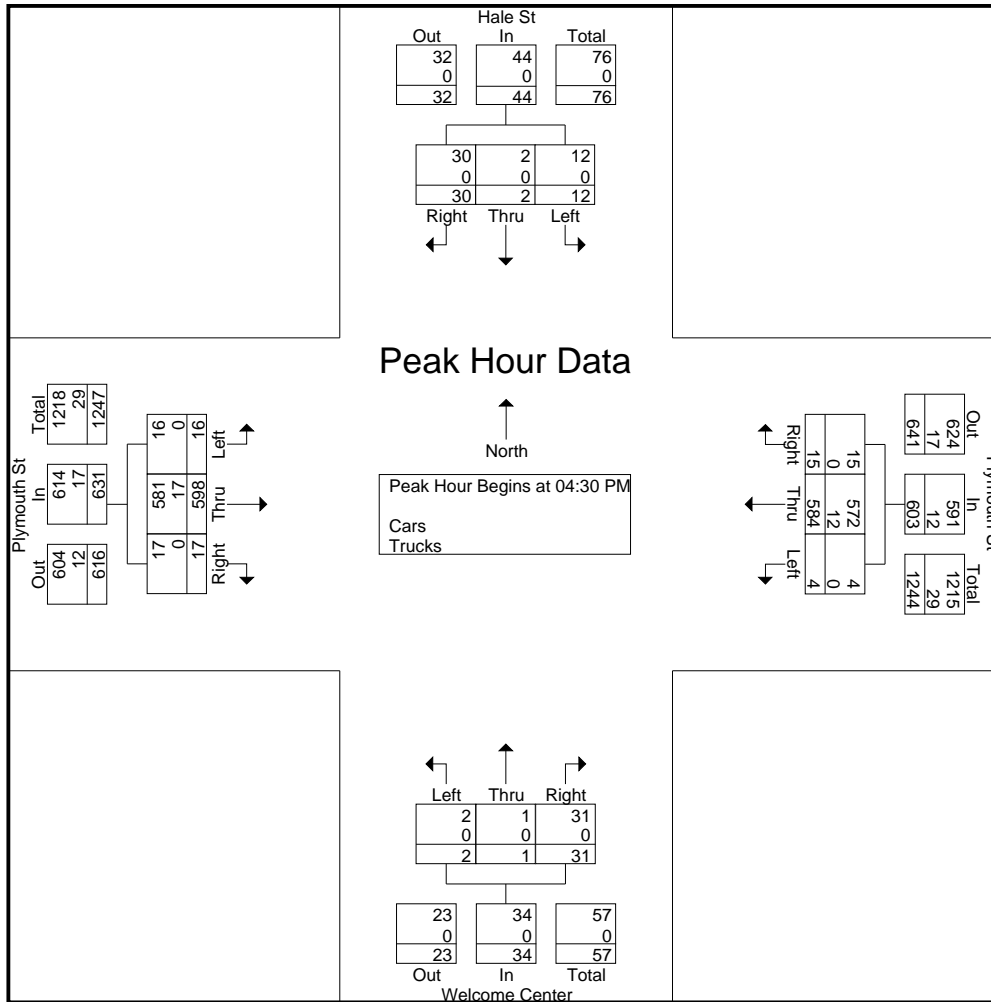

**Peak Hour Analysis From 04:00 PM to 05:45 PM - Peak 1 of 1**

**Peak Hour for Each Approach Begins at:**

	04:15 PM				05:00 PM				04:15 PM				04:30 PM			
+0 mins.	6	0	5	11	0	140	6	146	0	0	9	9	5	143	6	154
+15 mins.	4	2	6	12	3	152	4	159	0	0	10	10	3	167	5	175
+30 mins.	1	0	10	11	0	142	0	142	0	1	4	5	6	151	3	160
+45 mins.	5	0	8	13	1	160	4	165	2	0	9	11	2	137	3	142
Total Volume	16	2	29	47	4	594	14	612	2	1	32	35	16	598	17	631
% App. Total	34	4.3	61.7		0.7	97.1	2.3		5.7	2.9	91.4		2.5	94.8	2.7	
PHF	.667	.250	.725	.904	.333	.928	.583	.927	.250	.250	.800	.795	.667	.895	.708	.901
Cars	16	2	29	47	4	586	14	604	2	1	32	35	16	581	17	614
% Cars	100	100	100	100	100	98.7	100	98.7	100	100	100	100	100	97.2	100	97.3
Trucks	0	0	0	0	0	8	0	8	0	0	0	0	0	17	0	17
% Trucks	0	0	0	0	0	1.3	0	1.3	0	0	0	0	0	2.8	0	2.7

# Accurate Counts

978-664-2565

File Name : 20270B15

Site Code : 20270015

Start Date : 10/2/2024

Page No : 3

N/S Street : Hale Street / Welcome Center

E/W Street : Plymouth Street

City/State : Bridgewater, MA

Weather : Clear

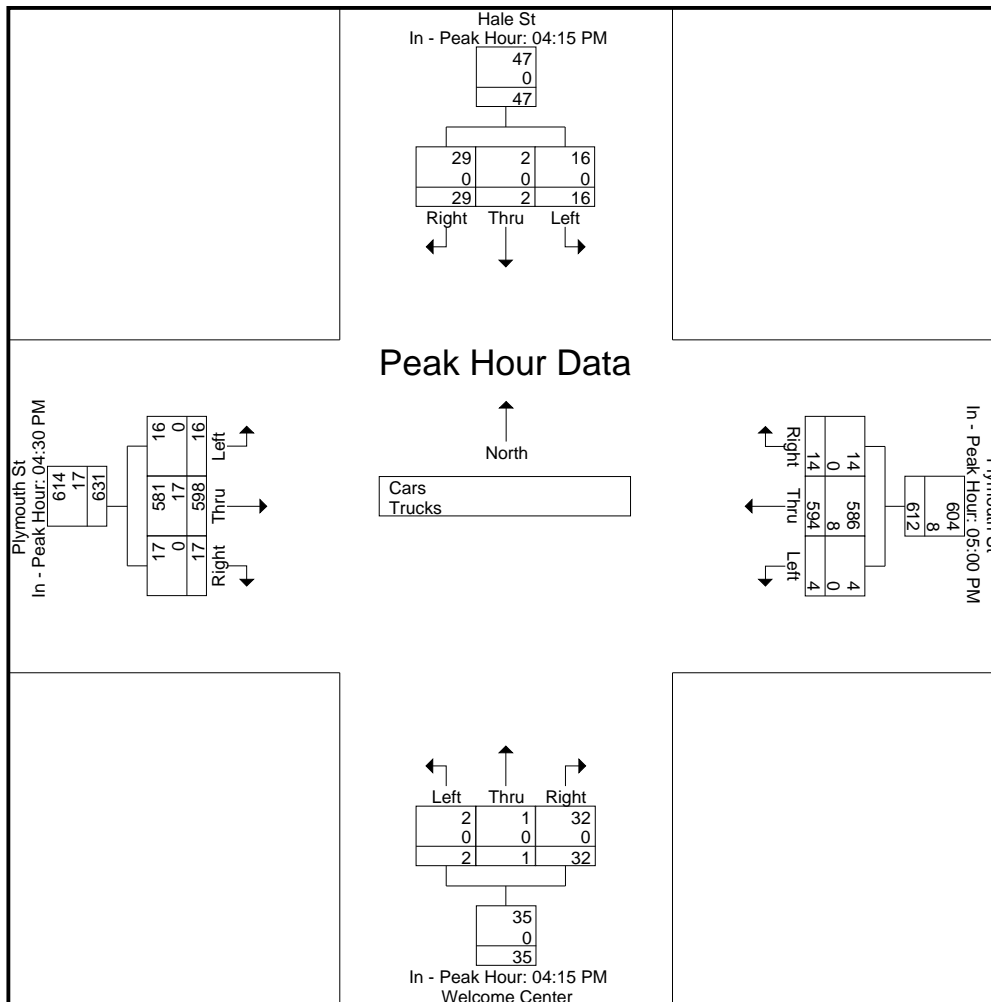

# Accurate Counts

978-664-2565

N/S Street : Hale Street / Welcome Center  
 E/W Street : Plymouth Street  
 City/State : Bridgewater, MA  
 Weather : Clear

File Name : 20270B15  
 Site Code : 20270015  
 Start Date : 10/2/2024  
 Page No : 4

## Groups Printed- Cars

Start Time	Hale St From North			Plymouth St From East			Welcome Center From South			Plymouth St From West			Int. Total
	Left	Thru	Right	Left	Thru	Right	Left	Thru	Right	Left	Thru	Right	
04:00 PM	3	0	9	1	119	2	0	1	4	3	140	3	285
04:15 PM	6	0	5	0	123	0	0	0	9	4	119	5	271
04:30 PM	4	2	6	1	155	3	0	0	10	5	139	6	331
04:45 PM	1	0	10	0	131	2	0	1	4	3	159	5	316
<b>Total</b>	<b>14</b>	<b>2</b>	<b>30</b>	<b>2</b>	<b>528</b>	<b>7</b>	<b>0</b>	<b>2</b>	<b>27</b>	<b>15</b>	<b>557</b>	<b>19</b>	<b>1203</b>
05:00 PM	5	0	8	0	136	6	2	0	9	6	149	3	324
05:15 PM	2	0	6	3	150	4	0	0	8	2	134	3	312
05:30 PM	3	1	10	0	141	0	0	0	6	3	133	4	301
05:45 PM	5	0	7	1	159	4	0	1	3	7	129	6	322
<b>Total</b>	<b>15</b>	<b>1</b>	<b>31</b>	<b>4</b>	<b>586</b>	<b>14</b>	<b>2</b>	<b>1</b>	<b>26</b>	<b>18</b>	<b>545</b>	<b>16</b>	<b>1259</b>
<b>Grand Total</b>	<b>29</b>	<b>3</b>	<b>61</b>	<b>6</b>	<b>1114</b>	<b>21</b>	<b>2</b>	<b>3</b>	<b>53</b>	<b>33</b>	<b>1102</b>	<b>35</b>	<b>2462</b>
Apprch %	31.2	3.2	65.6	0.5	97.6	1.8	3.4	5.2	91.4	2.8	94.2	3	
Total %	1.2	0.1	2.5	0.2	45.2	0.9	0.1	0.1	2.2	1.3	44.8	1.4	

Start Time	Hale St From North				Plymouth St From East				Welcome Center From South				Plymouth St From West				Int. Total
	Left	Thru	Right	App. Total	Left	Thru	Right	App. Total	Left	Thru	Right	App. Total	Left	Thru	Right	App. Total	
Peak Hour Analysis From 04:00 PM to 05:45 PM - Peak 1 of 1																	
Peak Hour for Entire Intersection Begins at 04:30 PM																	
04:30 PM	4	2	6	12	1	155	3	159	0	0	10	10	5	139	6	150	331
04:45 PM	1	0	10	11	0	131	2	133	0	1	4	5	3	159	5	167	316
05:00 PM	5	0	8	13	0	136	6	142	2	0	9	11	6	149	3	158	324
05:15 PM	2	0	6	8	3	150	4	157	0	0	8	8	2	134	3	139	312
<b>Total Volume</b>	<b>12</b>	<b>2</b>	<b>30</b>	<b>44</b>	<b>4</b>	<b>572</b>	<b>15</b>	<b>591</b>	<b>2</b>	<b>1</b>	<b>31</b>	<b>34</b>	<b>16</b>	<b>581</b>	<b>17</b>	<b>614</b>	<b>1283</b>
% App. Total	27.3	4.5	68.2		0.7	96.8	2.5		5.9	2.9	91.2		2.6	94.6	2.8		
PHF	.600	.250	.750	.846	.333	.923	.625	.929	.250	.250	.775	.773	.667	.914	.708	.919	.969



# Accurate Counts

978-664-2565

N/S Street : Hale Street / Welcome Center

E/W Street : Plymouth Street

City/State : Bridgewater, MA

Weather : Clear

File Name : 20270B15

Site Code : 20270015

Start Date : 10/2/2024

Page No : 5

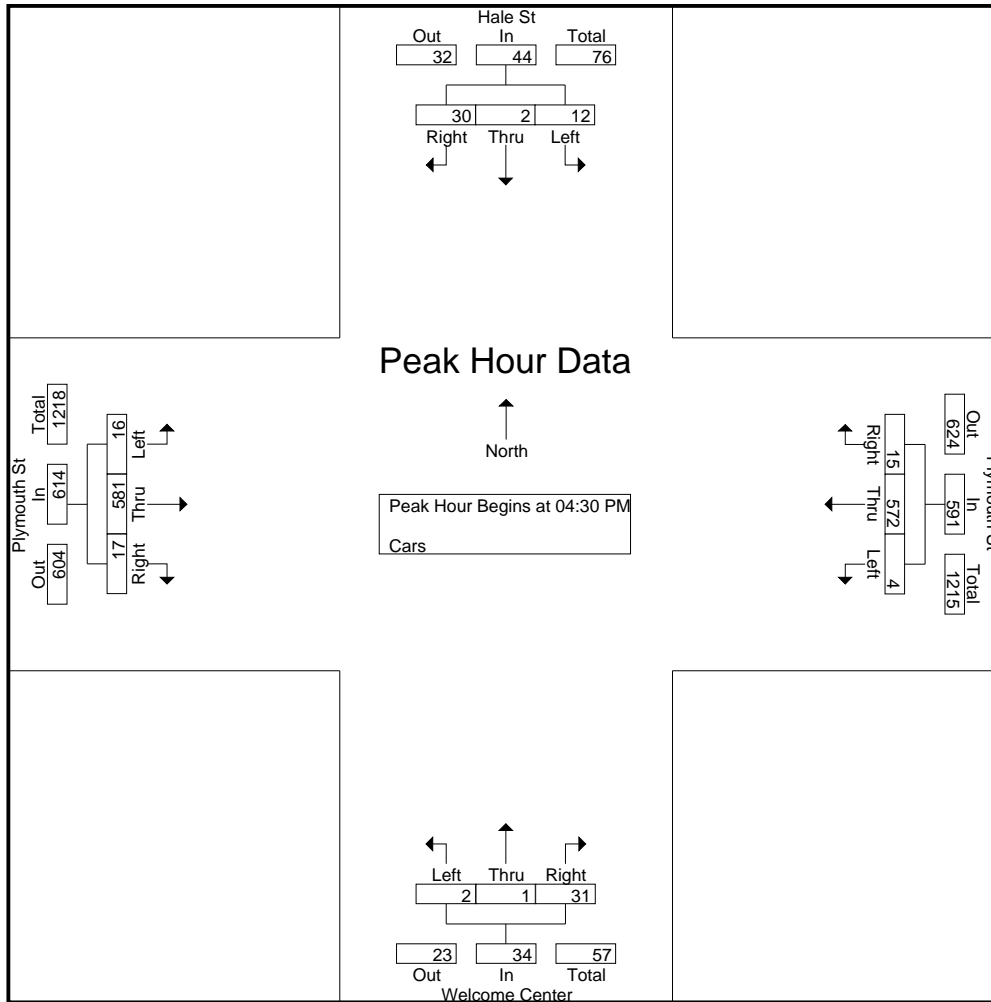

**Peak Hour Analysis From 04:00 PM to 05:45 PM - Peak 1 of 1**

**Peak Hour for Each Approach Begins at:**

	04:15 PM				05:00 PM				04:15 PM				04:30 PM			
+0 mins.	<b>6</b>	0	5	11	0	136	<b>6</b>	142	0	0	9	9	5	139	<b>6</b>	150
+15 mins.	4	<b>2</b>	6	12	<b>3</b>	150	4	157	0	0	<b>10</b>	10	3	<b>159</b>	5	<b>167</b>
+30 mins.	1	0	<b>10</b>	11	0	141	0	141	0	<b>1</b>	4	5	<b>6</b>	149	3	158
+45 mins.	5	0	8	<b>13</b>	1	<b>159</b>	4	<b>164</b>	<b>2</b>	0	9	<b>11</b>	2	134	3	139
Total Volume	16	2	29	47	4	586	14	604	2	1	32	35	16	581	17	614
% App. Total	34	4.3	61.7		0.7	97	2.3		5.7	2.9	91.4		2.6	94.6	2.8	
PHF	.667	.250	.725	.904	.333	.921	.583	.921	.250	.250	.800	.795	.667	.914	.708	.919

# Accurate Counts

978-664-2565

File Name : 20270B15

Site Code : 20270015

Start Date : 10/2/2024

Page No : 6

N/S Street : Hale Street / Welcome Center

E/W Street : Plymouth Street

City/State : Bridgewater, MA

Weather : Clear

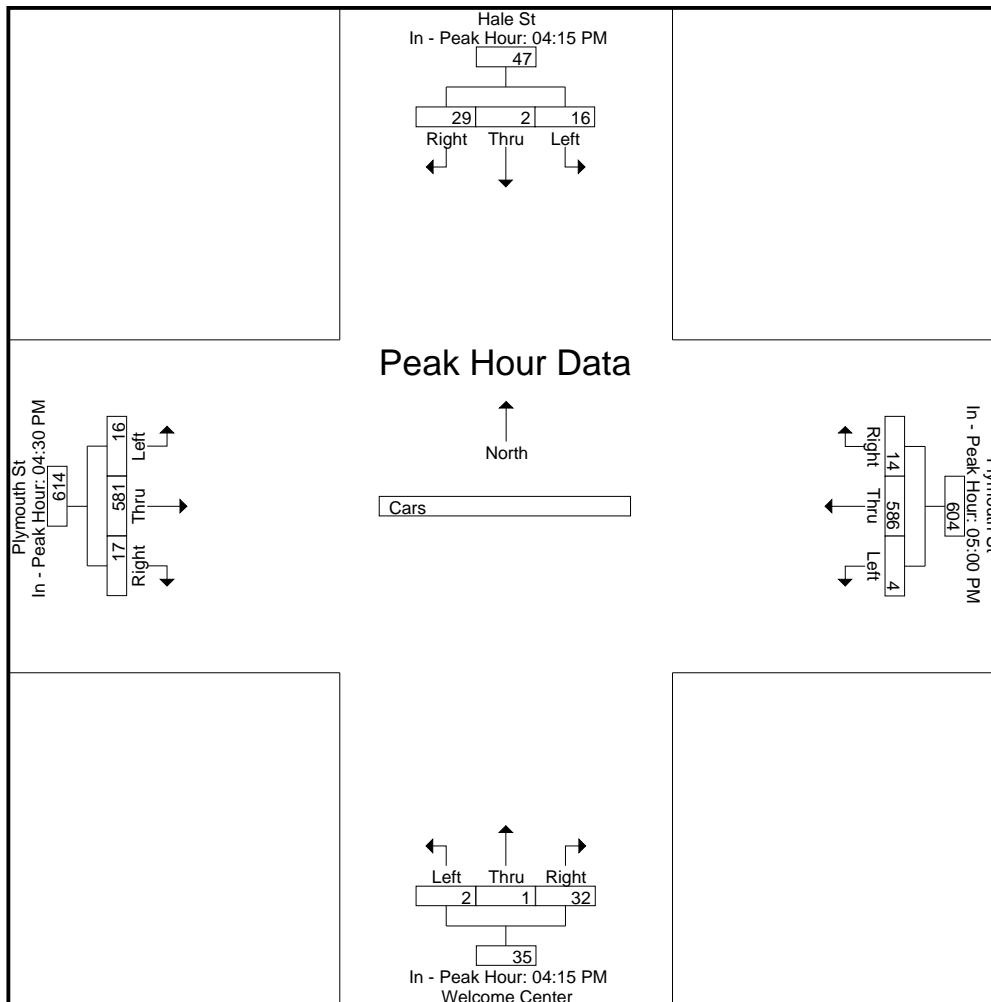

# Accurate Counts

978-664-2565

N/S Street : Hale Street / Welcome Center  
 E/W Street : Plymouth Street  
 City/State : Bridgewater, MA  
 Weather : Clear

File Name : 20270B15  
 Site Code : 20270015  
 Start Date : 10/2/2024  
 Page No : 7

### Groups Printed- Trucks

Start Time	Hale St From North			Plymouth St From East			Welcome Center From South			Plymouth St From West			Int. Total
	Left	Thru	Right	Left	Thru	Right	Left	Thru	Right	Left	Thru	Right	
04:00 PM	0	0	0	0	4	0	0	0	0	0	8	0	12
04:15 PM	0	0	0	0	6	0	0	0	0	0	7	0	13
04:30 PM	0	0	0	0	4	0	0	0	0	0	4	0	8
04:45 PM	0	0	0	0	2	0	0	0	0	0	8	0	10
<b>Total</b>	0	0	0	0	16	0	0	0	0	0	27	0	43
05:00 PM	0	0	0	0	4	0	0	0	0	0	2	0	6
05:15 PM	0	0	0	0	2	0	0	0	0	0	3	0	5
05:30 PM	0	0	0	0	1	0	0	0	0	0	3	0	4
05:45 PM	0	0	0	0	1	0	0	0	0	0	1	0	2
<b>Total</b>	0	0	0	0	8	0	0	0	0	0	9	0	17
<b>Grand Total</b>	0	0	0	0	24	0	0	0	0	0	36	0	60
Apprch %	0	0	0	0	100	0	0	0	0	0	100	0	
Total %	0	0	0	0	40	0	0	0	0	0	60	0	

Start Time	Hale St From North				Plymouth St From East				Welcome Center From South				Plymouth St From West				Int. Total
	Left	Thru	Right	App. Total	Left	Thru	Right	App. Total	Left	Thru	Right	App. Total	Left	Thru	Right	App. Total	
<b>Peak Hour Analysis From 04:00 PM to 05:45 PM - Peak 1 of 1</b>																	
<b>Peak Hour for Entire Intersection Begins at 04:00 PM</b>																	
04:00 PM	0	0	0	0	0	4	0	4	0	0	0	0	0	8	0	8	12
04:15 PM	0	0	0	0	0	6	0	6	0	0	0	0	0	7	0	7	13
04:30 PM	0	0	0	0	0	4	0	4	0	0	0	0	0	4	0	4	8
04:45 PM	0	0	0	0	0	2	0	2	0	0	0	0	0	8	0	8	10
<b>Total Volume</b>	0	0	0	0	0	16	0	16	0	0	0	0	0	27	0	27	43
<b>% App. Total</b>	0	0	0	0	0	100	0	100	0	0	0	0	0	100	0	100	
PHF	.000	.000	.000	.000	.000	.667	.000	.667	.000	.000	.000	.000	.000	.844	.000	.844	.827

# Accurate Counts

978-664-2565

N/S Street : Hale Street / Welcome Center

E/W Street : Plymouth Street

City/State : Bridgewater, MA

Weather : Clear

File Name : 20270B15

Site Code : 20270015

Start Date : 10/2/2024

Page No : 8

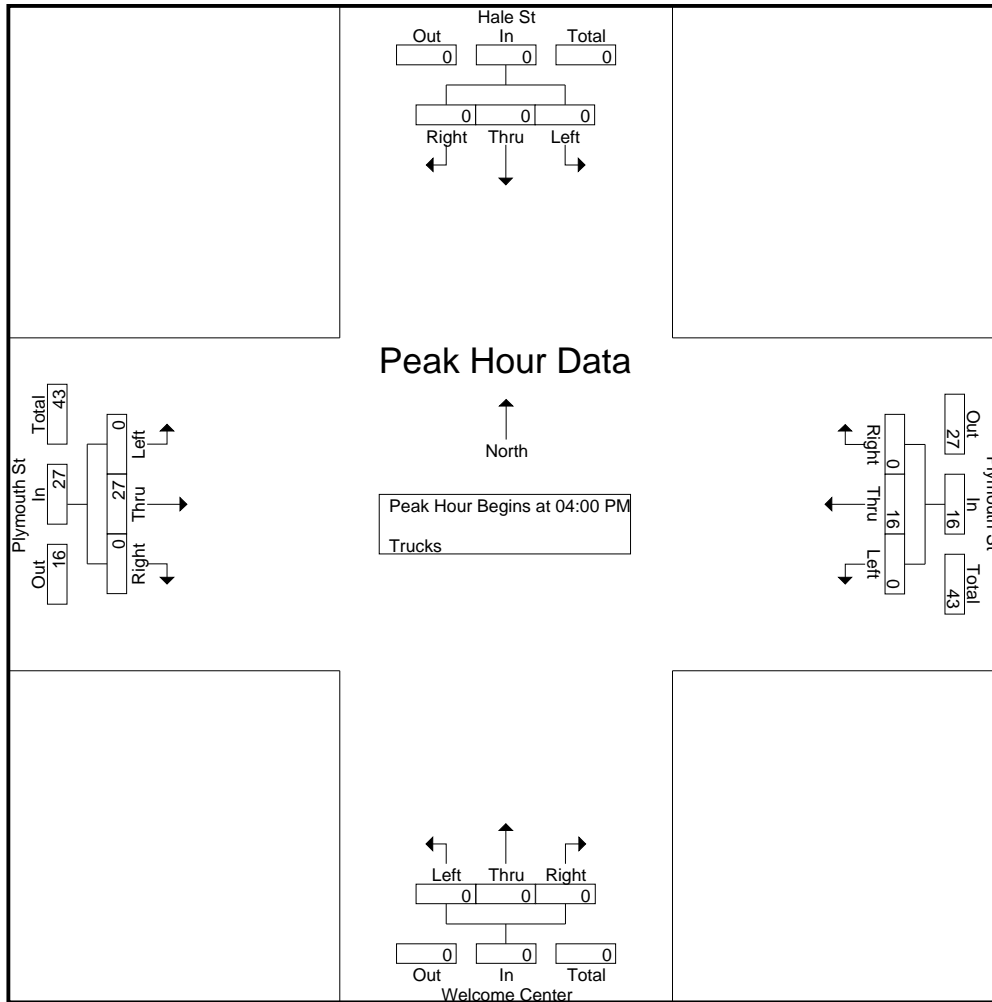

**Peak Hour Analysis From 04:00 PM to 05:45 PM - Peak 1 of 1**

**Peak Hour for Each Approach Begins at:**

	04:00 PM				04:00 PM				04:00 PM				04:00 PM			
+0 mins.	0	0	0	0	0	4	0	4	0	0	0	0	0	8	0	8
+15 mins.	0	0	0	0	0	6	0	6	0	0	0	0	0	7	0	7
+30 mins.	0	0	0	0	0	4	0	4	0	0	0	0	0	4	0	4
+45 mins.	0	0	0	0	0	2	0	2	0	0	0	0	0	8	0	8
Total Volume	0	0	0	0	0	16	0	16	0	0	0	0	0	27	0	27
% App. Total	0	0	0	0	0	100	0	100	0	0	0	0	0	100	0	100
PHF	.000	.000	.000	.000	.000	.667	.000	.667	.000	.000	.000	.000	.000	.844	.000	.844

# Accurate Counts

978-664-2565

File Name : 20270B15

Site Code : 20270015

Start Date : 10/2/2024

Page No : 9

N/S Street : Hale Street / Welcome Center

E/W Street : Plymouth Street

City/State : Bridgewater, MA

Weather : Clear

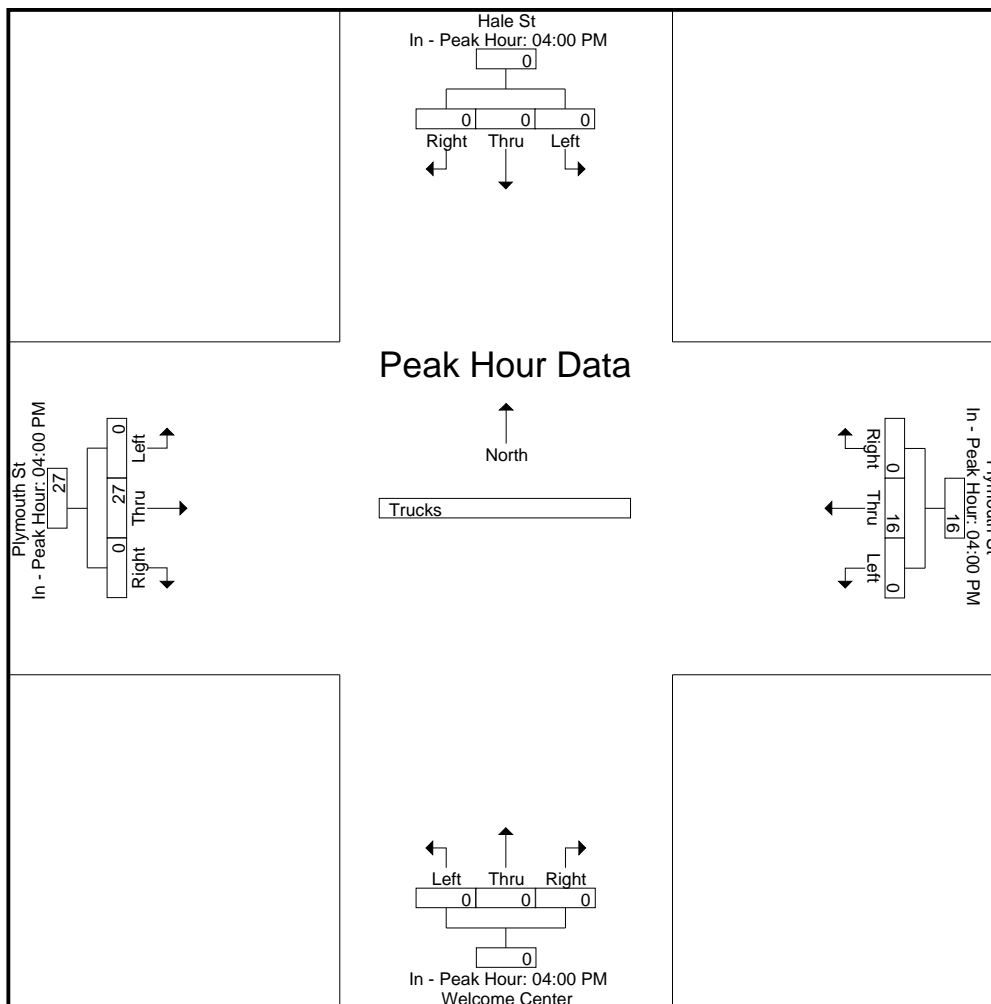

# Accurate Counts

978-664-2565

N/S Street : Hale Street / Welcome Center  
 E/W Street : Plymouth Street  
 City/State : Bridgewater, MA  
 Weather : Clear

File Name : 20270B15  
 Site Code : 20270015  
 Start Date : 10/2/2024  
 Page No : 10

### Groups Printed- Bikes Peds

Start Time	Hale St From North				Plymouth St From East				Welcome Center From South				Plymouth St From West				Exclu. Total	Inclu. Total	Int. Total
	Left	Thru	Right	Peds	Left	Thru	Right	Peds	Left	Thru	Right	Peds	Left	Thru	Right	Peds			
04:00 PM	0	0	0	0	0	0	0	0	0	0	0	10	0	1	0	0	10	1	11
04:15 PM	0	0	0	1	0	0	0	0	0	0	0	8	0	0	0	1	10	0	10
04:30 PM	0	0	0	5	0	0	0	0	0	0	0	19	0	1	0	0	24	1	25
04:45 PM	0	0	0	2	0	0	0	1	0	0	0	6	0	1	0	0	9	1	10
<b>Total</b>	<b>0</b>	<b>0</b>	<b>0</b>	<b>8</b>	<b>0</b>	<b>0</b>	<b>0</b>	<b>1</b>	<b>0</b>	<b>0</b>	<b>0</b>	<b>43</b>	<b>0</b>	<b>3</b>	<b>0</b>	<b>1</b>	<b>53</b>	<b>3</b>	<b>56</b>
05:00 PM	0	0	0	0	0	1	0	0	0	0	1	6	0	0	0	0	6	2	8
05:15 PM	0	0	0	0	0	0	0	0	0	1	0	4	0	0	0	0	4	1	5
05:30 PM	0	0	0	2	0	1	0	0	0	0	0	12	0	0	0	1	15	1	16
05:45 PM	0	0	0	2	0	0	0	0	0	0	0	6	0	0	0	0	8	0	8
<b>Total</b>	<b>0</b>	<b>0</b>	<b>0</b>	<b>4</b>	<b>0</b>	<b>2</b>	<b>0</b>	<b>0</b>	<b>0</b>	<b>1</b>	<b>1</b>	<b>28</b>	<b>0</b>	<b>0</b>	<b>0</b>	<b>1</b>	<b>33</b>	<b>4</b>	<b>37</b>
<b>Grand Total</b>	<b>0</b>	<b>0</b>	<b>0</b>	<b>12</b>	<b>0</b>	<b>2</b>	<b>0</b>	<b>1</b>	<b>0</b>	<b>1</b>	<b>1</b>	<b>71</b>	<b>0</b>	<b>3</b>	<b>0</b>	<b>2</b>	<b>86</b>	<b>7</b>	<b>93</b>
Apprch %	0	0	0		0	100	0		0	50	50		0	100	0				
Total %	0	0	0		0	28.6	0		0	14.3	14.3		0	42.9	0		92.5	7.5	

Start Time	Hale St From North				Plymouth St From East				Welcome Center From South				Plymouth St From West				Int. Total
	Left	Thru	Right	App. Total	Left	Thru	Right	App. Total	Left	Thru	Right	App. Total	Left	Thru	Right	App. Total	
Peak Hour Analysis From 04:00 PM to 05:45 PM - Peak 1 of 1																	
Peak Hour for Entire Intersection Begins at 04:30 PM																	
04:30 PM	0	0	0	0	0	0	0	0	0	0	0	0	0	1	0	1	1
04:45 PM	0	0	0	0	0	0	0	0	0	0	0	0	0	1	0	1	1
05:00 PM	0	0	0	0	0	1	0	1	0	0	1	1	0	0	0	0	2
05:15 PM	0	0	0	0	0	0	0	0	0	1	0	1	0	0	0	0	1
<b>Total Volume</b>	<b>0</b>	<b>0</b>	<b>0</b>	<b>0</b>	<b>0</b>	<b>1</b>	<b>0</b>	<b>1</b>	<b>0</b>	<b>1</b>	<b>1</b>	<b>2</b>	<b>0</b>	<b>2</b>	<b>0</b>	<b>2</b>	<b>5</b>
<b>% App. Total</b>	<b>0</b>	<b>0</b>	<b>0</b>	<b>0</b>	<b>0</b>	<b>100</b>	<b>0</b>	<b>0</b>	<b>0</b>	<b>50</b>	<b>50</b>	<b>0</b>	<b>0</b>	<b>100</b>	<b>0</b>	<b>0</b>	<b>0</b>
PHF	.000	.000	.000	.000	.000	.250	.000	.250	.000	.250	.250	.500	.000	.500	.000	.500	.625

# Accurate Counts

978-664-2565

N/S Street : Hale Street / Welcome Center

E/W Street : Plymouth Street

City/State : Bridgewater, MA

Weather : Clear

File Name : 20270B15

Site Code : 20270015

Start Date : 10/2/2024

Page No : 11

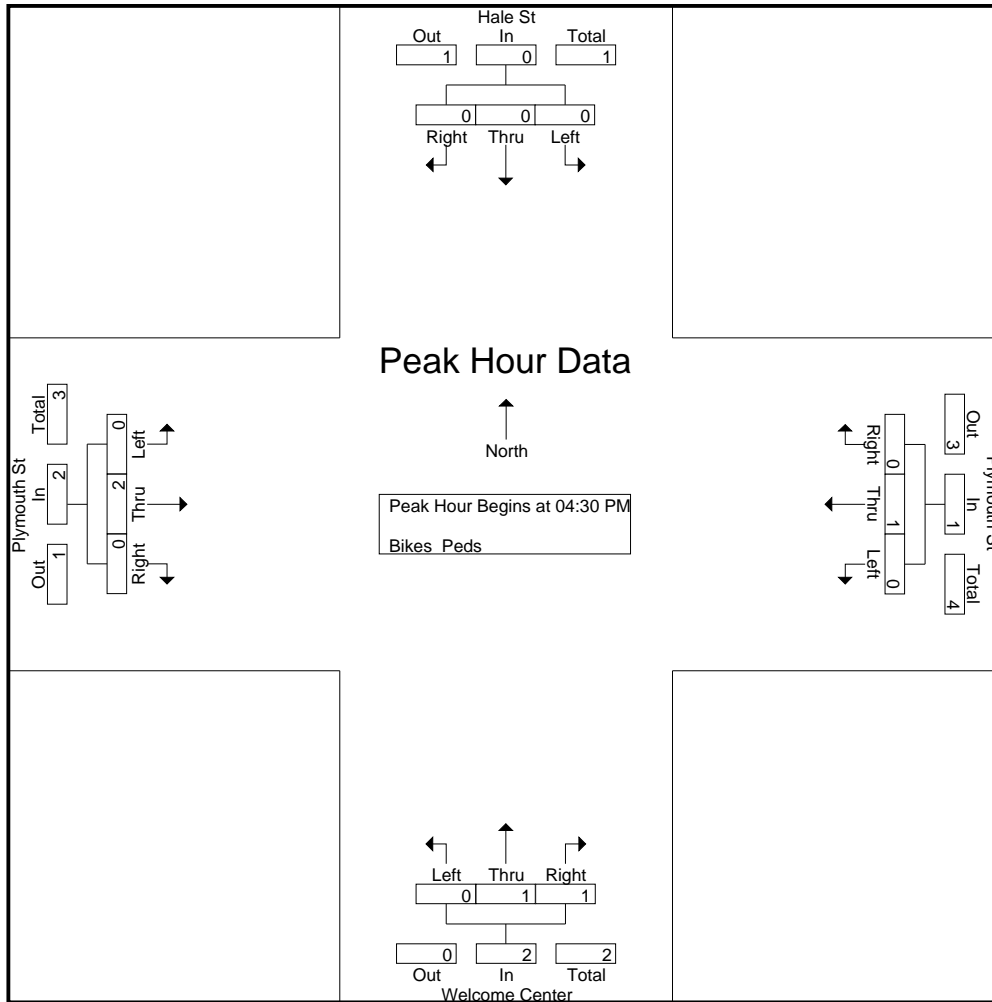

**Peak Hour Analysis From 04:00 PM to 05:45 PM - Peak 1 of 1**

**Peak Hour for Each Approach Begins at:**

	04:00 PM				04:45 PM				04:30 PM				04:00 PM			
+0 mins.	0	0	0	0	0	0	0	0	0	0	0	0	0	1	0	1
+15 mins.	0	0	0	0	0	1	0	1	0	0	0	0	0	0	0	0
+30 mins.	0	0	0	0	0	0	0	0	0	0	1	1	0	1	0	1
+45 mins.	0	0	0	0	0	1	0	1	0	1	0	1	0	1	0	1
Total Volume	0	0	0	0	0	2	0	2	0	1	1	2	0	3	0	3
% App. Total	0	0	0	0	0	100	0	0	0	50	50	0	0	100	0	0
PHF	.000	.000	.000	.000	.000	.500	.000	.500	.000	.250	.250	.500	.000	.750	.000	.750

# Accurate Counts

978-664-2565

N/S Street : Hale Street / Welcome Center

E/W Street : Plymouth Street

City/State : Bridgewater, MA

Weather : Clear

File Name : 20270B15

Site Code : 20270015

Start Date : 10/2/2024

Page No : 12

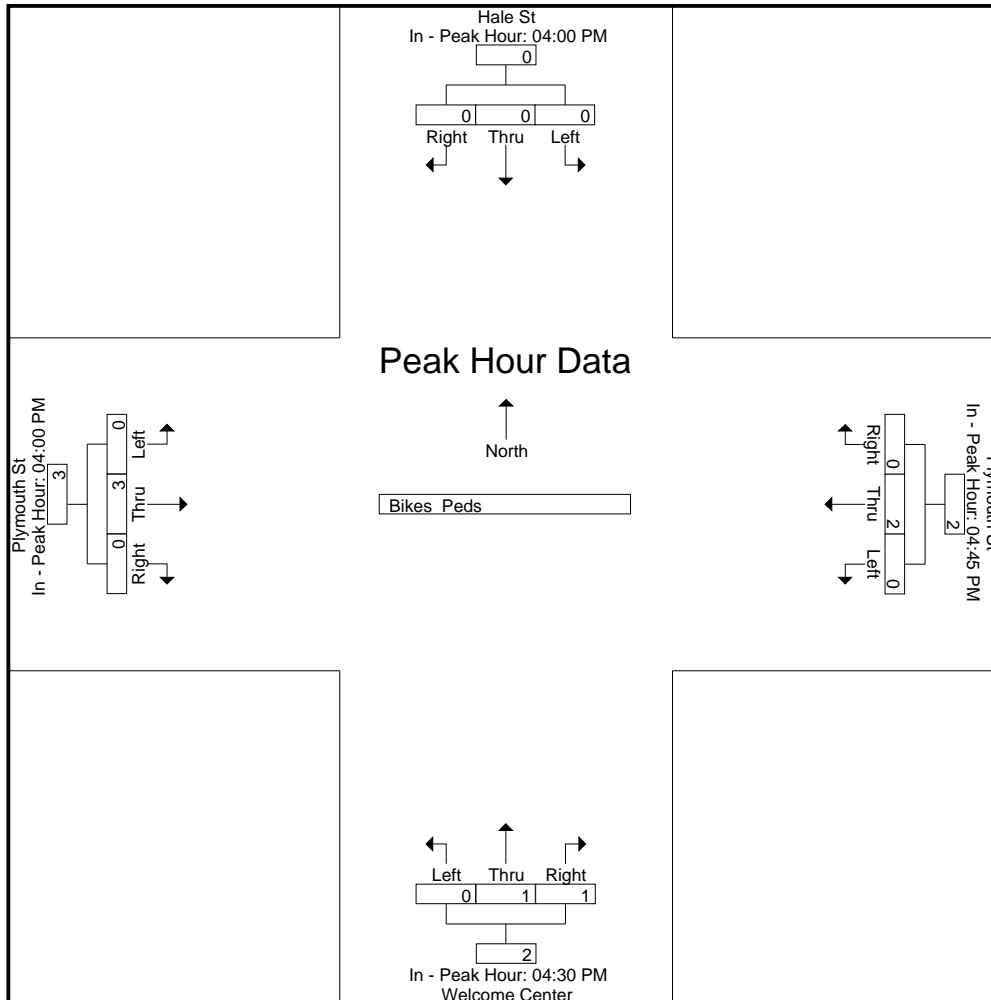



# Accurate Counts

978-664-2565

N/S Street : Burrill Avenue  
 E/W Street : Plymouth Street  
 City/State : Bridgewater, MA  
 Weather : Clear

File Name : 20270B16  
 Site Code : 20270016  
 Start Date : 10/2/2024  
 Page No : 1

### Groups Printed- Cars - Trucks

Start Time	Plymouth St From East		Burrill Ave From South		Plymouth St From West		Int. Total
	Left	Thru	Left	Right	Thru	Right	
07:00 AM	3	115	3	1	52	12	186
07:15 AM	9	98	3	1	63	24	198
07:30 AM	1	128	2	0	61	34	226
07:45 AM	7	135	0	0	66	45	253
<b>Total</b>	<b>20</b>	<b>476</b>	<b>8</b>	<b>2</b>	<b>242</b>	<b>115</b>	<b>863</b>
08:00 AM	4	106	3	1	74	24	212
08:15 AM	5	113	1	1	80	25	225
08:30 AM	9	107	3	0	76	38	233
08:45 AM	6	112	1	2	72	48	241
<b>Total</b>	<b>24</b>	<b>438</b>	<b>8</b>	<b>4</b>	<b>302</b>	<b>135</b>	<b>911</b>
<b>Grand Total</b>	<b>44</b>	<b>914</b>	<b>16</b>	<b>6</b>	<b>544</b>	<b>250</b>	<b>1774</b>
Apprch %	4.6	95.4	72.7	27.3	68.5	31.5	
Total %	2.5	51.5	0.9	0.3	30.7	14.1	
Cars	42	873	16	6	504	241	1682
% Cars	95.5	95.5	100	100	92.6	96.4	94.8
Trucks	2	41	0	0	40	9	92
% Trucks	4.5	4.5	0	0	7.4	3.6	5.2

Start Time	Plymouth St From East			Burrill Ave From South			Plymouth St From West			Int. Total
	Left	Thru	App. Total	Left	Right	App. Total	Thru	Right	App. Total	
Peak Hour Analysis From 07:00 AM to 08:45 AM - Peak 1 of 1										
Peak Hour for Entire Intersection Begins at 07:45 AM										
07:45 AM	7	<b>135</b>	<b>142</b>	0	0	0	66	<b>45</b>	111	<b>253</b>
08:00 AM	4	106	110	<b>3</b>	<b>1</b>	<b>4</b>	74	24	98	212
08:15 AM	5	113	118	1	1	2	<b>80</b>	25	105	225
08:30 AM	<b>9</b>	107	116	3	0	3	76	38	<b>114</b>	233
<b>Total Volume</b>	<b>25</b>	<b>461</b>	<b>486</b>	<b>7</b>	<b>2</b>	<b>9</b>	<b>296</b>	<b>132</b>	<b>428</b>	<b>923</b>
% App. Total	5.1	94.9		77.8	22.2		69.2	30.8		
PHF	.694	.854	.856	.583	.500	.563	.925	.733	.939	.912
Cars	23	438	461	7	2	9	273	127	400	870
% Cars	92.0	95.0	94.9	100	100	100	92.2	96.2	93.5	94.3
Trucks	2	23	25	0	0	0	23	5	28	53
% Trucks	8.0	5.0	5.1	0	0	0	7.8	3.8	6.5	5.7

# Accurate Counts

978-664-2565

N/S Street : Burrill Avenue  
 E/W Street : Plymouth Street  
 City/State : Bridgewater, MA  
 Weather : Clear

File Name : 20270B16  
 Site Code : 20270016  
 Start Date : 10/2/2024  
 Page No : 2

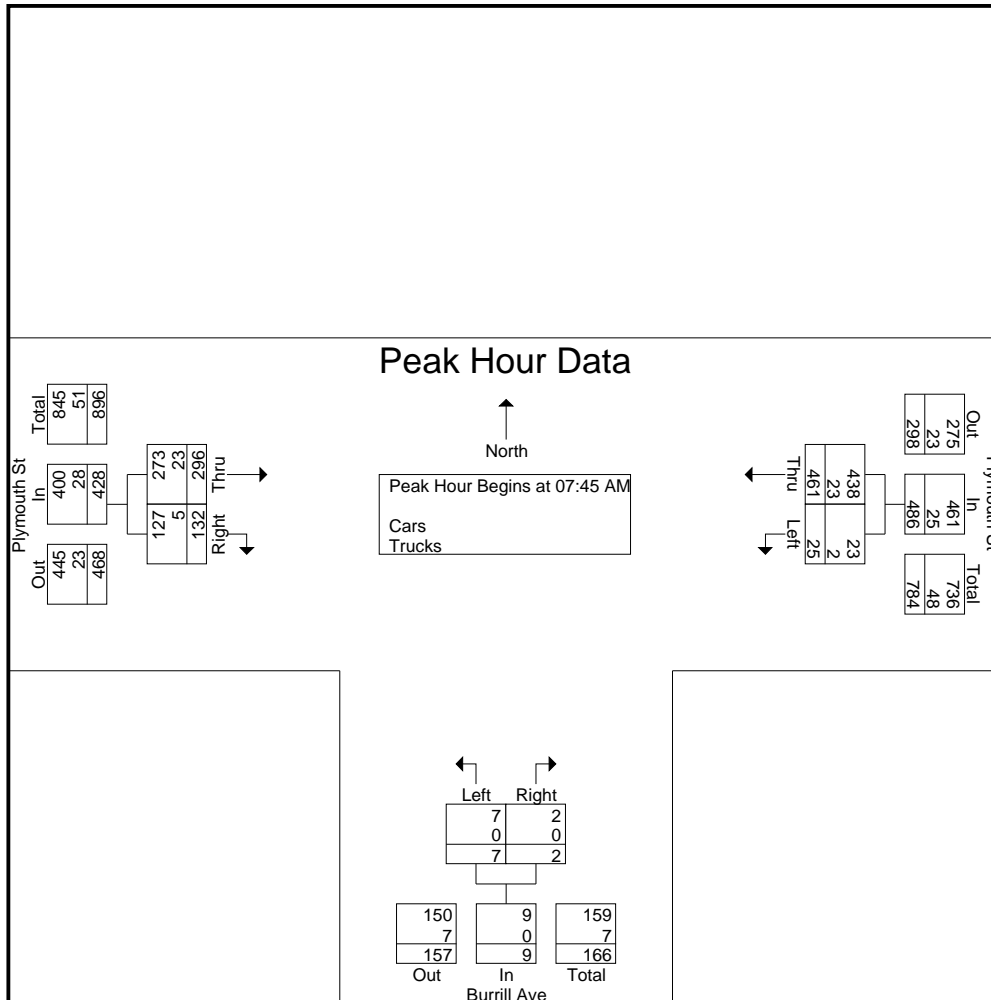

## Peak Hour Analysis From 07:00 AM to 08:45 AM - Peak 1 of 1

### Peak Hour for Each Approach Begins at:

	07:30 AM			08:00 AM			08:00 AM		
+0 mins.	1	128	129	3	1	4	74	24	98
+15 mins.	7	135	142	1	1	2	80	25	105
+30 mins.	4	106	110	3	0	3	76	38	114
+45 mins.	5	113	118	1	2	3	72	48	120
<b>Total Volume</b>	17	482	499	8	4	12	302	135	437
<b>% App. Total</b>	3.4	96.6		66.7	33.3		69.1	30.9	
PHF	.607	.893	.879	.667	.500	.750	.944	.703	.910
Cars	15	461	476	8	4	12	279	131	410
% Cars	88.2	95.6	95.4	100	100	100	92.4	97	93.8
Trucks	2	21	23	0	0	0	23	4	27
% Trucks	11.8	4.4	4.6	0	0	0	7.6	3	6.2

# Accurate Counts

978-664-2565

File Name : 20270B16

Site Code : 20270016

Start Date : 10/2/2024

Page No : 3

N/S Street : Burrill Avenue

E/W Street : Plymouth Street

City/State : Bridgewater, MA

Weather : Clear

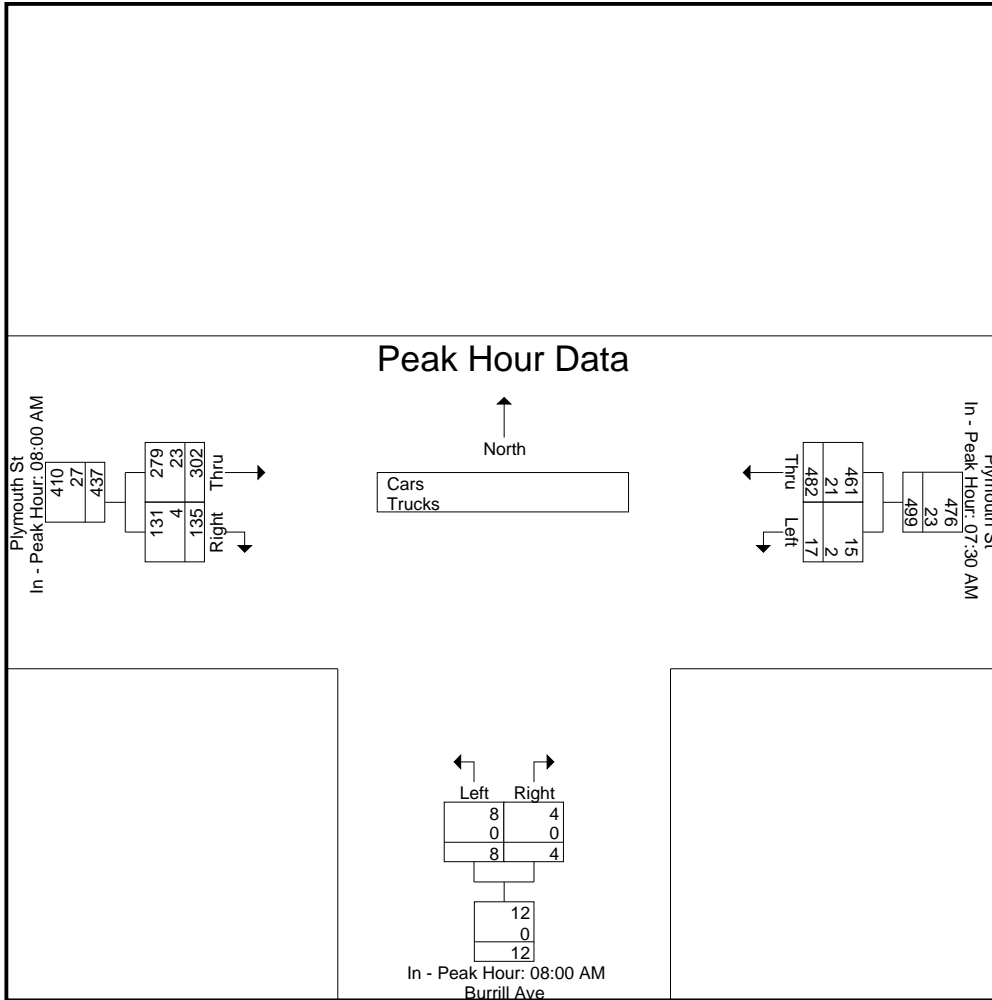

# Accurate Counts

978-664-2565

N/S Street : Burrill Avenue  
 E/W Street : Plymouth Street  
 City/State : Bridgewater, MA  
 Weather : Clear

File Name : 20270B16  
 Site Code : 20270016  
 Start Date : 10/2/2024  
 Page No : 4

## Groups Printed- Cars

Start Time	Plymouth St From East		Burrill Ave From South		Plymouth St From West		Int. Total
	Left	Thru	Left	Right	Thru	Right	
07:00 AM	3	109	3	1	48	11	175
07:15 AM	9	97	3	1	59	23	192
07:30 AM	1	125	2	0	55	33	216
07:45 AM	7	132	0	0	63	43	245
<b>Total</b>	<b>20</b>	<b>463</b>	<b>8</b>	<b>2</b>	<b>225</b>	<b>110</b>	<b>828</b>
08:00 AM	3	96	3	1	72	22	197
08:15 AM	4	108	1	1	72	24	210
08:30 AM	9	102	3	0	66	38	218
08:45 AM	6	104	1	2	69	47	229
<b>Total</b>	<b>22</b>	<b>410</b>	<b>8</b>	<b>4</b>	<b>279</b>	<b>131</b>	<b>854</b>
<b>Grand Total</b>	<b>42</b>	<b>873</b>	<b>16</b>	<b>6</b>	<b>504</b>	<b>241</b>	<b>1682</b>
Apprch %	4.6	95.4	72.7	27.3	67.7	32.3	
Total %	2.5	51.9	1	0.4	30	14.3	

Start Time	Plymouth St From East			Burrill Ave From South			Plymouth St From West			Int. Total
	Left	Thru	App. Total	Left	Right	App. Total	Thru	Right	App. Total	
Peak Hour Analysis From 07:00 AM to 08:45 AM - Peak 1 of 1										
Peak Hour for Entire Intersection Begins at 07:45 AM										
07:45 AM	7	132	139	0	0	0	63	43	106	245
08:00 AM	3	96	99	3	1	4	72	22	94	197
08:15 AM	4	108	112	1	1	2	72	24	96	210
08:30 AM	9	102	111	3	0	3	66	38	104	218
<b>Total Volume</b>	<b>23</b>	<b>438</b>	<b>461</b>	<b>7</b>	<b>2</b>	<b>9</b>	<b>273</b>	<b>127</b>	<b>400</b>	<b>870</b>
% App. Total	5	95		77.8	22.2		68.2	31.8		
PHF	.639	.830	.829	.583	.500	.563	.948	.738	.943	.888

# Accurate Counts

978-664-2565

N/S Street : Burrill Avenue  
 E/W Street : Plymouth Street  
 City/State : Bridgewater, MA  
 Weather : Clear

File Name : 20270B16  
 Site Code : 20270016  
 Start Date : 10/2/2024  
 Page No : 5

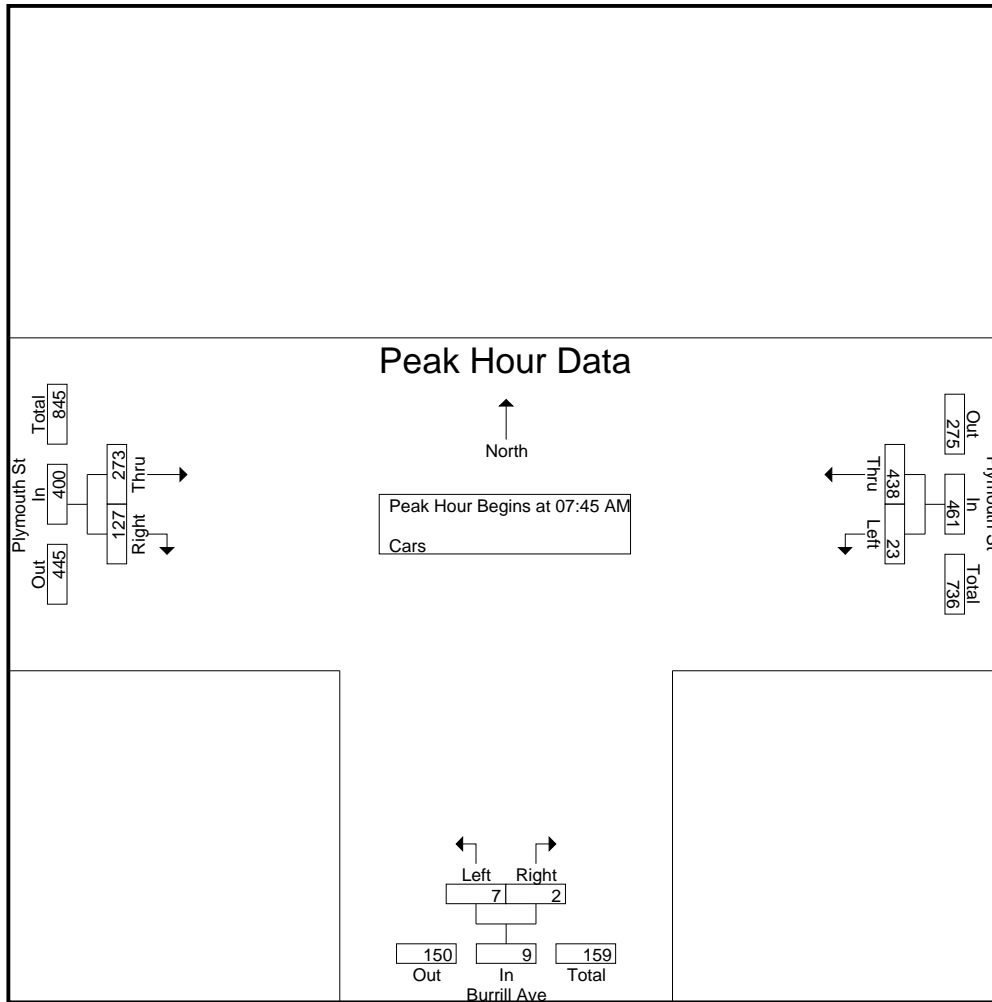

**Peak Hour Analysis From 07:00 AM to 08:45 AM - Peak 1 of 1**

Peak Hour for Each Approach Begins at:

	07:00 AM			08:00 AM			08:00 AM		
+0 mins.	3	109	112	3	1	4	72	22	94
+15 mins.	9	97	106	1	1	2	72	24	96
+30 mins.	1	125	126	3	0	3	66	38	104
+45 mins.	7	<b>132</b>	<b>139</b>	1	<b>2</b>	3	69	<b>47</b>	<b>116</b>
Total Volume	20	463	483	8	4	12	279	131	410
% App. Total	4.1	95.9		66.7	33.3		68	32	
PHF	.556	.877	.869	.667	.500	.750	.969	.697	.884

# Accurate Counts

978-664-2565

File Name : 20270B16

Site Code : 20270016

Start Date : 10/2/2024

Page No : 6

N/S Street : Burrill Avenue  
E/W Street : Plymouth Street  
City/State : Bridgewater, MA  
Weather : Clear

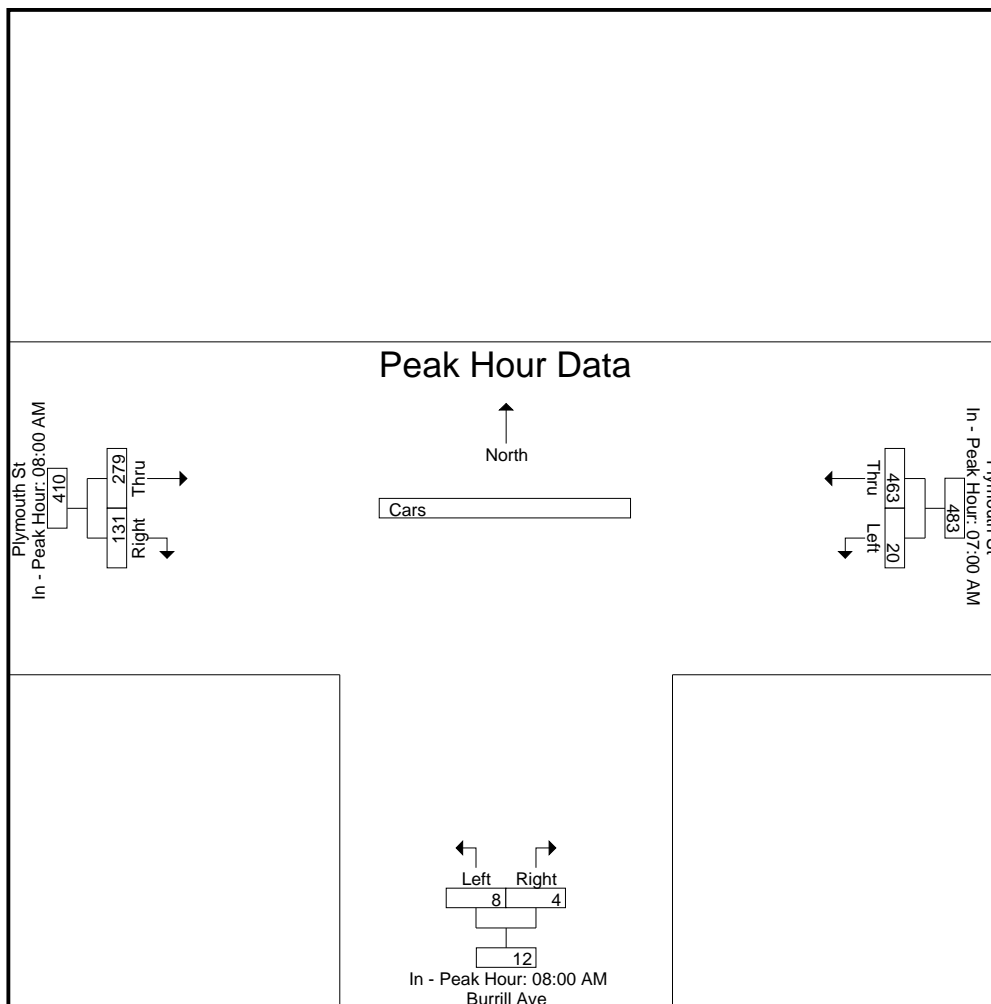

# Accurate Counts

978-664-2565

N/S Street : Burrill Avenue  
 E/W Street : Plymouth Street  
 City/State : Bridgewater, MA  
 Weather : Clear

File Name : 20270B16  
 Site Code : 20270016  
 Start Date : 10/2/2024  
 Page No : 7

### Groups Printed- Trucks

Start Time	Plymouth St From East		Burrill Ave From South		Plymouth St From West		Int. Total
	Left	Thru	Left	Right	Thru	Right	
07:00 AM	0	6	0	0	4	1	11
07:15 AM	0	1	0	0	4	1	6
07:30 AM	0	3	0	0	6	1	10
07:45 AM	0	3	0	0	3	2	8
<b>Total</b>	<b>0</b>	<b>13</b>	<b>0</b>	<b>0</b>	<b>17</b>	<b>5</b>	<b>35</b>
08:00 AM	1	10	0	0	2	2	15
08:15 AM	1	5	0	0	8	1	15
08:30 AM	0	5	0	0	10	0	15
08:45 AM	0	8	0	0	3	1	12
<b>Total</b>	<b>2</b>	<b>28</b>	<b>0</b>	<b>0</b>	<b>23</b>	<b>4</b>	<b>57</b>
<b>Grand Total</b>	<b>2</b>	<b>41</b>	<b>0</b>	<b>0</b>	<b>40</b>	<b>9</b>	<b>92</b>
Apprch %	4.7	95.3	0	0	81.6	18.4	
Total %	2.2	44.6	0	0	43.5	9.8	

Start Time	Plymouth St From East			Burrill Ave From South			Plymouth St From West			Int. Total
	Left	Thru	App. Total	Left	Right	App. Total	Thru	Right	App. Total	
Peak Hour Analysis From 07:00 AM to 08:45 AM - Peak 1 of 1										
Peak Hour for Entire Intersection Begins at 08:00 AM										
08:00 AM	1	10	11	0	0	0	2	2	4	15
08:15 AM	1	5	6	0	0	0	8	1	9	15
08:30 AM	0	5	5	0	0	0	10	0	10	15
08:45 AM	0	8	8	0	0	0	3	1	4	12
<b>Total Volume</b>	<b>2</b>	<b>28</b>	<b>30</b>	<b>0</b>	<b>0</b>	<b>0</b>	<b>23</b>	<b>4</b>	<b>27</b>	<b>57</b>
% App. Total	6.7	93.3		0	0		85.2	14.8		
PHF	.500	.700	.682	.000	.000	.000	.575	.500	.675	.950

# Accurate Counts

978-664-2565

N/S Street : Burrill Avenue  
 E/W Street : Plymouth Street  
 City/State : Bridgewater, MA  
 Weather : Clear

File Name : 20270B16  
 Site Code : 20270016  
 Start Date : 10/2/2024  
 Page No : 8

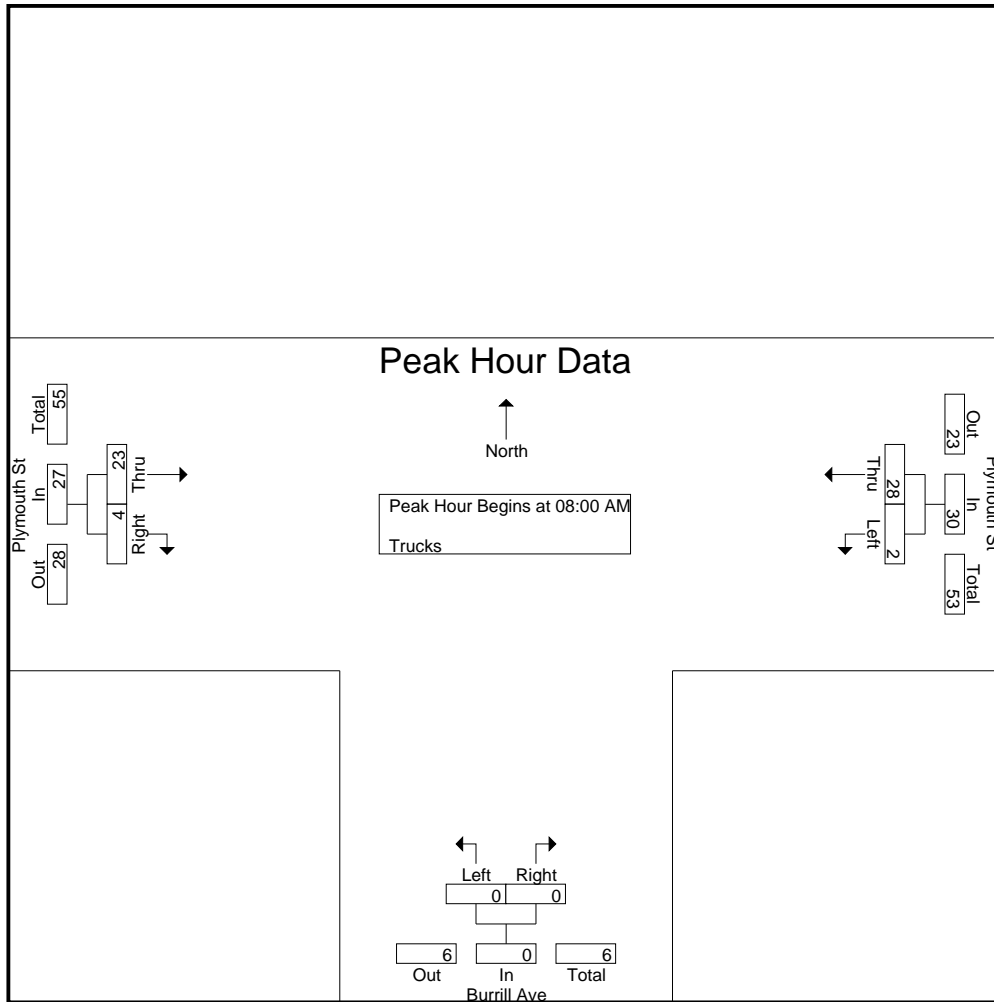

**Peak Hour Analysis From 07:00 AM to 08:45 AM - Peak 1 of 1**

Peak Hour for Each Approach Begins at:

	08:00 AM			07:00 AM			07:45 AM		
+0 mins.	1	10	11	0	0	0	3	2	5
+15 mins.	1	5	6	0	0	0	2	2	4
+30 mins.	0	5	5	0	0	0	8	1	9
+45 mins.	0	8	8	0	0	0	10	0	10
Total Volume	2	28	30	0	0	0	23	5	28
% App. Total	6.7	93.3		0	0		82.1	17.9	
PHF	.500	.700	.682	.000	.000	.000	.575	.625	.700



# Accurate Counts

978-664-2565

File Name : 20270B16

Site Code : 20270016

Start Date : 10/2/2024

Page No : 9

N/S Street : Burrill Avenue  
E/W Street : Plymouth Street  
City/State : Bridgewater, MA  
Weather : Clear

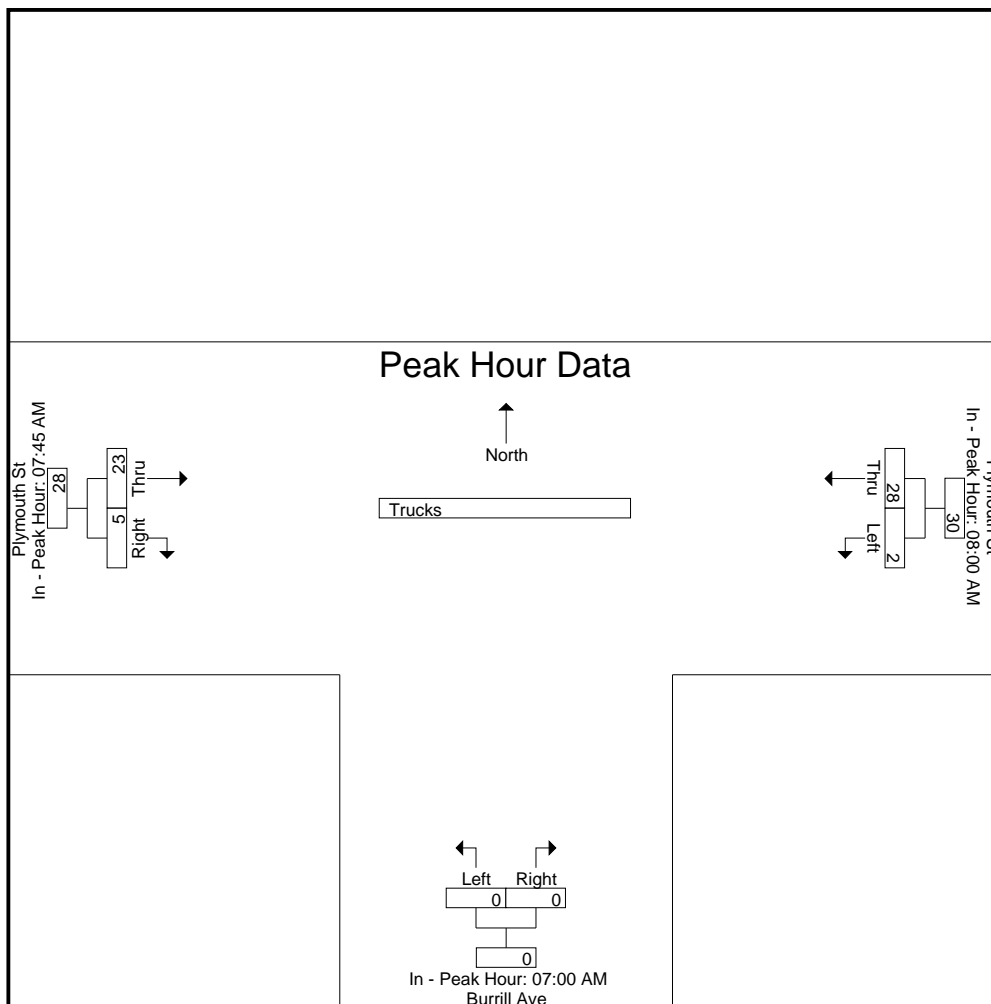

# Accurate Counts

978-664-2565

N/S Street : Burrill Avenue  
 E/W Street : Plymouth Street  
 City/State : Bridgewater, MA  
 Weather : Clear

File Name : 20270B16  
 Site Code : 20270016  
 Start Date : 10/2/2024  
 Page No : 10

### Groups Printed- Bikes Peds

Start Time	Plymouth St From East			Burrill Ave From South			Plymouth St From West			Exclu. Total	Inclu. Total	Int. Total
	Left	Thru	Peds	Left	Right	Peds	Thru	Right	Peds			
07:00 AM	0	0	0	0	0	0	1	0	0	0	1	1
07:15 AM	0	0	1	0	0	1	0	0	0	2	0	2
07:30 AM	0	0	2	0	0	2	0	1	0	4	1	5
07:45 AM	0	0	5	0	0	4	0	0	1	10	0	10
<b>Total</b>	<b>0</b>	<b>0</b>	<b>8</b>	<b>0</b>	<b>0</b>	<b>7</b>	<b>1</b>	<b>1</b>	<b>1</b>	<b>16</b>	<b>2</b>	<b>18</b>
08:00 AM	0	0	5	0	0	0	0	0	0	5	0	5
08:15 AM	0	0	0	0	0	0	0	0	1	1	0	1
08:30 AM	0	0	1	0	0	2	1	0	2	5	1	6
08:45 AM	0	0	2	0	0	1	0	0	0	3	0	3
<b>Total</b>	<b>0</b>	<b>0</b>	<b>8</b>	<b>0</b>	<b>0</b>	<b>3</b>	<b>1</b>	<b>0</b>	<b>3</b>	<b>14</b>	<b>1</b>	<b>15</b>
<b>Grand Total</b>	<b>0</b>	<b>0</b>	<b>16</b>	<b>0</b>	<b>0</b>	<b>10</b>	<b>2</b>	<b>1</b>	<b>4</b>	<b>30</b>	<b>3</b>	<b>33</b>
Apprch %	0	0		0	0		66.7	33.3				
Total %	0	0		0	0		66.7	33.3		90.9	9.1	

Start Time	Plymouth St From East			Burrill Ave From South			Plymouth St From West			Int. Total
	Left	Thru	App. Total	Left	Right	App. Total	Thru	Right	App. Total	
Peak Hour Analysis From 07:00 AM to 08:45 AM - Peak 1 of 1										
Peak Hour for Entire Intersection Begins at 07:00 AM										
07:00 AM	0	0	0	0	0	0	1	0	1	1
07:15 AM	0	0	0	0	0	0	0	0	0	0
07:30 AM	0	0	0	0	0	0	0	1	1	1
07:45 AM	0	0	0	0	0	0	0	0	0	0
<b>Total Volume</b>	<b>0</b>	<b>0</b>	<b>0</b>	<b>0</b>	<b>0</b>	<b>0</b>	<b>1</b>	<b>1</b>	<b>2</b>	<b>2</b>
<b>% App. Total</b>	<b>0</b>	<b>0</b>	<b>0</b>	<b>0</b>	<b>0</b>	<b>0</b>	<b>50</b>	<b>50</b>	<b>2</b>	<b>2</b>
<b>PHF</b>	<b>.000</b>	<b>.000</b>	<b>.000</b>	<b>.000</b>	<b>.000</b>	<b>.000</b>	<b>.250</b>	<b>.250</b>	<b>.500</b>	<b>.500</b>

# Accurate Counts

978-664-2565

N/S Street : Burrill Avenue  
 E/W Street : Plymouth Street  
 City/State : Bridgewater, MA  
 Weather : Clear

File Name : 20270B16  
 Site Code : 20270016  
 Start Date : 10/2/2024  
 Page No : 11

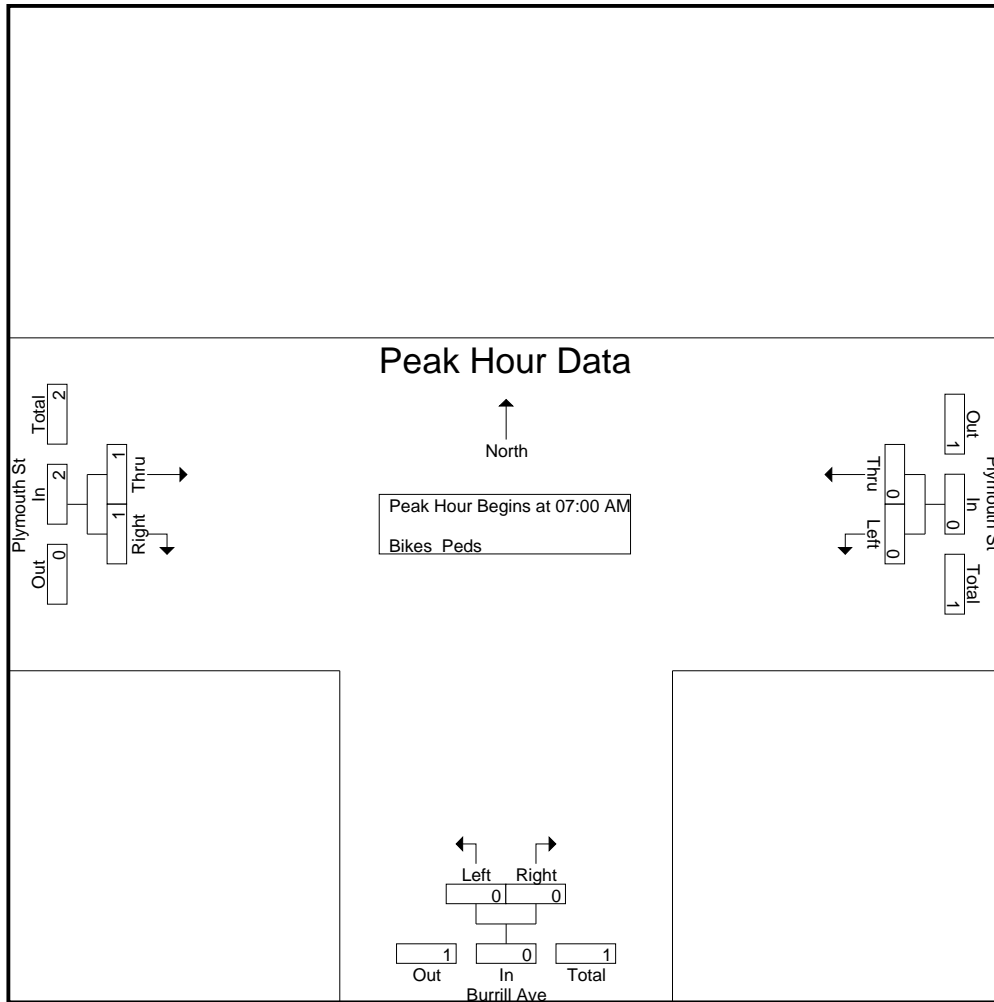

**Peak Hour Analysis From 07:00 AM to 08:45 AM - Peak 1 of 1**

Peak Hour for Each Approach Begins at:

	07:00 AM			07:00 AM			07:00 AM		
+0 mins.	0	0	0	0	0	0	1	0	1
+15 mins.	0	0	0	0	0	0	0	0	0
+30 mins.	0	0	0	0	0	0	0	1	1
+45 mins.	0	0	0	0	0	0	0	0	0
<b>Total Volume</b>	0	0	0	0	0	0	1	1	2
<b>% App. Total</b>	0	0	0	0	0	0	50	50	2
<b>PHF</b>	.000	.000	.000	.000	.000	.000	.250	.250	.500

# Accurate Counts

978-664-2565

File Name : 20270B16

Site Code : 20270016

Start Date : 10/2/2024

Page No : 12

N/S Street : Burrill Avenue  
E/W Street : Plymouth Street  
City/State : Bridgewater, MA  
Weather : Clear

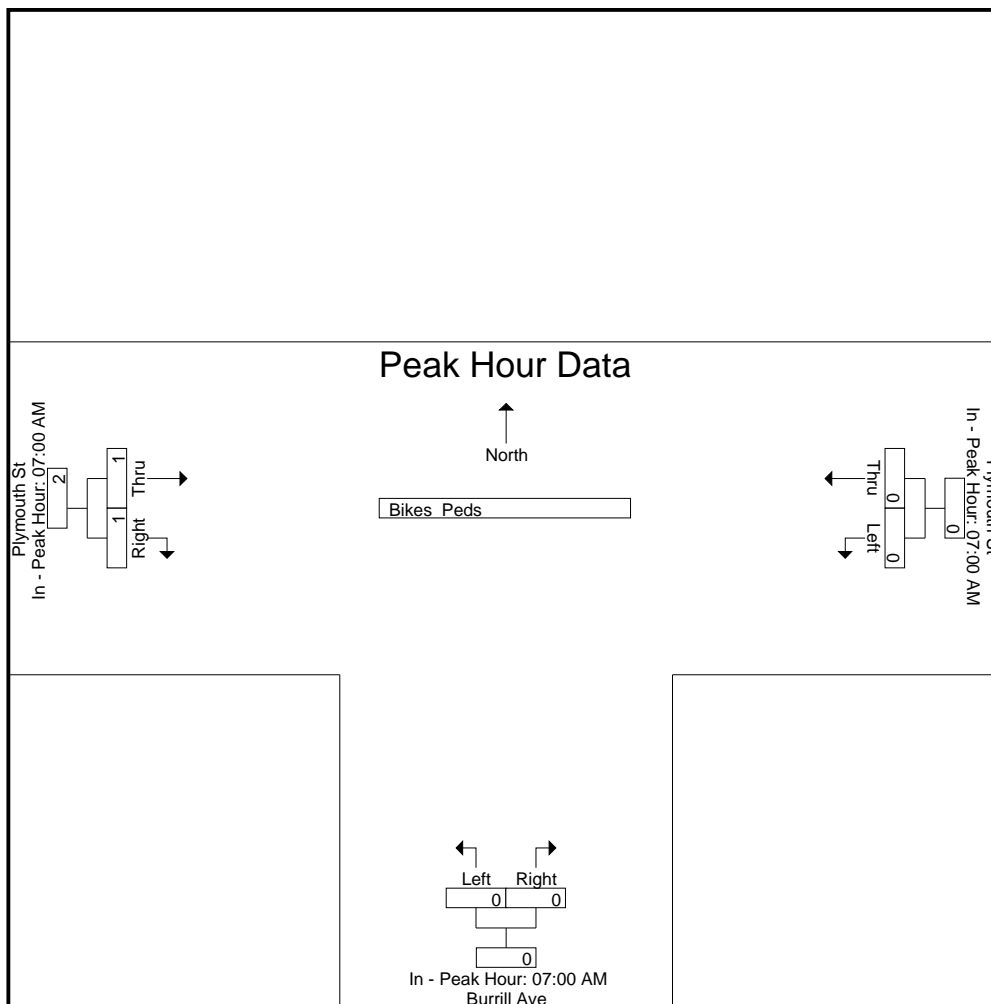

# Accurate Counts

978-664-2565

N/S Street : Burrill Avenue  
 E/W Street : Plymouth Street  
 City/State : Bridgewater, MA  
 Weather : Clear

File Name : 20270B16  
 Site Code : 20270016  
 Start Date : 10/2/2024  
 Page No : 1

### Groups Printed- Cars - Trucks

Start Time	Plymouth St From East		Burrill Ave From South		Plymouth St From West		Int. Total
	Left	Thru	Left	Right	Thru	Right	
04:00 PM	8	127	0	3	124	34	296
04:15 PM	9	133	4	1	111	29	287
04:30 PM	10	149	3	2	118	37	319
04:45 PM	11	117	3	0	134	41	306
<b>Total</b>	<b>38</b>	<b>526</b>	<b>10</b>	<b>6</b>	<b>487</b>	<b>141</b>	<b>1208</b>
05:00 PM	10	148	2	2	134	25	321
05:15 PM	4	154	2	2	120	26	308
05:30 PM	8	134	3	2	115	30	292
05:45 PM	10	160	2	2	110	25	309
<b>Total</b>	<b>32</b>	<b>596</b>	<b>9</b>	<b>8</b>	<b>479</b>	<b>106</b>	<b>1230</b>
<b>Grand Total</b>	<b>70</b>	<b>1122</b>	<b>19</b>	<b>14</b>	<b>966</b>	<b>247</b>	<b>2438</b>
Apprch %	5.9	94.1	57.6	42.4	79.6	20.4	
Total %	2.9	46	0.8	0.6	39.6	10.1	
Cars	70	1106	19	14	950	228	2387
% Cars	100	98.6	100	100	98.3	92.3	97.9
Trucks	0	16	0	0	16	19	51
% Trucks	0	1.4	0	0	1.7	7.7	2.1

Start Time	Plymouth St From East			Burrill Ave From South			Plymouth St From West			Int. Total
	Left	Thru	App. Total	Left	Right	App. Total	Thru	Right	App. Total	
Peak Hour Analysis From 04:00 PM to 05:45 PM - Peak 1 of 1										
Peak Hour for Entire Intersection Begins at 04:30 PM										
04:30 PM	10	149	<b>159</b>	<b>3</b>	<b>2</b>	<b>5</b>	118	37	155	319
04:45 PM	11	117	128	3	0	3	134	41	175	306
05:00 PM	10	148	158	2	2	4	134	25	159	321
05:15 PM	4	154	158	2	2	4	120	26	146	308
<b>Total Volume</b>	<b>35</b>	<b>568</b>	<b>603</b>	<b>10</b>	<b>6</b>	<b>16</b>	<b>506</b>	<b>129</b>	<b>635</b>	<b>1254</b>
% App. Total	5.8	94.2		62.5	37.5		79.7	20.3		
PHF	.795	.922	.948	.833	.750	.800	.944	.787	.907	.977
Cars	35	558	593	10	6	16	499	119	618	1227
% Cars	100	98.2	98.3	100	100	100	98.6	92.2	97.3	97.8
Trucks	0	10	10	0	0	0	7	10	17	27
% Trucks	0	1.8	1.7	0	0	0	1.4	7.8	2.7	2.2

# Accurate Counts

978-664-2565

N/S Street : Burrill Avenue  
 E/W Street : Plymouth Street  
 City/State : Bridgewater, MA  
 Weather : Clear

File Name : 20270B16  
 Site Code : 20270016  
 Start Date : 10/2/2024  
 Page No : 2

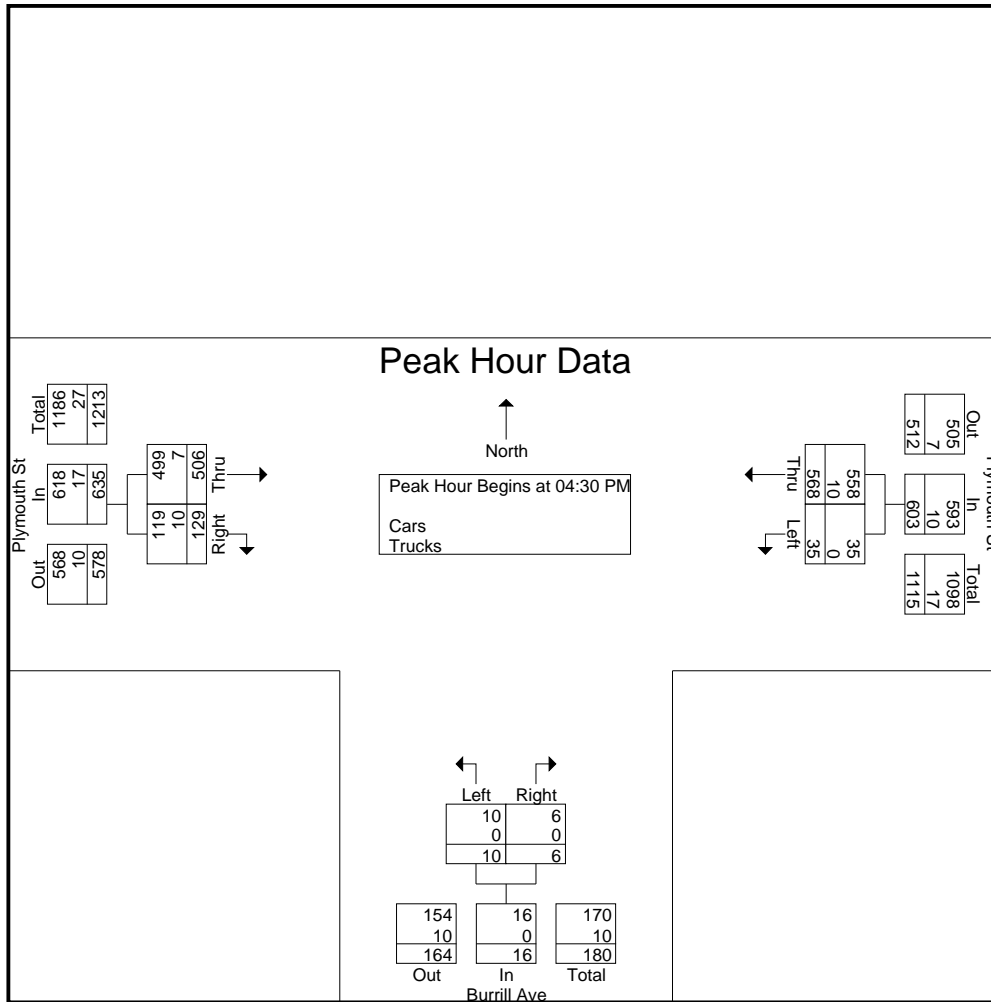

## Peak Hour Analysis From 04:00 PM to 05:45 PM - Peak 1 of 1

### Peak Hour for Each Approach Begins at:

	05:00 PM			04:15 PM			04:30 PM		
+0 mins.	<b>10</b>	148	158	<b>4</b>	1	<b>5</b>	118	37	155
+15 mins.	4	154	158	3	<b>2</b>	5	<b>134</b>	<b>41</b>	<b>175</b>
+30 mins.	8	134	142	3	0	3	134	25	159
+45 mins.	10	<b>160</b>	<b>170</b>	2	2	4	120	26	146
Total Volume	32	596	628	12	5	17	506	129	635
% App. Total	5.1	94.9		70.6	29.4		79.7	20.3	
PHF	.800	.931	.924	.750	.625	.850	.944	.787	.907
Cars	32	591	623	12	5	17	499	119	618
% Cars	100	99.2	99.2	100	100	100	98.6	92.2	97.3
Trucks	0	5	5	0	0	0	7	10	17
% Trucks	0	0.8	0.8	0	0	0	1.4	7.8	2.7

# Accurate Counts

978-664-2565

File Name : 20270B16

Site Code : 20270016

Start Date : 10/2/2024

Page No : 3

N/S Street : Burrill Avenue

E/W Street : Plymouth Street

City/State : Bridgewater, MA

Weather : Clear

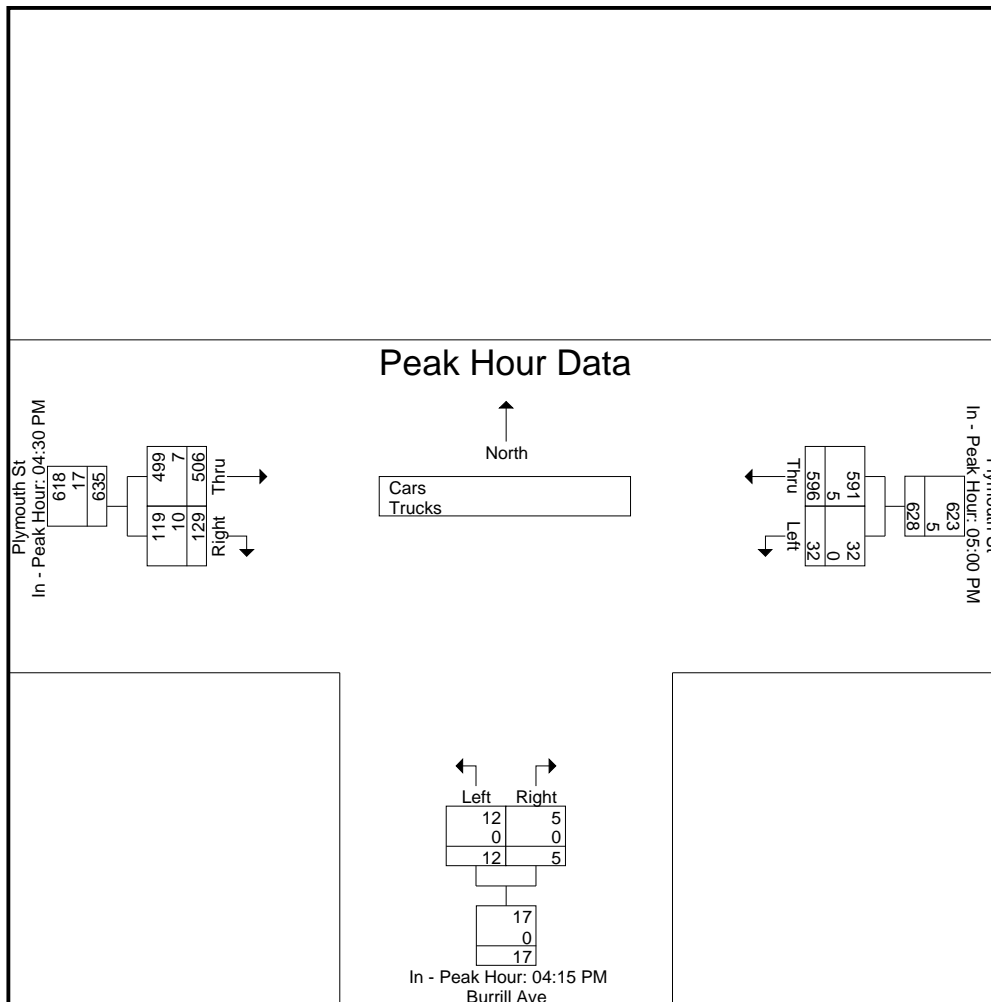

# Accurate Counts

978-664-2565

N/S Street : Burrill Avenue  
 E/W Street : Plymouth Street  
 City/State : Bridgewater, MA  
 Weather : Clear

File Name : 20270B16  
 Site Code : 20270016  
 Start Date : 10/2/2024  
 Page No : 4

### Groups Printed- Cars

Start Time	Plymouth St From East		Burrill Ave From South		Plymouth St From West		Int. Total
	Left	Thru	Left	Right	Thru	Right	
04:00 PM	8	125	0	3	120	31	287
04:15 PM	9	129	4	1	108	25	276
04:30 PM	10	146	3	2	117	35	313
04:45 PM	11	115	3	0	129	37	295
<b>Total</b>	<b>38</b>	<b>515</b>	<b>10</b>	<b>6</b>	<b>474</b>	<b>128</b>	<b>1171</b>
05:00 PM	10	145	2	2	134	23	316
05:15 PM	4	152	2	2	119	24	303
05:30 PM	8	134	3	2	114	28	289
05:45 PM	10	160	2	2	109	25	308
<b>Total</b>	<b>32</b>	<b>591</b>	<b>9</b>	<b>8</b>	<b>476</b>	<b>100</b>	<b>1216</b>
<b>Grand Total</b>	<b>70</b>	<b>1106</b>	<b>19</b>	<b>14</b>	<b>950</b>	<b>228</b>	<b>2387</b>
Apprch %	6	94	57.6	42.4	80.6	19.4	
Total %	2.9	46.3	0.8	0.6	39.8	9.6	

Start Time	Plymouth St From East			Burrill Ave From South			Plymouth St From West			Int. Total
	Left	Thru	App. Total	Left	Right	App. Total	Thru	Right	App. Total	
Peak Hour Analysis From 04:00 PM to 05:45 PM - Peak 1 of 1										
Peak Hour for Entire Intersection Begins at 04:30 PM										
04:30 PM	10	146	<b>156</b>	3	2	5	117	35	152	313
04:45 PM	11	115	126	3	0	3	129	37	166	295
05:00 PM	10	145	155	2	2	4	134	23	157	316
05:15 PM	4	152	156	2	2	4	119	24	143	303
<b>Total Volume</b>	<b>35</b>	<b>558</b>	<b>593</b>	<b>10</b>	<b>6</b>	<b>16</b>	<b>499</b>	<b>119</b>	<b>618</b>	<b>1227</b>
% App. Total	5.9	94.1		62.5	37.5		80.7	19.3		
PHF	.795	.918	.950	.833	.750	.800	.931	.804	.931	.971



# Accurate Counts

978-664-2565

N/S Street : Burrill Avenue  
 E/W Street : Plymouth Street  
 City/State : Bridgewater, MA  
 Weather : Clear

File Name : 20270B16  
 Site Code : 20270016  
 Start Date : 10/2/2024  
 Page No : 5

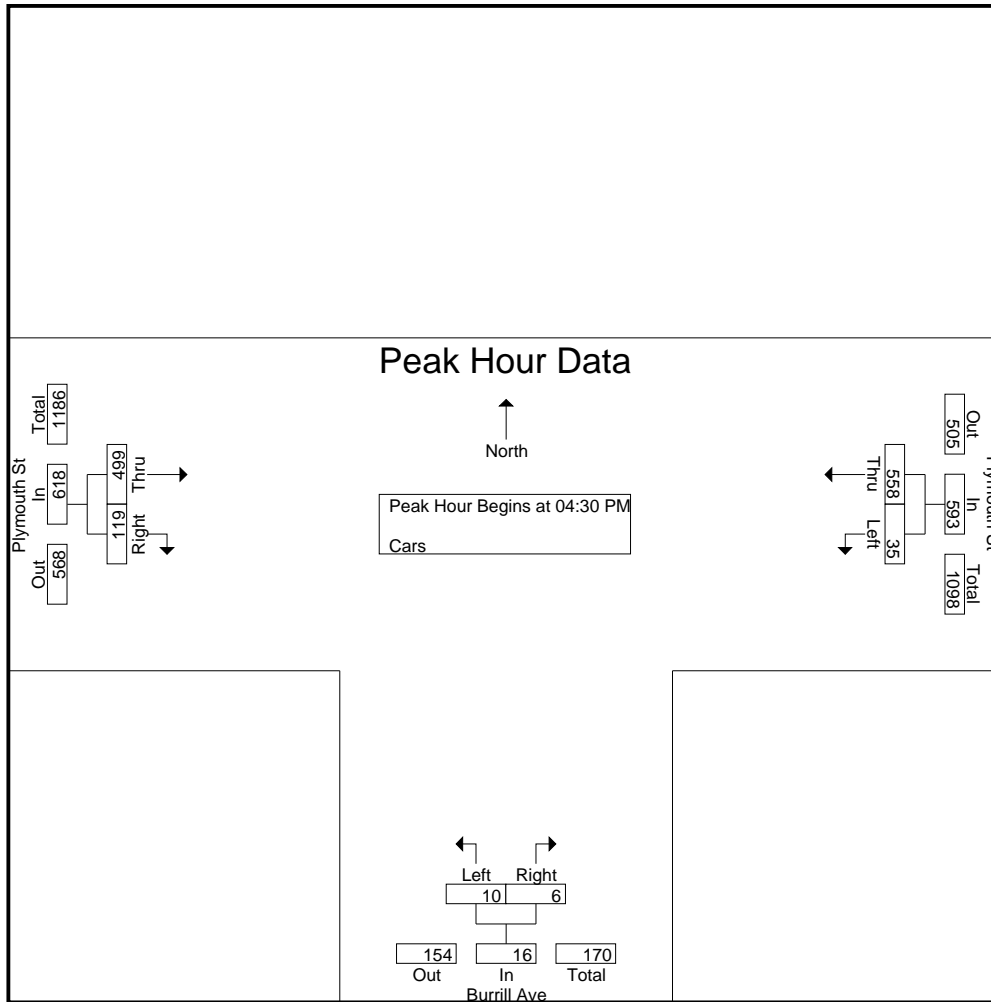

**Peak Hour Analysis From 04:00 PM to 05:45 PM - Peak 1 of 1**

Peak Hour for Each Approach Begins at:

	05:00 PM			04:15 PM			04:30 PM		
+0 mins.	10	145	155	4	1	5	117	35	152
+15 mins.	4	152	156	3	2	5	129	37	166
+30 mins.	8	134	142	3	0	3	134	23	157
+45 mins.	10	160	170	2	2	4	119	24	143
Total Volume	32	591	623	12	5	17	499	119	618
% App. Total	5.1	94.9		70.6	29.4		80.7	19.3	
PHF	.800	.923	.916	.750	.625	.850	.931	.804	.931

# Accurate Counts

978-664-2565

File Name : 20270B16

Site Code : 20270016

Start Date : 10/2/2024

Page No : 6

N/S Street : Burrill Avenue  
E/W Street : Plymouth Street  
City/State : Bridgewater, MA  
Weather : Clear

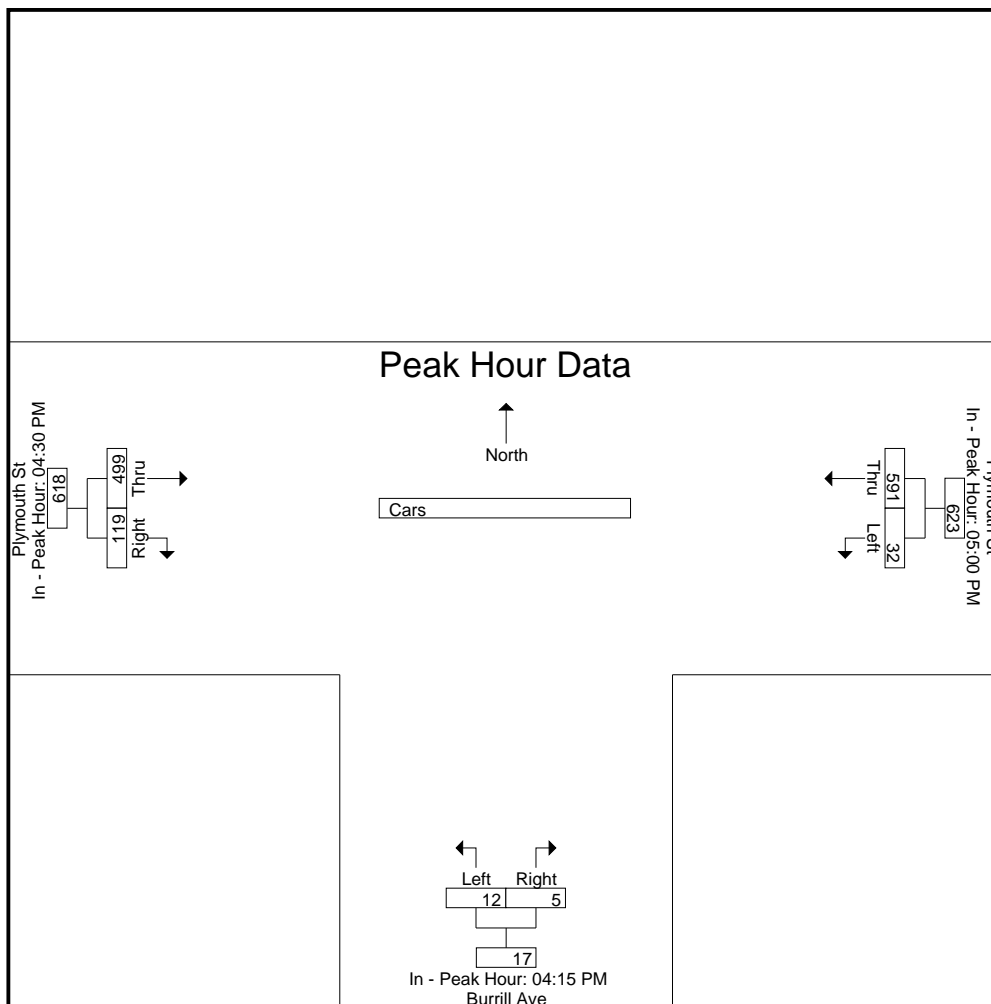

# Accurate Counts

978-664-2565

N/S Street : Burrill Avenue  
 E/W Street : Plymouth Street  
 City/State : Bridgewater, MA  
 Weather : Clear

File Name : 20270B16  
 Site Code : 20270016  
 Start Date : 10/2/2024  
 Page No : 7

### Groups Printed- Trucks

Start Time	Plymouth St From East		Burrill Ave From South		Plymouth St From West		Int. Total
	Left	Thru	Left	Right	Thru	Right	
04:00 PM	0	2	0	0	4	3	9
04:15 PM	0	4	0	0	3	4	11
04:30 PM	0	3	0	0	1	2	6
04:45 PM	0	2	0	0	5	4	11
<b>Total</b>	0	11	0	0	13	13	37
05:00 PM	0	3	0	0	0	2	5
05:15 PM	0	2	0	0	1	2	5
05:30 PM	0	0	0	0	1	2	3
05:45 PM	0	0	0	0	1	0	1
<b>Total</b>	0	5	0	0	3	6	14
<b>Grand Total</b>	0	16	0	0	16	19	51
Apprch %	0	100	0	0	45.7	54.3	
Total %	0	31.4	0	0	31.4	37.3	

Start Time	Plymouth St From East			Burrill Ave From South			Plymouth St From West			Int. Total
	Left	Thru	App. Total	Left	Right	App. Total	Thru	Right	App. Total	
Peak Hour Analysis From 04:00 PM to 05:45 PM - Peak 1 of 1										
Peak Hour for Entire Intersection Begins at 04:00 PM										
04:00 PM	0	2	2	0	0	0	4	3	7	9
04:15 PM	0	4	4	0	0	0	3	4	7	11
04:30 PM	0	3	3	0	0	0	1	2	3	6
04:45 PM	0	2	2	0	0	0	5	4	9	11
<b>Total Volume</b>	0	11	11	0	0	0	13	13	26	37
<b>% App. Total</b>	0	100		0	0		50	50		
<b>PHF</b>	.000	.688	.688	.000	.000	.000	.650	.813	.722	.841

# Accurate Counts

978-664-2565

N/S Street : Burrill Avenue  
 E/W Street : Plymouth Street  
 City/State : Bridgewater, MA  
 Weather : Clear

File Name : 20270B16  
 Site Code : 20270016  
 Start Date : 10/2/2024  
 Page No : 8

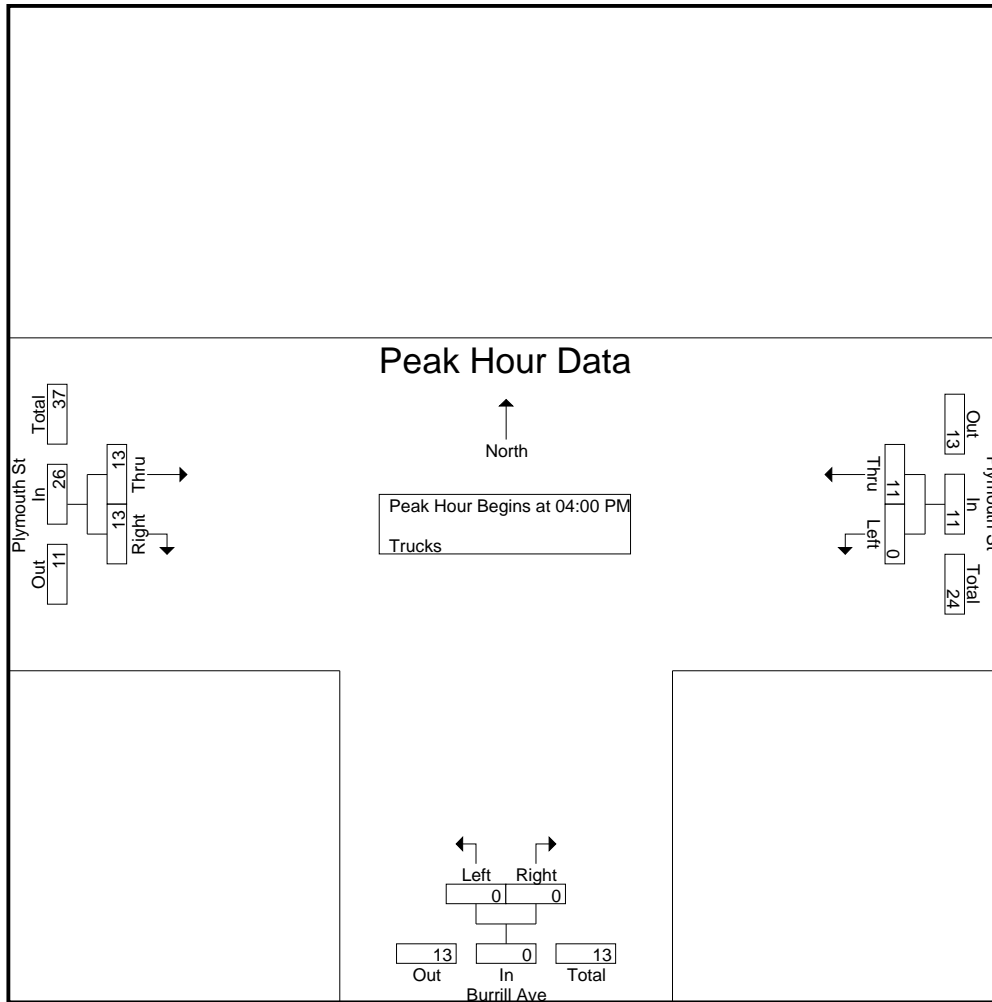

**Peak Hour Analysis From 04:00 PM to 05:45 PM - Peak 1 of 1**

Peak Hour for Each Approach Begins at:

	04:15 PM			04:00 PM			04:00 PM		
+0 mins.	0	4	4	0	0	0	4	3	7
+15 mins.	0	3	3	0	0	0	3	4	7
+30 mins.	0	2	2	0	0	0	1	2	3
+45 mins.	0	3	3	0	0	0	5	4	9
Total Volume	0	12	12	0	0	0	13	13	26
% App. Total	0	100		0	0		50	50	
PHF	.000	.750	.750	.000	.000	.000	.650	.813	.722

# Accurate Counts

978-664-2565

File Name : 20270B16

Site Code : 20270016

Start Date : 10/2/2024

Page No : 9

N/S Street : Burrill Avenue

E/W Street : Plymouth Street

City/State : Bridgewater, MA

Weather : Clear

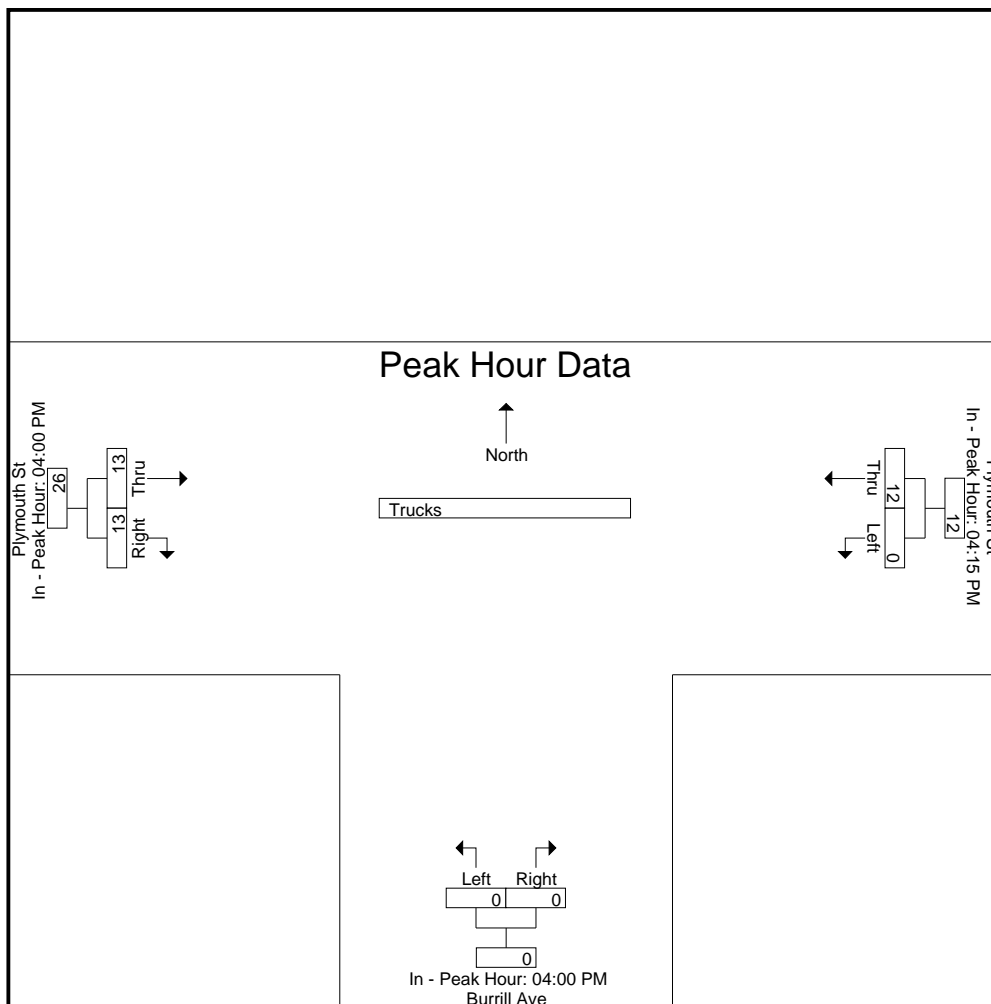

# Accurate Counts

978-664-2565

N/S Street : Burrill Avenue  
 E/W Street : Plymouth Street  
 City/State : Bridgewater, MA  
 Weather : Clear

File Name : 20270B16  
 Site Code : 20270016  
 Start Date : 10/2/2024  
 Page No : 10

## Groups Printed- Bikes Peds

Start Time	Plymouth St From East			Burrill Ave From South			Plymouth St From West			Exclu. Total	Inclu. Total	Int. Total
	Left	Thru	Peds	Left	Right	Peds	Thru	Right	Peds			
04:00 PM	0	0	1	0	0	1	0	0	0	2	0	2
04:15 PM	0	0	2	0	0	3	0	0	3	8	0	8
04:30 PM	0	0	3	0	0	2	0	0	1	6	0	6
04:45 PM	0	0	8	0	0	4	0	0	0	12	0	12
<b>Total</b>	<b>0</b>	<b>0</b>	<b>14</b>	<b>0</b>	<b>0</b>	<b>10</b>	<b>0</b>	<b>0</b>	<b>4</b>	<b>28</b>	<b>0</b>	<b>28</b>
05:00 PM	0	0	1	0	0	3	0	0	1	5	0	5
05:15 PM	0	0	1	0	0	1	0	0	0	2	0	2
05:30 PM	0	0	1	0	0	3	0	0	3	7	0	7
05:45 PM	0	0	2	0	0	3	0	1	4	9	1	10
<b>Total</b>	<b>0</b>	<b>0</b>	<b>5</b>	<b>0</b>	<b>0</b>	<b>10</b>	<b>0</b>	<b>1</b>	<b>8</b>	<b>23</b>	<b>1</b>	<b>24</b>
<b>Grand Total</b>	<b>0</b>	<b>0</b>	<b>19</b>	<b>0</b>	<b>0</b>	<b>20</b>	<b>0</b>	<b>1</b>	<b>12</b>	<b>51</b>	<b>1</b>	<b>52</b>
Apprch %	0	0		0	0		0	100				
Total %	0	0		0	0		0	100		98.1	1.9	

Start Time	Plymouth St From East			Burrill Ave From South			Plymouth St From West			Int. Total
	Left	Thru	App. Total	Left	Right	App. Total	Thru	Right	App. Total	
Peak Hour Analysis From 04:00 PM to 05:45 PM - Peak 1 of 1										
Peak Hour for Entire Intersection Begins at 05:00 PM										
05:00 PM	0	0	0	0	0	0	0	0	0	0
05:15 PM	0	0	0	0	0	0	0	0	0	0
05:30 PM	0	0	0	0	0	0	0	0	0	0
05:45 PM	0	0	0	0	0	0	0	1	1	1
<b>Total Volume</b>	<b>0</b>	<b>0</b>	<b>0</b>	<b>0</b>	<b>0</b>	<b>0</b>	<b>0</b>	<b>1</b>	<b>1</b>	<b>1</b>
<b>% App. Total</b>	<b>0</b>	<b>0</b>	<b>0</b>	<b>0</b>	<b>0</b>	<b>0</b>	<b>0</b>	<b>100</b>	<b>100</b>	<b>100</b>
<b>PHF</b>	<b>.000</b>	<b>.000</b>	<b>.000</b>	<b>.000</b>	<b>.000</b>	<b>.000</b>	<b>.000</b>	<b>.250</b>	<b>.250</b>	<b>.250</b>

# Accurate Counts

978-664-2565

N/S Street : Burrill Avenue  
 E/W Street : Plymouth Street  
 City/State : Bridgewater, MA  
 Weather : Clear

File Name : 20270B16  
 Site Code : 20270016  
 Start Date : 10/2/2024  
 Page No : 11

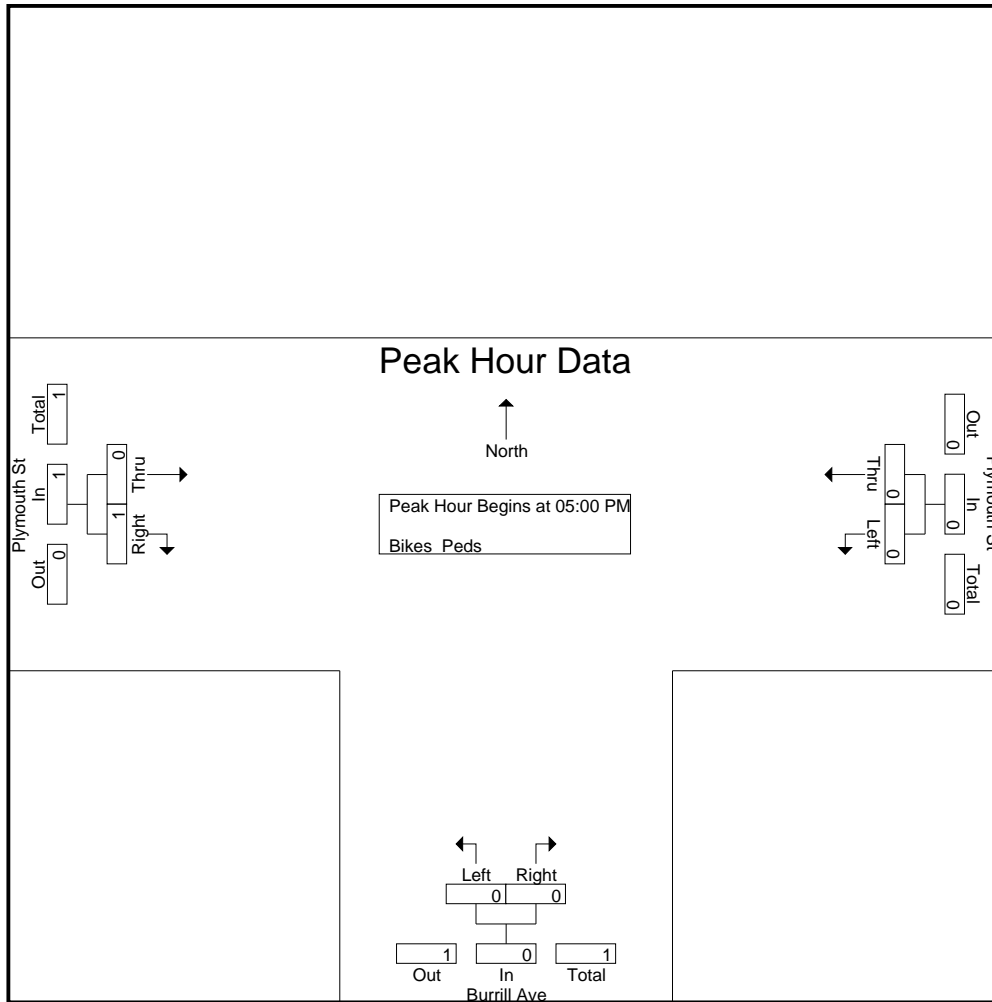

**Peak Hour Analysis From 04:00 PM to 05:45 PM - Peak 1 of 1**

Peak Hour for Each Approach Begins at:

	04:00 PM			04:00 PM			05:00 PM		
+0 mins.	0	0	0	0	0	0	0	0	0
+15 mins.	0	0	0	0	0	0	0	0	0
+30 mins.	0	0	0	0	0	0	0	0	0
+45 mins.	0	0	0	0	0	0	0	1	1
Total Volume	0	0	0	0	0	0	0	1	1
% App. Total	0	0	0	0	0	0	0	100	100
PHF	.000	.000	.000	.000	.000	.000	.000	.250	.250

# Accurate Counts

978-664-2565

File Name : 20270B16

Site Code : 20270016

Start Date : 10/2/2024

Page No : 12

N/S Street : Burrill Avenue

E/W Street : Plymouth Street

City/State : Bridgewater, MA

Weather : Clear

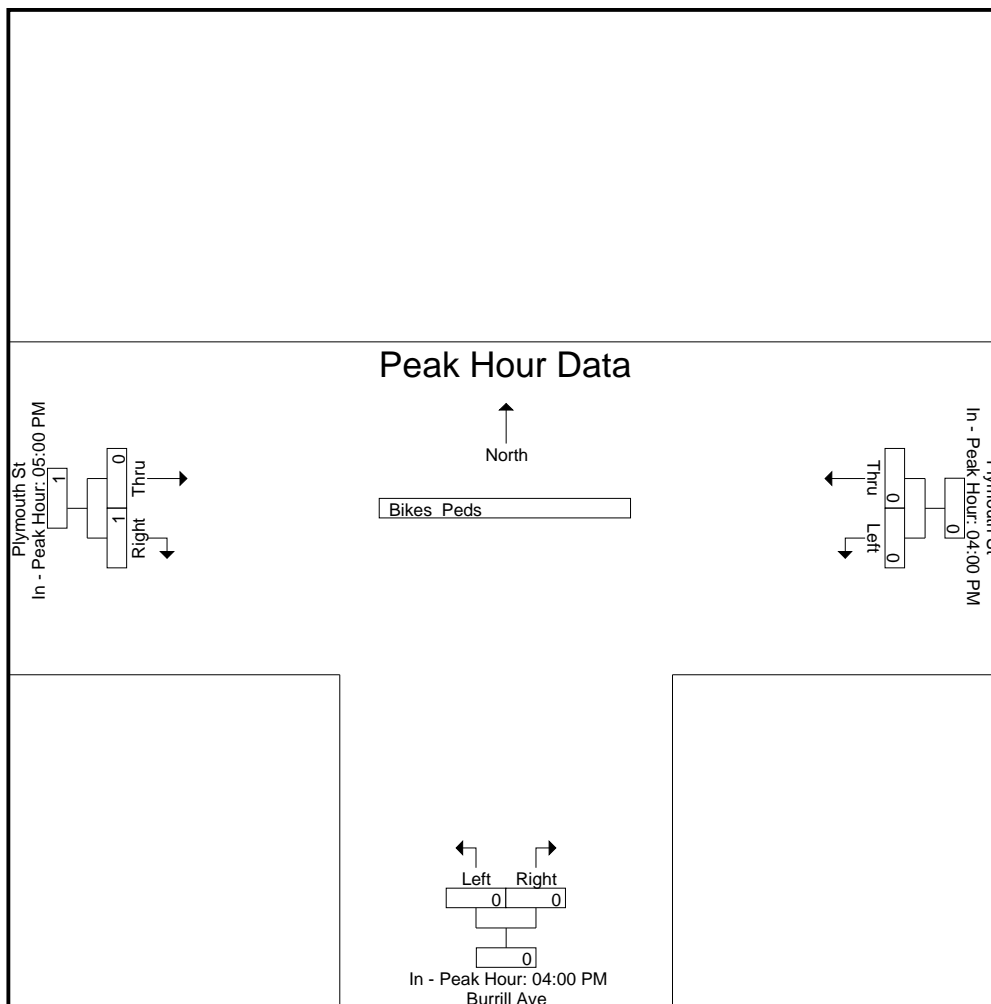



# Accurate Counts

978-664-2565

N/S Street : Spring St / Sapper St  
 E/W Street : Plymouth Street  
 City/State : Bridgewater, MA  
 Weather : Clear

File Name : 20270B17  
 Site Code : 20270017  
 Start Date : 10/2/2024  
 Page No : 1

### Groups Printed- Cars - Trucks

Start Time	Spring St From North			Plymouth St From East			Sapper St From South			Plymouth St From West			Int. Total
	Left	Thru	Right	Left	Thru	Right	Left	Thru	Right	Left	Thru	Right	
07:00 AM	5	0	7	0	107	34	1	0	0	6	47	1	208
07:15 AM	17	0	10	1	96	42	0	0	0	8	54	0	228
07:30 AM	19	0	11	0	106	43	0	0	0	7	53	0	239
07:45 AM	24	0	16	0	121	44	1	0	0	7	51	0	264
<b>Total</b>	<b>65</b>	<b>0</b>	<b>44</b>	<b>1</b>	<b>430</b>	<b>163</b>	<b>2</b>	<b>0</b>	<b>0</b>	<b>28</b>	<b>205</b>	<b>1</b>	<b>939</b>
08:00 AM	23	0	11	0	101	44	1	0	0	10	66	0	256
08:15 AM	20	0	13	0	100	27	0	0	0	9	71	0	240
08:30 AM	17	0	10	0	97	42	1	0	0	5	63	0	235
08:45 AM	27	0	10	0	119	49	0	0	0	10	54	1	270
<b>Total</b>	<b>87</b>	<b>0</b>	<b>44</b>	<b>0</b>	<b>417</b>	<b>162</b>	<b>2</b>	<b>0</b>	<b>0</b>	<b>34</b>	<b>254</b>	<b>1</b>	<b>1001</b>
<b>Grand Total</b>	<b>152</b>	<b>0</b>	<b>88</b>	<b>1</b>	<b>847</b>	<b>325</b>	<b>4</b>	<b>0</b>	<b>0</b>	<b>62</b>	<b>459</b>	<b>2</b>	<b>1940</b>
Apprch %	63.3	0	36.7	0.1	72.2	27.7	100	0	0	11.9	87.8	0.4	
Total %	7.8	0	4.5	0.1	43.7	16.8	0.2	0	0	3.2	23.7	0.1	
Cars	151	0	85	1	800	315	4	0	0	62	425	2	1845
% Cars	99.3	0	96.6	100	94.5	96.9	100	0	0	100	92.6	100	95.1
Trucks	1	0	3	0	47	10	0	0	0	0	34	0	95
% Trucks	0.7	0	3.4	0	5.5	3.1	0	0	0	0	7.4	0	4.9

Start Time	Spring St From North				Plymouth St From East				Sapper St From South				Plymouth St From West				Int. Total
	Left	Thru	Right	App. Total	Left	Thru	Right	App. Total	Left	Thru	Right	App. Total	Left	Thru	Right	App. Total	
Peak Hour Analysis From 07:00 AM to 08:45 AM - Peak 1 of 1																	
Peak Hour for Entire Intersection Begins at 08:00 AM																	
08:00 AM	23	0	11	34	0	101	44	145	1	0	0	1	10	66	0	76	256
08:15 AM	20	0	13	33	0	100	27	127	0	0	0	0	9	71	0	80	240
08:30 AM	17	0	10	27	0	97	42	139	1	0	0	1	5	63	0	68	235
08:45 AM	27	0	10	37	0	119	49	168	0	0	0	0	10	54	1	65	270
<b>Total Volume</b>	<b>87</b>	<b>0</b>	<b>44</b>	<b>131</b>	<b>0</b>	<b>417</b>	<b>162</b>	<b>579</b>	<b>2</b>	<b>0</b>	<b>0</b>	<b>2</b>	<b>34</b>	<b>254</b>	<b>1</b>	<b>289</b>	<b>1001</b>
% App. Total	66.4	0	33.6		0	72	28		100	0	0		11.8	87.9	0.3		
PHF	.806	.000	.846	.885	.000	.876	.827	.862	.500	.000	.000	.500	.850	.894	.250	.903	.927
Cars	86	0	41	127	0	385	156	541	2	0	0	2	34	233	1	268	938
% Cars	98.9	0	93.2	96.9	0	92.3	96.3	93.4	100	0	0	100	100	91.7	100	92.7	93.7
Trucks	1	0	3	4	0	32	6	38	0	0	0	0	0	21	0	21	63
% Trucks	1.1	0	6.8	3.1	0	7.7	3.7	6.6	0	0	0	0	0	8.3	0	7.3	6.3

# Accurate Counts

978-664-2565

N/S Street : Spring St / Sapper St

E/W Street : Plymouth Street

City/State : Bridgewater, MA

Weather : Clear

File Name : 20270B17

Site Code : 20270017

Start Date : 10/2/2024

Page No : 2

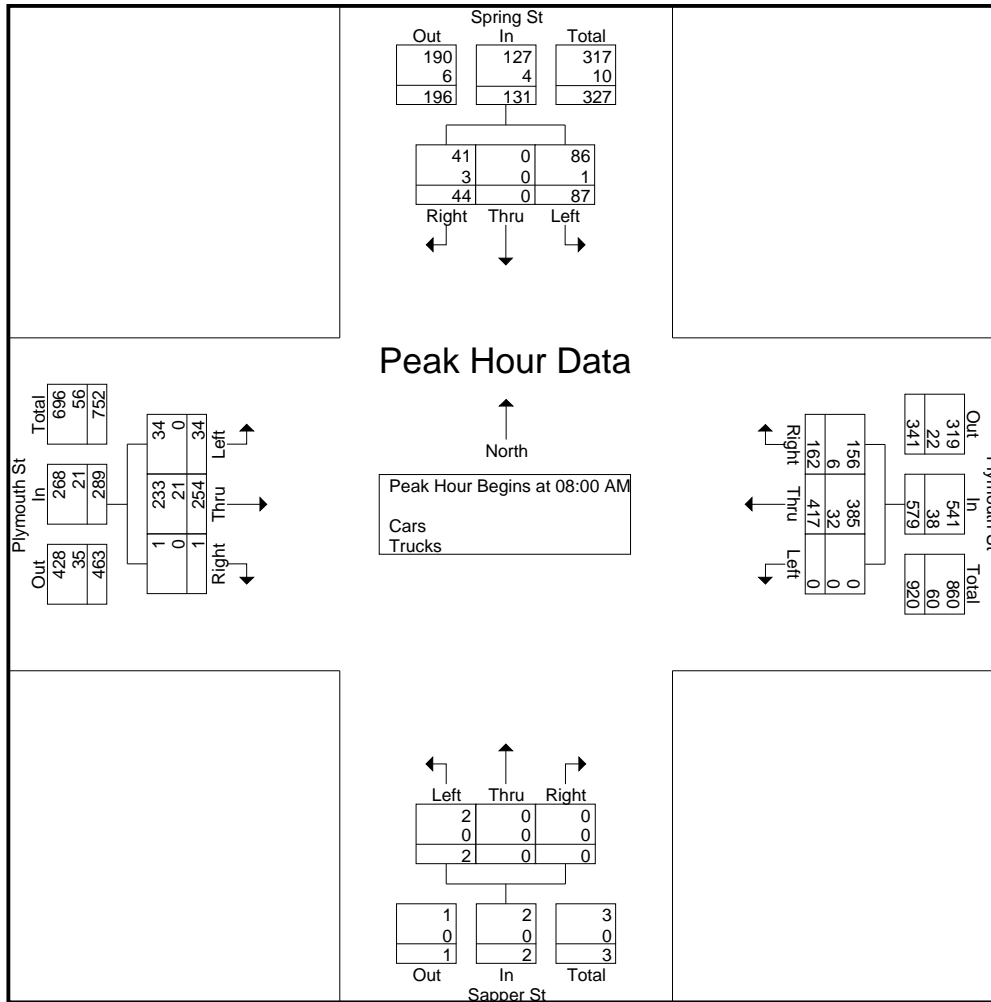

**Peak Hour Analysis From 07:00 AM to 08:45 AM - Peak 1 of 1**

**Peak Hour for Each Approach Begins at:**

	07:30 AM				07:15 AM				07:45 AM				08:00 AM			
+0 mins.	19	0	11	30	1	96	42	139	1	0	0	1	10	66	0	76
+15 mins.	24	0	16	40	0	106	43	149	1	0	0	1	9	71	0	80
+30 mins.	23	0	11	34	0	121	44	165	0	0	0	0	5	63	0	68
+45 mins.	20	0	13	33	0	101	44	145	1	0	0	1	10	54	1	65
Total Volume	86	0	51	137	1	424	173	598	3	0	0	3	34	254	1	289
% App. Total	62.8	0	37.2		0.2	70.9	28.9		100	0	0		11.8	87.9	0.3	
PHF	.896	.000	.797	.856	.250	.876	.983	.906	.750	.000	.000	.750	.850	.894	.250	.903
Cars	85	0	48	133	1	406	169	576	3	0	0	3	34	233	1	268
% Cars	98.8	0	94.1	97.1	100	95.8	97.7	96.3	100	0	0	100	100	91.7	100	92.7
Trucks	1	0	3	4	0	18	4	22	0	0	0	0	0	21	0	21
% Trucks	1.2	0	5.9	2.9	0	4.2	2.3	3.7	0	0	0	0	0	8.3	0	7.3

# Accurate Counts

978-664-2565

N/S Street : Spring St / Sapper St

E/W Street : Plymouth Street

City/State : Bridgewater, MA

Weather : Clear

File Name : 20270B17

Site Code : 20270017

Start Date : 10/2/2024

Page No : 3

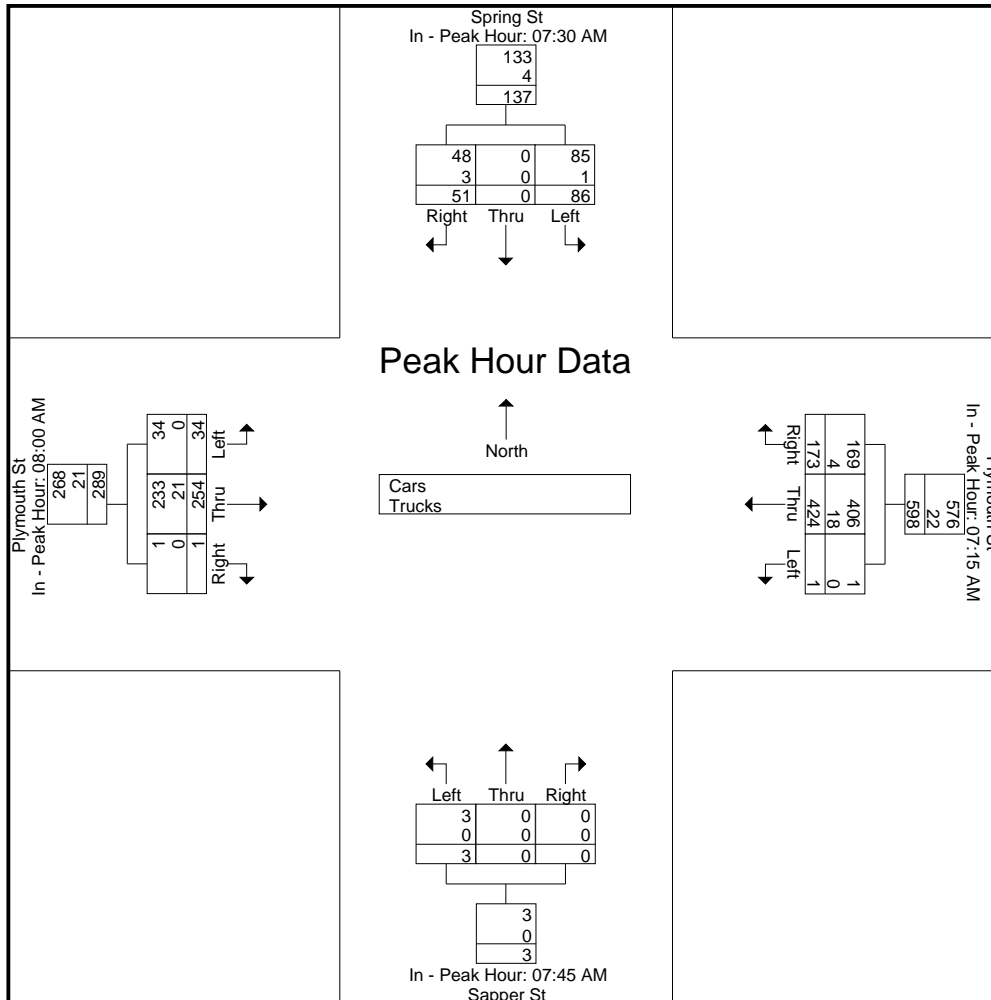

# Accurate Counts

978-664-2565

N/S Street : Spring St / Sapper St  
 E/W Street : Plymouth Street  
 City/State : Bridgewater, MA  
 Weather : Clear

File Name : 20270B17  
 Site Code : 20270017  
 Start Date : 10/2/2024  
 Page No : 4

## Groups Printed- Cars

Start Time	Spring St From North			Plymouth St From East			Sapper St From South			Plymouth St From West			Int. Total
	Left	Thru	Right	Left	Thru	Right	Left	Thru	Right	Left	Thru	Right	
07:00 AM	5	0	7	0	101	33	1	0	0	6	44	1	198
07:15 AM	17	0	10	1	94	41	0	0	0	8	50	0	221
07:30 AM	19	0	11	0	103	42	0	0	0	7	49	0	231
07:45 AM	24	0	16	0	117	43	1	0	0	7	49	0	257
<b>Total</b>	<b>65</b>	<b>0</b>	<b>44</b>	<b>1</b>	<b>415</b>	<b>159</b>	<b>2</b>	<b>0</b>	<b>0</b>	<b>28</b>	<b>192</b>	<b>1</b>	<b>907</b>
08:00 AM	23	0	9	0	92	43	1	0	0	10	64	0	242
08:15 AM	19	0	12	0	94	25	0	0	0	9	64	0	223
08:30 AM	17	0	10	0	93	40	1	0	0	5	53	0	219
08:45 AM	27	0	10	0	106	48	0	0	0	10	52	1	254
<b>Total</b>	<b>86</b>	<b>0</b>	<b>41</b>	<b>0</b>	<b>385</b>	<b>156</b>	<b>2</b>	<b>0</b>	<b>0</b>	<b>34</b>	<b>233</b>	<b>1</b>	<b>938</b>
<b>Grand Total</b>	<b>151</b>	<b>0</b>	<b>85</b>	<b>1</b>	<b>800</b>	<b>315</b>	<b>4</b>	<b>0</b>	<b>0</b>	<b>62</b>	<b>425</b>	<b>2</b>	<b>1845</b>
Apprch %	64	0	36	0.1	71.7	28.2	100	0	0	12.7	86.9	0.4	
Total %	8.2	0	4.6	0.1	43.4	17.1	0.2	0	0	3.4	23	0.1	

Start Time	Spring St From North				Plymouth St From East				Sapper St From South				Plymouth St From West				Int. Total
	Left	Thru	Right	App. Total	Left	Thru	Right	App. Total	Left	Thru	Right	App. Total	Left	Thru	Right	App. Total	
<b>Peak Hour Analysis From 07:00 AM to 08:45 AM - Peak 1 of 1</b>																	
<b>Peak Hour for Entire Intersection Begins at 07:30 AM</b>																	
07:30 AM	19	0	11	30	0	103	42	145	0	0	0	0	7	49	0	56	231
07:45 AM	<b>24</b>	<b>0</b>	<b>16</b>	<b>40</b>	<b>0</b>	<b>117</b>	<b>43</b>	<b>160</b>	<b>1</b>	<b>0</b>	<b>0</b>	<b>1</b>	<b>7</b>	<b>49</b>	<b>0</b>	<b>56</b>	<b>257</b>
08:00 AM	23	0	9	32	0	92	43	135	1	0	0	1	<b>10</b>	<b>64</b>	0	<b>74</b>	242
08:15 AM	19	0	12	31	0	94	25	119	0	0	0	0	9	64	0	73	223
<b>Total Volume</b>	<b>85</b>	<b>0</b>	<b>48</b>	<b>133</b>	<b>0</b>	<b>406</b>	<b>153</b>	<b>559</b>	<b>2</b>	<b>0</b>	<b>0</b>	<b>2</b>	<b>33</b>	<b>226</b>	<b>0</b>	<b>259</b>	<b>953</b>
<b>% App. Total</b>	<b>63.9</b>	<b>0</b>	<b>36.1</b>		<b>0</b>	<b>72.6</b>	<b>27.4</b>		<b>100</b>	<b>0</b>	<b>0</b>		<b>12.7</b>	<b>87.3</b>	<b>0</b>		
PHF	.885	.000	.750	.831	.000	.868	.890	.873	.500	.000	.000	.500	.825	.883	.000	.875	.927

# Accurate Counts

978-664-2565

N/S Street : Spring St / Sapper St

E/W Street : Plymouth Street

City/State : Bridgewater, MA

Weather : Clear

File Name : 20270B17

Site Code : 20270017

Start Date : 10/2/2024

Page No : 5

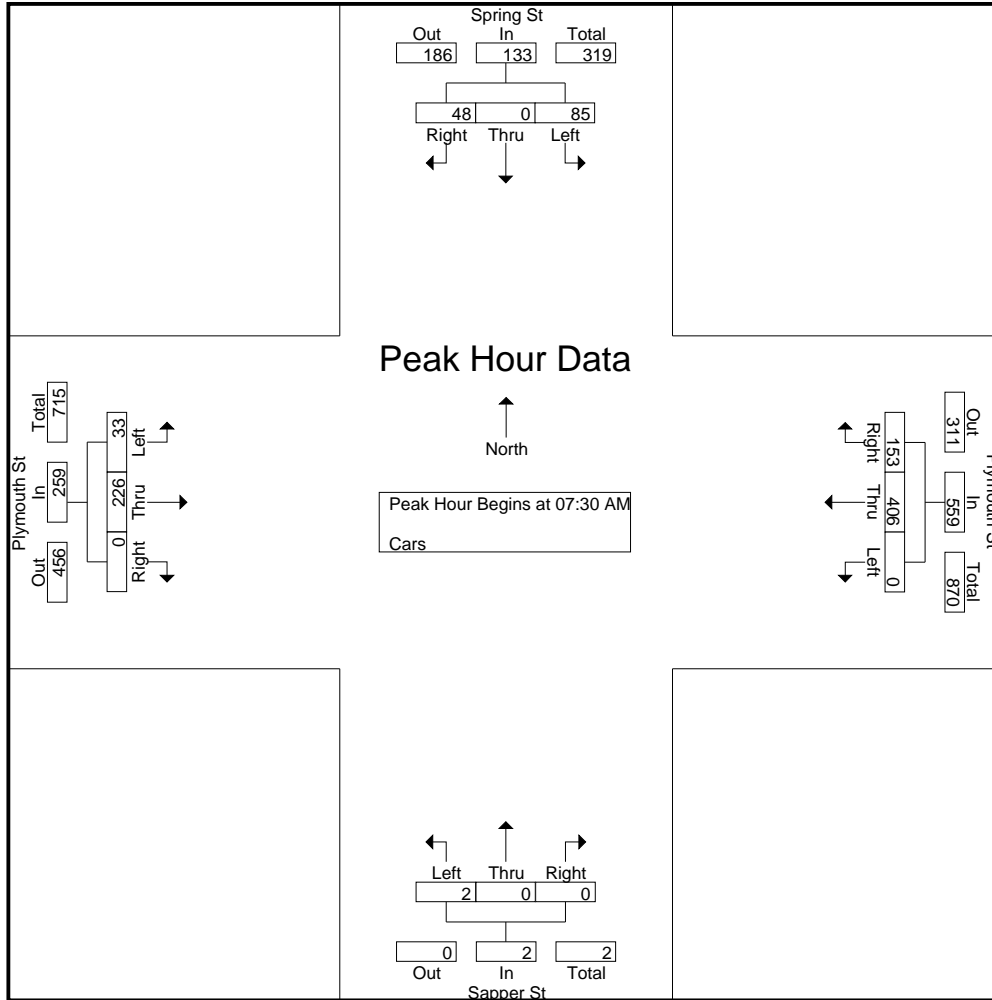

**Peak Hour Analysis From 07:00 AM to 08:45 AM - Peak 1 of 1**

**Peak Hour for Each Approach Begins at:**

	07:30 AM				07:15 AM				07:45 AM				08:00 AM			
+0 mins.	19	0	11	30	1	94	41	136	1	0	0	1	10	64	0	74
+15 mins.	24	0	16	40	0	103	42	145	1	0	0	1	9	64	0	73
+30 mins.	23	0	9	32	0	117	43	160	0	0	0	0	5	53	0	58
+45 mins.	19	0	12	31	0	92	43	135	1	0	0	1	10	52	1	63
<b>Total Volume</b>	85	0	48	133	1	406	169	576	3	0	0	3	34	233	1	268
<b>% App. Total</b>	63.9	0	36.1		0.2	70.5	29.3		100	0	0		12.7	86.9	0.4	
<b>PHF</b>	.885	.000	.750	.831	.250	.868	.983	.900	.750	.000	.000	.750	.850	.910	.250	.905

# Accurate Counts

978-664-2565

File Name : 20270B17

Site Code : 20270017

Start Date : 10/2/2024

Page No : 6

N/S Street : Spring St / Sapper St

E/W Street : Plymouth Street

City/State : Bridgewater, MA

Weather : Clear

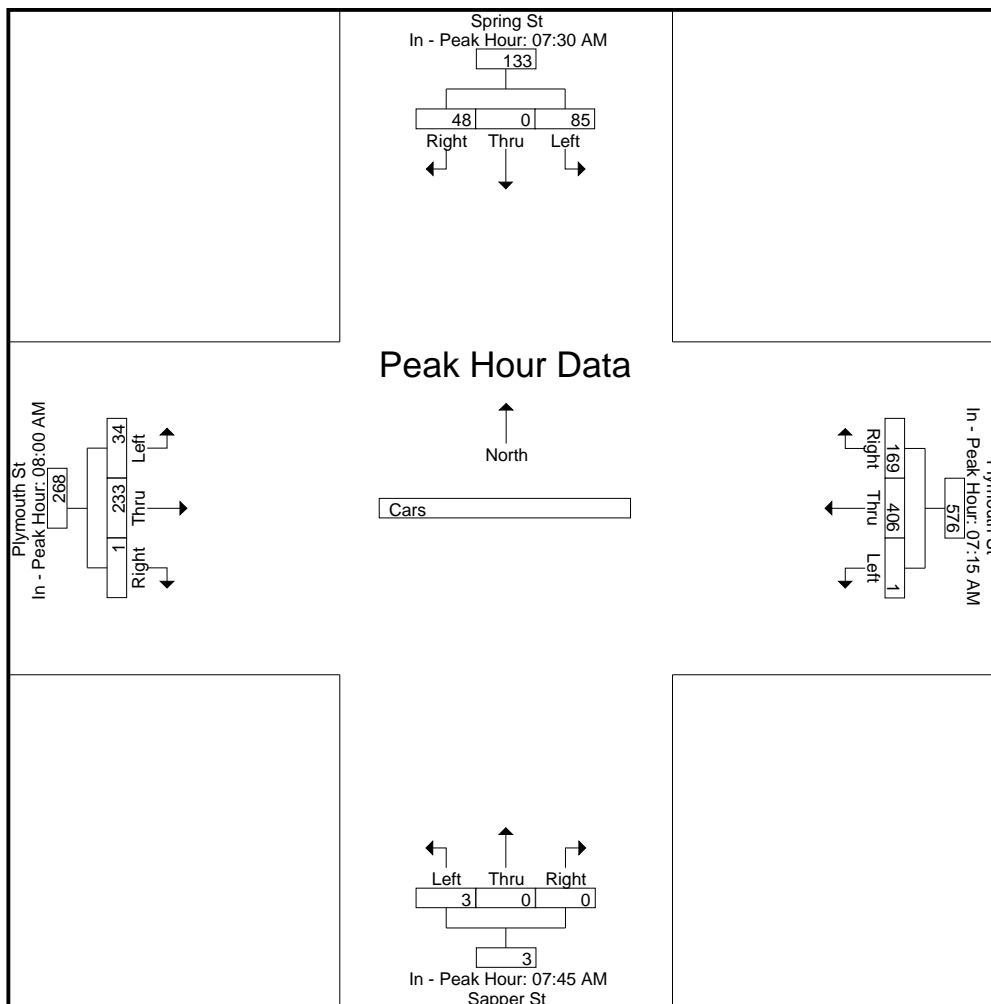

# Accurate Counts

978-664-2565

N/S Street : Spring St / Sapper St

E/W Street : Plymouth Street

City/State : Bridgewater, MA

Weather : Clear

File Name : 20270B17

Site Code : 20270017

Start Date : 10/2/2024

Page No : 7

## Groups Printed- Trucks

Start Time	Spring St From North			Plymouth St From East			Sapper St From South			Plymouth St From West			Int. Total
	Left	Thru	Right	Left	Thru	Right	Left	Thru	Right	Left	Thru	Right	
07:00 AM	0	0	0	0	6	1	0	0	0	0	3	0	10
07:15 AM	0	0	0	0	2	1	0	0	0	0	4	0	7
07:30 AM	0	0	0	0	3	1	0	0	0	0	4	0	8
07:45 AM	0	0	0	0	4	1	0	0	0	0	2	0	7
<b>Total</b>	<b>0</b>	<b>0</b>	<b>0</b>	<b>0</b>	<b>15</b>	<b>4</b>	<b>0</b>	<b>0</b>	<b>0</b>	<b>0</b>	<b>13</b>	<b>0</b>	<b>32</b>
08:00 AM	0	0	2	0	9	1	0	0	0	0	2	0	14
08:15 AM	1	0	1	0	6	2	0	0	0	0	7	0	17
08:30 AM	0	0	0	0	4	2	0	0	0	0	10	0	16
08:45 AM	0	0	0	0	13	1	0	0	0	0	2	0	16
<b>Total</b>	<b>1</b>	<b>0</b>	<b>3</b>	<b>0</b>	<b>32</b>	<b>6</b>	<b>0</b>	<b>0</b>	<b>0</b>	<b>0</b>	<b>21</b>	<b>0</b>	<b>63</b>
<b>Grand Total</b>	<b>1</b>	<b>0</b>	<b>3</b>	<b>0</b>	<b>47</b>	<b>10</b>	<b>0</b>	<b>0</b>	<b>0</b>	<b>0</b>	<b>34</b>	<b>0</b>	<b>95</b>
Apprch %	25	0	75	0	82.5	17.5	0	0	0	0	100	0	
Total %	1.1	0	3.2	0	49.5	10.5	0	0	0	0	35.8	0	

Start Time	Spring St From North				Plymouth St From East				Sapper St From South				Plymouth St From West				Int. Total
	Left	Thru	Right	App. Total	Left	Thru	Right	App. Total	Left	Thru	Right	App. Total	Left	Thru	Right	App. Total	
<b>Peak Hour Analysis From 07:00 AM to 08:45 AM - Peak 1 of 1</b>																	
<b>Peak Hour for Entire Intersection Begins at 08:00 AM</b>																	
08:00 AM	0	0	<b>2</b>	<b>2</b>	0	9	1	10	0	0	0	0	0	2	0	2	14
08:15 AM	<b>1</b>	0	1	2	0	6	<b>2</b>	8	0	0	0	0	0	7	0	7	<b>17</b>
08:30 AM	0	0	0	0	0	4	2	6	0	0	0	0	0	<b>10</b>	0	<b>10</b>	16
08:45 AM	0	0	0	0	0	<b>13</b>	1	<b>14</b>	0	0	0	0	0	2	0	2	16
<b>Total Volume</b>	<b>1</b>	<b>0</b>	<b>3</b>	<b>4</b>	<b>0</b>	<b>32</b>	<b>6</b>	<b>38</b>	<b>0</b>	<b>0</b>	<b>0</b>	<b>0</b>	<b>0</b>	<b>21</b>	<b>0</b>	<b>21</b>	<b>63</b>
<b>% App. Total</b>	<b>25</b>	<b>0</b>	<b>75</b>		<b>0</b>	<b>84.2</b>	<b>15.8</b>		<b>0</b>	<b>0</b>	<b>0</b>		<b>0</b>	<b>100</b>	<b>0</b>		
PHF	.250	.000	.375	.500	.000	.615	.750	.679	.000	.000	.000	.000	.000	.525	.000	.525	.926

# Accurate Counts

978-664-2565

File Name : 20270B17

Site Code : 20270017

Start Date : 10/2/2024

Page No : 8

N/S Street : Spring St / Sapper St

E/W Street : Plymouth Street

City/State : Bridgewater, MA

Weather : Clear

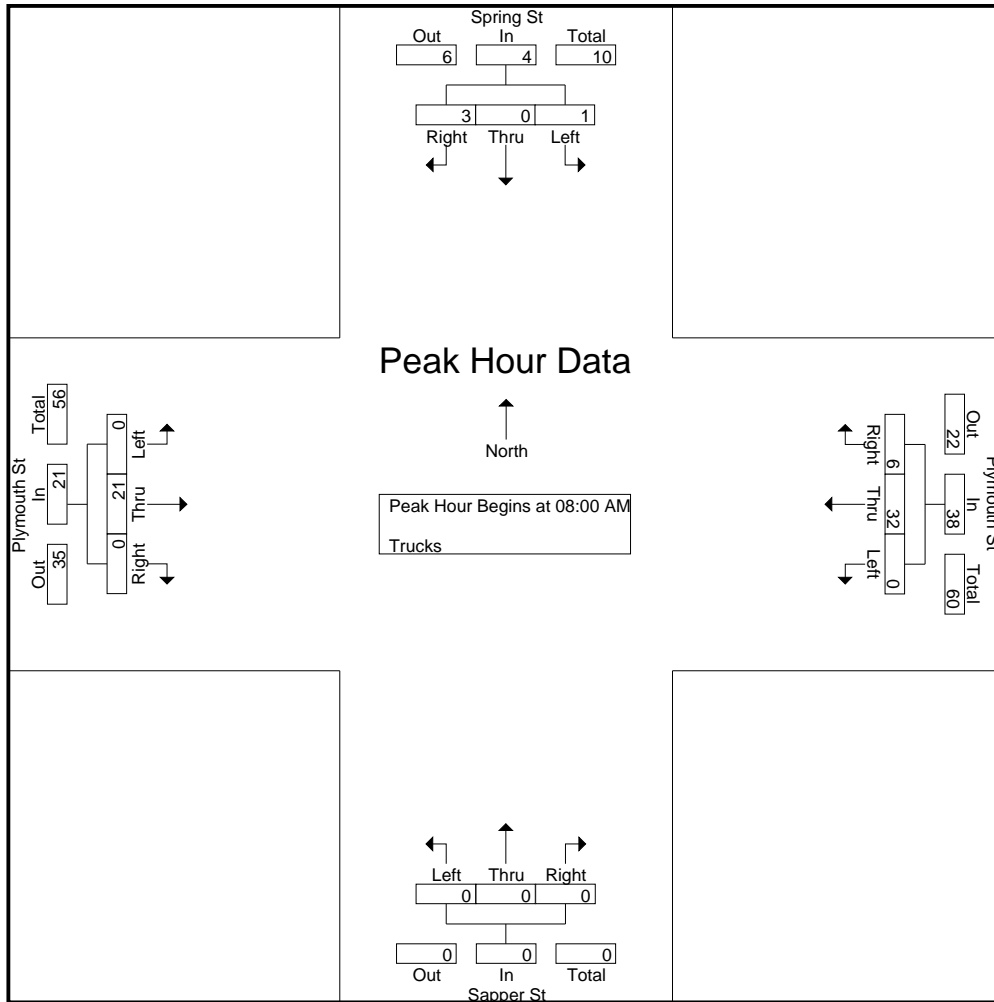

**Peak Hour Analysis From 07:00 AM to 08:45 AM - Peak 1 of 1**

**Peak Hour for Each Approach Begins at:**

	07:30 AM				08:00 AM				07:00 AM				07:45 AM			
+0 mins.	0	0	0	0	0	9	1	10	0	0	0	0	0	2	0	2
+15 mins.	0	0	0	0	0	6	2	8	0	0	0	0	0	2	0	2
+30 mins.	0	0	2	2	0	4	2	6	0	0	0	0	0	7	0	7
+45 mins.	1	0	1	2	0	13	1	14	0	0	0	0	0	10	0	10
Total Volume	1	0	3	4	0	32	6	38	0	0	0	0	0	21	0	21
% App. Total	25	0	75		0	84.2	15.8		0	0	0		0	100	0	
PHF	.250	.000	.375	.500	.000	.615	.750	.679	.000	.000	.000	.000	.000	.525	.000	.525



# Accurate Counts

978-664-2565

N/S Street : Spring St / Sapper St

E/W Street : Plymouth Street

City/State : Bridgewater, MA

Weather : Clear

File Name : 20270B17

Site Code : 20270017

Start Date : 10/2/2024

Page No : 9

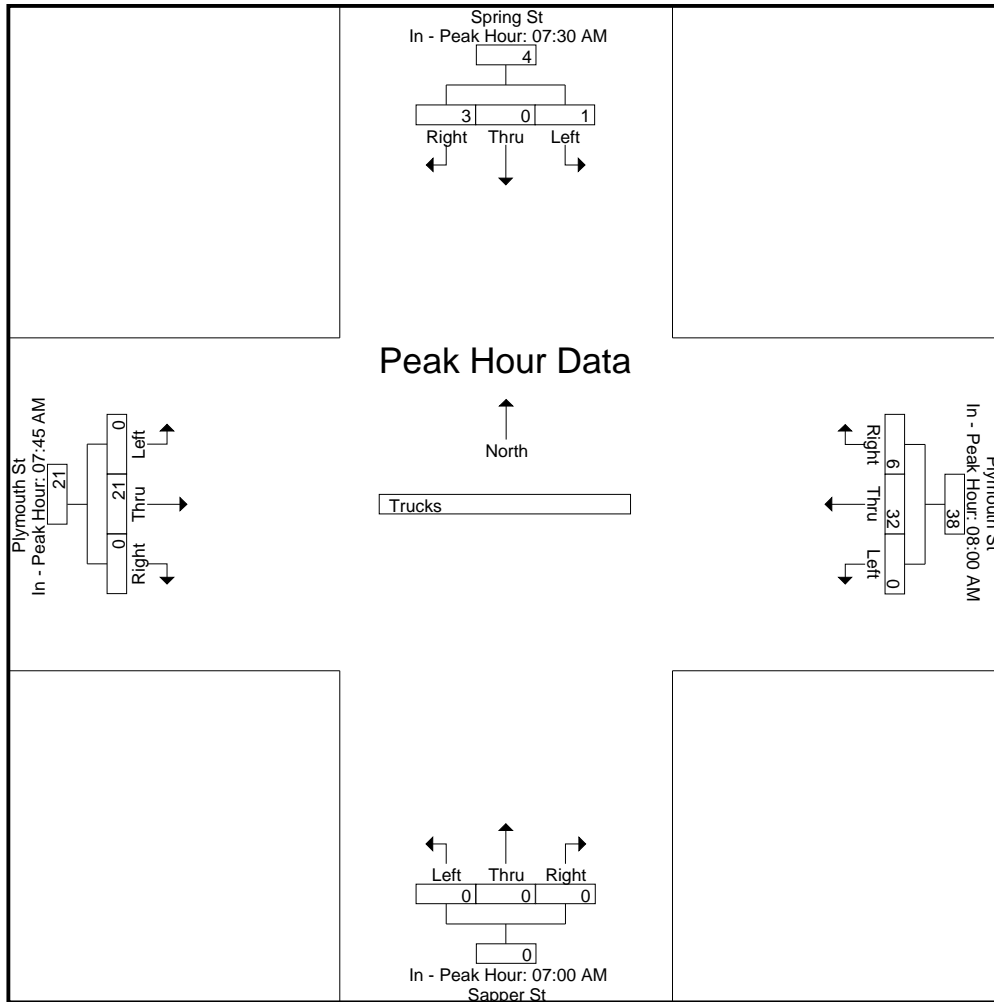

# Accurate Counts

978-664-2565

N/S Street : Spring St / Sapper St

E/W Street : Plymouth Street

City/State : Bridgewater, MA

Weather : Clear

File Name : 20270B17

Site Code : 20270017

Start Date : 10/2/2024

Page No : 10

## Groups Printed- Bikes Peds

Start Time	Spring St From North				Plymouth St From East				Sapper St From South				Plymouth St From West				Exclu. Total	Inclu. Total	Int. Total
	Left	Thru	Right	Peds	Left	Thru	Right	Peds	Left	Thru	Right	Peds	Left	Thru	Right	Peds			
07:00 AM	0	0	0	0	0	0	0	0	0	0	0	0	0	0	0	0	0	0	0
07:15 AM	0	0	0	0	0	0	0	0	0	0	0	0	0	0	0	0	0	0	0
07:30 AM	0	0	0	0	0	0	0	0	0	0	0	1	0	0	0	1	2	0	2
07:45 AM	0	0	0	0	0	0	0	0	0	0	0	1	0	0	0	0	1	0	1
<b>Total</b>	0	0	0	0	0	0	0	0	0	0	0	2	0	0	0	1	3	0	3
08:00 AM	0	0	0	0	0	0	0	0	0	0	0	0	0	0	0	0	0	0	0
08:15 AM	0	0	0	0	0	0	0	0	0	0	0	0	0	0	0	0	0	0	0
08:30 AM	0	0	0	0	0	0	0	0	0	0	0	4	0	1	0	0	4	1	5
08:45 AM	0	0	0	1	0	0	0	0	0	0	0	0	0	0	0	0	1	0	1
<b>Total</b>	0	0	0	1	0	0	0	0	0	0	0	4	0	1	0	0	5	1	6
<b>Grand Total</b>	0	0	0	1	0	0	0	0	0	0	0	6	0	1	0	1	8	1	9
Apprch %	0	0	0		0	0	0		0	0	0		0	100	0				
Total %	0	0	0		0	0	0		0	0	0		0	100	0		88.9	11.1	

Start Time	Spring St From North				Plymouth St From East				Sapper St From South				Plymouth St From West				Int. Total
	Left	Thru	Right	App. Total	Left	Thru	Right	App. Total	Left	Thru	Right	App. Total	Left	Thru	Right	App. Total	
<b>Peak Hour Analysis From 07:00 AM to 08:45 AM - Peak 1 of 1</b>																	
<b>Peak Hour for Entire Intersection Begins at 07:45 AM</b>																	
07:45 AM	0	0	0	0	0	0	0	0	0	0	0	0	0	0	0	0	0
08:00 AM	0	0	0	0	0	0	0	0	0	0	0	0	0	0	0	0	0
08:15 AM	0	0	0	0	0	0	0	0	0	0	0	0	0	0	0	0	0
08:30 AM	0	0	0	0	0	0	0	0	0	0	0	0	0	1	0	1	1
<b>Total Volume</b>	0	0	0	0	0	0	0	0	0	0	0	0	0	1	0	1	1
<b>% App. Total</b>	0	0	0		0	0	0		0	0	0		0	100	0		
<b>PHF</b>	.000	.000	.000	.000	.000	.000	.000	.000	.000	.000	.000	.000	.000	.250	.000	.250	.250

# Accurate Counts

978-664-2565

N/S Street : Spring St / Sapper St  
 E/W Street : Plymouth Street  
 City/State : Bridgewater, MA  
 Weather : Clear

File Name : 20270B17  
 Site Code : 20270017  
 Start Date : 10/2/2024  
 Page No : 11

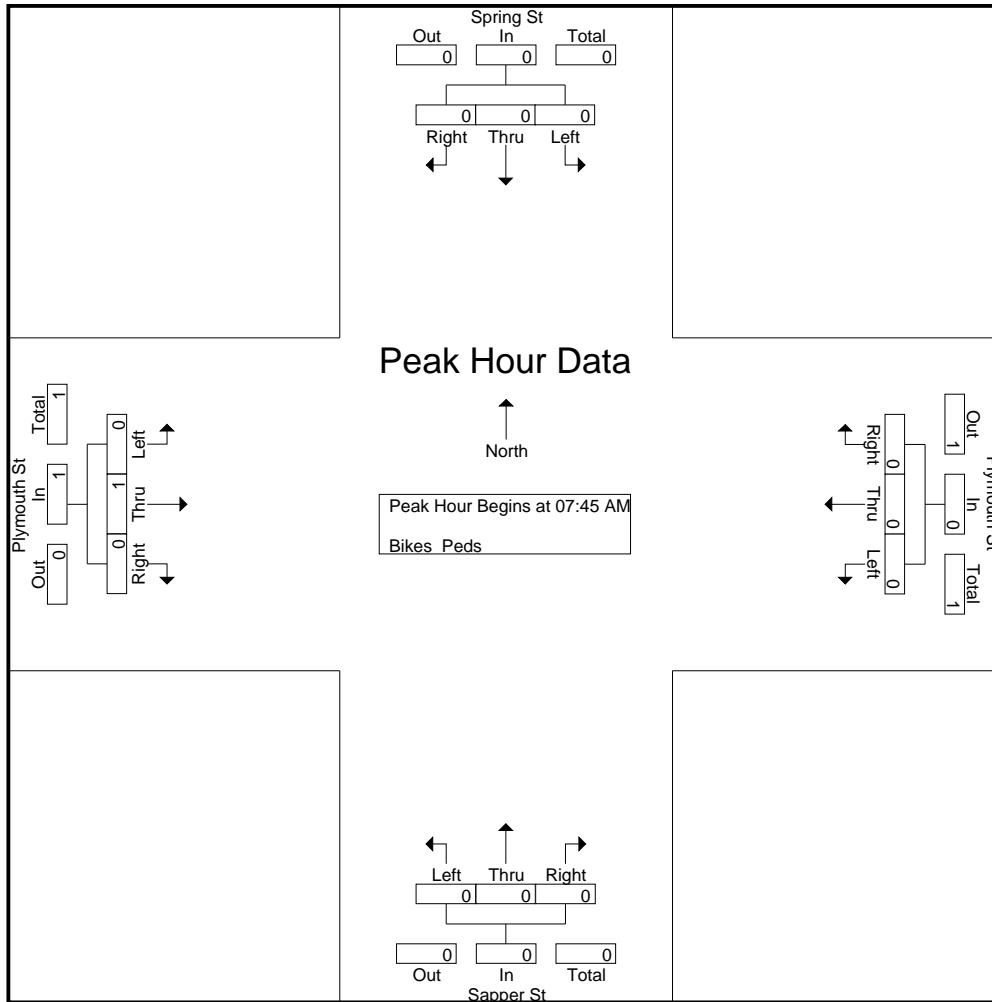

**Peak Hour Analysis From 07:00 AM to 08:45 AM - Peak 1 of 1**

Peak Hour for Each Approach Begins at:

	07:00 AM				07:00 AM				07:00 AM				07:45 AM			
+0 mins.	0	0	0	0	0	0	0	0	0	0	0	0	0	0	0	0
+15 mins.	0	0	0	0	0	0	0	0	0	0	0	0	0	0	0	0
+30 mins.	0	0	0	0	0	0	0	0	0	0	0	0	0	0	0	0
+45 mins.	0	0	0	0	0	0	0	0	0	0	0	0	0	1	0	1
Total Volume	0	0	0	0	0	0	0	0	0	0	0	0	0	1	0	1
% App. Total	0	0	0	0	0	0	0	0	0	0	0	0	0	100	0	0
PHF	.000	.000	.000	.000	.000	.000	.000	.000	.000	.000	.000	.000	.000	.250	.000	.250

# Accurate Counts

978-664-2565

N/S Street : Spring St / Sapper St

E/W Street : Plymouth Street

City/State : Bridgewater, MA

Weather : Clear

File Name : 20270B17

Site Code : 20270017

Start Date : 10/2/2024

Page No : 12

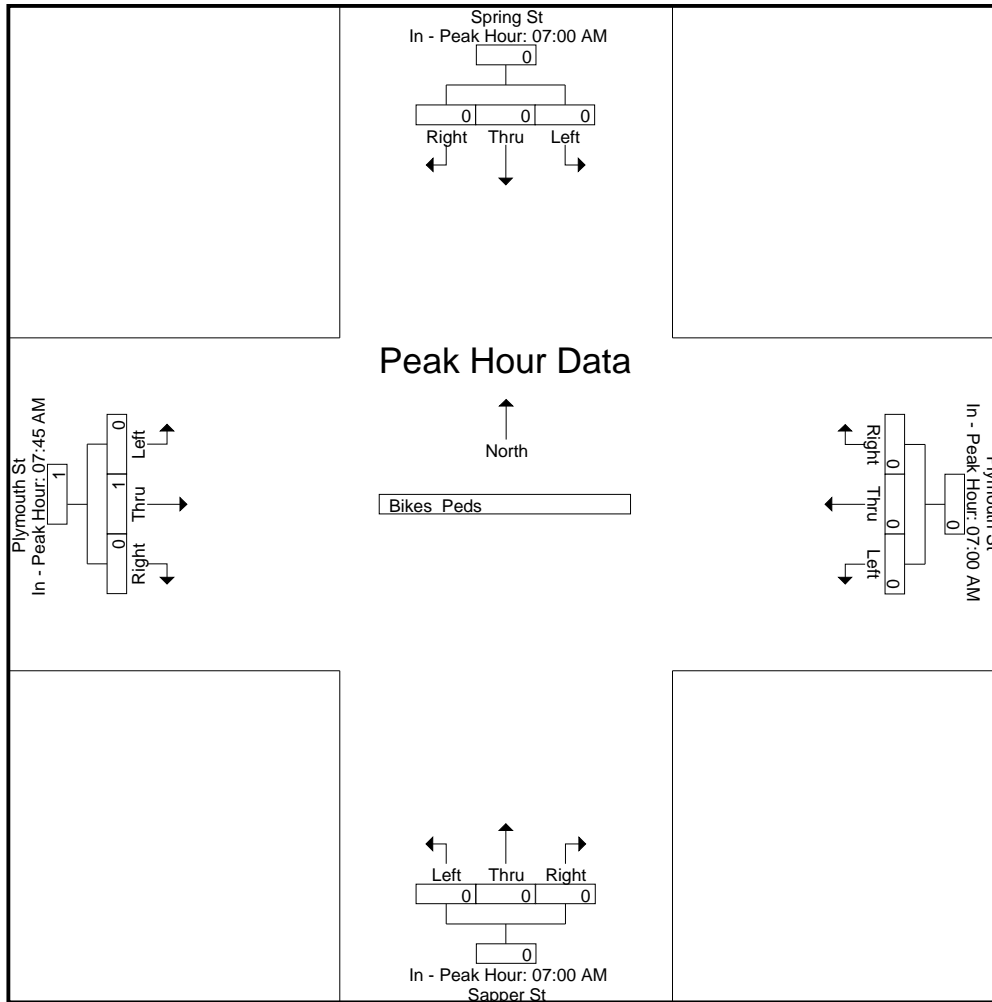

# Accurate Counts

978-664-2565

N/S Street : Spring St / Sapper St

E/W Street : Plymouth Street

City/State : Bridgewater, MA

Weather : Clear

File Name : 20270B17

Site Code : 20270017

Start Date : 10/2/2024

Page No : 1

### Groups Printed- Cars - Trucks

Start Time	Spring St From North			Plymouth St From East			Sapper St From South			Plymouth St From West			Int. Total
	Left	Thru	Right	Left	Thru	Right	Left	Thru	Right	Left	Thru	Right	
04:00 PM	31	0	20	0	112	27	0	0	0	14	110	1	315
04:15 PM	39	0	31	0	109	41	2	0	1	19	90	0	332
04:30 PM	44	0	42	0	119	53	0	0	1	20	103	0	382
04:45 PM	45	0	32	0	93	42	0	0	0	17	103	0	332
<b>Total</b>	<b>159</b>	<b>0</b>	<b>125</b>	<b>0</b>	<b>433</b>	<b>163</b>	<b>2</b>	<b>0</b>	<b>2</b>	<b>70</b>	<b>406</b>	<b>1</b>	<b>1361</b>
05:00 PM	34	0	26	1	133	46	0	0	0	20	107	0	367
05:15 PM	38	0	20	0	137	51	0	0	2	19	111	1	379
05:30 PM	33	1	24	0	119	29	0	0	0	13	99	0	318
05:45 PM	42	0	42	1	130	45	0	0	0	15	97	0	372
<b>Total</b>	<b>147</b>	<b>1</b>	<b>112</b>	<b>2</b>	<b>519</b>	<b>171</b>	<b>0</b>	<b>0</b>	<b>2</b>	<b>67</b>	<b>414</b>	<b>1</b>	<b>1436</b>
<b>Grand Total</b>	<b>306</b>	<b>1</b>	<b>237</b>	<b>2</b>	<b>952</b>	<b>334</b>	<b>2</b>	<b>0</b>	<b>4</b>	<b>137</b>	<b>820</b>	<b>2</b>	<b>2797</b>
Apprch %	56.2	0.2	43.6	0.2	73.9	25.9	33.3	0	66.7	14.3	85.5	0.2	
Total %	10.9	0	8.5	0.1	34	11.9	0.1	0	0.1	4.9	29.3	0.1	
Cars	306	1	237	2	935	324	2	0	4	136	806	2	2755
% Cars	100	100	100	100	98.2	97	100	0	100	99.3	98.3	100	98.5
Trucks	0	0	0	0	17	10	0	0	0	1	14	0	42
% Trucks	0	0	0	0	1.8	3	0	0	0	0.7	1.7	0	1.5

Start Time	Spring St From North				Plymouth St From East				Sapper St From South				Plymouth St From West				Int. Total
	Left	Thru	Right	App. Total	Left	Thru	Right	App. Total	Left	Thru	Right	App. Total	Left	Thru	Right	App. Total	
Peak Hour Analysis From 04:00 PM to 05:45 PM - Peak 1 of 1																	
Peak Hour for Entire Intersection Begins at 04:30 PM																	
04:30 PM	44	0	<b>42</b>	<b>86</b>	0	119	<b>53</b>	172	0	0	1	1	<b>20</b>	103	0	123	<b>382</b>
04:45 PM	<b>45</b>	0	32	77	0	93	42	135	0	0	0	0	17	103	0	120	332
05:00 PM	34	0	26	60	<b>1</b>	133	46	180	0	0	0	0	20	107	0	127	367
05:15 PM	38	0	20	58	0	<b>137</b>	51	<b>188</b>	0	0	<b>2</b>	<b>2</b>	19	<b>111</b>	<b>1</b>	<b>131</b>	379
<b>Total Volume</b>	<b>161</b>	<b>0</b>	<b>120</b>	<b>281</b>	<b>1</b>	<b>482</b>	<b>192</b>	<b>675</b>	<b>0</b>	<b>0</b>	<b>3</b>	<b>3</b>	<b>76</b>	<b>424</b>	<b>1</b>	<b>501</b>	<b>1460</b>
<b>% App. Total</b>	<b>57.3</b>	<b>0</b>	<b>42.7</b>		<b>0.1</b>	<b>71.4</b>	<b>28.4</b>		<b>0</b>	<b>0</b>	<b>100</b>		<b>15.2</b>	<b>84.6</b>	<b>0.2</b>		
PHF	.894	.000	.714	.817	.250	.880	.906	.898	.000	.000	.375	.375	.950	.955	.250	.956	.955
Cars	161	0	120	281	1	472	188	661	0	0	3	3	76	418	1	495	1440
% Cars	100	0	100	100	100	97.9	97.9	97.9	0	0	100	100	100	98.6	100	98.8	98.6
Trucks	0	0	0	0	0	10	4	14	0	0	0	0	0	6	0	6	20
% Trucks	0	0	0	0	0	2.1	2.1	2.1	0	0	0	0	0	1.4	0	1.2	1.4

# Accurate Counts

978-664-2565

N/S Street : Spring St / Sapper St  
 E/W Street : Plymouth Street  
 City/State : Bridgewater, MA  
 Weather : Clear

File Name : 20270B17  
 Site Code : 20270017  
 Start Date : 10/2/2024  
 Page No : 2

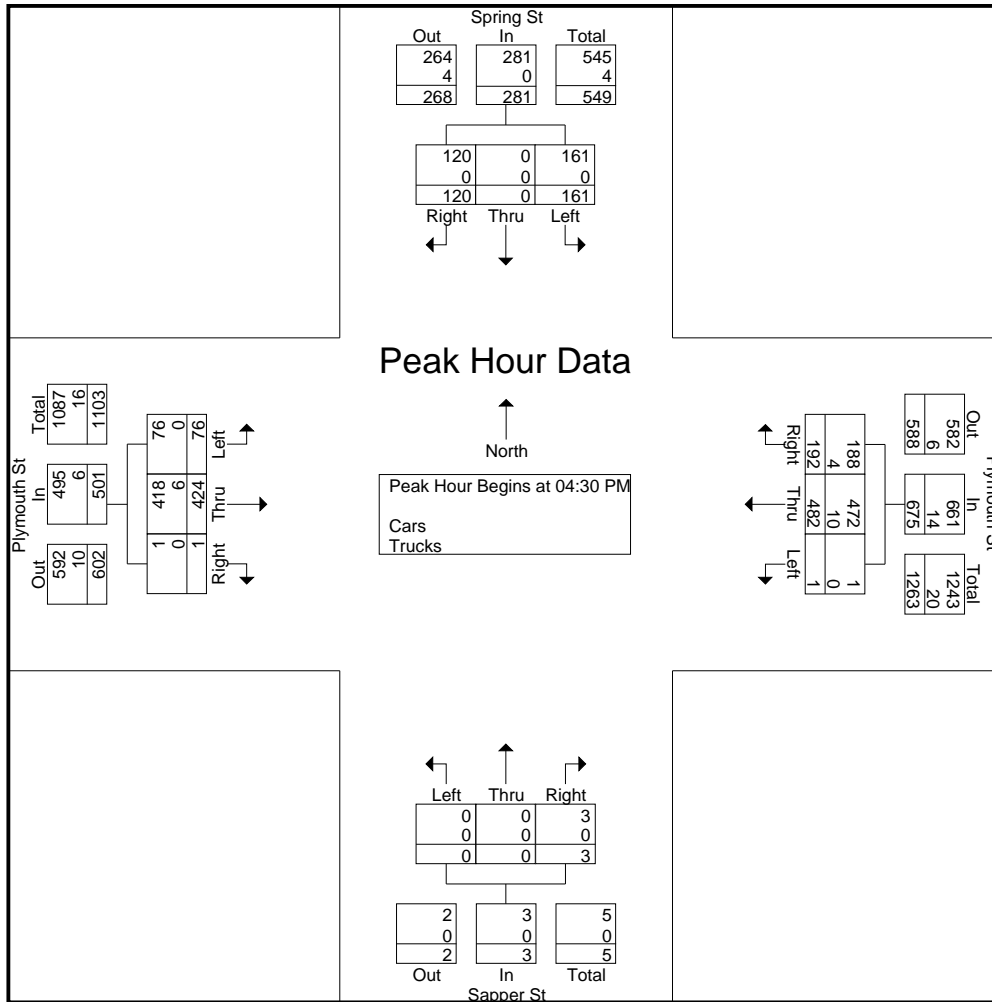

**Peak Hour Analysis From 04:00 PM to 05:45 PM - Peak 1 of 1**

**Peak Hour for Each Approach Begins at:**

	04:15 PM				05:00 PM				04:00 PM				04:30 PM			
+0 mins.	39	0	31	70	<b>1</b>	133	46	180	0	0	0	0	<b>20</b>	103	0	123
+15 mins.	44	0	<b>42</b>	<b>86</b>	0	<b>137</b>	<b>51</b>	<b>188</b>	<b>2</b>	0	<b>1</b>	<b>3</b>	17	103	0	120
+30 mins.	<b>45</b>	0	32	77	0	119	29	148	0	0	1	1	20	107	0	127
+45 mins.	34	0	26	60	1	130	45	176	0	0	0	0	19	<b>111</b>	<b>1</b>	<b>131</b>
Total Volume	162	0	131	293	2	519	171	692	2	0	2	4	76	424	1	501
% App. Total	55.3	0	44.7		0.3	75	24.7		50	0	50		15.2	84.6	0.2	
PHF	.900	.000	.780	.852	.500	.947	.838	.920	.250	.000	.500	.333	.950	.955	.250	.956
Cars	162	0	131	293	2	514	167	683	2	0	2	4	76	418	1	495
% Cars	100	0	100	100	100	99	97.7	98.7	100	0	100	100	100	98.6	100	98.8
Trucks	0	0	0	0	0	5	4	9	0	0	0	0	0	6	0	6
% Trucks	0	0	0	0	0	1	2.3	1.3	0	0	0	0	0	1.4	0	1.2

# Accurate Counts

978-664-2565

File Name : 20270B17

Site Code : 20270017

Start Date : 10/2/2024

Page No : 3

N/S Street : Spring St / Sapper St

E/W Street : Plymouth Street

City/State : Bridgewater, MA

Weather : Clear

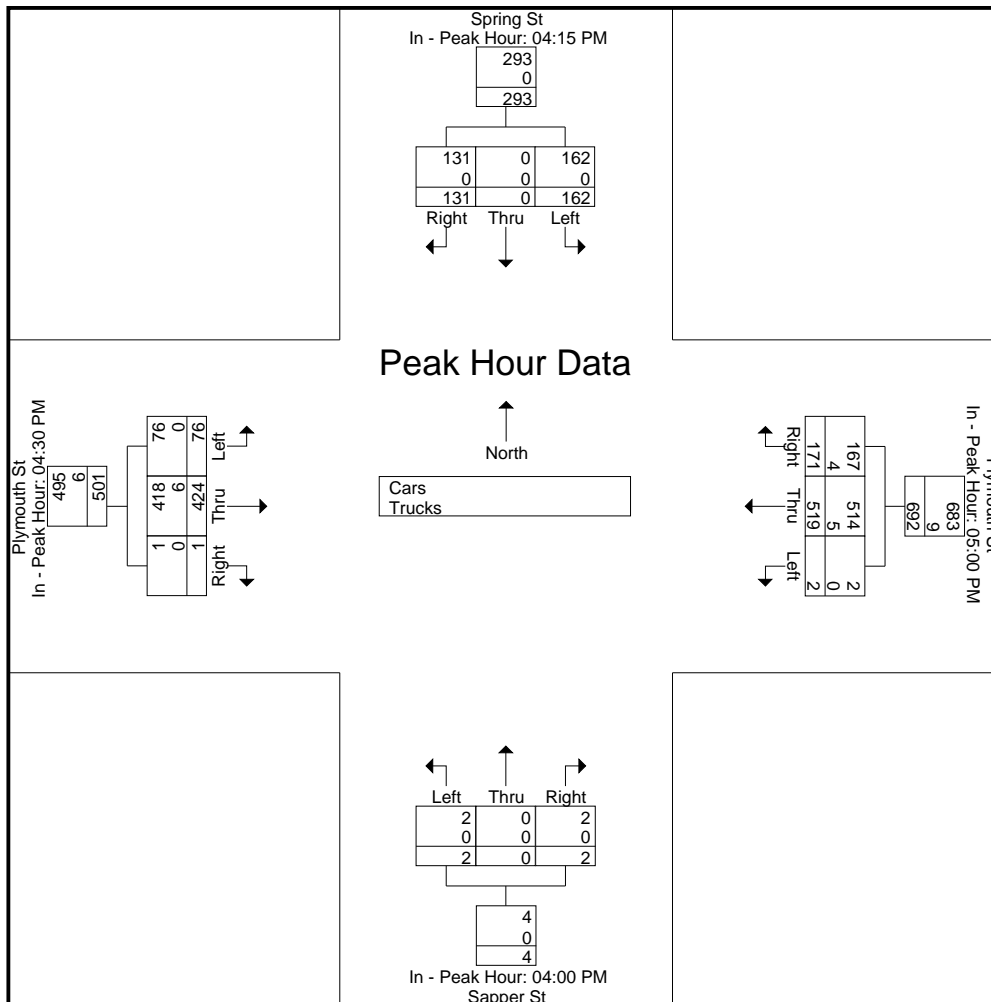

# Accurate Counts

978-664-2565

N/S Street : Spring St / Sapper St  
 E/W Street : Plymouth Street  
 City/State : Bridgewater, MA  
 Weather : Clear

File Name : 20270B17  
 Site Code : 20270017  
 Start Date : 10/2/2024  
 Page No : 4

## Groups Printed- Cars

Start Time	Spring St From North			Plymouth St From East			Sapper St From South			Plymouth St From West			Int. Total
	Left	Thru	Right	Left	Thru	Right	Left	Thru	Right	Left	Thru	Right	
04:00 PM	31	0	20	0	110	26	0	0	0	13	105	1	306
04:15 PM	39	0	31	0	104	38	2	0	1	19	88	0	322
04:30 PM	44	0	42	0	116	51	0	0	1	20	102	0	376
04:45 PM	45	0	32	0	91	42	0	0	0	17	99	0	326
<b>Total</b>	<b>159</b>	<b>0</b>	<b>125</b>	<b>0</b>	<b>421</b>	<b>157</b>	<b>2</b>	<b>0</b>	<b>2</b>	<b>69</b>	<b>394</b>	<b>1</b>	<b>1330</b>
05:00 PM	34	0	26	1	130	45	0	0	0	20	107	0	363
05:15 PM	38	0	20	0	135	50	0	0	2	19	110	1	375
05:30 PM	33	1	24	0	119	28	0	0	0	13	98	0	316
05:45 PM	42	0	42	1	130	44	0	0	0	15	97	0	371
<b>Total</b>	<b>147</b>	<b>1</b>	<b>112</b>	<b>2</b>	<b>514</b>	<b>167</b>	<b>0</b>	<b>0</b>	<b>2</b>	<b>67</b>	<b>412</b>	<b>1</b>	<b>1425</b>
<b>Grand Total</b>	<b>306</b>	<b>1</b>	<b>237</b>	<b>2</b>	<b>935</b>	<b>324</b>	<b>2</b>	<b>0</b>	<b>4</b>	<b>136</b>	<b>806</b>	<b>2</b>	<b>2755</b>
Apprch %	56.2	0.2	43.6	0.2	74.1	25.7	33.3	0	66.7	14.4	85.4	0.2	
Total %	11.1	0	8.6	0.1	33.9	11.8	0.1	0	0.1	4.9	29.3	0.1	

Start Time	Spring St From North				Plymouth St From East				Sapper St From South				Plymouth St From West				Int. Total
	Left	Thru	Right	App. Total	Left	Thru	Right	App. Total	Left	Thru	Right	App. Total	Left	Thru	Right	App. Total	
Peak Hour Analysis From 04:00 PM to 05:45 PM - Peak 1 of 1																	
Peak Hour for Entire Intersection Begins at 04:30 PM																	
04:30 PM	44	0	<b>42</b>	<b>86</b>	0	116	<b>51</b>	167	0	0	1	1	<b>20</b>	102	0	122	<b>376</b>
04:45 PM	<b>45</b>	0	32	77	0	91	42	133	0	0	0	0	17	99	0	116	326
05:00 PM	34	0	26	60	<b>1</b>	130	45	176	0	0	0	0	20	107	0	127	363
05:15 PM	38	0	20	58	0	<b>135</b>	50	<b>185</b>	0	0	<b>2</b>	<b>2</b>	19	<b>110</b>	<b>1</b>	<b>130</b>	375
Total Volume	161	0	120	281	1	472	188	661	0	0	3	3	76	418	1	495	1440
% App. Total	57.3	0	42.7		0.2	71.4	28.4		0	0	100		15.4	84.4	0.2		
PHF	.894	.000	.714	.817	.250	.874	.922	.893	.000	.000	.375	.375	.950	.950	.250	.952	.957



# Accurate Counts

978-664-2565

N/S Street : Spring St / Sapper St  
 E/W Street : Plymouth Street  
 City/State : Bridgewater, MA  
 Weather : Clear

File Name : 20270B17  
 Site Code : 20270017  
 Start Date : 10/2/2024  
 Page No : 5

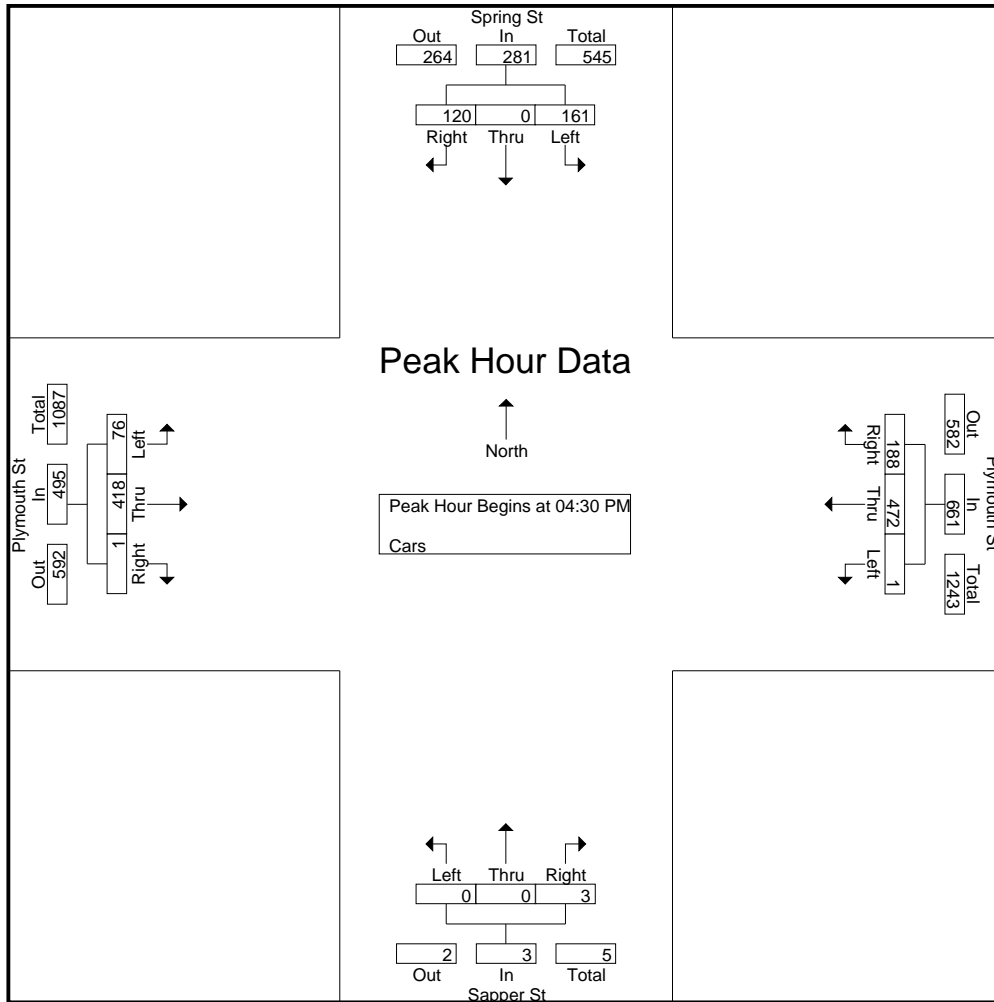

**Peak Hour Analysis From 04:00 PM to 05:45 PM - Peak 1 of 1**

**Peak Hour for Each Approach Begins at:**

	04:15 PM				05:00 PM				04:00 PM				04:30 PM			
+0 mins.	39	0	31	70	<b>1</b>	130	45	176	0	0	0	0	<b>20</b>	102	0	122
+15 mins.	44	0	<b>42</b>	<b>86</b>	0	<b>135</b>	<b>50</b>	<b>185</b>	<b>2</b>	0	<b>1</b>	<b>3</b>	17	99	0	116
+30 mins.	<b>45</b>	0	32	77	0	119	28	147	0	0	1	1	20	107	0	127
+45 mins.	34	0	26	60	1	130	44	175	0	0	0	0	19	<b>110</b>	<b>1</b>	<b>130</b>
<b>Total Volume</b>	162	0	131	293	2	514	167	683	2	0	2	4	76	418	1	495
<b>% App. Total</b>	55.3	0	44.7		0.3	75.3	24.5		50	0	50		15.4	84.4	0.2	
<b>PHF</b>	.900	.000	.780	.852	.500	.952	.835	.923	.250	.000	.500	.333	.950	.950	.250	.952

# Accurate Counts

978-664-2565

File Name : 20270B17

Site Code : 20270017

Start Date : 10/2/2024

Page No : 6

N/S Street : Spring St / Sapper St

E/W Street : Plymouth Street

City/State : Bridgewater, MA

Weather : Clear

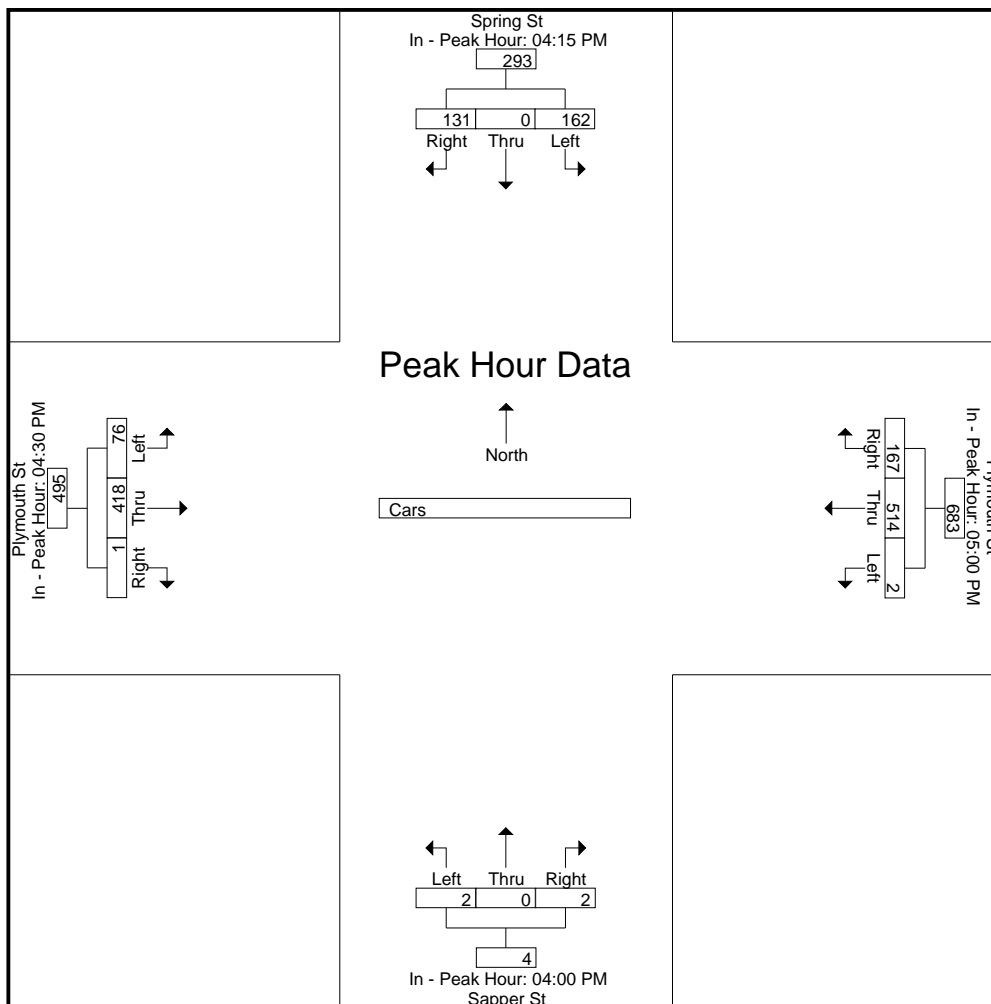

# Accurate Counts

978-664-2565

N/S Street : Spring St / Sapper St  
 E/W Street : Plymouth Street  
 City/State : Bridgewater, MA  
 Weather : Clear

File Name : 20270B17  
 Site Code : 20270017  
 Start Date : 10/2/2024  
 Page No : 7

## Groups Printed- Trucks

Start Time	Spring St From North			Plymouth St From East			Sapper St From South			Plymouth St From West			Int. Total
	Left	Thru	Right	Left	Thru	Right	Left	Thru	Right	Left	Thru	Right	
04:00 PM	0	0	0	0	2	1	0	0	0	1	5	0	9
04:15 PM	0	0	0	0	5	3	0	0	0	0	2	0	10
04:30 PM	0	0	0	0	3	2	0	0	0	0	1	0	6
04:45 PM	0	0	0	0	2	0	0	0	0	0	4	0	6
<b>Total</b>	<b>0</b>	<b>0</b>	<b>0</b>	<b>0</b>	<b>12</b>	<b>6</b>	<b>0</b>	<b>0</b>	<b>0</b>	<b>1</b>	<b>12</b>	<b>0</b>	<b>31</b>
05:00 PM	0	0	0	0	3	1	0	0	0	0	0	0	4
05:15 PM	0	0	0	0	2	1	0	0	0	0	1	0	4
05:30 PM	0	0	0	0	0	1	0	0	0	0	1	0	2
05:45 PM	0	0	0	0	0	1	0	0	0	0	0	0	1
<b>Total</b>	<b>0</b>	<b>0</b>	<b>0</b>	<b>0</b>	<b>5</b>	<b>4</b>	<b>0</b>	<b>0</b>	<b>0</b>	<b>0</b>	<b>2</b>	<b>0</b>	<b>11</b>
<b>Grand Total</b>	<b>0</b>	<b>0</b>	<b>0</b>	<b>0</b>	<b>17</b>	<b>10</b>	<b>0</b>	<b>0</b>	<b>0</b>	<b>1</b>	<b>14</b>	<b>0</b>	<b>42</b>
Apprch %	0	0	0	0	63	37	0	0	0	6.7	93.3	0	
Total %	0	0	0	0	40.5	23.8	0	0	0	2.4	33.3	0	

Start Time	Spring St From North				Plymouth St From East				Sapper St From South				Plymouth St From West				Int. Total
	Left	Thru	Right	App. Total	Left	Thru	Right	App. Total	Left	Thru	Right	App. Total	Left	Thru	Right	App. Total	
<b>Peak Hour Analysis From 04:00 PM to 05:45 PM - Peak 1 of 1</b>																	
<b>Peak Hour for Entire Intersection Begins at 04:00 PM</b>																	
04:00 PM	0	0	0	0	0	2	1	3	0	0	0	0	1	5	0	6	9
04:15 PM	0	0	0	0	0	5	3	8	0	0	0	0	0	2	0	2	10
04:30 PM	0	0	0	0	0	3	2	5	0	0	0	0	0	1	0	1	6
04:45 PM	0	0	0	0	0	2	0	2	0	0	0	0	0	4	0	4	6
<b>Total Volume</b>	<b>0</b>	<b>0</b>	<b>0</b>	<b>0</b>	<b>0</b>	<b>12</b>	<b>6</b>	<b>18</b>	<b>0</b>	<b>0</b>	<b>0</b>	<b>0</b>	<b>1</b>	<b>12</b>	<b>0</b>	<b>13</b>	<b>31</b>
<b>% App. Total</b>	<b>0</b>	<b>0</b>	<b>0</b>	<b>0</b>	<b>0</b>	<b>66.7</b>	<b>33.3</b>		<b>0</b>	<b>0</b>	<b>0</b>	<b>0</b>	<b>7.7</b>	<b>92.3</b>	<b>0</b>		
PHF	.000	.000	.000	.000	.000	.600	.500	.563	.000	.000	.000	.000	.250	.600	.000	.542	.775

# Accurate Counts

978-664-2565

N/S Street : Spring St / Sapper St  
 E/W Street : Plymouth Street  
 City/State : Bridgewater, MA  
 Weather : Clear

File Name : 20270B17  
 Site Code : 20270017  
 Start Date : 10/2/2024  
 Page No : 8

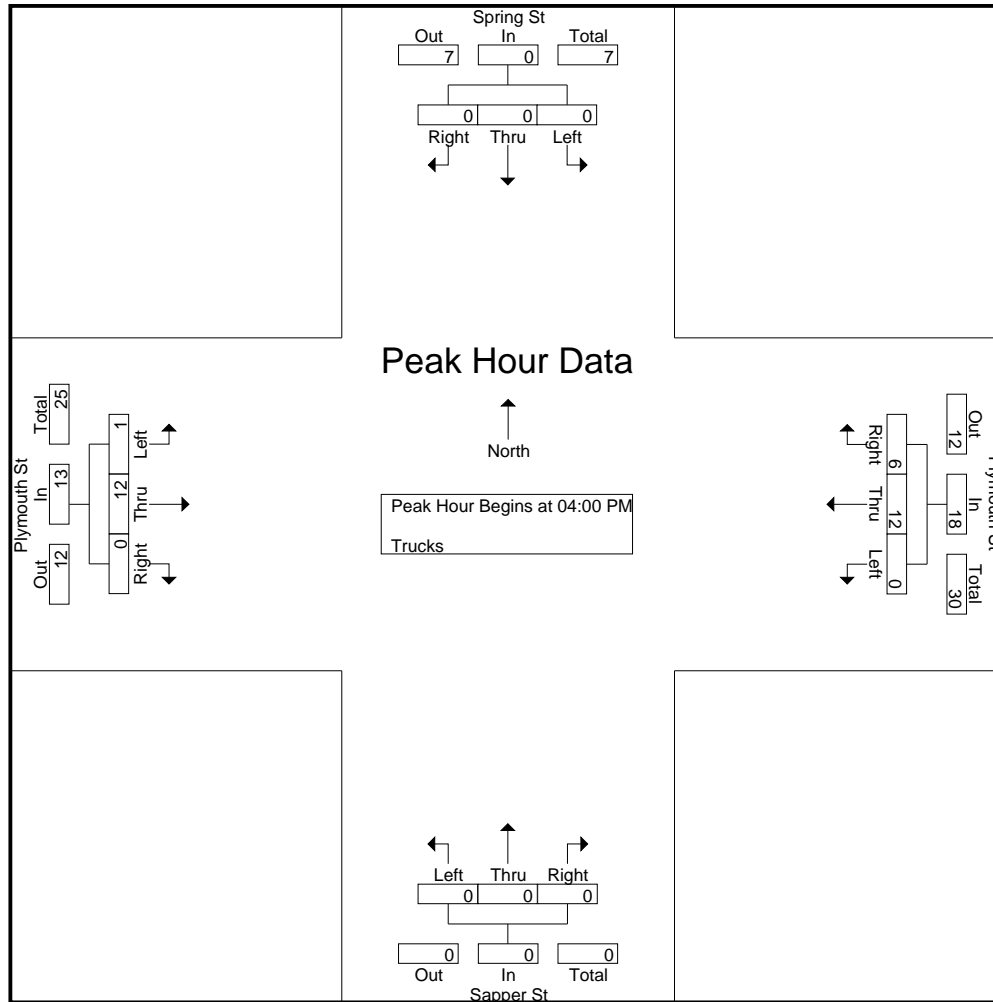

**Peak Hour Analysis From 04:00 PM to 05:45 PM - Peak 1 of 1**

**Peak Hour for Each Approach Begins at:**

	04:00 PM				04:15 PM				04:00 PM				04:00 PM			
+0 mins.	0	0	0	0	0	5	3	8	0	0	0	0	1	5	0	6
+15 mins.	0	0	0	0	0	3	2	5	0	0	0	0	0	2	0	2
+30 mins.	0	0	0	0	0	2	0	2	0	0	0	0	0	1	0	1
+45 mins.	0	0	0	0	0	3	1	4	0	0	0	0	0	4	0	4
Total Volume	0	0	0	0	0	13	6	19	0	0	0	0	1	12	0	13
% App. Total	0	0	0	0	0	68.4	31.6		0	0	0	0	7.7	92.3	0	
PHF	.000	.000	.000	.000	.000	.650	.500	.594	.000	.000	.000	.000	.250	.600	.000	.542

# Accurate Counts

978-664-2565

File Name : 20270B17

Site Code : 20270017

Start Date : 10/2/2024

Page No : 9

N/S Street : Spring St / Sapper St

E/W Street : Plymouth Street

City/State : Bridgewater, MA

Weather : Clear

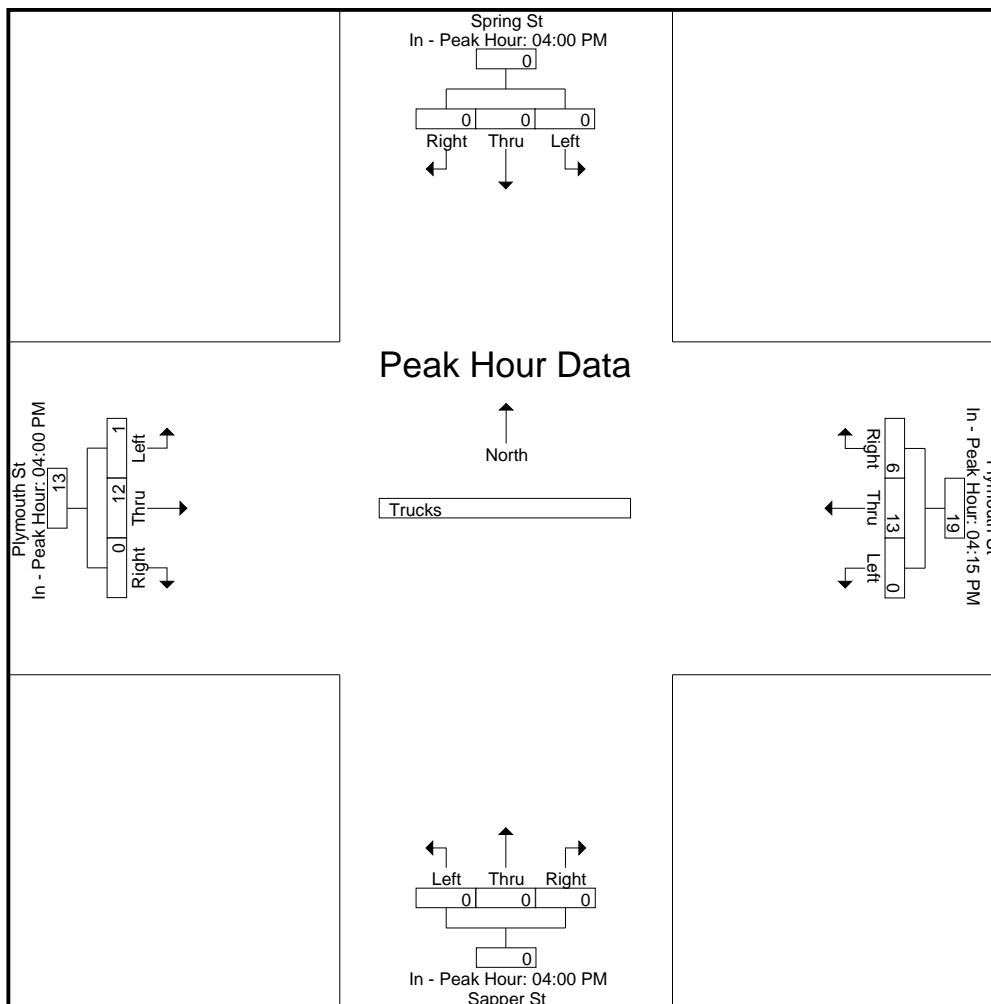

# Accurate Counts

978-664-2565

N/S Street : Spring St / Sapper St

E/W Street : Plymouth Street

City/State : Bridgewater, MA

Weather : Clear

File Name : 20270B17

Site Code : 20270017

Start Date : 10/2/2024

Page No : 10

## Groups Printed- Bikes Peds

Start Time	Spring St From North				Plymouth St From East				Sapper St From South				Plymouth St From West				Exclu. Total	Inclu. Total	Int. Total
	Left	Thru	Right	Peds	Left	Thru	Right	Peds	Left	Thru	Right	Peds	Left	Thru	Right	Peds			
04:00 PM	0	0	0	0	0	0	0	0	0	0	0	0	0	0	0	0	0	0	0
04:15 PM	0	0	0	0	0	0	0	0	0	0	0	4	0	0	0	0	4	0	4
04:30 PM	0	0	0	0	0	0	0	0	0	0	0	1	0	0	0	0	1	0	1
04:45 PM	0	0	0	0	0	1	0	0	0	0	0	0	0	0	0	0	0	1	1
<b>Total</b>	0	0	0	0	0	1	0	0	0	0	0	5	0	0	0	0	5	1	6
05:00 PM	0	0	0	0	0	0	0	0	0	0	0	1	0	0	0	0	1	0	1
05:15 PM	0	0	0	1	0	0	0	0	0	0	0	1	0	0	0	0	2	0	2
05:30 PM	0	0	0	3	0	0	0	0	0	0	0	2	0	0	0	0	5	0	5
05:45 PM	0	0	0	1	0	0	0	0	0	0	0	1	0	0	0	0	2	0	2
<b>Total</b>	0	0	0	5	0	0	0	0	0	0	0	5	0	0	0	0	10	0	10
<b>Grand Total</b>	0	0	0	5	0	1	0	0	0	0	0	10	0	0	0	0	15	1	16
Apprch %	0	0	0		0	100	0		0	0	0		0	0	0				
Total %	0	0	0		0	100	0		0	0	0		0	0	0		93.8	6.2	

Start Time	Spring St From North				Plymouth St From East				Sapper St From South				Plymouth St From West				Int. Total
	Left	Thru	Right	App. Total	Left	Thru	Right	App. Total	Left	Thru	Right	App. Total	Left	Thru	Right	App. Total	
Peak Hour Analysis From 04:00 PM to 05:45 PM - Peak 1 of 1																	
Peak Hour for Entire Intersection Begins at 04:00 PM																	
04:00 PM	0	0	0	0	0	0	0	0	0	0	0	0	0	0	0	0	0
04:15 PM	0	0	0	0	0	0	0	0	0	0	0	0	0	0	0	0	0
04:30 PM	0	0	0	0	0	0	0	0	0	0	0	0	0	0	0	0	0
04:45 PM	0	0	0	0	0	1	0	1	0	0	0	0	0	0	0	0	1
<b>Total Volume</b>	0	0	0	0	0	1	0	1	0	0	0	0	0	0	0	0	1
<b>% App. Total</b>	0	0	0		0	100	0		0	0	0		0	0	0		
PHF	.000	.000	.000	.000	.000	.250	.000	.250	.000	.000	.000	.000	.000	.000	.000	.000	.250

# Accurate Counts

978-664-2565

N/S Street : Spring St / Sapper St  
 E/W Street : Plymouth Street  
 City/State : Bridgewater, MA  
 Weather : Clear

File Name : 20270B17  
 Site Code : 20270017  
 Start Date : 10/2/2024  
 Page No : 11

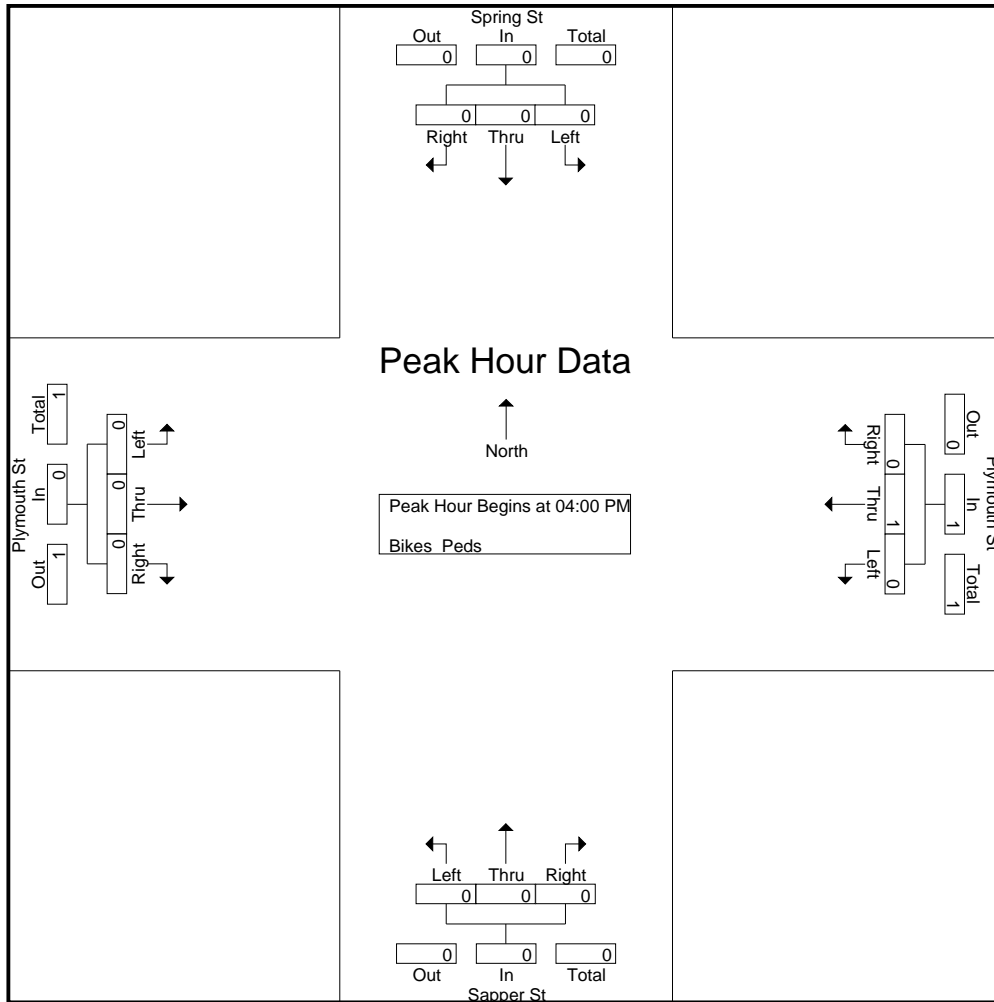

**Peak Hour Analysis From 04:00 PM to 05:45 PM - Peak 1 of 1**

**Peak Hour for Each Approach Begins at:**

	04:00 PM				04:00 PM				04:00 PM				04:00 PM			
+0 mins.	0	0	0	0	0	0	0	0	0	0	0	0	0	0	0	0
+15 mins.	0	0	0	0	0	0	0	0	0	0	0	0	0	0	0	0
+30 mins.	0	0	0	0	0	0	0	0	0	0	0	0	0	0	0	0
+45 mins.	0	0	0	0	0	1	0	1	0	0	0	0	0	0	0	0
Total Volume	0	0	0	0	0	1	0	1	0	0	0	0	0	0	0	0
% App. Total	0	0	0	0	0	100	0	0	0	0	0	0	0	0	0	0
PHF	.000	.000	.000	.000	.000	.250	.000	.250	.000	.000	.000	.000	.000	.000	.000	.000

# Accurate Counts

978-664-2565

File Name : 20270B17

Site Code : 20270017

Start Date : 10/2/2024

Page No : 12

N/S Street : Spring St / Sapper St

E/W Street : Plymouth Street

City/State : Bridgewater, MA

Weather : Clear

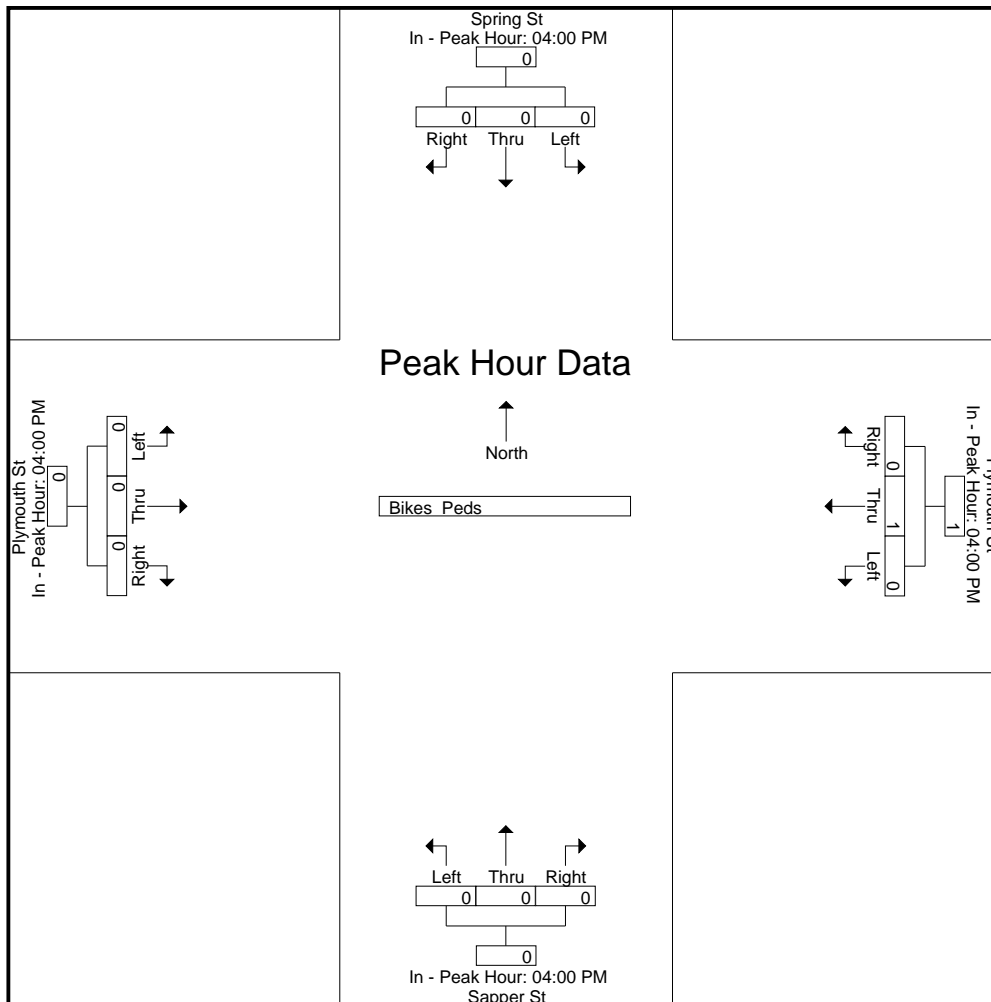



# Accurate Counts

978-664-2565

N/S Street : Morris St / Hooper St

E/W Street : Plymouth Street

City/State : Bridgewater, MA

Weather : Clear

File Name : 20270B18

Site Code : 20270018

Start Date : 10/2/2024

Page No : 1

### Groups Printed- Cars - Trucks

Start Time	Morris St From North			Plymouth St From East			Hooper St From South			Plymouth St From West			Int. Total
	Left	Thru	Right	Left	Thru	Right	Left	Thru	Right	Left	Thru	Right	
07:00 AM	0	0	0	1	130	0	10	1	2	2	50	0	196
07:15 AM	0	0	3	6	118	0	9	0	2	3	63	7	211
07:30 AM	0	0	2	5	140	1	7	0	2	3	61	8	229
07:45 AM	2	0	6	8	139	0	14	0	3	2	64	9	247
<b>Total</b>	<b>2</b>	<b>0</b>	<b>11</b>	<b>20</b>	<b>527</b>	<b>1</b>	<b>40</b>	<b>1</b>	<b>9</b>	<b>10</b>	<b>238</b>	<b>24</b>	<b>883</b>
08:00 AM	0	0	0	2	140	0	10	0	0	1	80	8	241
08:15 AM	0	0	1	6	109	0	14	0	2	2	79	7	220
08:30 AM	1	0	0	13	130	0	13	0	1	2	69	10	239
08:45 AM	2	0	1	8	142	2	24	0	5	3	60	17	264
<b>Total</b>	<b>3</b>	<b>0</b>	<b>2</b>	<b>29</b>	<b>521</b>	<b>2</b>	<b>61</b>	<b>0</b>	<b>8</b>	<b>8</b>	<b>288</b>	<b>42</b>	<b>964</b>
<b>Grand Total</b>	<b>5</b>	<b>0</b>	<b>13</b>	<b>49</b>	<b>1048</b>	<b>3</b>	<b>101</b>	<b>1</b>	<b>17</b>	<b>18</b>	<b>526</b>	<b>66</b>	<b>1847</b>
Apprch %	27.8	0	72.2	4.5	95.3	0.3	84.9	0.8	14.3	3	86.2	10.8	
Total %	0.3	0	0.7	2.7	56.7	0.2	5.5	0.1	0.9	1	28.5	3.6	
Cars	4	0	11	48	1003	2	96	1	13	16	493	65	1752
% Cars	80	0	84.6	98	95.7	66.7	95	100	76.5	88.9	93.7	98.5	94.9
Trucks	1	0	2	1	45	1	5	0	4	2	33	1	95
% Trucks	20	0	15.4	2	4.3	33.3	5	0	23.5	11.1	6.3	1.5	5.1

Start Time	Morris St From North				Plymouth St From East				Hooper St From South				Plymouth St From West				Int. Total
	Left	Thru	Right	App. Total	Left	Thru	Right	App. Total	Left	Thru	Right	App. Total	Left	Thru	Right	App. Total	
Peak Hour Analysis From 07:00 AM to 08:45 AM - Peak 1 of 1																	
Peak Hour for Entire Intersection Begins at 08:00 AM																	
08:00 AM	0	0	0	0	2	140	0	142	10	0	0	10	1	<b>80</b>	8	<b>89</b>	241
08:15 AM	0	0	1	1	6	109	0	115	14	0	2	16	2	79	7	88	220
08:30 AM	1	0	0	1	<b>13</b>	130	0	143	13	0	1	14	2	69	10	81	239
08:45 AM	2	0	1	3	8	<b>142</b>	2	<b>152</b>	<b>24</b>	0	<b>5</b>	<b>29</b>	<b>3</b>	60	<b>17</b>	<b>80</b>	<b>264</b>
<b>Total Volume</b>	<b>3</b>	<b>0</b>	<b>2</b>	<b>5</b>	<b>29</b>	<b>521</b>	<b>2</b>	<b>552</b>	<b>61</b>	<b>0</b>	<b>8</b>	<b>69</b>	<b>8</b>	<b>288</b>	<b>42</b>	<b>338</b>	<b>964</b>
% App. Total	60	0	40		5.3	94.4	0.4		88.4	0	11.6		2.4	85.2	12.4		
PHF	.375	.000	.500	.417	.558	.917	.250	.908	.635	.000	.400	.595	.667	.900	.618	.949	.913
Cars	2	0	2	4	29	493	2	524	56	0	8	64	7	269	42	318	910
% Cars	66.7	0	100	80.0	100	94.6	100	94.9	91.8	0	100	92.8	87.5	93.4	100	94.1	94.4
Trucks	1	0	0	1	0	28	0	28	5	0	0	5	1	19	0	20	54
% Trucks	33.3	0	0	20.0	0	5.4	0	5.1	8.2	0	0	7.2	12.5	6.6	0	5.9	5.6

# Accurate Counts

978-664-2565

N/S Street : Morris St / Hooper St  
 E/W Street : Plymouth Street  
 City/State : Bridgewater, MA  
 Weather : Clear

File Name : 20270B18  
 Site Code : 20270018  
 Start Date : 10/2/2024  
 Page No : 2

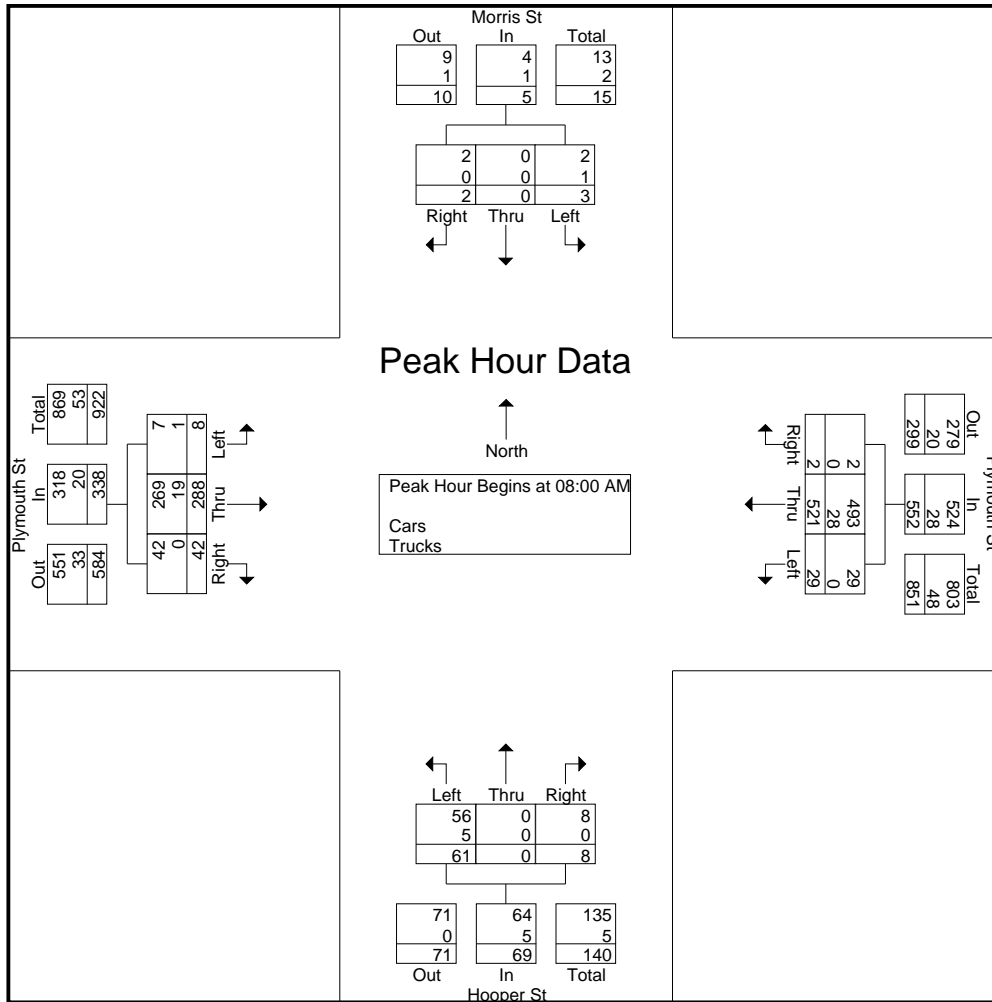

**Peak Hour Analysis From 07:00 AM to 08:45 AM - Peak 1 of 1**

**Peak Hour for Each Approach Begins at:**

	07:00 AM				07:15 AM				08:00 AM				08:00 AM			
+0 mins.	0	0	0	0	6	118	0	124	10	0	0	10	1	<b>80</b>	8	<b>89</b>
+15 mins.	0	0	3	3	5	<b>140</b>	<b>1</b>	146	14	0	2	16	2	79	7	88
+30 mins.	0	0	2	2	<b>8</b>	139	0	<b>147</b>	13	0	1	14	2	69	10	81
+45 mins.	<b>2</b>	0	<b>6</b>	<b>8</b>	2	140	0	142	<b>24</b>	0	<b>5</b>	<b>29</b>	<b>3</b>	60	<b>17</b>	80
Total Volume	2	0	11	13	21	537	1	559	61	0	8	69	8	288	42	338
% App. Total	15.4	0	84.6		3.8	96.1	0.2		88.4	0	11.6		2.4	85.2	12.4	
PHF	.250	.000	.458	.406	.656	.959	.250	.951	.635	.000	.400	.595	.667	.900	.618	.949
Cars	2	0	9	11	20	516	0	536	56	0	8	64	7	269	42	318
% Cars	100	0	81.8	84.6	95.2	96.1	0	95.9	91.8	0	100	92.8	87.5	93.4	100	94.1
Trucks	0	0	2	2	1	21	1	23	5	0	0	5	1	19	0	20
% Trucks	0	0	18.2	15.4	4.8	3.9	100	4.1	8.2	0	0	7.2	12.5	6.6	0	5.9

# Accurate Counts

978-664-2565

File Name : 20270B18

Site Code : 20270018

Start Date : 10/2/2024

Page No : 3

N/S Street : Morris St / Hooper St

E/W Street : Plymouth Street

City/State : Bridgewater, MA

Weather : Clear

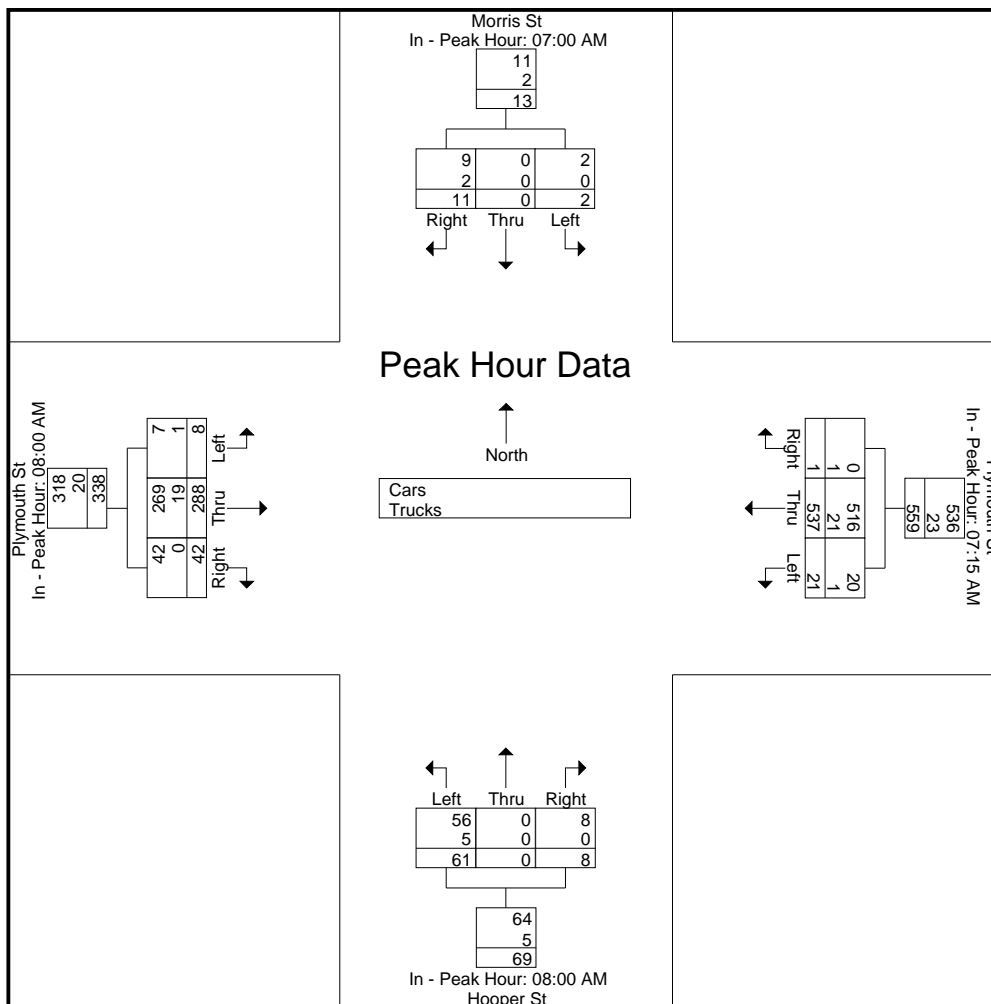

# Accurate Counts

978-664-2565

N/S Street : Morris St / Hooper St  
 E/W Street : Plymouth Street  
 City/State : Bridgewater, MA  
 Weather : Clear

File Name : 20270B18  
 Site Code : 20270018  
 Start Date : 10/2/2024  
 Page No : 4

## Groups Printed- Cars

Start Time	Morris St From North			Plymouth St From East			Hooper St From South			Plymouth St From West			Int. Total
	Left	Thru	Right	Left	Thru	Right	Left	Thru	Right	Left	Thru	Right	
07:00 AM	0	0	0	1	124	0	10	1	1	1	47	0	185
07:15 AM	0	0	2	6	115	0	9	0	1	3	59	7	202
07:30 AM	0	0	2	4	136	0	7	0	1	3	56	7	216
07:45 AM	2	0	5	8	135	0	14	0	2	2	62	9	239
<b>Total</b>	<b>2</b>	<b>0</b>	<b>9</b>	<b>19</b>	<b>510</b>	<b>0</b>	<b>40</b>	<b>1</b>	<b>5</b>	<b>9</b>	<b>224</b>	<b>23</b>	<b>842</b>
08:00 AM	0	0	0	2	130	0	9	0	0	1	78	8	228
08:15 AM	0	0	1	6	106	0	13	0	2	2	73	7	210
08:30 AM	1	0	0	13	123	0	12	0	1	1	60	10	221
08:45 AM	1	0	1	8	134	2	22	0	5	3	58	17	251
<b>Total</b>	<b>2</b>	<b>0</b>	<b>2</b>	<b>29</b>	<b>493</b>	<b>2</b>	<b>56</b>	<b>0</b>	<b>8</b>	<b>7</b>	<b>269</b>	<b>42</b>	<b>910</b>
<b>Grand Total</b>	<b>4</b>	<b>0</b>	<b>11</b>	<b>48</b>	<b>1003</b>	<b>2</b>	<b>96</b>	<b>1</b>	<b>13</b>	<b>16</b>	<b>493</b>	<b>65</b>	<b>1752</b>
Apprch %	26.7	0	73.3	4.6	95.3	0.2	87.3	0.9	11.8	2.8	85.9	11.3	
Total %	0.2	0	0.6	2.7	57.2	0.1	5.5	0.1	0.7	0.9	28.1	3.7	

Start Time	Morris St From North				Plymouth St From East				Hooper St From South				Plymouth St From West				Int. Total
	Left	Thru	Right	App. Total	Left	Thru	Right	App. Total	Left	Thru	Right	App. Total	Left	Thru	Right	App. Total	
<b>Peak Hour Analysis From 07:00 AM to 08:45 AM - Peak 1 of 1</b>																	
<b>Peak Hour for Entire Intersection Begins at 08:00 AM</b>																	
08:00 AM	0	0	0	0	2	130	0	132	9	0	0	9	1	<b>78</b>	8	<b>87</b>	228
08:15 AM	0	0	1	1	6	106	0	112	13	0	2	15	2	73	7	82	210
08:30 AM	1	0	0	1	13	123	0	136	12	0	1	13	1	60	10	71	221
08:45 AM	1	0	1	2	8	<b>134</b>	2	<b>144</b>	22	0	5	27	3	58	17	78	251
<b>Total Volume</b>	<b>2</b>	<b>0</b>	<b>2</b>	<b>4</b>	<b>29</b>	<b>493</b>	<b>2</b>	<b>524</b>	<b>56</b>	<b>0</b>	<b>8</b>	<b>64</b>	<b>7</b>	<b>269</b>	<b>42</b>	<b>318</b>	<b>910</b>
% App. Total	50	0	50		5.5	94.1	0.4		87.5	0	12.5		2.2	84.6	13.2		
PHF	.500	.000	.500	.500	.558	.920	.250	.910	.636	.000	.400	.593	.583	.862	.618	.914	.906

# Accurate Counts

978-664-2565

N/S Street : Morris St / Hooper St  
 E/W Street : Plymouth Street  
 City/State : Bridgewater, MA  
 Weather : Clear

File Name : 20270B18  
 Site Code : 20270018  
 Start Date : 10/2/2024  
 Page No : 5

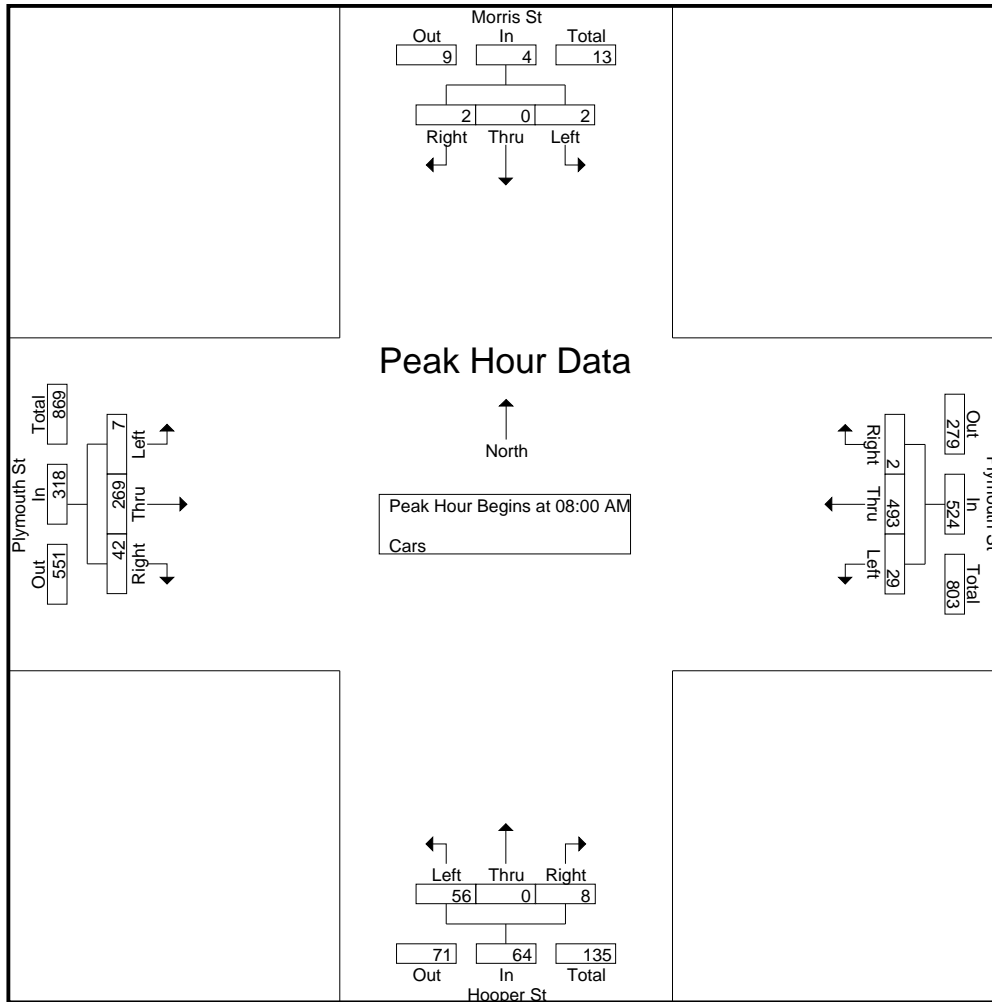

**Peak Hour Analysis From 07:00 AM to 08:45 AM - Peak 1 of 1**

**Peak Hour for Each Approach Begins at:**

	07:00 AM				07:15 AM				08:00 AM				08:00 AM			
+0 mins.	0	0	0	0	6	115	0	121	9	0	0	9	1	<b>78</b>	8	<b>87</b>
+15 mins.	0	0	2	2	4	<b>136</b>	0	140	13	0	2	15	2	73	7	82
+30 mins.	0	0	2	2	<b>8</b>	135	0	<b>143</b>	12	0	1	13	1	60	10	71
+45 mins.	<b>2</b>	0	<b>5</b>	<b>7</b>	2	130	0	132	<b>22</b>	0	<b>5</b>	<b>27</b>	<b>3</b>	58	<b>17</b>	78
Total Volume	2	0	9	11	20	516	0	536	56	0	8	64	7	269	42	318
% App. Total	18.2	0	81.8		3.7	96.3	0		87.5	0	12.5		2.2	84.6	13.2	
PHF	.250	.000	.450	.393	.625	.949	.000	.937	.636	.000	.400	.593	.583	.862	.618	.914

# Accurate Counts

978-664-2565

File Name : 20270B18

Site Code : 20270018

Start Date : 10/2/2024

Page No : 6

N/S Street : Morris St / Hooper St

E/W Street : Plymouth Street

City/State : Bridgewater, MA

Weather : Clear

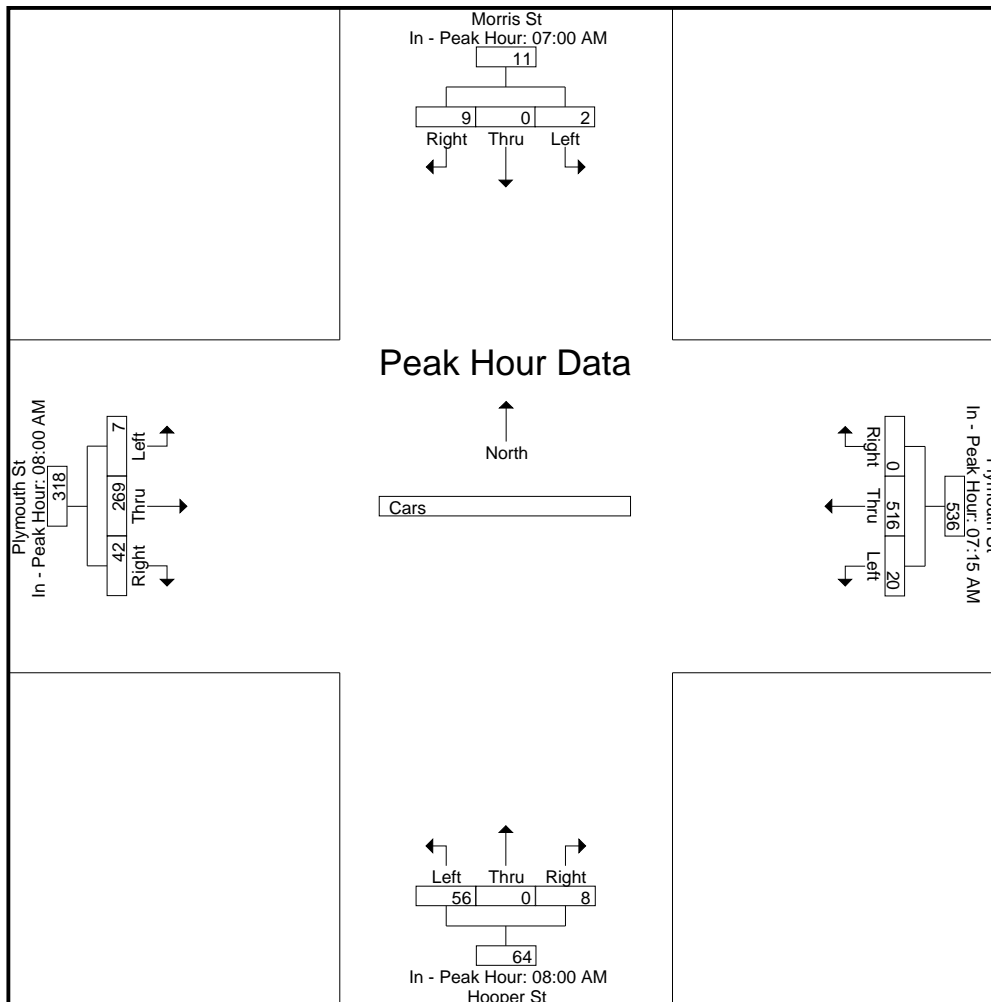

# Accurate Counts

978-664-2565

N/S Street : Morris St / Hooper St  
 E/W Street : Plymouth Street  
 City/State : Bridgewater, MA  
 Weather : Clear

File Name : 20270B18  
 Site Code : 20270018  
 Start Date : 10/2/2024  
 Page No : 7

### Groups Printed- Trucks

Start Time	Morris St From North			Plymouth St From East			Hooper St From South			Plymouth St From West			Int. Total
	Left	Thru	Right	Left	Thru	Right	Left	Thru	Right	Left	Thru	Right	
07:00 AM	0	0	0	0	6	0	0	0	1	1	3	0	11
07:15 AM	0	0	1	0	3	0	0	0	1	0	4	0	9
07:30 AM	0	0	0	1	4	1	0	0	1	0	5	1	13
07:45 AM	0	0	1	0	4	0	0	0	1	0	2	0	8
<b>Total</b>	<b>0</b>	<b>0</b>	<b>2</b>	<b>1</b>	<b>17</b>	<b>1</b>	<b>0</b>	<b>0</b>	<b>4</b>	<b>1</b>	<b>14</b>	<b>1</b>	<b>41</b>
08:00 AM	0	0	0	0	10	0	1	0	0	0	2	0	13
08:15 AM	0	0	0	0	3	0	1	0	0	0	6	0	10
08:30 AM	0	0	0	0	7	0	1	0	0	1	9	0	18
08:45 AM	1	0	0	0	8	0	2	0	0	0	2	0	13
<b>Total</b>	<b>1</b>	<b>0</b>	<b>0</b>	<b>0</b>	<b>28</b>	<b>0</b>	<b>5</b>	<b>0</b>	<b>0</b>	<b>1</b>	<b>19</b>	<b>0</b>	<b>54</b>
<b>Grand Total</b>	<b>1</b>	<b>0</b>	<b>2</b>	<b>1</b>	<b>45</b>	<b>1</b>	<b>5</b>	<b>0</b>	<b>4</b>	<b>2</b>	<b>33</b>	<b>1</b>	<b>95</b>
Apprch %	33.3	0	66.7	2.1	95.7	2.1	55.6	0	44.4	5.6	91.7	2.8	
Total %	1.1	0	2.1	1.1	47.4	1.1	5.3	0	4.2	2.1	34.7	1.1	

Start Time	Morris St From North				Plymouth St From East				Hooper St From South				Plymouth St From West				Int. Total
	Left	Thru	Right	App. Total	Left	Thru	Right	App. Total	Left	Thru	Right	App. Total	Left	Thru	Right	App. Total	
<b>Peak Hour Analysis From 07:00 AM to 08:45 AM - Peak 1 of 1</b>																	
<b>Peak Hour for Entire Intersection Begins at 08:00 AM</b>																	
08:00 AM	0	0	0	0	0	<b>10</b>	0	<b>10</b>	1	0	0	1	0	2	0	2	13
08:15 AM	0	0	0	0	0	3	0	3	1	0	0	1	0	6	0	6	10
08:30 AM	0	0	0	0	0	7	0	7	1	0	0	1	<b>1</b>	<b>9</b>	0	<b>10</b>	<b>18</b>
08:45 AM	<b>1</b>	0	0	<b>1</b>	0	8	0	8	<b>2</b>	0	0	<b>2</b>	0	2	0	2	13
<b>Total Volume</b>	<b>1</b>	<b>0</b>	<b>0</b>	<b>1</b>	<b>0</b>	<b>28</b>	<b>0</b>	<b>28</b>	<b>5</b>	<b>0</b>	<b>0</b>	<b>5</b>	<b>1</b>	<b>19</b>	<b>0</b>	<b>20</b>	<b>54</b>
<b>% App. Total</b>	<b>100</b>	<b>0</b>	<b>0</b>	<b>100</b>	<b>0</b>	<b>100</b>	<b>0</b>	<b>100</b>	<b>100</b>	<b>0</b>	<b>0</b>	<b>100</b>	<b>5</b>	<b>95</b>	<b>0</b>	<b>20</b>	<b>54</b>
PHF	.250	.000	.000	.250	.000	.700	.000	.700	.625	.000	.000	.625	.250	.528	.000	.500	.750

# Accurate Counts

978-664-2565

N/S Street : Morris St / Hooper St  
 E/W Street : Plymouth Street  
 City/State : Bridgewater, MA  
 Weather : Clear

File Name : 20270B18  
 Site Code : 20270018  
 Start Date : 10/2/2024  
 Page No : 8

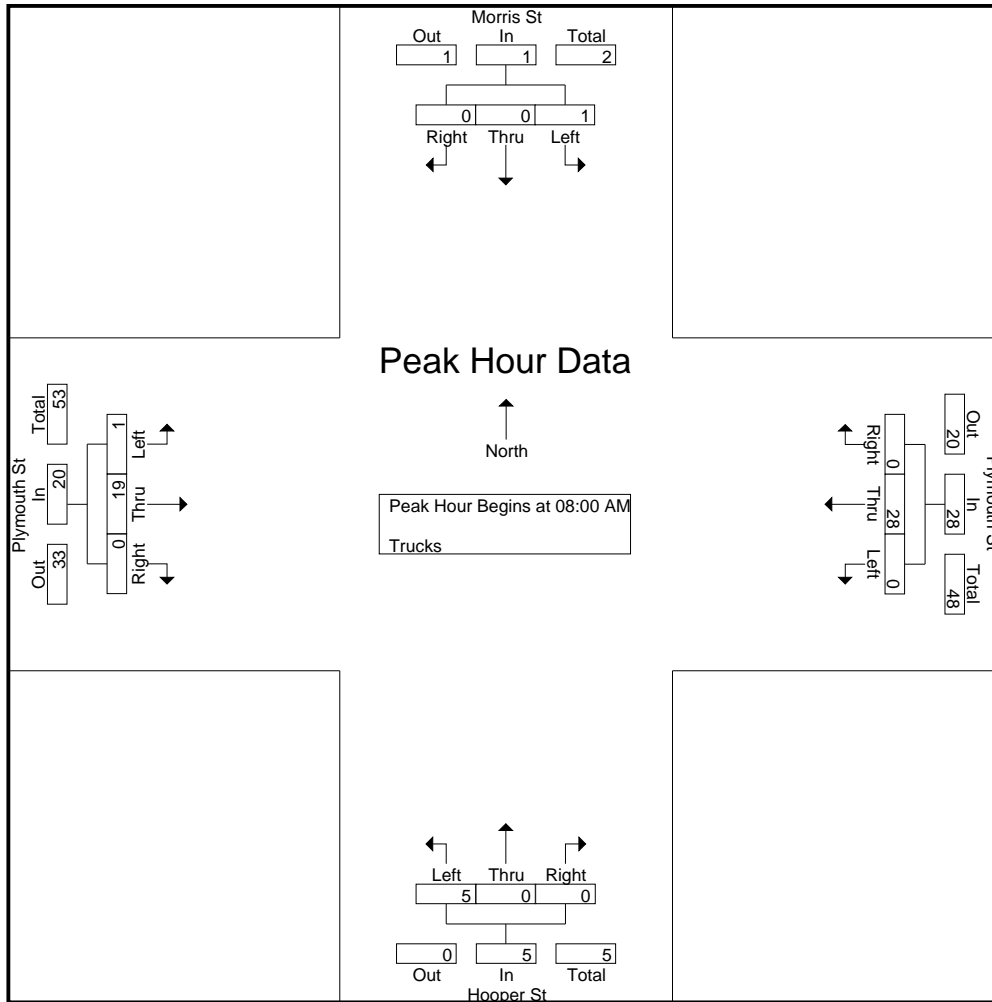

**Peak Hour Analysis From 07:00 AM to 08:45 AM - Peak 1 of 1**

**Peak Hour for Each Approach Begins at:**

	07:00 AM				08:00 AM				08:00 AM				07:45 AM			
+0 mins.	0	0	0	0	0	<b>10</b>	0	<b>10</b>	1	0	0	1	0	2	0	2
+15 mins.	0	0	<b>1</b>	<b>1</b>	0	3	0	3	1	0	0	1	0	2	0	2
+30 mins.	0	0	0	0	0	7	0	7	1	0	0	1	0	6	0	6
+45 mins.	0	0	1	1	0	8	0	8	<b>2</b>	0	0	<b>2</b>	<b>1</b>	<b>9</b>	0	<b>10</b>
Total Volume	0	0	2	2	0	28	0	28	5	0	0	5	1	19	0	20
% App. Total	0	0	100	100	0	100	0	100	100	0	0	100	5	95	0	100
PHF	.000	.000	.500	.500	.000	.700	.000	.700	.625	.000	.000	.625	.250	.528	.000	.500



# Accurate Counts

978-664-2565

File Name : 20270B18

Site Code : 20270018

Start Date : 10/2/2024

Page No : 9

N/S Street : Morris St / Hooper St

E/W Street : Plymouth Street

City/State : Bridgewater, MA

Weather : Clear

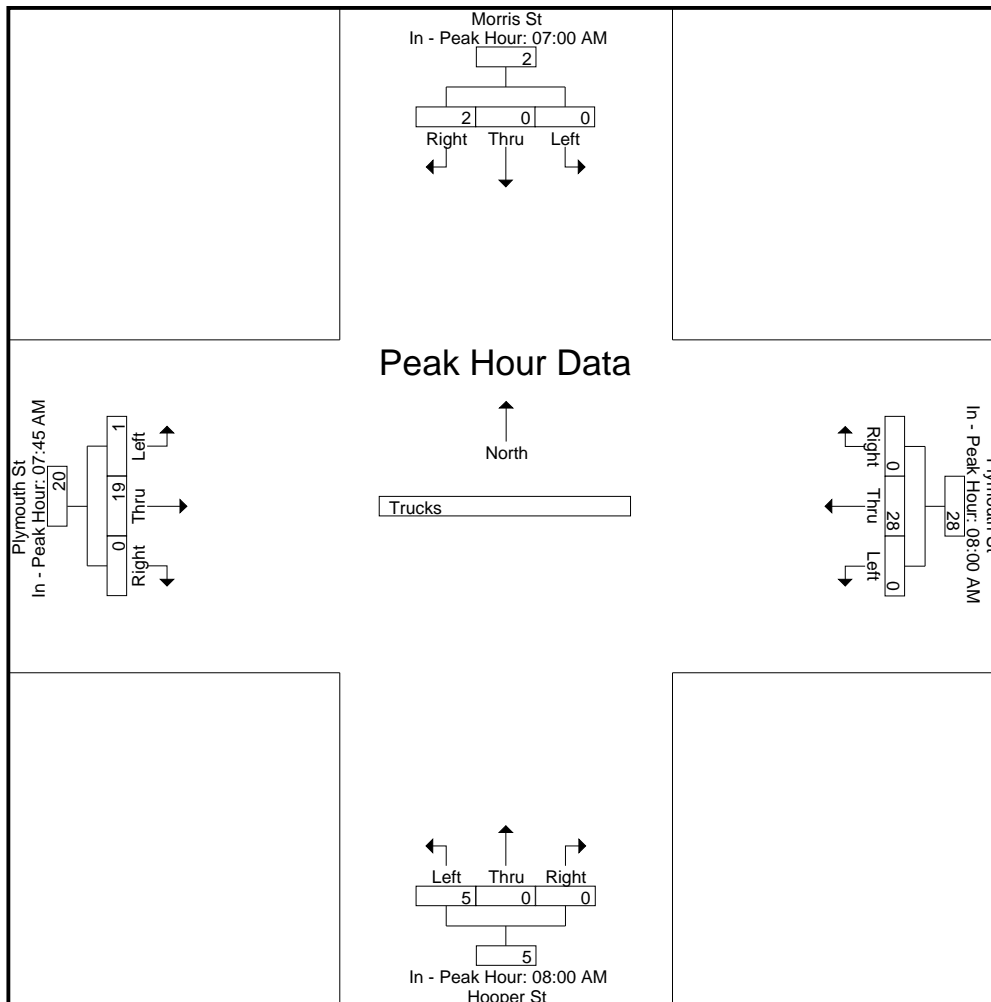

# Accurate Counts

978-664-2565

N/S Street : Morris St / Hooper St  
 E/W Street : Plymouth Street  
 City/State : Bridgewater, MA  
 Weather : Clear

File Name : 20270B18  
 Site Code : 20270018  
 Start Date : 10/2/2024  
 Page No : 10

### Groups Printed- Bikes Peds

Start Time	Morris St From North				Plymouth St From East				Hooper St From South				Plymouth St From West				Exclu. Total	Inclu. Total	Int. Total
	Left	Thru	Right	Peds	Left	Thru	Right	Peds	Left	Thru	Right	Peds	Left	Thru	Right	Peds			
07:00 AM	0	0	0	0	0	0	0	0	0	0	0	0	0	1	0	0	0	0	1
07:15 AM	0	0	0	0	0	0	0	0	0	0	0	0	0	0	0	0	0	0	0
07:30 AM	0	0	0	0	0	0	0	0	0	0	0	1	0	0	0	2	3	0	3
07:45 AM	0	0	0	0	1	0	0	0	0	0	0	0	0	0	0	0	0	1	1
<b>Total</b>	0	0	0	0	1	0	0	0	0	0	0	1	0	1	0	2	3	2	5
08:00 AM	0	0	0	0	1	0	0	0	0	0	0	0	0	0	0	0	0	1	1
08:15 AM	0	0	0	1	0	0	0	0	0	0	0	1	0	0	0	0	2	0	2
08:30 AM	0	0	0	5	0	0	0	0	0	0	0	0	0	1	0	0	5	1	6
08:45 AM	0	0	0	5	0	0	0	2	0	0	0	0	0	0	0	0	7	0	7
<b>Total</b>	0	0	0	11	1	0	0	2	0	0	0	1	0	1	0	0	14	2	16
<b>Grand Total</b>	0	0	0	11	2	0	0	2	0	0	0	2	0	2	0	2	17	4	21
Apprch %	0	0	0		100	0	0		0	0	0		0	100	0				
Total %	0	0	0		50	0	0		0	0	0		0	50	0		81	19	

Start Time	Morris St From North				Plymouth St From East				Hooper St From South				Plymouth St From West				Int. Total	
	Left	Thru	Right	App. Total	Left	Thru	Right	App. Total	Left	Thru	Right	App. Total	Left	Thru	Right	App. Total		
Peak Hour Analysis From 07:00 AM to 08:45 AM - Peak 1 of 1																		
Peak Hour for Entire Intersection Begins at 07:45 AM																		
07:45 AM	0	0	0	0	1	0	0	1	0	0	0	0	0	0	0	0	0	1
08:00 AM	0	0	0	0	1	0	0	1	0	0	0	0	0	0	0	0	0	1
08:15 AM	0	0	0	0	0	0	0	0	0	0	0	0	0	0	0	0	0	0
08:30 AM	0	0	0	0	0	0	0	0	0	0	0	0	0	1	0	1	0	1
Total Volume	0	0	0	0	2	0	0	2	0	0	0	0	0	1	0	1	0	3
% App. Total	0	0	0		100	0	0		0	0	0		0	100	0			
PHF	.000	.000	.000	.000	.500	.000	.000	.500	.000	.000	.000	.000	.000	.250	.000	.250		.750

# Accurate Counts

978-664-2565

N/S Street : Morris St / Hooper St  
 E/W Street : Plymouth Street  
 City/State : Bridgewater, MA  
 Weather : Clear

File Name : 20270B18  
 Site Code : 20270018  
 Start Date : 10/2/2024  
 Page No : 11

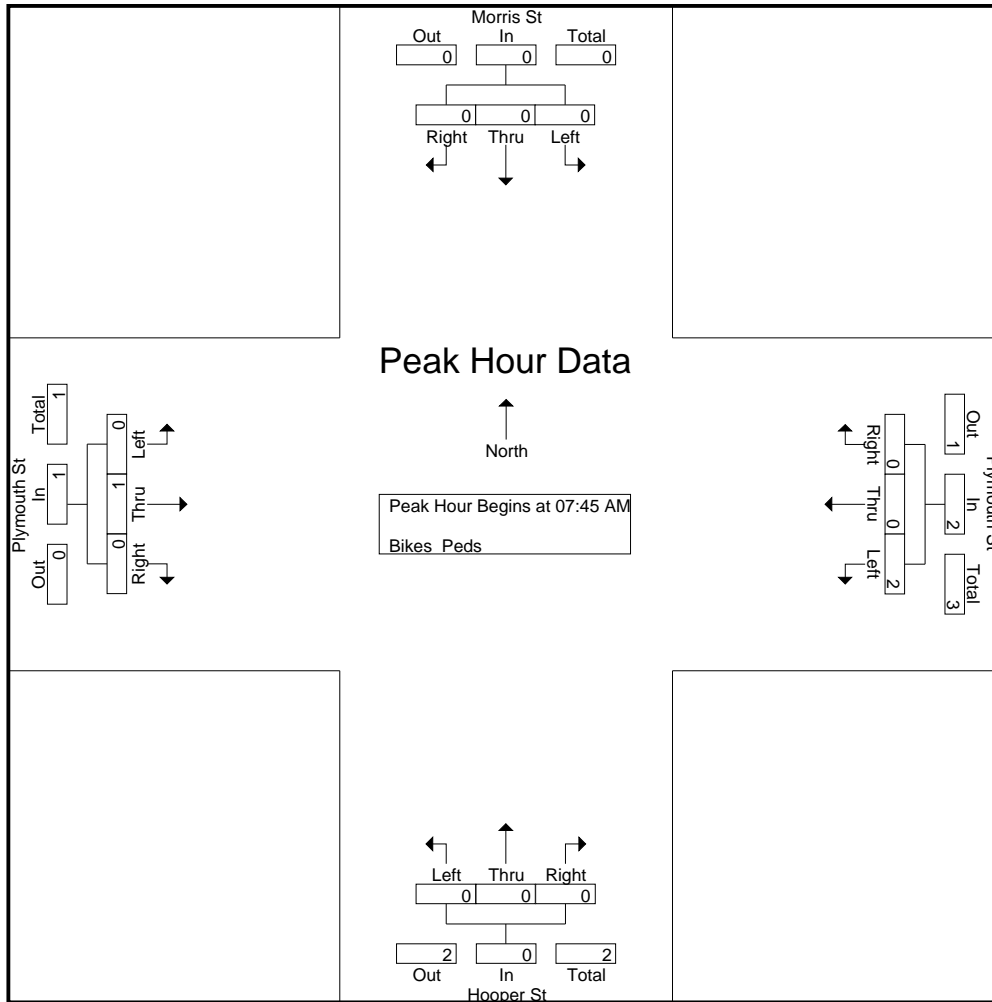

**Peak Hour Analysis From 07:00 AM to 08:45 AM - Peak 1 of 1**

**Peak Hour for Each Approach Begins at:**

	07:00 AM				07:15 AM				07:30 AM				07:45 AM			
+0 mins.	0	0	0	0	0	0	0	0	0	0	0	0	0	1	0	1
+15 mins.	0	0	0	0	0	0	0	0	0	0	0	0	0	0	0	0
+30 mins.	0	0	0	0	1	0	0	1	0	0	0	0	0	0	0	0
+45 mins.	0	0	0	0	1	0	0	1	0	0	0	0	0	0	0	0
Total Volume	0	0	0	0	2	0	0	2	0	0	0	0	0	1	0	1
% App. Total	0	0	0	0	100	0	0	100	0	0	0	0	0	100	0	100
PHF	.000	.000	.000	.000	.500	.000	.000	.500	.000	.000	.000	.000	.000	.250	.000	.250

# Accurate Counts

978-664-2565

File Name : 20270B18

Site Code : 20270018

Start Date : 10/2/2024

Page No : 12

N/S Street : Morris St / Hooper St

E/W Street : Plymouth Street

City/State : Bridgewater, MA

Weather : Clear

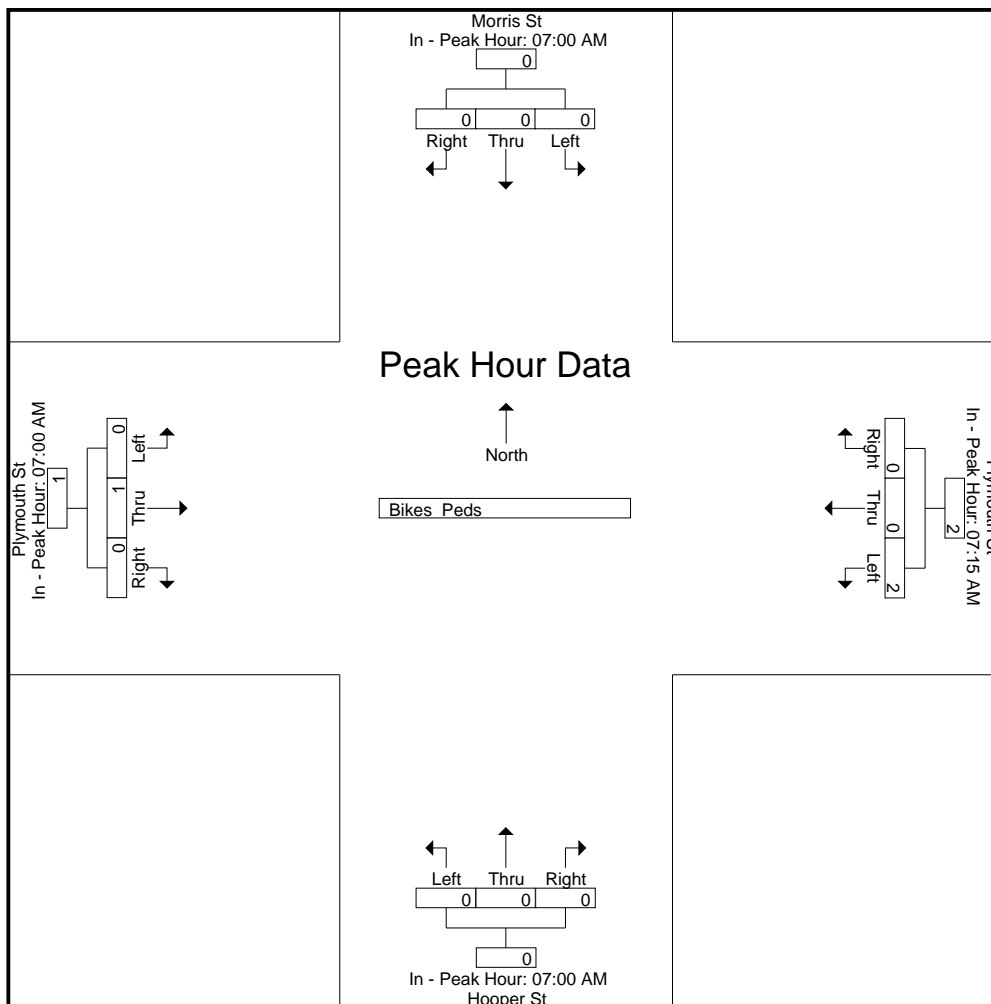

# Accurate Counts

978-664-2565

N/S Street : Morris St / Hooper St  
 E/W Street : Plymouth Street  
 City/State : Bridgewater, MA  
 Weather : Clear

File Name : 20270B18  
 Site Code : 20270018  
 Start Date : 10/2/2024  
 Page No : 1

### Groups Printed- Cars - Trucks

Start Time	Morris St From North			Plymouth St From East			Hooper St From South			Plymouth St From West			Int. Total
	Left	Thru	Right	Left	Thru	Right	Left	Thru	Right	Left	Thru	Right	
04:00 PM	0	0	4	3	100	0	40	0	12	2	133	9	303
04:15 PM	0	0	2	8	105	0	40	0	6	0	112	11	284
04:30 PM	0	0	0	4	119	0	50	1	17	2	140	9	342
04:45 PM	0	0	0	2	115	0	22	0	10	2	146	5	302
<b>Total</b>	<b>0</b>	<b>0</b>	<b>6</b>	<b>17</b>	<b>439</b>	<b>0</b>	<b>152</b>	<b>1</b>	<b>45</b>	<b>6</b>	<b>531</b>	<b>34</b>	<b>1231</b>
05:00 PM	1	0	1	3	133	1	41	0	6	0	141	1	328
05:15 PM	1	0	0	2	155	3	33	0	2	1	145	5	347
05:30 PM	0	0	2	2	117	0	24	0	9	2	132	2	290
05:45 PM	0	0	0	6	142	1	39	0	8	2	131	6	335
<b>Total</b>	<b>2</b>	<b>0</b>	<b>3</b>	<b>13</b>	<b>547</b>	<b>5</b>	<b>137</b>	<b>0</b>	<b>25</b>	<b>5</b>	<b>549</b>	<b>14</b>	<b>1300</b>
<b>Grand Total</b>	<b>2</b>	<b>0</b>	<b>9</b>	<b>30</b>	<b>986</b>	<b>5</b>	<b>289</b>	<b>1</b>	<b>70</b>	<b>11</b>	<b>1080</b>	<b>48</b>	<b>2531</b>
Apprch %	18.2	0	81.8	2.9	96.6	0.5	80.3	0.3	19.4	1	94.8	4.2	
Total %	0.1	0	0.4	1.2	39	0.2	11.4	0	2.8	0.4	42.7	1.9	
Cars	2	0	9	30	972	5	281	1	67	11	1064	48	2490
% Cars	100	0	100	100	98.6	100	97.2	100	95.7	100	98.5	100	98.4
Trucks	0	0	0	0	14	0	8	0	3	0	16	0	41
% Trucks	0	0	0	0	1.4	0	2.8	0	4.3	0	1.5	0	1.6

Start Time	Morris St From North				Plymouth St From East				Hooper St From South				Plymouth St From West				Int. Total
	Left	Thru	Right	App. Total	Left	Thru	Right	App. Total	Left	Thru	Right	App. Total	Left	Thru	Right	App. Total	
Peak Hour Analysis From 04:00 PM to 05:45 PM - Peak 1 of 1																	
Peak Hour for Entire Intersection Begins at 04:30 PM																	
04:30 PM	0	0	0	0	4	119	0	123	50	1	17	68	2	140	9	151	342
04:45 PM	0	0	0	0	2	115	0	117	22	0	10	32	2	146	5	153	302
05:00 PM	1	0	1	2	3	133	1	137	41	0	6	47	0	141	1	142	328
05:15 PM	1	0	0	1	2	155	3	160	33	0	2	35	1	145	5	151	347
<b>Total Volume</b>	<b>2</b>	<b>0</b>	<b>1</b>	<b>3</b>	<b>11</b>	<b>522</b>	<b>4</b>	<b>537</b>	<b>146</b>	<b>1</b>	<b>35</b>	<b>182</b>	<b>5</b>	<b>572</b>	<b>20</b>	<b>597</b>	<b>1319</b>
% App. Total	66.7	0	33.3		2	97.2	0.7		80.2	0.5	19.2		0.8	95.8	3.4		
PHF	.500	.000	.250	.375	.688	.842	.333	.839	.730	.250	.515	.669	.625	.979	.556	.975	.950
Cars	2	0	1	3	11	516	4	531	140	1	34	175	5	565	20	590	1299
% Cars	100	0	100	100	100	98.9	100	98.9	95.9	100	97.1	96.2	100	98.8	100	98.8	98.5
Trucks	0	0	0	0	0	6	0	6	6	0	1	7	0	7	0	7	20
% Trucks	0	0	0	0	0	1.1	0	1.1	4.1	0	2.9	3.8	0	1.2	0	1.2	1.5

# Accurate Counts

978-664-2565

N/S Street : Morris St / Hooper St  
 E/W Street : Plymouth Street  
 City/State : Bridgewater, MA  
 Weather : Clear

File Name : 20270B18  
 Site Code : 20270018  
 Start Date : 10/2/2024  
 Page No : 2

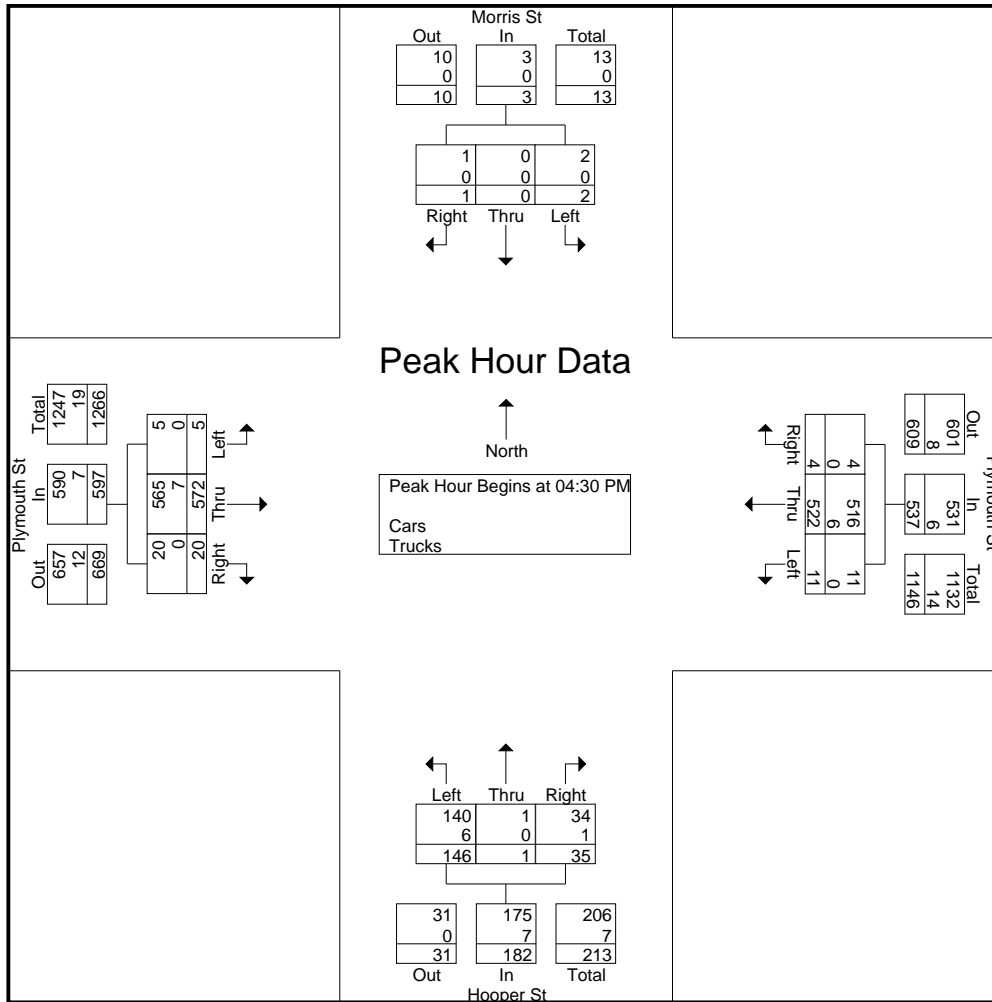

**Peak Hour Analysis From 04:00 PM to 05:45 PM - Peak 1 of 1**

**Peak Hour for Each Approach Begins at:**

	04:00 PM				05:00 PM				04:00 PM				04:30 PM			
+0 mins.	0	0	4	4	3	133	1	137	40	0	12	52	2	140	9	151
+15 mins.	0	0	2	2	2	155	3	160	40	0	6	46	2	146	5	153
+30 mins.	0	0	0	0	2	117	0	119	50	1	17	68	0	141	1	142
+45 mins.	0	0	0	0	6	142	1	149	22	0	10	32	1	145	5	151
Total Volume	0	0	6	6	13	547	5	565	152	1	45	198	5	572	20	597
% App. Total	0	0	100		2.3	96.8	0.9		76.8	0.5	22.7		0.8	95.8	3.4	
PHF	.000	.000	.375	.375	.542	.882	.417	.883	.760	.250	.662	.728	.625	.979	.556	.975
Cars	0	0	6	6	13	542	5	560	147	1	44	192	5	565	20	590
% Cars	0	0	100	100	100	99.1	100	99.1	96.7	100	97.8	97	100	98.8	100	98.8
Trucks	0	0	0	0	0	5	0	5	5	0	1	6	0	7	0	7
% Trucks	0	0	0	0	0	0.9	0	0.9	3.3	0	2.2	3	0	1.2	0	1.2

# Accurate Counts

978-664-2565

File Name : 20270B18

Site Code : 20270018

Start Date : 10/2/2024

Page No : 3

N/S Street : Morris St / Hooper St

E/W Street : Plymouth Street

City/State : Bridgewater, MA

Weather : Clear

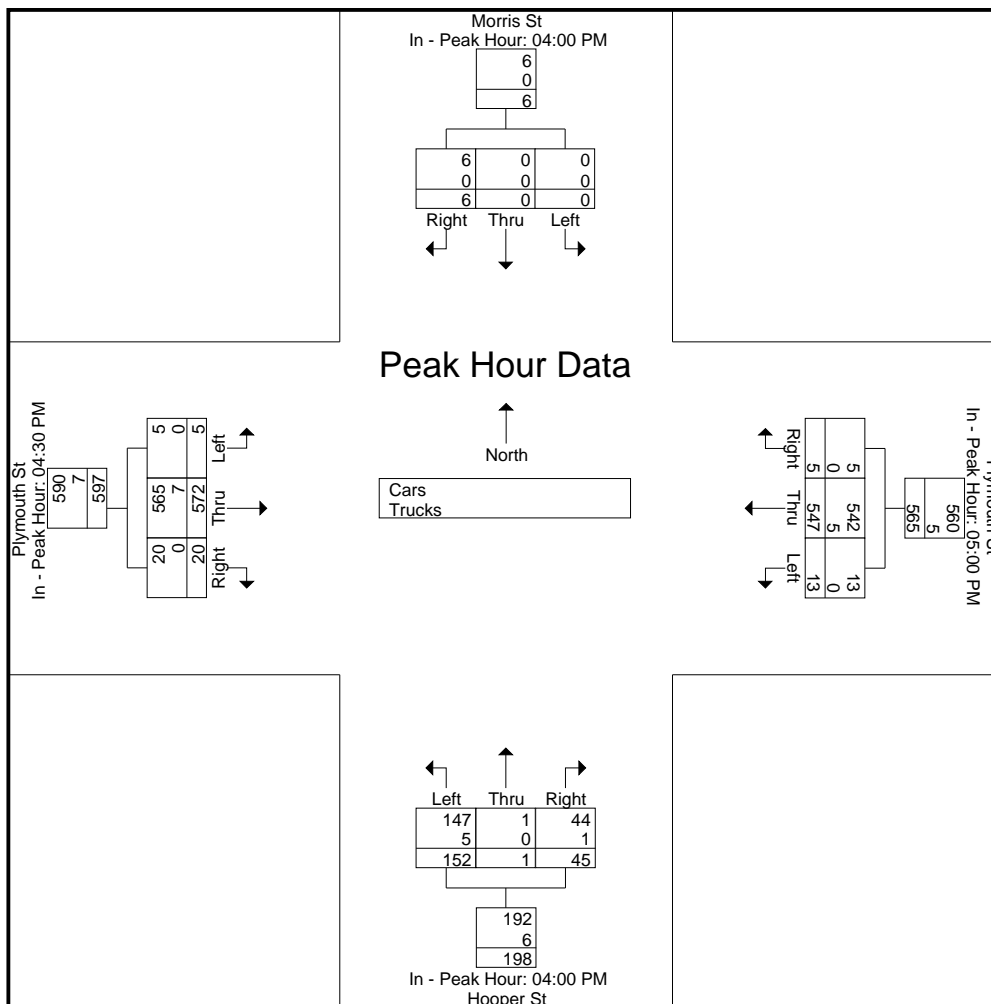

# Accurate Counts

978-664-2565

N/S Street : Morris St / Hooper St  
 E/W Street : Plymouth Street  
 City/State : Bridgewater, MA  
 Weather : Clear

File Name : 20270B18  
 Site Code : 20270018  
 Start Date : 10/2/2024  
 Page No : 4

## Groups Printed- Cars

Start Time	Morris St From North			Plymouth St From East			Hooper St From South			Plymouth St From West			Int. Total
	Left	Thru	Right	Left	Thru	Right	Left	Thru	Right	Left	Thru	Right	
04:00 PM	0	0	4	3	98	0	39	0	12	2	127	9	294
04:15 PM	0	0	2	8	101	0	39	0	6	0	110	11	277
04:30 PM	0	0	0	4	117	0	48	1	16	2	138	9	335
04:45 PM	0	0	0	2	114	0	21	0	10	2	142	5	296
<b>Total</b>	<b>0</b>	<b>0</b>	<b>6</b>	<b>17</b>	<b>430</b>	<b>0</b>	<b>147</b>	<b>1</b>	<b>44</b>	<b>6</b>	<b>517</b>	<b>34</b>	<b>1202</b>
05:00 PM	1	0	1	3	131	1	39	0	6	0	141	1	324
05:15 PM	1	0	0	2	154	3	32	0	2	1	144	5	344
05:30 PM	0	0	2	2	116	0	24	0	8	2	131	2	287
05:45 PM	0	0	0	6	141	1	39	0	7	2	131	6	333
<b>Total</b>	<b>2</b>	<b>0</b>	<b>3</b>	<b>13</b>	<b>542</b>	<b>5</b>	<b>134</b>	<b>0</b>	<b>23</b>	<b>5</b>	<b>547</b>	<b>14</b>	<b>1288</b>
<b>Grand Total</b>	<b>2</b>	<b>0</b>	<b>9</b>	<b>30</b>	<b>972</b>	<b>5</b>	<b>281</b>	<b>1</b>	<b>67</b>	<b>11</b>	<b>1064</b>	<b>48</b>	<b>2490</b>
Apprch %	18.2	0	81.8	3	96.5	0.5	80.5	0.3	19.2	1	94.7	4.3	
Total %	0.1	0	0.4	1.2	39	0.2	11.3	0	2.7	0.4	42.7	1.9	

Start Time	Morris St From North				Plymouth St From East				Hooper St From South				Plymouth St From West				Int. Total
	Left	Thru	Right	App. Total	Left	Thru	Right	App. Total	Left	Thru	Right	App. Total	Left	Thru	Right	App. Total	
<b>Peak Hour Analysis From 04:00 PM to 05:45 PM - Peak 1 of 1</b>																	
<b>Peak Hour for Entire Intersection Begins at 04:30 PM</b>																	
04:30 PM	0	0	0	0	<b>4</b>	117	0	121	<b>48</b>	<b>1</b>	<b>16</b>	<b>65</b>	<b>2</b>	138	<b>9</b>	149	335
04:45 PM	0	0	0	0	2	114	0	116	21	0	10	31	2	142	5	149	296
05:00 PM	<b>1</b>	0	<b>1</b>	<b>2</b>	3	131	1	135	39	0	6	45	0	141	1	142	324
05:15 PM	1	0	0	1	2	<b>154</b>	<b>3</b>	<b>159</b>	32	0	2	34	1	<b>144</b>	5	<b>150</b>	<b>344</b>
<b>Total Volume</b>	<b>2</b>	<b>0</b>	<b>1</b>	<b>3</b>	<b>11</b>	<b>516</b>	<b>4</b>	<b>531</b>	<b>140</b>	<b>1</b>	<b>34</b>	<b>175</b>	<b>5</b>	<b>565</b>	<b>20</b>	<b>590</b>	<b>1299</b>
% App. Total	66.7	0	33.3		2.1	97.2	0.8		80	0.6	19.4		0.8	95.8	3.4		
PHF	.500	.000	.250	.375	.688	.838	.333	.835	.729	.250	.531	.673	.625	.981	.556	.983	.944



# Accurate Counts

978-664-2565

N/S Street : Morris St / Hooper St  
 E/W Street : Plymouth Street  
 City/State : Bridgewater, MA  
 Weather : Clear

File Name : 20270B18  
 Site Code : 20270018  
 Start Date : 10/2/2024  
 Page No : 5

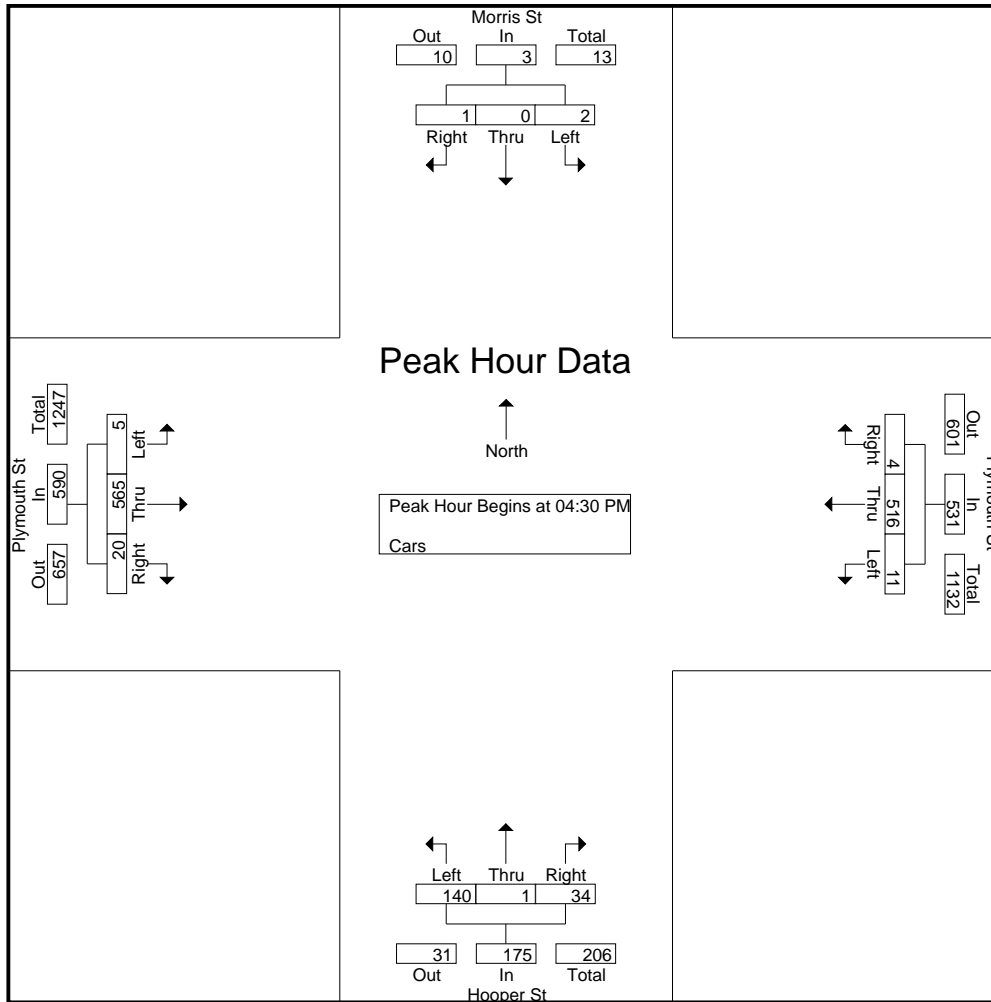

**Peak Hour Analysis From 04:00 PM to 05:45 PM - Peak 1 of 1**

Peak Hour for Each Approach Begins at:

	04:00 PM				05:00 PM				04:00 PM				04:30 PM			
+0 mins.	0	0	4	4	3	131	1	135	39	0	12	51	2	138	9	149
+15 mins.	0	0	2	2	2	154	3	159	39	0	6	45	2	142	5	149
+30 mins.	0	0	0	0	2	116	0	118	48	1	16	65	0	141	1	142
+45 mins.	0	0	0	0	6	141	1	148	21	0	10	31	1	144	5	150
Total Volume	0	0	6	6	13	542	5	560	147	1	44	192	5	565	20	590
% App. Total	0	0	100		2.3	96.8	0.9		76.6	0.5	22.9		0.8	95.8	3.4	
PHF	.000	.000	.375	.375	.542	.880	.417	.881	.766	.250	.688	.738	.625	.981	.556	.983

# Accurate Counts

978-664-2565

File Name : 20270B18

Site Code : 20270018

Start Date : 10/2/2024

Page No : 6

N/S Street : Morris St / Hooper St

E/W Street : Plymouth Street

City/State : Bridgewater, MA

Weather : Clear

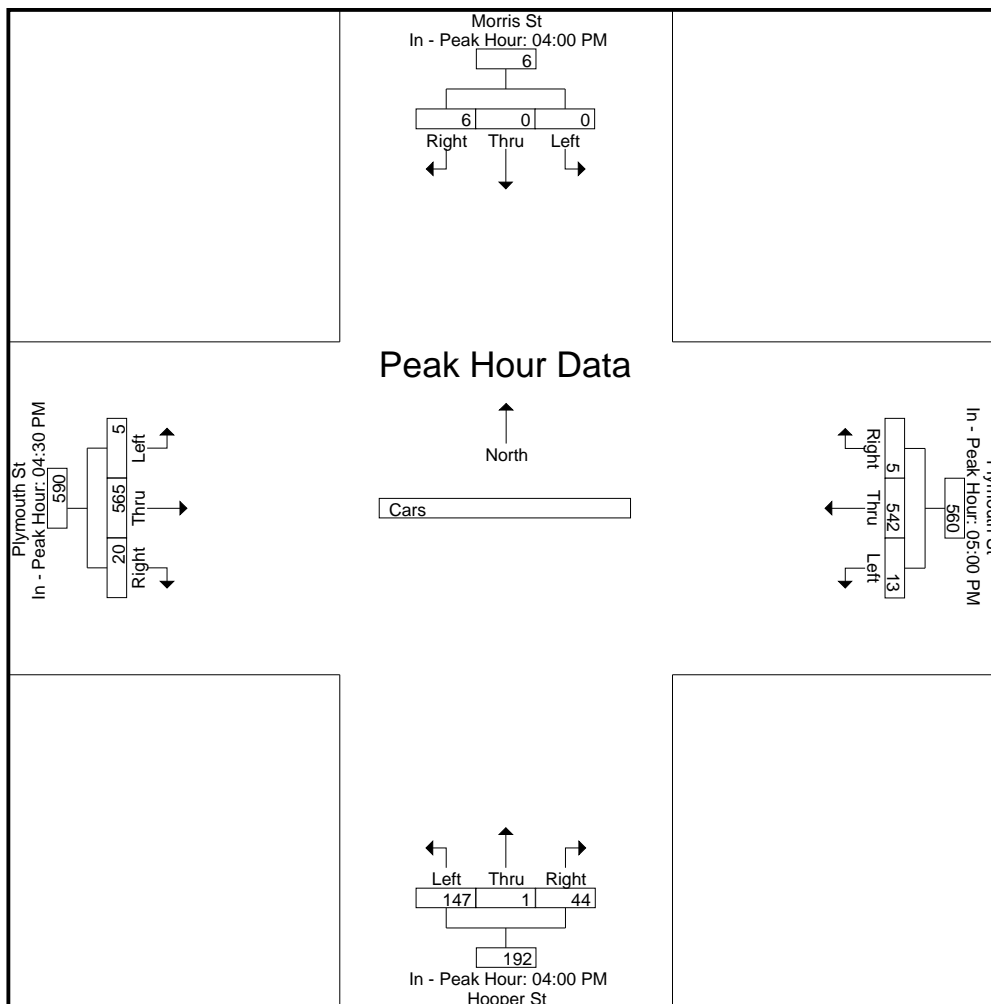

# Accurate Counts

978-664-2565

N/S Street : Morris St / Hooper St  
 E/W Street : Plymouth Street  
 City/State : Bridgewater, MA  
 Weather : Clear

File Name : 20270B18  
 Site Code : 20270018  
 Start Date : 10/2/2024  
 Page No : 7

### Groups Printed- Trucks

Start Time	Morris St From North			Plymouth St From East			Hooper St From South			Plymouth St From West			Int. Total
	Left	Thru	Right	Left	Thru	Right	Left	Thru	Right	Left	Thru	Right	
04:00 PM	0	0	0	0	2	0	1	0	0	0	6	0	9
04:15 PM	0	0	0	0	4	0	1	0	0	0	2	0	7
04:30 PM	0	0	0	0	2	0	2	0	1	0	2	0	7
04:45 PM	0	0	0	0	1	0	1	0	0	0	4	0	6
<b>Total</b>	0	0	0	0	9	0	5	0	1	0	14	0	29
05:00 PM	0	0	0	0	2	0	2	0	0	0	0	0	4
05:15 PM	0	0	0	0	1	0	1	0	0	0	1	0	3
05:30 PM	0	0	0	0	1	0	0	0	1	0	1	0	3
05:45 PM	0	0	0	0	1	0	0	0	1	0	0	0	2
<b>Total</b>	0	0	0	0	5	0	3	0	2	0	2	0	12
<b>Grand Total</b>	0	0	0	0	14	0	8	0	3	0	16	0	41
Apprch %	0	0	0	0	100	0	72.7	0	27.3	0	100	0	
Total %	0	0	0	0	34.1	0	19.5	0	7.3	0	39	0	

Start Time	Morris St From North				Plymouth St From East				Hooper St From South				Plymouth St From West				Int. Total
	Left	Thru	Right	App. Total	Left	Thru	Right	App. Total	Left	Thru	Right	App. Total	Left	Thru	Right	App. Total	
<b>Peak Hour Analysis From 04:00 PM to 05:45 PM - Peak 1 of 1</b>																	
<b>Peak Hour for Entire Intersection Begins at 04:00 PM</b>																	
04:00 PM	0	0	0	0	0	2	0	2	1	0	0	1	0	6	0	6	9
04:15 PM	0	0	0	0	0	4	0	4	1	0	0	1	0	2	0	2	7
04:30 PM	0	0	0	0	0	2	0	2	2	0	1	3	0	2	0	2	7
04:45 PM	0	0	0	0	0	1	0	1	1	0	0	1	0	4	0	4	6
<b>Total Volume</b>	0	0	0	0	0	9	0	9	5	0	1	6	0	14	0	14	29
<b>% App. Total</b>	0	0	0	0	0	100	0	100	83.3	0	16.7	100	0	100	0	100	
PHF	.000	.000	.000	.000	.000	.563	.000	.563	.625	.000	.250	.500	.000	.583	.000	.583	.806

# Accurate Counts

978-664-2565

N/S Street : Morris St / Hooper St  
 E/W Street : Plymouth Street  
 City/State : Bridgewater, MA  
 Weather : Clear

File Name : 20270B18  
 Site Code : 20270018  
 Start Date : 10/2/2024  
 Page No : 8

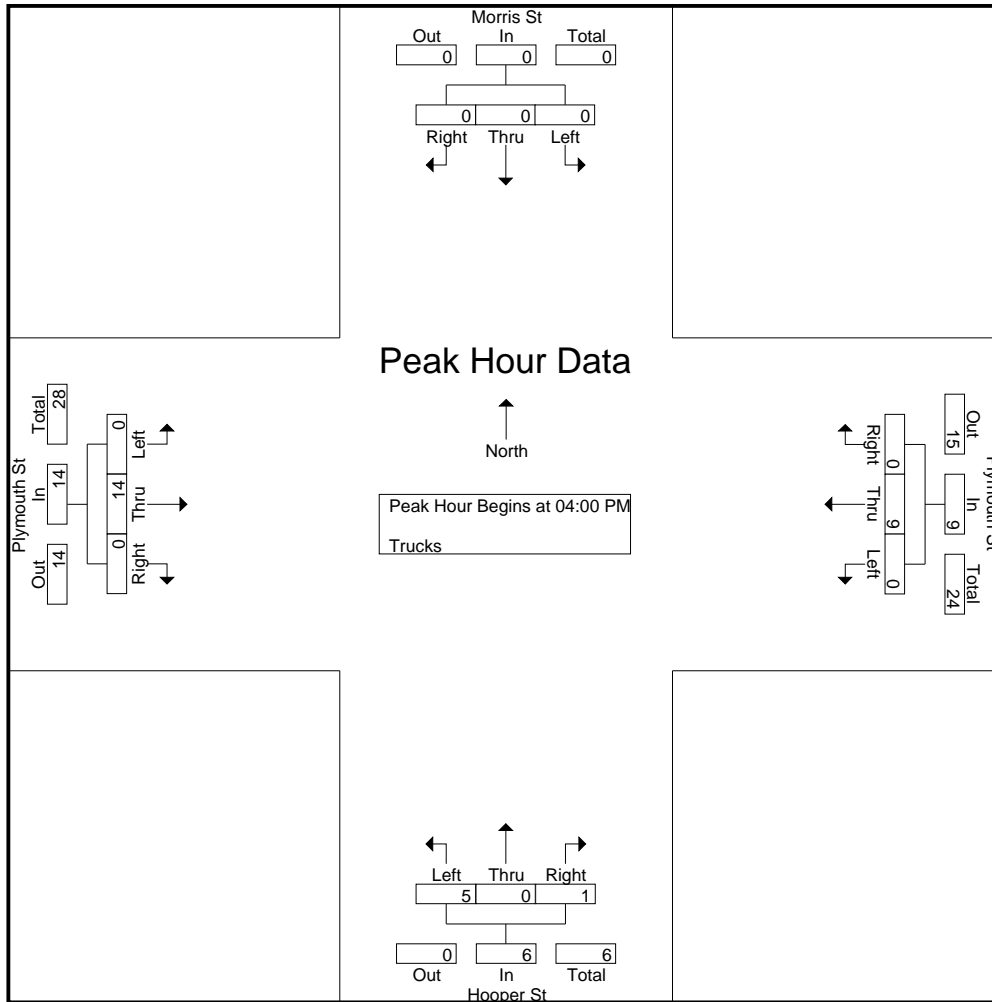

**Peak Hour Analysis From 04:00 PM to 05:45 PM - Peak 1 of 1**

**Peak Hour for Each Approach Begins at:**

	04:00 PM				04:00 PM				04:15 PM				04:00 PM			
+0 mins.	0	0	0	0	0	2	0	2	1	0	0	1	0	6	0	6
+15 mins.	0	0	0	0	0	4	0	4	2	0	1	3	0	2	0	2
+30 mins.	0	0	0	0	0	2	0	2	1	0	0	1	0	2	0	2
+45 mins.	0	0	0	0	0	1	0	1	2	0	0	2	0	4	0	4
Total Volume	0	0	0	0	0	9	0	9	6	0	1	7	0	14	0	14
% App. Total	0	0	0	0	0	100	0	0	85.7	0	14.3	0	0	100	0	0
PHF	.000	.000	.000	.000	.000	.563	.000	.563	.750	.000	.250	.583	.000	.583	.000	.583

# Accurate Counts

978-664-2565

File Name : 20270B18

Site Code : 20270018

Start Date : 10/2/2024

Page No : 9

N/S Street : Morris St / Hooper St

E/W Street : Plymouth Street

City/State : Bridgewater, MA

Weather : Clear

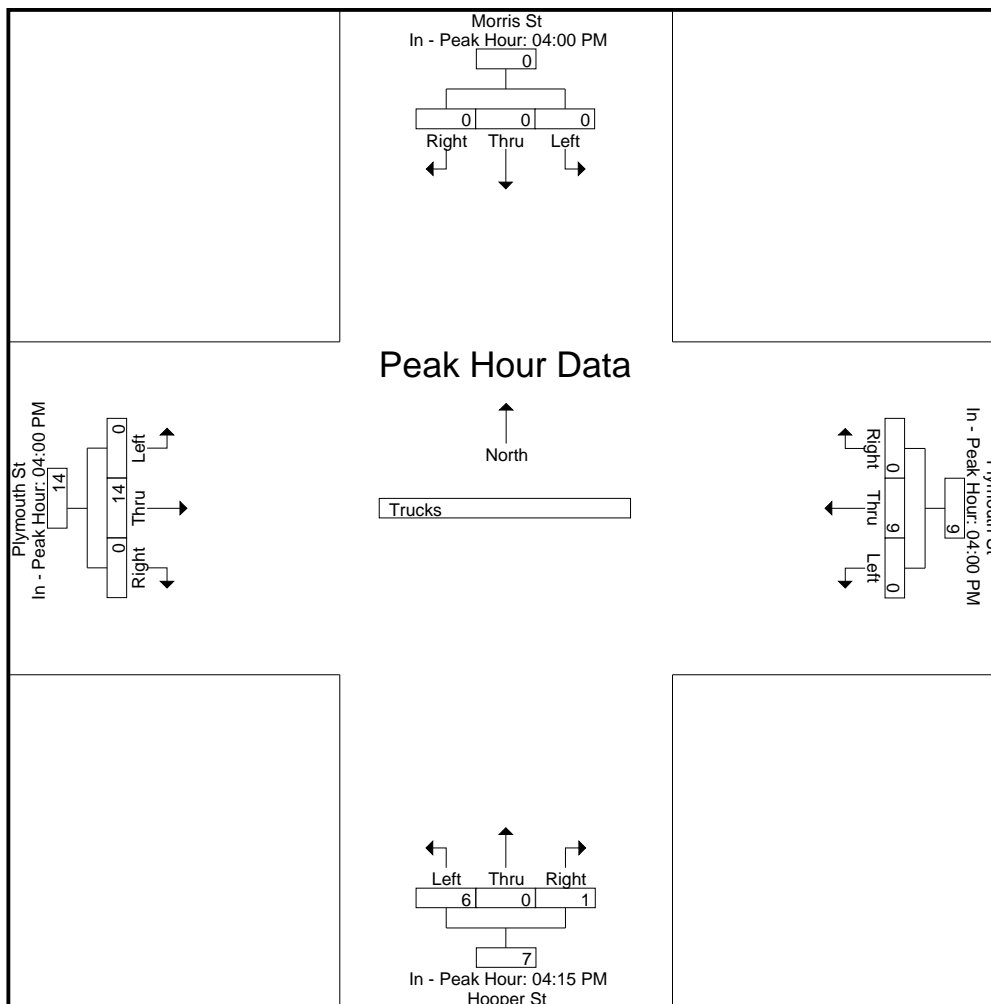

# Accurate Counts

978-664-2565

N/S Street : Morris St / Hooper St  
 E/W Street : Plymouth Street  
 City/State : Bridgewater, MA  
 Weather : Clear

File Name : 20270B18  
 Site Code : 20270018  
 Start Date : 10/2/2024  
 Page No : 10

## Groups Printed- Bikes Peds

Start Time	Morris St From North				Plymouth St From East				Hooper St From South				Plymouth St From West				Exclu. Total	Inclu. Total	Int. Total
	Left	Thru	Right	Peds	Left	Thru	Right	Peds	Left	Thru	Right	Peds	Left	Thru	Right	Peds			
04:00 PM	0	0	0	1	0	0	0	1	0	0	0	1	0	0	0	0	3	0	3
04:15 PM	0	0	0	2	0	0	0	0	0	0	0	2	0	0	0	0	4	0	4
04:30 PM	0	0	0	2	0	0	0	0	0	0	0	0	0	0	0	0	2	0	2
04:45 PM	0	0	0	0	0	2	0	0	0	0	0	0	0	0	0	0	0	2	2
<b>Total</b>	0	0	0	5	0	2	0	1	0	0	0	3	0	0	0	0	9	2	11
05:00 PM	0	0	0	0	0	0	0	0	0	0	0	0	0	0	0	0	0	0	0
05:15 PM	0	0	0	6	0	0	0	1	0	0	0	1	0	0	0	0	8	0	8
05:30 PM	0	0	0	4	0	0	0	0	0	0	0	2	0	0	0	0	6	0	6
05:45 PM	0	0	0	4	0	0	0	2	0	0	0	1	0	0	0	1	8	0	8
<b>Total</b>	0	0	0	14	0	0	0	3	0	0	0	4	0	0	0	1	22	0	22
<b>Grand Total</b>	0	0	0	19	0	2	0	4	0	0	0	7	0	0	0	1	31	2	33
Apprch %	0	0	0		0	100	0		0	0	0		0	0	0				
Total %	0	0	0		0	100	0		0	0	0		0	0	0		93.9	6.1	

Start Time	Morris St From North				Plymouth St From East				Hooper St From South				Plymouth St From West				Int. Total
	Left	Thru	Right	App. Total	Left	Thru	Right	App. Total	Left	Thru	Right	App. Total	Left	Thru	Right	App. Total	
Peak Hour Analysis From 04:00 PM to 05:45 PM - Peak 1 of 1																	
Peak Hour for Entire Intersection Begins at 04:00 PM																	
04:00 PM	0	0	0	0	0	0	0	0	0	0	0	0	0	0	0	0	0
04:15 PM	0	0	0	0	0	0	0	0	0	0	0	0	0	0	0	0	0
04:30 PM	0	0	0	0	0	0	0	0	0	0	0	0	0	0	0	0	0
04:45 PM	0	0	0	0	0	2	0	2	0	0	0	0	0	0	0	0	2
<b>Total Volume</b>	0	0	0	0	0	2	0	2	0	0	0	0	0	0	0	0	2
<b>% App. Total</b>	0	0	0		0	100	0		0	0	0		0	0	0		
PHF	.000	.000	.000	.000	.000	.250	.000	.250	.000	.000	.000	.000	.000	.000	.000	.000	.250

# Accurate Counts

978-664-2565

N/S Street : Morris St / Hooper St  
 E/W Street : Plymouth Street  
 City/State : Bridgewater, MA  
 Weather : Clear

File Name : 20270B18  
 Site Code : 20270018  
 Start Date : 10/2/2024  
 Page No : 11

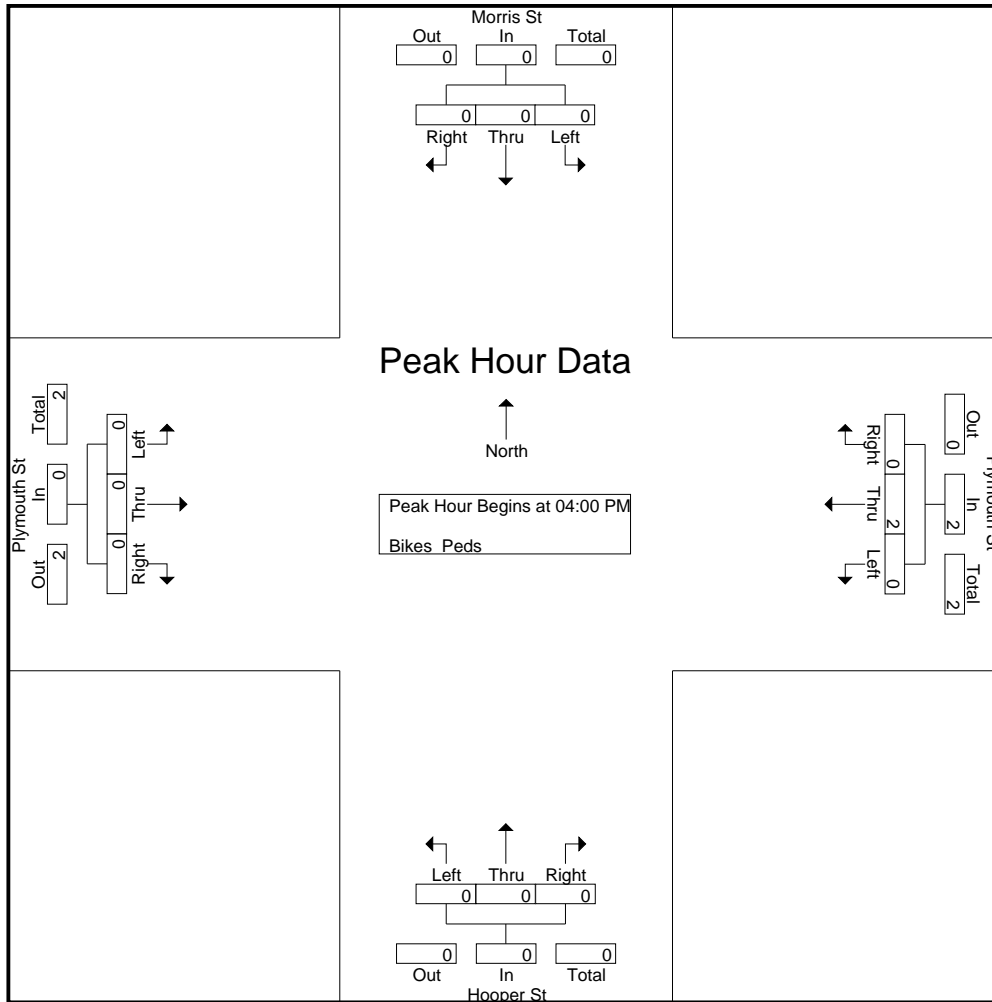

**Peak Hour Analysis From 04:00 PM to 05:45 PM - Peak 1 of 1**

**Peak Hour for Each Approach Begins at:**

	04:00 PM				04:00 PM				04:00 PM				04:00 PM			
+0 mins.	0	0	0	0	0	0	0	0	0	0	0	0	0	0	0	0
+15 mins.	0	0	0	0	0	0	0	0	0	0	0	0	0	0	0	0
+30 mins.	0	0	0	0	0	0	0	0	0	0	0	0	0	0	0	0
+45 mins.	0	0	0	0	0	2	0	2	0	0	0	0	0	0	0	0
Total Volume	0	0	0	0	0	2	0	2	0	0	0	0	0	0	0	0
% App. Total	0	0	0	0	0	100	0	0	0	0	0	0	0	0	0	0
PHF	.000	.000	.000	.000	.000	.250	.000	.250	.000	.000	.000	.000	.000	.000	.000	.000

# Accurate Counts

978-664-2565

N/S Street : Morris St / Hooper St  
E/W Street : Plymouth Street  
City/State : Bridgewater, MA  
Weather : Clear

File Name : 20270B18  
Site Code : 20270018  
Start Date : 10/2/2024  
Page No : 12

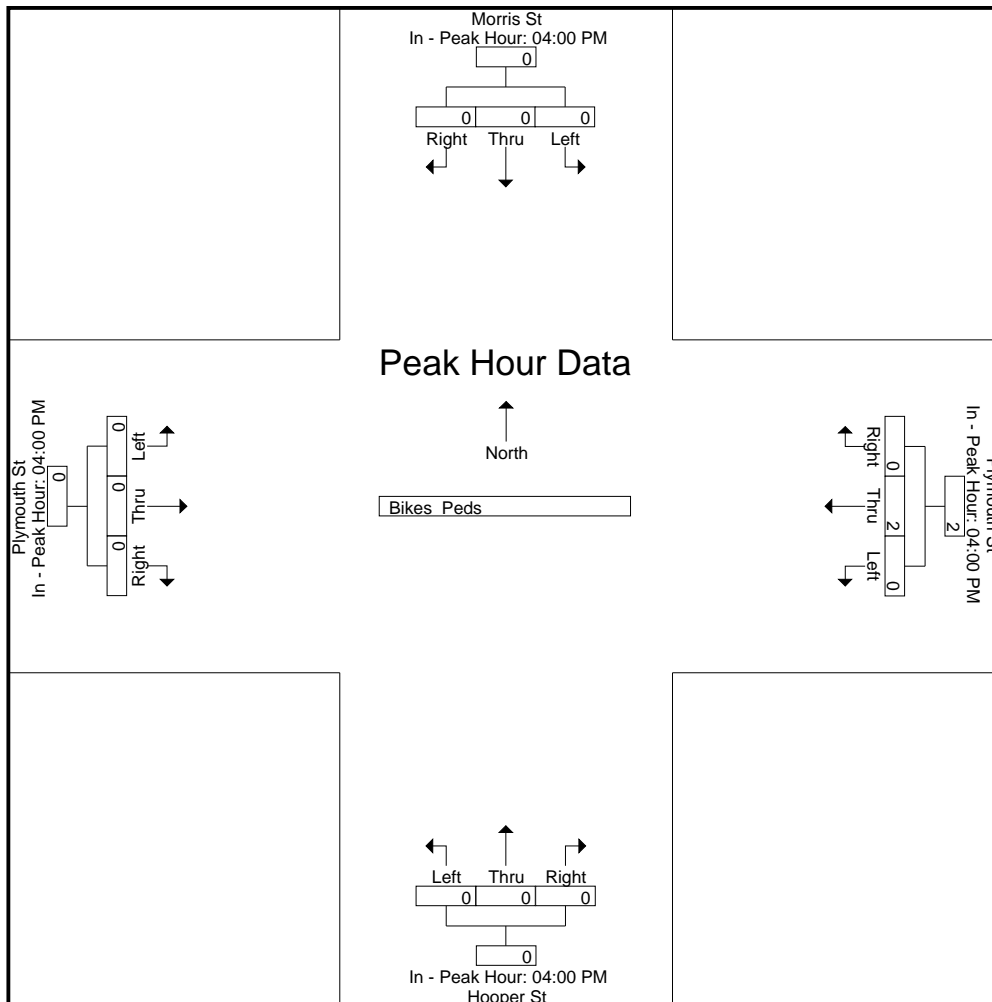



# Accurate Counts

978-664-2565

N/S Street : Hayward St / Great Hill Dr  
 E/W Street : Plymouth Street  
 City/State : Bridgewater, MA  
 Weather : Clear

File Name : 20270B19  
 Site Code : 20270019  
 Start Date : 10/2/2024  
 Page No : 1

### Groups Printed- Cars - Trucks

Start Time	Hayward St From North			Plymouth St From East			Great Hill Dr From South			Plymouth St From West			Int. Total
	Left	Thru	Right	Left	Thru	Right	Left	Thru	Right	Left	Thru	Right	
07:00 AM	1	3	10	5	88	6	3	4	4	5	51	1	181
07:15 AM	3	3	9	7	92	6	0	1	2	6	44	3	176
07:30 AM	6	3	14	6	105	6	1	1	2	5	47	5	201
07:45 AM	2	13	11	22	97	5	4	0	6	4	46	10	220
<b>Total</b>	<b>12</b>	<b>22</b>	<b>44</b>	<b>40</b>	<b>382</b>	<b>23</b>	<b>8</b>	<b>6</b>	<b>14</b>	<b>20</b>	<b>188</b>	<b>19</b>	<b>778</b>
08:00 AM	2	2	13	7	99	4	4	3	3	7	68	0	212
08:15 AM	6	0	7	7	79	6	7	1	8	9	54	4	188
08:30 AM	2	4	11	10	114	7	4	3	5	8	58	4	230
08:45 AM	3	4	12	3	88	5	12	2	1	9	39	3	181
<b>Total</b>	<b>13</b>	<b>10</b>	<b>43</b>	<b>27</b>	<b>380</b>	<b>22</b>	<b>27</b>	<b>9</b>	<b>17</b>	<b>33</b>	<b>219</b>	<b>11</b>	<b>811</b>
<b>Grand Total</b>	<b>25</b>	<b>32</b>	<b>87</b>	<b>67</b>	<b>762</b>	<b>45</b>	<b>35</b>	<b>15</b>	<b>31</b>	<b>53</b>	<b>407</b>	<b>30</b>	<b>1589</b>
Apprch %	17.4	22.2	60.4	7.7	87.2	5.1	43.2	18.5	38.3	10.8	83.1	6.1	
Total %	1.6	2	5.5	4.2	48	2.8	2.2	0.9	2	3.3	25.6	1.9	
Cars	21	32	81	67	722	44	29	15	31	52	366	28	1488
% Cars	84	100	93.1	100	94.8	97.8	82.9	100	100	98.1	89.9	93.3	93.6
Trucks	4	0	6	0	40	1	6	0	0	1	41	2	101
% Trucks	16	0	6.9	0	5.2	2.2	17.1	0	0	1.9	10.1	6.7	6.4

Start Time	Hayward St From North				Plymouth St From East				Great Hill Dr From South				Plymouth St From West				Int. Total
	Left	Thru	Right	App. Total	Left	Thru	Right	App. Total	Left	Thru	Right	App. Total	Left	Thru	Right	App. Total	
Peak Hour Analysis From 07:00 AM to 08:45 AM - Peak 1 of 1																	
Peak Hour for Entire Intersection Begins at 07:45 AM																	
07:45 AM	2	<b>13</b>	11	<b>26</b>	<b>22</b>	97	5	124	4	0	6	10	4	46	<b>10</b>	60	220
08:00 AM	2	2	<b>13</b>	17	7	99	4	110	4	<b>3</b>	3	10	7	<b>68</b>	0	<b>75</b>	212
08:15 AM	<b>6</b>	0	7	13	7	79	6	92	<b>7</b>	1	<b>8</b>	<b>16</b>	<b>9</b>	54	4	67	188
08:30 AM	2	4	11	17	10	<b>114</b>	<b>7</b>	<b>131</b>	4	3	5	12	8	58	4	70	<b>230</b>
<b>Total Volume</b>	12	19	42	73	46	389	22	457	19	7	22	48	28	226	18	272	850
% App. Total	16.4	26	57.5		10.1	85.1	4.8		39.6	14.6	45.8		10.3	83.1	6.6		
PHF	.500	.365	.808	.702	.523	.853	.786	.872	.679	.583	.688	.750	.778	.831	.450	.907	.924
Cars	9	19	39	67	46	368	21	435	14	7	22	43	28	199	17	244	789
% Cars	75.0	100	92.9	91.8	100	94.6	95.5	95.2	73.7	100	100	89.6	100	88.1	94.4	89.7	92.8
Trucks	3	0	3	6	0	21	1	22	5	0	0	5	0	27	1	28	61
% Trucks	25.0	0	7.1	8.2	0	5.4	4.5	4.8	26.3	0	0	10.4	0	11.9	5.6	10.3	7.2

# Accurate Counts

978-664-2565

N/S Street : Hayward St / Great Hill Dr

E/W Street : Plymouth Street

City/State : Bridgewater, MA

Weather : Clear

File Name : 20270B19

Site Code : 20270019

Start Date : 10/2/2024

Page No : 2

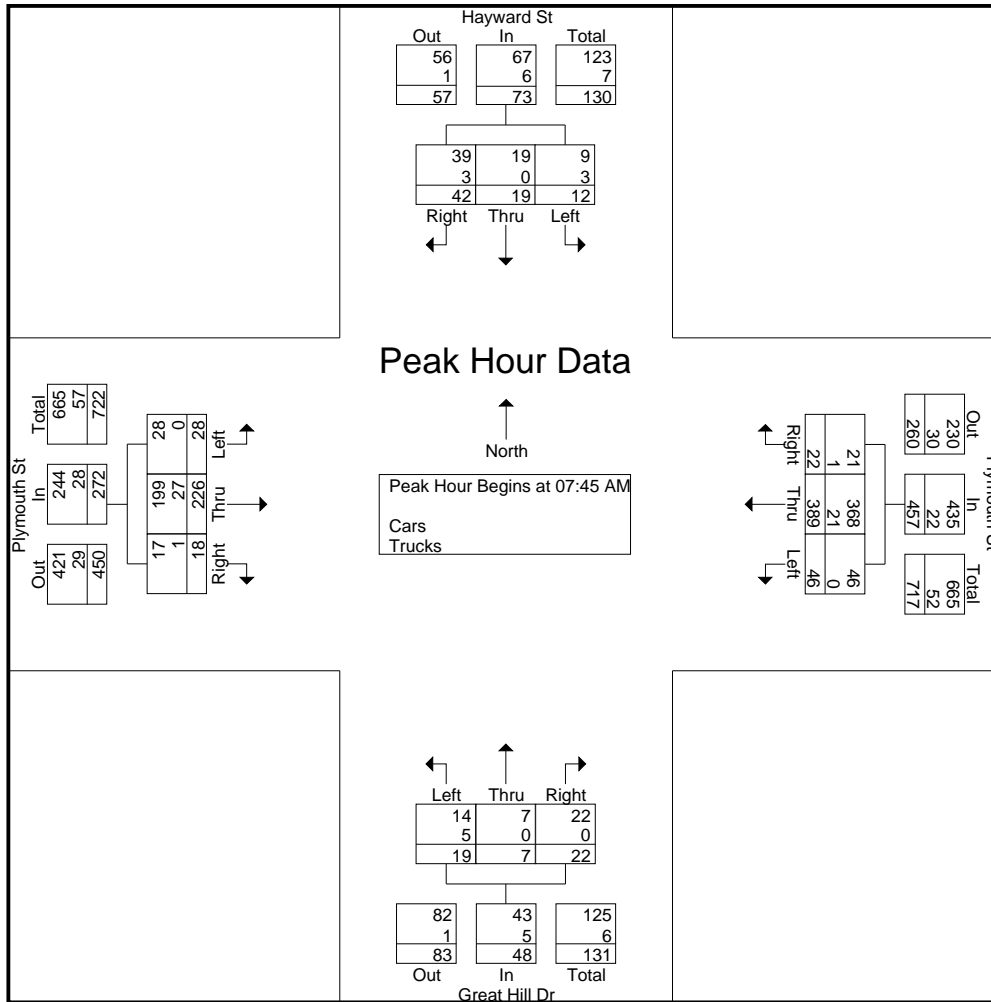

Peak Hour Analysis From 07:00 AM to 08:45 AM - Peak 1 of 1

Peak Hour for Each Approach Begins at:

	07:15 AM				07:45 AM				08:00 AM				07:45 AM			
+0 mins.	3	3	9	15	<b>22</b>	97	5	124	4	<b>3</b>	3	10	4	46	<b>10</b>	60
+15 mins.	<b>6</b>	3	<b>14</b>	23	7	99	4	110	7	1	<b>8</b>	<b>16</b>	7	<b>68</b>	0	<b>75</b>
+30 mins.	2	<b>13</b>	11	<b>26</b>	7	79	6	92	4	3	5	12	<b>9</b>	54	4	67
+45 mins.	2	2	13	17	10	<b>114</b>	<b>7</b>	<b>131</b>	<b>12</b>	2	1	15	8	58	4	70
Total Volume	13	21	47	81	46	389	22	457	27	9	17	53	28	226	18	272
% App. Total	16	25.9	58		10.1	85.1	4.8		50.9	17	32.1		10.3	83.1	6.6	
PHF	.542	.404	.839	.779	.523	.853	.786	.872	.563	.750	.531	.828	.778	.831	.450	.907
Cars	11	21	44	76	46	368	21	435	22	9	17	48	28	199	17	244
% Cars	84.6	100	93.6	93.8	100	94.6	95.5	95.2	81.5	100	100	90.6	100	88.1	94.4	89.7
Trucks	2	0	3	5	0	21	1	22	5	0	0	5	0	27	1	28
% Trucks	15.4	0	6.4	6.2	0	5.4	4.5	4.8	18.5	0	0	9.4	0	11.9	5.6	10.3

# Accurate Counts

978-664-2565

File Name : 20270B19

Site Code : 20270019

Start Date : 10/2/2024

Page No : 3

N/S Street : Hayward St / Great Hill Dr

E/W Street : Plymouth Street

City/State : Bridgewater, MA

Weather : Clear

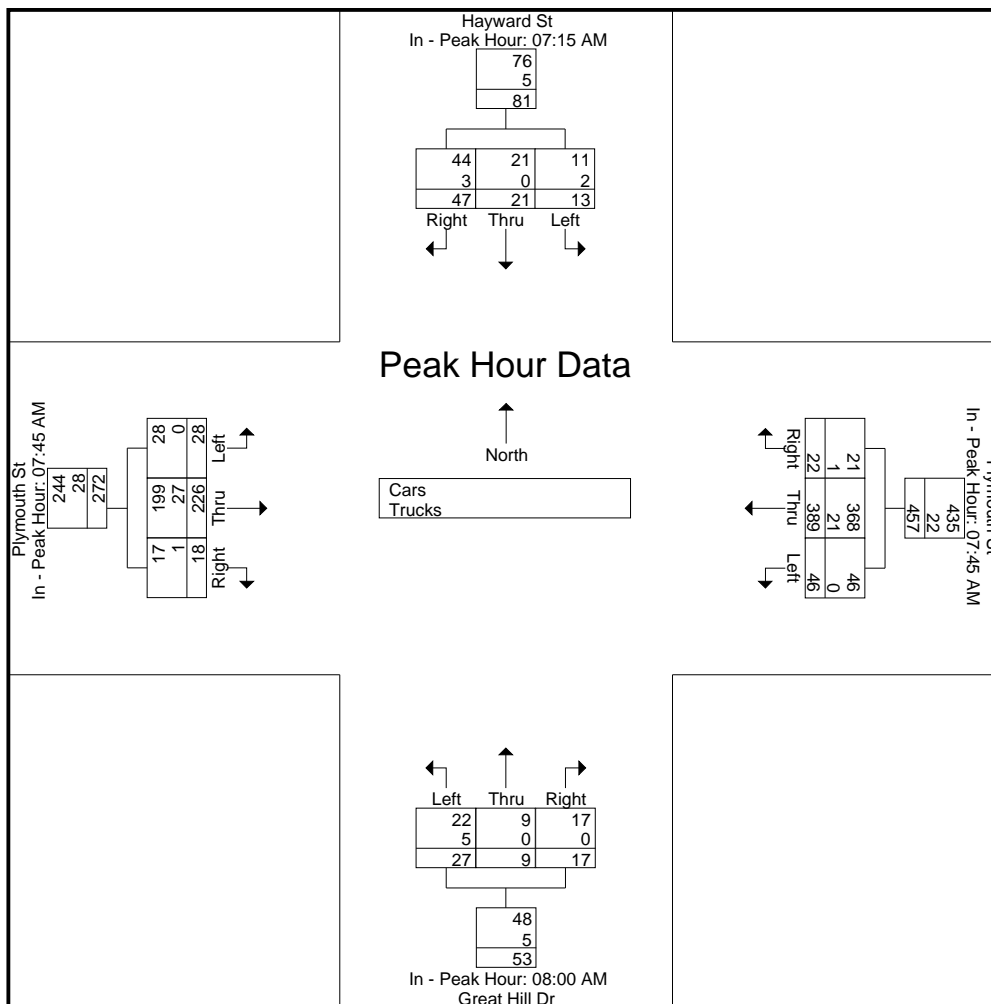

# Accurate Counts

978-664-2565

N/S Street : Hayward St / Great Hill Dr  
 E/W Street : Plymouth Street  
 City/State : Bridgewater, MA  
 Weather : Clear

File Name : 20270B19  
 Site Code : 20270019  
 Start Date : 10/2/2024  
 Page No : 4

## Groups Printed- Cars

Start Time	Hayward St From North			Plymouth St From East			Great Hill Dr From South			Plymouth St From West			Int. Total
	Left	Thru	Right	Left	Thru	Right	Left	Thru	Right	Left	Thru	Right	
07:00 AM	1	3	9	5	82	6	3	4	4	5	47	1	170
07:15 AM	3	3	9	7	90	6	0	1	2	5	42	3	171
07:30 AM	6	3	14	6	100	6	1	1	2	5	43	4	191
07:45 AM	1	13	10	22	95	5	3	0	6	4	42	10	211
<b>Total</b>	<b>11</b>	<b>22</b>	<b>42</b>	<b>40</b>	<b>367</b>	<b>23</b>	<b>7</b>	<b>6</b>	<b>14</b>	<b>19</b>	<b>174</b>	<b>18</b>	<b>743</b>
08:00 AM	1	2	11	7	92	4	4	3	3	7	64	0	198
08:15 AM	5	0	7	7	76	5	5	1	8	9	46	3	172
08:30 AM	2	4	11	10	105	7	2	3	5	8	47	4	208
08:45 AM	2	4	10	3	82	5	11	2	1	9	35	3	167
<b>Total</b>	<b>10</b>	<b>10</b>	<b>39</b>	<b>27</b>	<b>355</b>	<b>21</b>	<b>22</b>	<b>9</b>	<b>17</b>	<b>33</b>	<b>192</b>	<b>10</b>	<b>745</b>
<b>Grand Total</b>	<b>21</b>	<b>32</b>	<b>81</b>	<b>67</b>	<b>722</b>	<b>44</b>	<b>29</b>	<b>15</b>	<b>31</b>	<b>52</b>	<b>366</b>	<b>28</b>	<b>1488</b>
Apprch %	15.7	23.9	60.4	8	86.7	5.3	38.7	20	41.3	11.7	82.1	6.3	
Total %	1.4	2.2	5.4	4.5	48.5	3	1.9	1	2.1	3.5	24.6	1.9	

Start Time	Hayward St From North				Plymouth St From East				Great Hill Dr From South				Plymouth St From West				Int. Total
	Left	Thru	Right	App. Total	Left	Thru	Right	App. Total	Left	Thru	Right	App. Total	Left	Thru	Right	App. Total	
<b>Peak Hour Analysis From 07:00 AM to 08:45 AM - Peak 1 of 1</b>																	
<b>Peak Hour for Entire Intersection Begins at 07:45 AM</b>																	
07:45 AM	1	13	10	24	22	95	5	122	3	0	6	9	4	42	10	56	211
08:00 AM	1	2	11	14	7	92	4	103	4	3	3	10	7	64	0	71	198
08:15 AM	5	0	7	12	7	76	5	88	5	1	8	14	9	46	3	58	172
08:30 AM	2	4	11	17	10	105	7	122	2	3	5	10	8	47	4	59	208
<b>Total Volume</b>	<b>9</b>	<b>19</b>	<b>39</b>	<b>67</b>	<b>46</b>	<b>368</b>	<b>21</b>	<b>435</b>	<b>14</b>	<b>7</b>	<b>22</b>	<b>43</b>	<b>28</b>	<b>199</b>	<b>17</b>	<b>244</b>	<b>789</b>
% App. Total	13.4	28.4	58.2		10.6	84.6	4.8		32.6	16.3	51.2		11.5	81.6	7		
PHF	.450	.365	.886	.698	.523	.876	.750	.891	.700	.583	.688	.768	.778	.777	.425	.859	.935

# Accurate Counts

978-664-2565

N/S Street : Hayward St / Great Hill Dr  
 E/W Street : Plymouth Street  
 City/State : Bridgewater, MA  
 Weather : Clear

File Name : 20270B19  
 Site Code : 20270019  
 Start Date : 10/2/2024  
 Page No : 5

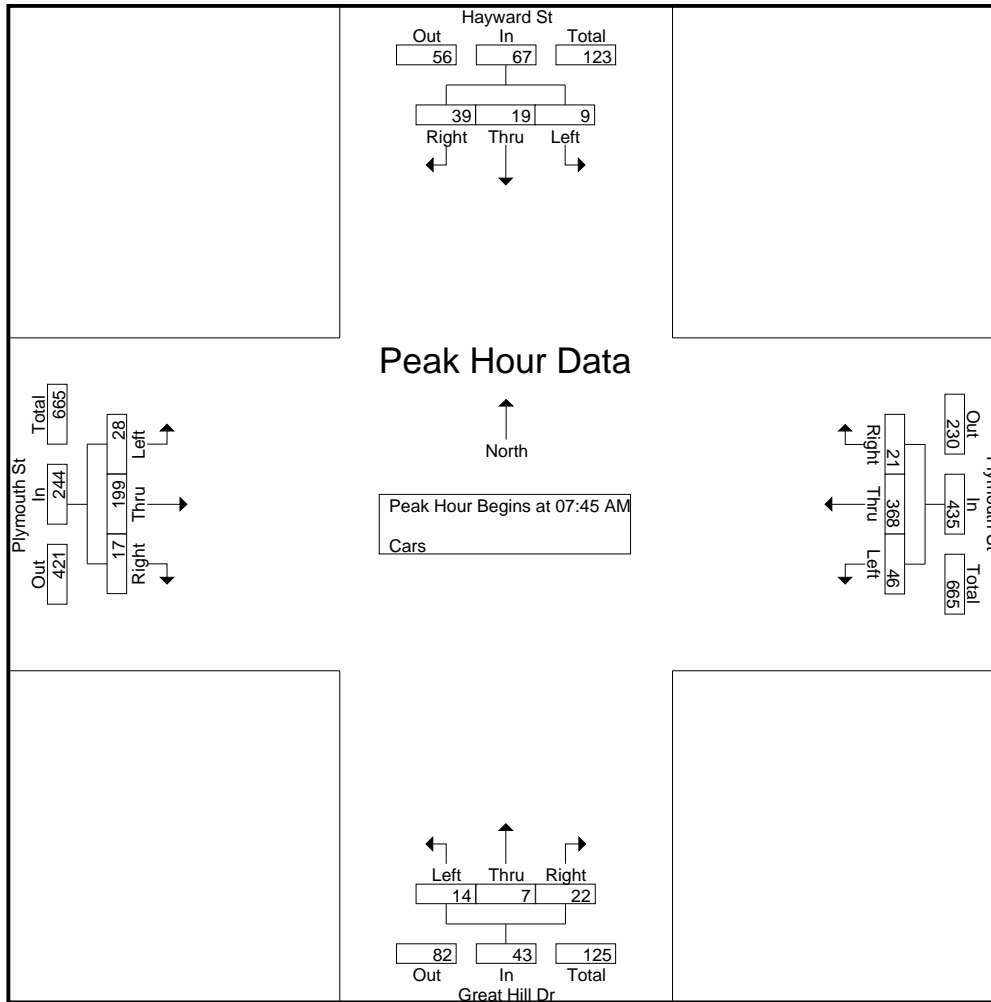

**Peak Hour Analysis From 07:00 AM to 08:45 AM - Peak 1 of 1**

**Peak Hour for Each Approach Begins at:**

	07:15 AM				07:15 AM				08:00 AM				07:45 AM			
+0 mins.	3	3	9	15	7	90	6	103	4	3	3	10	4	42	10	56
+15 mins.	6	3	14	23	6	100	6	112	5	1	8	14	7	64	0	71
+30 mins.	1	13	10	24	22	95	5	122	2	3	5	10	9	46	3	58
+45 mins.	1	2	11	14	7	92	4	103	11	2	1	14	8	47	4	59
Total Volume	11	21	44	76	42	377	21	440	22	9	17	48	28	199	17	244
% App. Total	14.5	27.6	57.9		9.5	85.7	4.8		45.8	18.8	35.4		11.5	81.6	7	
PHF	.458	.404	.786	.792	.477	.943	.875	.902	.500	.750	.531	.857	.778	.777	.425	.859

# Accurate Counts

978-664-2565

File Name : 20270B19

Site Code : 20270019

Start Date : 10/2/2024

Page No : 6

N/S Street : Hayward St / Great Hill Dr

E/W Street : Plymouth Street

City/State : Bridgewater, MA

Weather : Clear

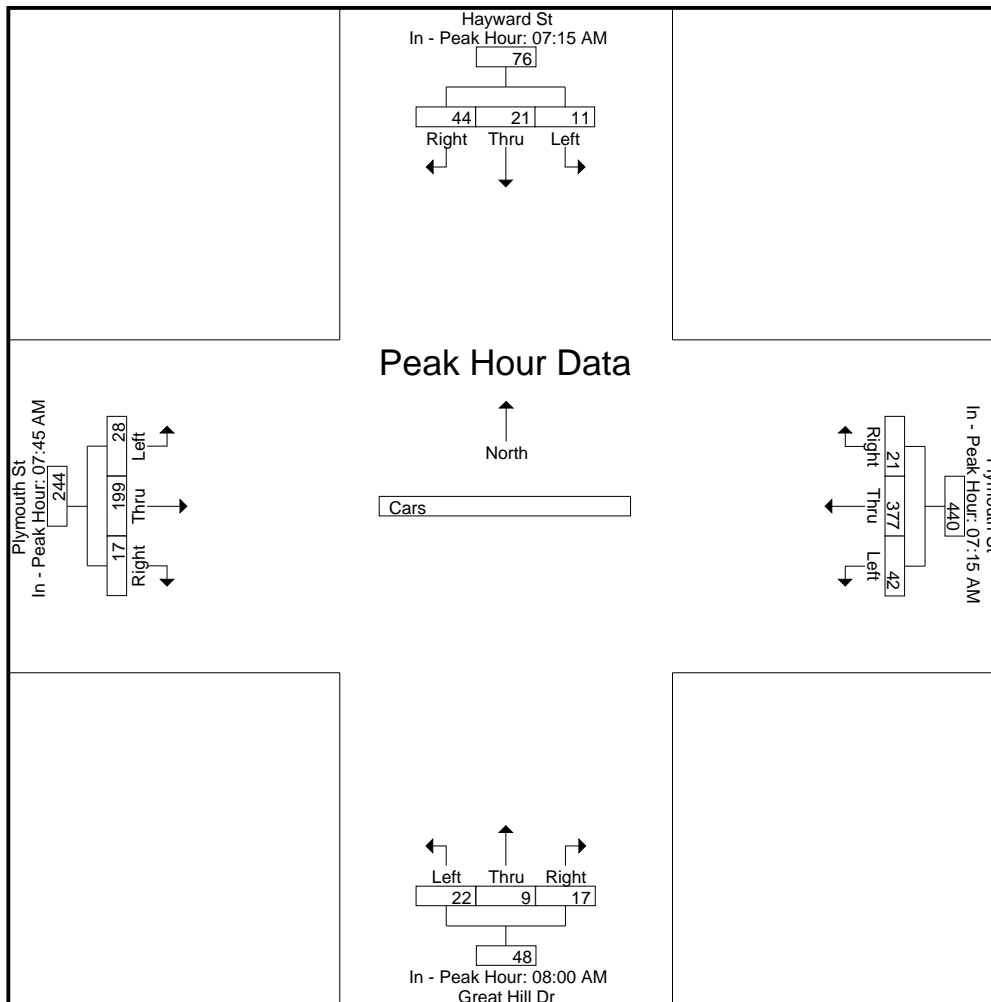

# Accurate Counts

978-664-2565

N/S Street : Hayward St / Great Hill Dr

E/W Street : Plymouth Street

City/State : Bridgewater, MA

Weather : Clear

File Name : 20270B19

Site Code : 20270019

Start Date : 10/2/2024

Page No : 7

## Groups Printed- Trucks

Start Time	Hayward St From North			Plymouth St From East			Great Hill Dr From South			Plymouth St From West			Int. Total
	Left	Thru	Right	Left	Thru	Right	Left	Thru	Right	Left	Thru	Right	
07:00 AM	0	0	1	0	6	0	0	0	0	0	4	0	11
07:15 AM	0	0	0	0	2	0	0	0	0	1	2	0	5
07:30 AM	0	0	0	0	5	0	0	0	0	0	4	1	10
07:45 AM	1	0	1	0	2	0	1	0	0	0	4	0	9
<b>Total</b>	<b>1</b>	<b>0</b>	<b>2</b>	<b>0</b>	<b>15</b>	<b>0</b>	<b>1</b>	<b>0</b>	<b>0</b>	<b>1</b>	<b>14</b>	<b>1</b>	<b>35</b>
08:00 AM	1	0	2	0	7	0	0	0	0	0	4	0	14
08:15 AM	1	0	0	0	3	1	2	0	0	0	8	1	16
08:30 AM	0	0	0	0	9	0	2	0	0	0	11	0	22
08:45 AM	1	0	2	0	6	0	1	0	0	0	4	0	14
<b>Total</b>	<b>3</b>	<b>0</b>	<b>4</b>	<b>0</b>	<b>25</b>	<b>1</b>	<b>5</b>	<b>0</b>	<b>0</b>	<b>0</b>	<b>27</b>	<b>1</b>	<b>66</b>
<b>Grand Total</b>	<b>4</b>	<b>0</b>	<b>6</b>	<b>0</b>	<b>40</b>	<b>1</b>	<b>6</b>	<b>0</b>	<b>0</b>	<b>1</b>	<b>41</b>	<b>2</b>	<b>101</b>
Apprch %	40	0	60	0	97.6	2.4	100	0	0	2.3	93.2	4.5	
Total %	4	0	5.9	0	39.6	1	5.9	0	0	1	40.6	2	

Start Time	Hayward St From North				Plymouth St From East				Great Hill Dr From South				Plymouth St From West				Int. Total
	Left	Thru	Right	App. Total	Left	Thru	Right	App. Total	Left	Thru	Right	App. Total	Left	Thru	Right	App. Total	
<b>Peak Hour Analysis From 07:00 AM to 08:45 AM - Peak 1 of 1</b>																	
<b>Peak Hour for Entire Intersection Begins at 08:00 AM</b>																	
08:00 AM	1	0	2	3	0	7	0	7	0	0	0	0	0	4	0	4	14
08:15 AM	1	0	0	1	0	3	1	4	2	0	0	2	0	8	1	9	16
08:30 AM	0	0	0	0	0	9	0	9	2	0	0	2	0	11	0	11	22
08:45 AM	1	0	2	3	0	6	0	6	1	0	0	1	0	4	0	4	14
<b>Total Volume</b>	<b>3</b>	<b>0</b>	<b>4</b>	<b>7</b>	<b>0</b>	<b>25</b>	<b>1</b>	<b>26</b>	<b>5</b>	<b>0</b>	<b>0</b>	<b>5</b>	<b>0</b>	<b>27</b>	<b>1</b>	<b>28</b>	<b>66</b>
<b>% App. Total</b>	<b>42.9</b>	<b>0</b>	<b>57.1</b>		<b>0</b>	<b>96.2</b>	<b>3.8</b>		<b>100</b>	<b>0</b>	<b>0</b>		<b>0</b>	<b>96.4</b>	<b>3.6</b>		
PHF	.750	.000	.500	.583	.000	.694	.250	.722	.625	.000	.000	.625	.000	.614	.250	.636	.750

# Accurate Counts

978-664-2565

N/S Street : Hayward St / Great Hill Dr  
 E/W Street : Plymouth Street  
 City/State : Bridgewater, MA  
 Weather : Clear

File Name : 20270B19  
 Site Code : 20270019  
 Start Date : 10/2/2024  
 Page No : 8

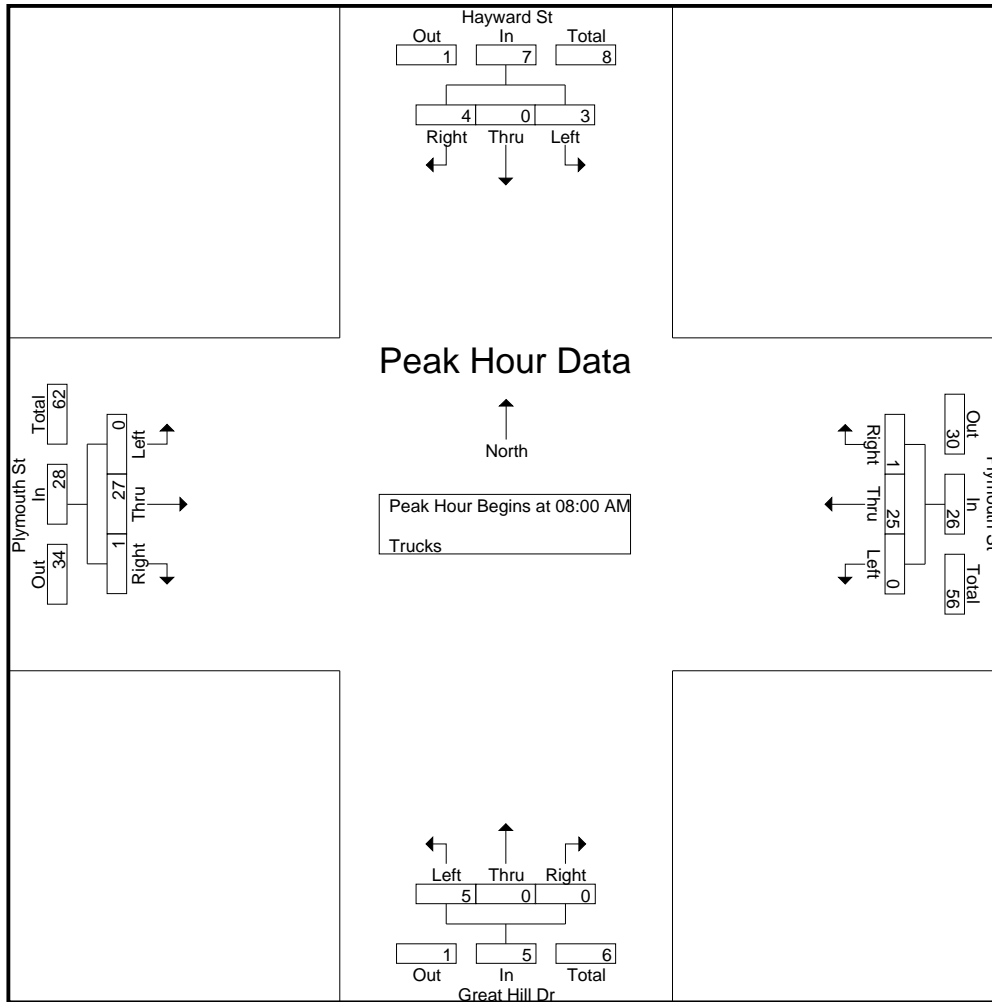

**Peak Hour Analysis From 07:00 AM to 08:45 AM - Peak 1 of 1**

**Peak Hour for Each Approach Begins at:**

	08:00 AM				08:00 AM				07:45 AM				07:45 AM			
+0 mins.	1	0	2	3	0	7	0	7	1	0	0	1	0	4	0	4
+15 mins.	1	0	0	1	0	3	1	4	0	0	0	0	0	4	0	4
+30 mins.	0	0	0	0	0	9	0	9	2	0	0	2	0	8	1	9
+45 mins.	1	0	2	3	0	6	0	6	2	0	0	2	0	11	0	11
Total Volume	3	0	4	7	0	25	1	26	5	0	0	5	0	27	1	28
% App. Total	42.9	0	57.1		0	96.2	3.8		100	0	0		0	96.4	3.6	
PHF	.750	.000	.500	.583	.000	.694	.250	.722	.625	.000	.000	.625	.000	.614	.250	.636



# Accurate Counts

978-664-2565

N/S Street : Hayward St / Great Hill Dr

E/W Street : Plymouth Street

City/State : Bridgewater, MA

Weather : Clear

File Name : 20270B19

Site Code : 20270019

Start Date : 10/2/2024

Page No : 9

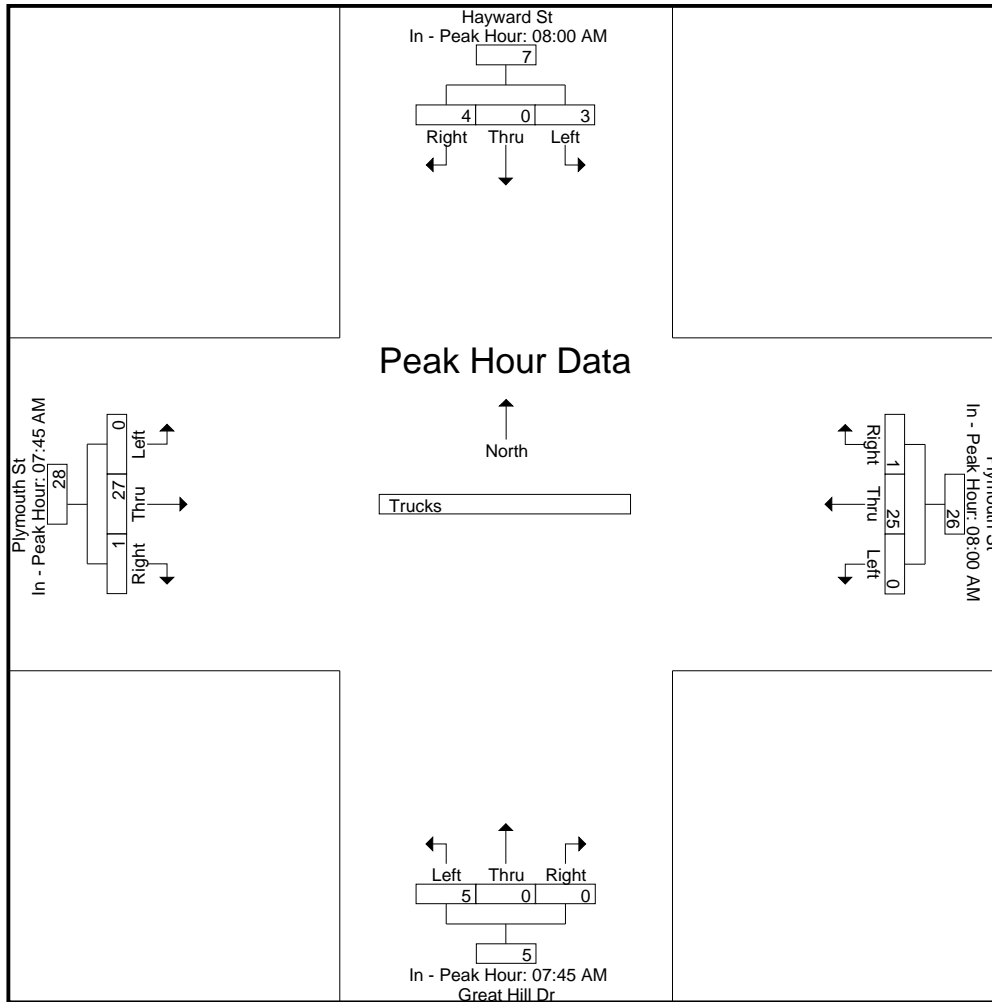

# Accurate Counts

978-664-2565

N/S Street : Hayward St / Great Hill Dr

E/W Street : Plymouth Street

City/State : Bridgewater, MA

Weather : Clear

File Name : 20270B19

Site Code : 20270019

Start Date : 10/2/2024

Page No : 10

## Groups Printed- Bikes Peds

Start Time	Hayward St From North				Plymouth St From East				Great Hill Dr From South				Plymouth St From West				Exclu. Total	Inclu. Total	Int. Total
	Left	Thru	Right	Peds	Left	Thru	Right	Peds	Left	Thru	Right	Peds	Left	Thru	Right	Peds			
07:00 AM	0	0	0	0	0	0	0	0	0	0	0	0	0	0	0	2	2	0	2
07:15 AM	0	0	0	0	0	0	0	0	0	0	0	0	0	0	0	0	0	0	0
07:30 AM	0	0	0	1	0	0	0	0	0	0	0	0	0	0	0	0	1	0	1
07:45 AM	0	0	0	0	0	1	0	0	0	0	0	0	0	0	0	0	0	1	1
<b>Total</b>	0	0	0	1	0	1	0	0	0	0	0	0	0	0	0	2	3	1	4
08:00 AM	0	0	0	0	0	0	0	0	0	0	0	0	0	0	0	0	0	0	0
08:15 AM	0	0	0	0	0	0	0	0	0	0	0	0	0	0	0	0	0	0	0
08:30 AM	0	0	0	0	0	0	0	0	0	0	0	0	0	0	0	0	0	0	0
08:45 AM	0	0	0	0	0	0	0	0	0	0	0	0	0	1	0	0	0	1	1
<b>Total</b>	0	0	0	0	0	0	0	0	0	0	0	0	0	1	0	0	0	1	1
<b>Grand Total</b>	0	0	0	1	0	1	0	0	0	0	0	0	0	1	0	2	3	2	5
Apprch %	0	0	0		0	100	0		0	0	0		0	100	0				
Total %	0	0	0		0	50	0		0	0	0		0	50	0		60	40	

Start Time	Hayward St From North				Plymouth St From East				Great Hill Dr From South				Plymouth St From West				Int. Total
	Left	Thru	Right	App. Total	Left	Thru	Right	App. Total	Left	Thru	Right	App. Total	Left	Thru	Right	App. Total	
Peak Hour Analysis From 07:00 AM to 08:45 AM - Peak 1 of 1																	
Peak Hour for Entire Intersection Begins at 07:00 AM																	
07:00 AM	0	0	0	0	0	0	0	0	0	0	0	0	0	0	0	0	0
07:15 AM	0	0	0	0	0	0	0	0	0	0	0	0	0	0	0	0	0
07:30 AM	0	0	0	0	0	0	0	0	0	0	0	0	0	0	0	0	0
07:45 AM	0	0	0	0	0	1	0	1	0	0	0	0	0	0	0	0	1
<b>Total Volume</b>	0	0	0	0	0	1	0	1	0	0	0	0	0	0	0	0	1
<b>% App. Total</b>	0	0	0		0	100	0		0	0	0		0	0	0		
PHF	.000	.000	.000	.000	.000	.250	.000	.250	.000	.000	.000	.000	.000	.000	.000	.000	.250

# Accurate Counts

978-664-2565

N/S Street : Hayward St / Great Hill Dr  
 E/W Street : Plymouth Street  
 City/State : Bridgewater, MA  
 Weather : Clear

File Name : 20270B19  
 Site Code : 20270019  
 Start Date : 10/2/2024  
 Page No : 11

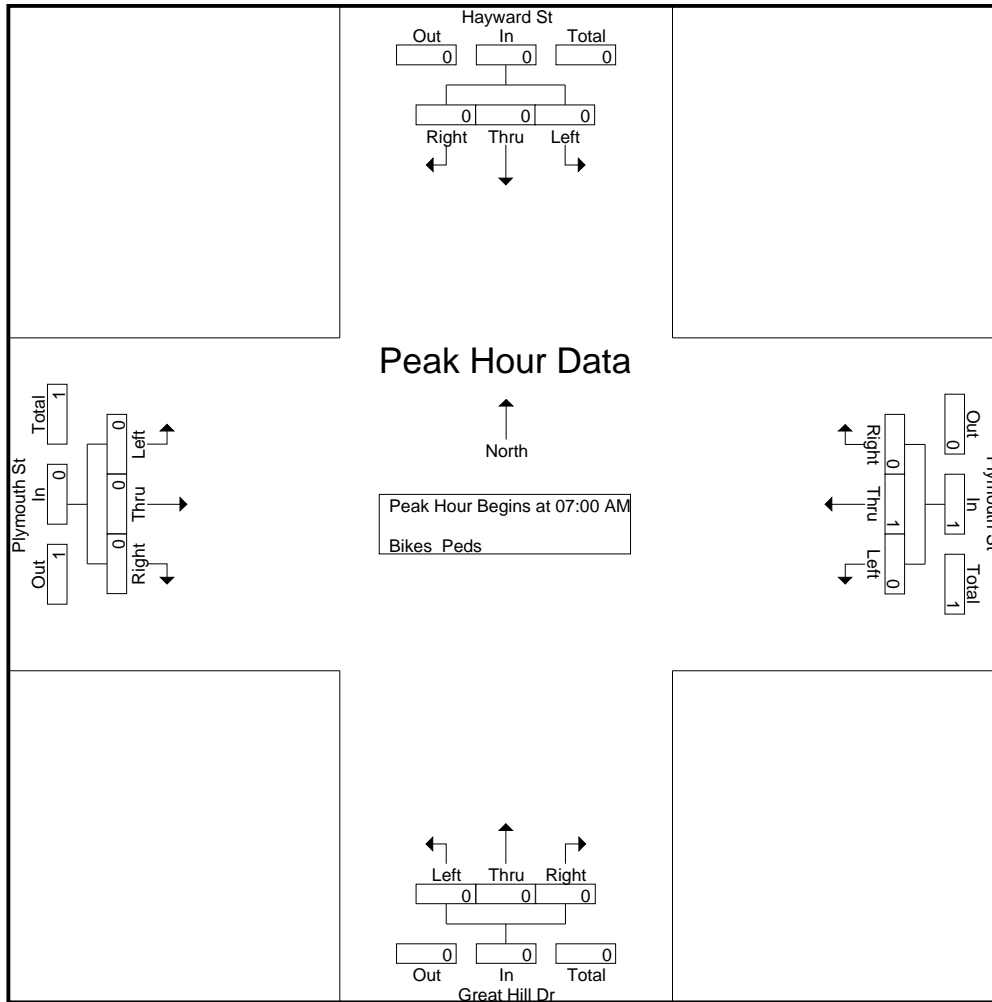

**Peak Hour Analysis From 07:00 AM to 08:45 AM - Peak 1 of 1**

**Peak Hour for Each Approach Begins at:**

	07:00 AM				07:00 AM				07:00 AM				08:00 AM			
+0 mins.	0	0	0	0	0	0	0	0	0	0	0	0	0	0	0	0
+15 mins.	0	0	0	0	0	0	0	0	0	0	0	0	0	0	0	0
+30 mins.	0	0	0	0	0	0	0	0	0	0	0	0	0	0	0	0
+45 mins.	0	0	0	0	0	1	0	1	0	0	0	0	0	1	0	1
Total Volume	0	0	0	0	0	1	0	1	0	0	0	0	0	1	0	1
% App. Total	0	0	0	0	0	100	0	0	0	0	0	0	0	100	0	0
PHF	.000	.000	.000	.000	.000	.250	.000	.250	.000	.000	.000	.000	.000	.250	.000	.250

# Accurate Counts

978-664-2565

N/S Street : Hayward St / Great Hill Dr

E/W Street : Plymouth Street

City/State : Bridgewater, MA

Weather : Clear

File Name : 20270B19

Site Code : 20270019

Start Date : 10/2/2024

Page No : 12

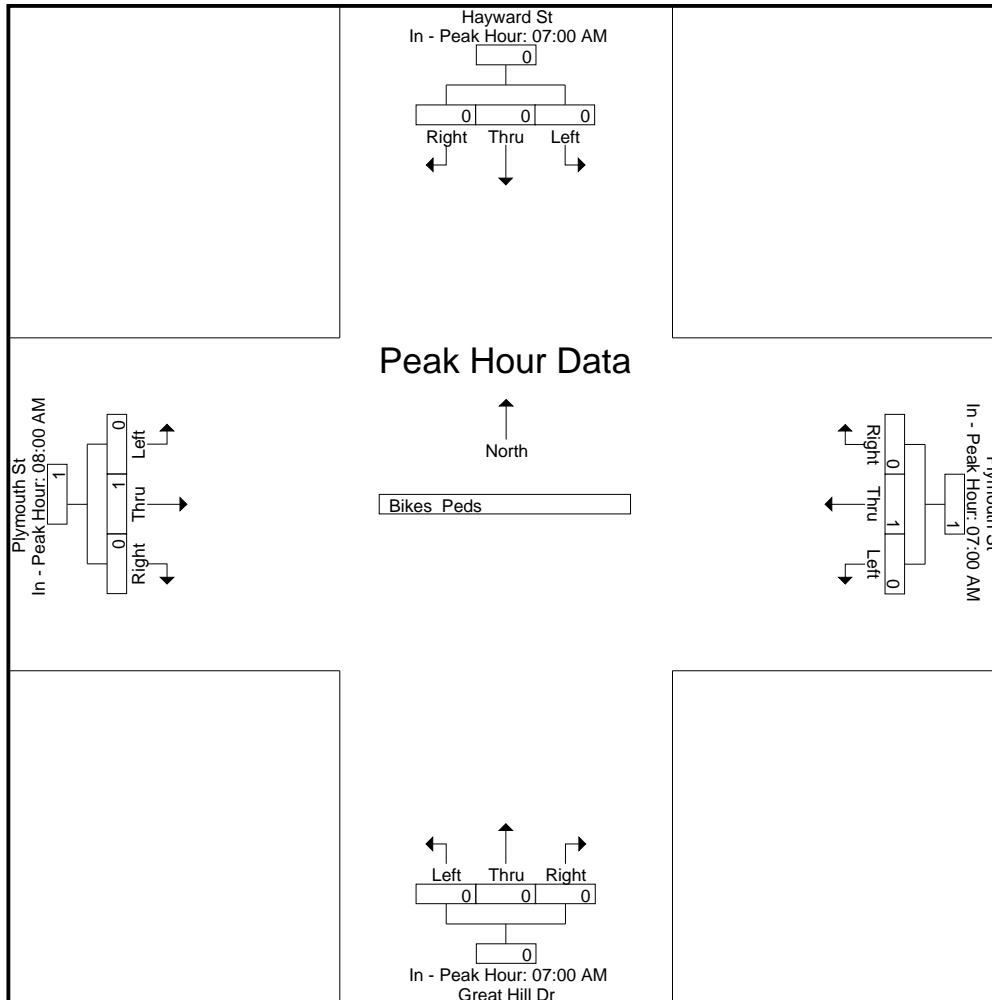

# Accurate Counts

978-664-2565

N/S Street : Hayward St / Great Hill Dr

E/W Street : Plymouth Street

City/State : Bridgewater, MA

Weather : Clear

File Name : 20270B19

Site Code : 20270019

Start Date : 10/2/2024

Page No : 1

### Groups Printed- Cars - Trucks

Start Time	Hayward St From North			Plymouth St From East			Great Hill Dr From South			Plymouth St From West			Int. Total
	Left	Thru	Right	Left	Thru	Right	Left	Thru	Right	Left	Thru	Right	
04:00 PM	7	1	8	2	74	8	18	12	30	18	88	6	272
04:15 PM	5	0	14	4	73	7	13	5	11	11	87	5	235
04:30 PM	11	2	11	3	62	3	26	5	14	21	111	5	274
04:45 PM	16	1	16	5	87	10	15	12	8	12	105	2	289
<b>Total</b>	<b>39</b>	<b>4</b>	<b>49</b>	<b>14</b>	<b>296</b>	<b>28</b>	<b>72</b>	<b>34</b>	<b>63</b>	<b>62</b>	<b>391</b>	<b>18</b>	<b>1070</b>
05:00 PM	6	7	24	4	96	4	19	5	13	12	109	4	303
05:15 PM	7	3	13	4	93	5	32	10	24	12	109	3	315
05:30 PM	6	5	10	9	84	3	9	5	4	20	86	4	245
05:45 PM	6	5	18	6	82	4	29	10	35	13	91	1	300
<b>Total</b>	<b>25</b>	<b>20</b>	<b>65</b>	<b>23</b>	<b>355</b>	<b>16</b>	<b>89</b>	<b>30</b>	<b>76</b>	<b>57</b>	<b>395</b>	<b>12</b>	<b>1163</b>
<b>Grand Total</b>	<b>64</b>	<b>24</b>	<b>114</b>	<b>37</b>	<b>651</b>	<b>44</b>	<b>161</b>	<b>64</b>	<b>139</b>	<b>119</b>	<b>786</b>	<b>30</b>	<b>2233</b>
Apprch %	31.7	11.9	56.4	5.1	88.9	6	44.2	17.6	38.2	12.7	84.1	3.2	
Total %	2.9	1.1	5.1	1.7	29.2	2	7.2	2.9	6.2	5.3	35.2	1.3	
Cars	63	24	114	36	642	44	153	64	138	118	763	29	2188
% Cars	98.4	100	100	97.3	98.6	100	95	100	99.3	99.2	97.1	96.7	98
Trucks	1	0	0	1	9	0	8	0	1	1	23	1	45
% Trucks	1.6	0	0	2.7	1.4	0	5	0	0.7	0.8	2.9	3.3	2

Start Time	Hayward St From North				Plymouth St From East				Great Hill Dr From South				Plymouth St From West				Int. Total
	Left	Thru	Right	App. Total	Left	Thru	Right	App. Total	Left	Thru	Right	App. Total	Left	Thru	Right	App. Total	
Peak Hour Analysis From 04:00 PM to 05:45 PM - Peak 1 of 1																	
Peak Hour for Entire Intersection Begins at 04:30 PM																	
04:30 PM	11	2	11	24	3	62	3	68	26	5	14	45	21	111	5	137	274
04:45 PM	16	1	16	33	5	87	10	102	15	12	8	35	12	105	2	119	289
05:00 PM	6	7	24	37	4	96	4	104	19	5	13	37	12	109	4	125	303
05:15 PM	7	3	13	23	4	93	5	102	32	10	24	66	12	109	3	124	315
<b>Total Volume</b>	<b>40</b>	<b>13</b>	<b>64</b>	<b>117</b>	<b>16</b>	<b>338</b>	<b>22</b>	<b>376</b>	<b>92</b>	<b>32</b>	<b>59</b>	<b>183</b>	<b>57</b>	<b>434</b>	<b>14</b>	<b>505</b>	<b>1181</b>
% App. Total	34.2	11.1	54.7		4.3	89.9	5.9		50.3	17.5	32.2		11.3	85.9	2.8		
PHF	.625	.464	.667	.791	.800	.880	.550	.904	.719	.667	.615	.693	.679	.977	.700	.922	.937
Cars	39	13	64	116	16	334	22	372	88	32	59	179	57	422	13	492	1159
% Cars	97.5	100	100	99.1	100	98.8	100	98.9	95.7	100	100	97.8	100	97.2	92.9	97.4	98.1
Trucks	1	0	0	1	0	4	0	4	4	0	0	4	0	12	1	13	22
% Trucks	2.5	0	0	0.9	0	1.2	0	1.1	4.3	0	0	2.2	0	2.8	7.1	2.6	1.9

# Accurate Counts

978-664-2565

N/S Street : Hayward St / Great Hill Dr  
 E/W Street : Plymouth Street  
 City/State : Bridgewater, MA  
 Weather : Clear

File Name : 20270B19  
 Site Code : 20270019  
 Start Date : 10/2/2024  
 Page No : 2

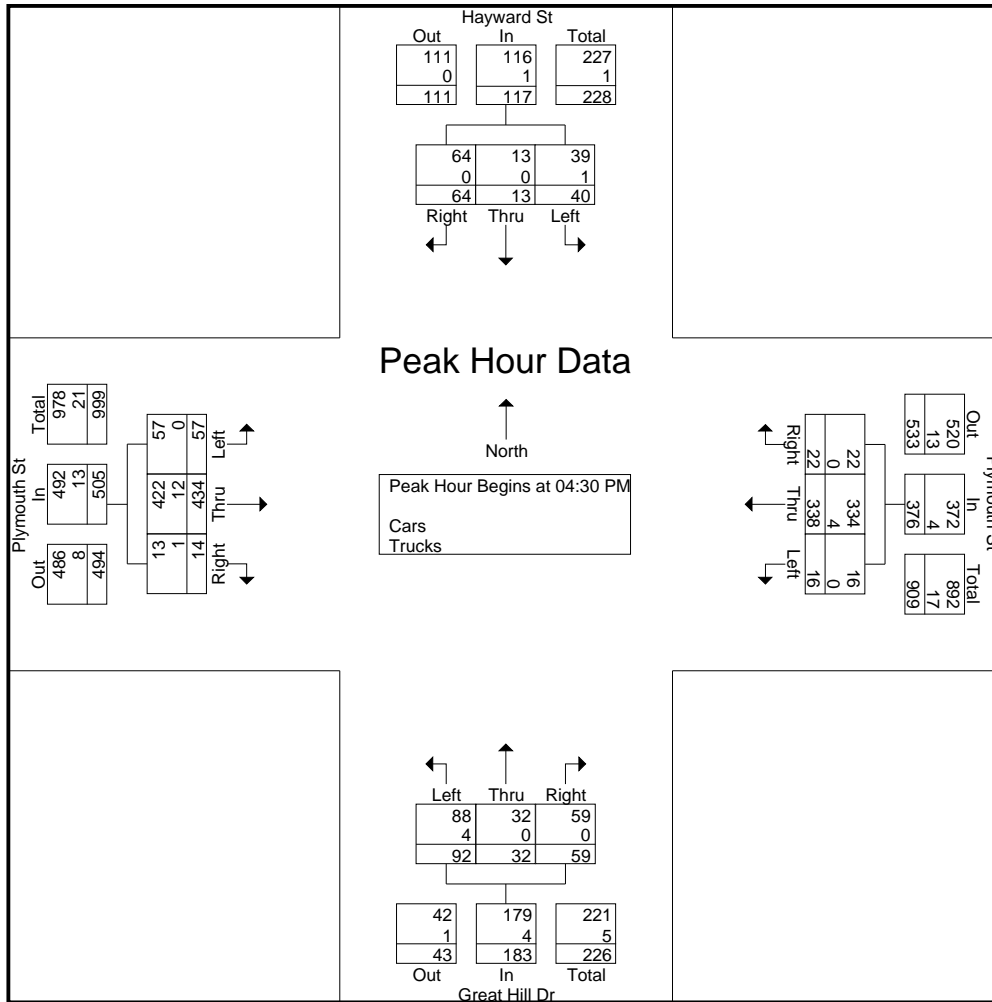

Peak Hour Analysis From 04:00 PM to 05:45 PM - Peak 1 of 1

Peak Hour for Each Approach Begins at:

	04:30 PM				04:45 PM				05:00 PM				04:30 PM			
+0 mins.	11	2	11	24	5	87	<b>10</b>	102	19	5	13	37	<b>21</b>	<b>111</b>	<b>5</b>	<b>137</b>
+15 mins.	<b>16</b>	1	16	33	4	<b>96</b>	4	<b>104</b>	<b>32</b>	<b>10</b>	24	66	12	105	2	119
+30 mins.	6	<b>7</b>	<b>24</b>	<b>37</b>	4	93	5	102	9	5	4	18	12	109	4	125
+45 mins.	7	3	13	23	<b>9</b>	84	3	96	29	10	<b>35</b>	<b>74</b>	12	109	3	124
Total Volume	40	13	64	117	22	360	22	404	89	30	76	195	57	434	14	505
% App. Total	34.2	11.1	54.7		5.4	89.1	5.4		45.6	15.4	39		11.3	85.9	2.8	
PHF	.625	.464	.667	.791	.611	.938	.550	.971	.695	.750	.543	.659	.679	.977	.700	.922
Cars	39	13	64	116	22	357	22	401	87	30	76	193	57	422	13	492
% Cars	97.5	100	100	99.1	100	99.2	100	99.3	97.8	100	100	99	100	97.2	92.9	97.4
Trucks	1	0	0	1	0	3	0	3	2	0	0	2	0	12	1	13
% Trucks	2.5	0	0	0.9	0	0.8	0	0.7	2.2	0	0	1	0	2.8	7.1	2.6

# Accurate Counts

978-664-2565

File Name : 20270B19

Site Code : 20270019

Start Date : 10/2/2024

Page No : 3

N/S Street : Hayward St / Great Hill Dr

E/W Street : Plymouth Street

City/State : Bridgewater, MA

Weather : Clear

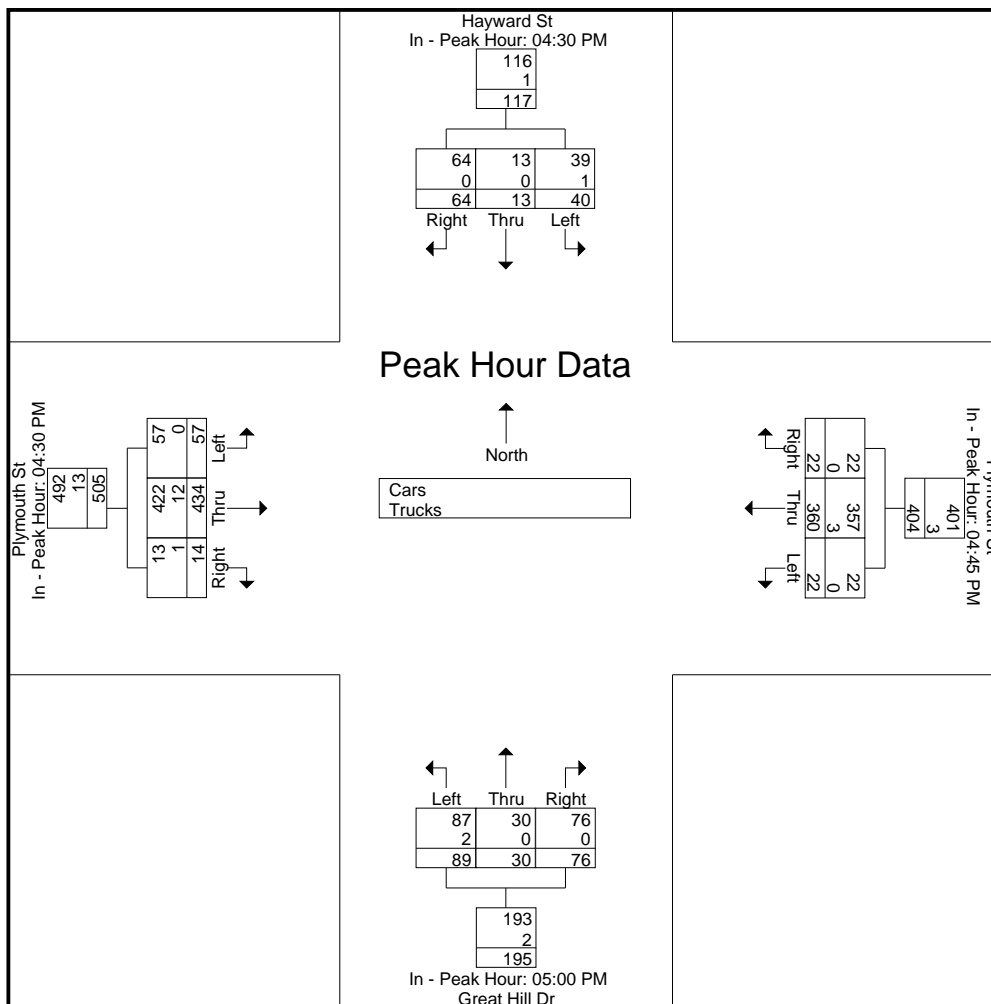

# Accurate Counts

978-664-2565

N/S Street : Hayward St / Great Hill Dr  
 E/W Street : Plymouth Street  
 City/State : Bridgewater, MA  
 Weather : Clear

File Name : 20270B19  
 Site Code : 20270019  
 Start Date : 10/2/2024  
 Page No : 4

## Groups Printed- Cars

Start Time	Hayward St From North			Plymouth St From East			Great Hill Dr From South			Plymouth St From West			Int. Total
	Left	Thru	Right	Left	Thru	Right	Left	Thru	Right	Left	Thru	Right	
04:00 PM	7	1	8	2	74	8	17	12	30	17	82	6	264
04:15 PM	5	0	14	3	68	7	10	5	10	11	83	5	221
04:30 PM	10	2	11	3	61	3	25	5	14	21	108	5	268
04:45 PM	16	1	16	5	85	10	14	12	8	12	100	2	281
<b>Total</b>	<b>38</b>	<b>4</b>	<b>49</b>	<b>13</b>	<b>288</b>	<b>28</b>	<b>66</b>	<b>34</b>	<b>62</b>	<b>61</b>	<b>373</b>	<b>18</b>	<b>1034</b>
05:00 PM	6	7	24	4	95	4	19	5	13	12	109	3	301
05:15 PM	7	3	13	4	93	5	30	10	24	12	105	3	309
05:30 PM	6	5	10	9	84	3	9	5	4	20	86	4	245
05:45 PM	6	5	18	6	82	4	29	10	35	13	90	1	299
<b>Total</b>	<b>25</b>	<b>20</b>	<b>65</b>	<b>23</b>	<b>354</b>	<b>16</b>	<b>87</b>	<b>30</b>	<b>76</b>	<b>57</b>	<b>390</b>	<b>11</b>	<b>1154</b>
<b>Grand Total</b>	<b>63</b>	<b>24</b>	<b>114</b>	<b>36</b>	<b>642</b>	<b>44</b>	<b>153</b>	<b>64</b>	<b>138</b>	<b>118</b>	<b>763</b>	<b>29</b>	<b>2188</b>
Apprch %	31.3	11.9	56.7	5	88.9	6.1	43.1	18	38.9	13	83.8	3.2	
Total %	2.9	1.1	5.2	1.6	29.3	2	7	2.9	6.3	5.4	34.9	1.3	

Start Time	Hayward St From North				Plymouth St From East				Great Hill Dr From South				Plymouth St From West				Int. Total
	Left	Thru	Right	App. Total	Left	Thru	Right	App. Total	Left	Thru	Right	App. Total	Left	Thru	Right	App. Total	
<b>Peak Hour Analysis From 04:00 PM to 05:45 PM - Peak 1 of 1</b>																	
<b>Peak Hour for Entire Intersection Begins at 04:30 PM</b>																	
04:30 PM	10	2	11	23	3	61	3	67	25	5	14	44	<b>21</b>	108	<b>5</b>	<b>134</b>	268
04:45 PM	<b>16</b>	1	16	33	<b>5</b>	85	<b>10</b>	100	14	<b>12</b>	8	34	12	100	2	114	281
05:00 PM	6	<b>7</b>	<b>24</b>	<b>37</b>	4	<b>95</b>	4	<b>103</b>	19	5	13	37	12	<b>109</b>	3	124	301
05:15 PM	7	3	13	23	4	93	5	102	<b>30</b>	10	<b>24</b>	<b>64</b>	12	105	3	120	<b>309</b>
Total Volume	39	13	64	116	16	334	22	372	88	32	59	179	57	422	13	492	1159
% App. Total	33.6	11.2	55.2		4.3	89.8	5.9		49.2	17.9	33		11.6	85.8	2.6		
PHF	.609	.464	.667	.784	.800	.879	.550	.903	.733	.667	.615	.699	.679	.968	.650	.918	.938



# Accurate Counts

978-664-2565

N/S Street : Hayward St / Great Hill Dr  
 E/W Street : Plymouth Street  
 City/State : Bridgewater, MA  
 Weather : Clear

File Name : 20270B19  
 Site Code : 20270019  
 Start Date : 10/2/2024  
 Page No : 5

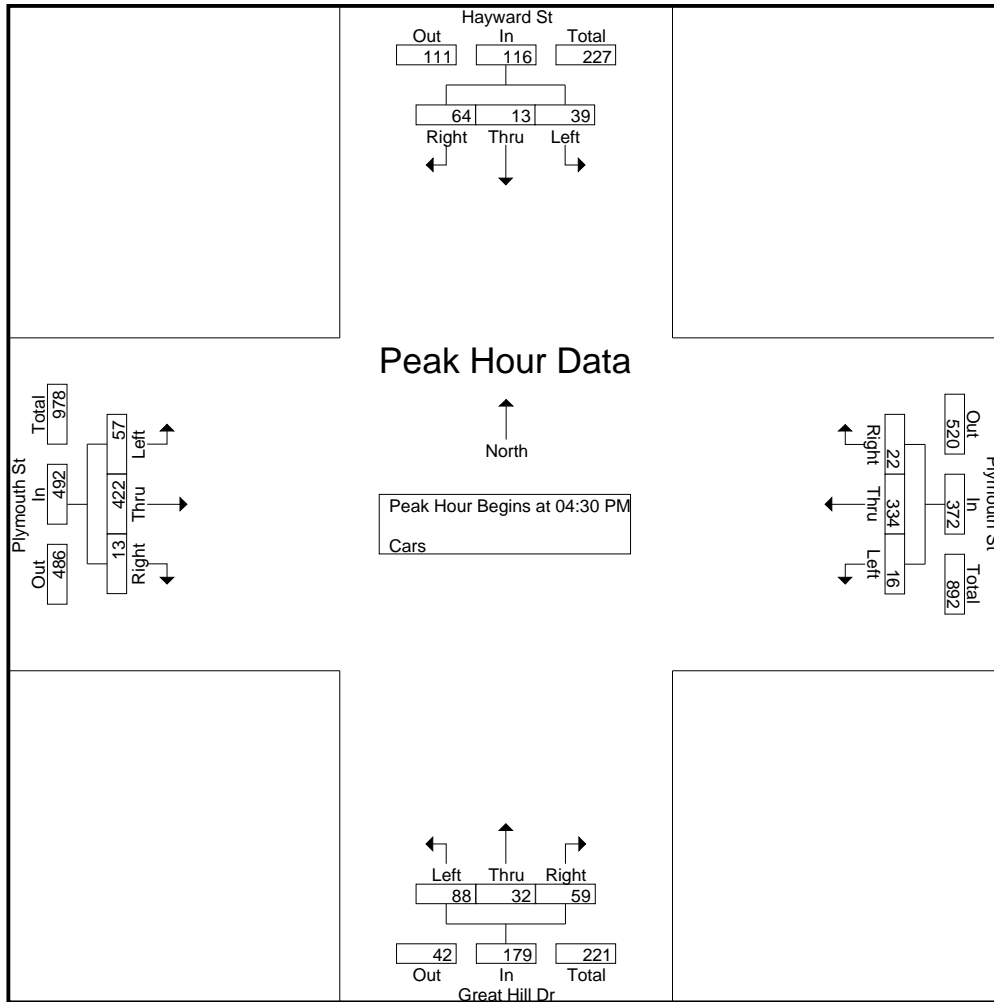

**Peak Hour Analysis From 04:00 PM to 05:45 PM - Peak 1 of 1**

**Peak Hour for Each Approach Begins at:**

	04:30 PM				04:45 PM				05:00 PM				04:30 PM			
+0 mins.	10	2	11	23	5	85	<b>10</b>	100	19	5	13	37	<b>21</b>	108	<b>5</b>	<b>134</b>
+15 mins.	<b>16</b>	1	16	33	4	<b>95</b>	4	<b>103</b>	<b>30</b>	<b>10</b>	24	64	12	100	2	114
+30 mins.	6	<b>7</b>	<b>24</b>	<b>37</b>	4	93	5	102	9	5	4	18	12	<b>109</b>	3	124
+45 mins.	7	3	13	23	<b>9</b>	84	3	96	29	10	<b>35</b>	<b>74</b>	12	105	3	120
Total Volume	39	13	64	116	22	357	22	401	87	30	76	193	57	422	13	492
% App. Total	33.6	11.2	55.2		5.5	89	5.5		45.1	15.5	39.4		11.6	85.8	2.6	
PHF	.609	.464	.667	.784	.611	.939	.550	.973	.725	.750	.543	.652	.679	.968	.650	.918

# Accurate Counts

978-664-2565

File Name : 20270B19

Site Code : 20270019

Start Date : 10/2/2024

Page No : 6

N/S Street : Hayward St / Great Hill Dr

E/W Street : Plymouth Street

City/State : Bridgewater, MA

Weather : Clear

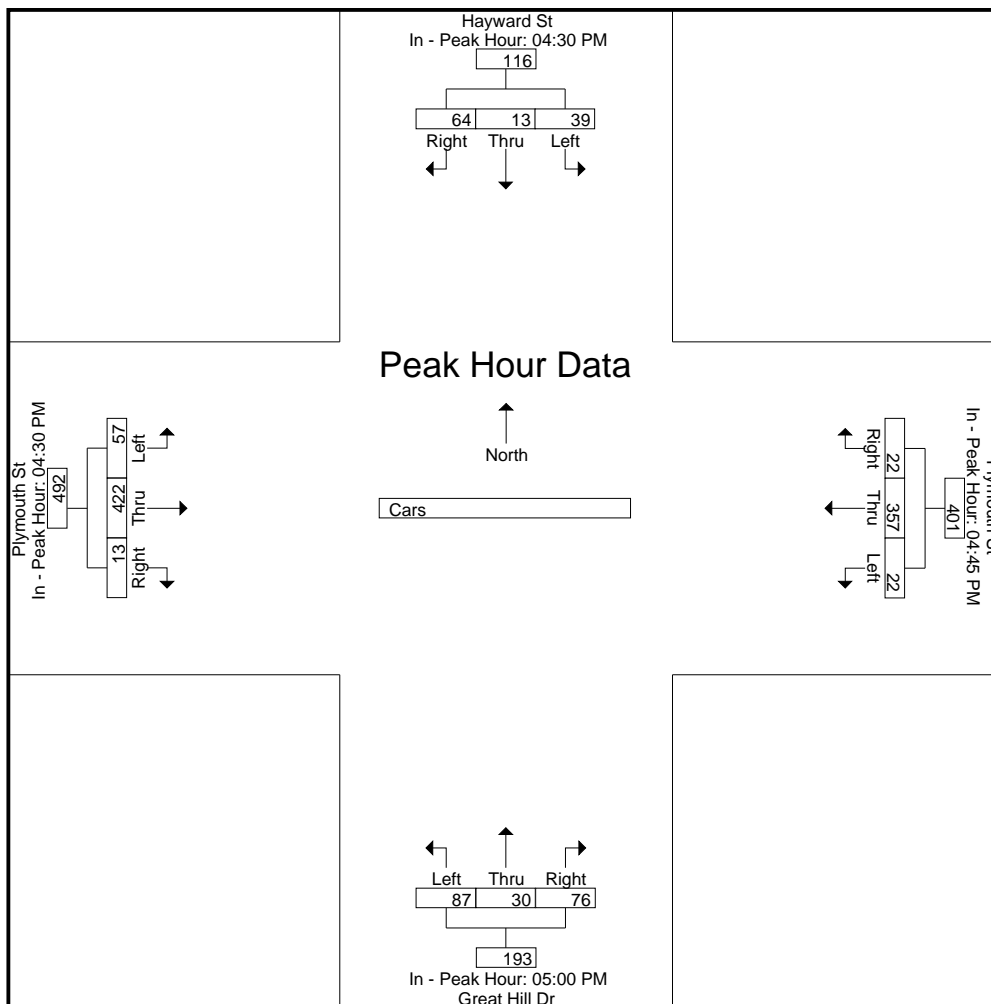

# Accurate Counts

978-664-2565

N/S Street : Hayward St / Great Hill Dr  
 E/W Street : Plymouth Street  
 City/State : Bridgewater, MA  
 Weather : Clear

File Name : 20270B19  
 Site Code : 20270019  
 Start Date : 10/2/2024  
 Page No : 7

### Groups Printed- Trucks

Start Time	Hayward St From North			Plymouth St From East			Great Hill Dr From South			Plymouth St From West			Int. Total
	Left	Thru	Right	Left	Thru	Right	Left	Thru	Right	Left	Thru	Right	
04:00 PM	0	0	0	0	0	0	1	0	0	1	6	0	8
04:15 PM	0	0	0	1	5	0	3	0	1	0	4	0	14
04:30 PM	1	0	0	0	1	0	1	0	0	0	3	0	6
04:45 PM	0	0	0	0	2	0	1	0	0	0	5	0	8
<b>Total</b>	<b>1</b>	<b>0</b>	<b>0</b>	<b>1</b>	<b>8</b>	<b>0</b>	<b>6</b>	<b>0</b>	<b>1</b>	<b>1</b>	<b>18</b>	<b>0</b>	<b>36</b>
05:00 PM	0	0	0	0	1	0	0	0	0	0	0	1	2
05:15 PM	0	0	0	0	0	0	2	0	0	0	4	0	6
05:30 PM	0	0	0	0	0	0	0	0	0	0	0	0	0
05:45 PM	0	0	0	0	0	0	0	0	0	0	1	0	1
<b>Total</b>	<b>0</b>	<b>0</b>	<b>0</b>	<b>0</b>	<b>1</b>	<b>0</b>	<b>2</b>	<b>0</b>	<b>0</b>	<b>0</b>	<b>5</b>	<b>1</b>	<b>9</b>
<b>Grand Total</b>	<b>1</b>	<b>0</b>	<b>0</b>	<b>1</b>	<b>9</b>	<b>0</b>	<b>8</b>	<b>0</b>	<b>1</b>	<b>1</b>	<b>23</b>	<b>1</b>	<b>45</b>
Apprch %	100	0	0	10	90	0	88.9	0	11.1	4	92	4	
Total %	2.2	0	0	2.2	20	0	17.8	0	2.2	2.2	51.1	2.2	

Start Time	Hayward St From North				Plymouth St From East				Great Hill Dr From South				Plymouth St From West				Int. Total
	Left	Thru	Right	App. Total	Left	Thru	Right	App. Total	Left	Thru	Right	App. Total	Left	Thru	Right	App. Total	
<b>Peak Hour Analysis From 04:00 PM to 05:45 PM - Peak 1 of 1</b>																	
<b>Peak Hour for Entire Intersection Begins at 04:00 PM</b>																	
04:00 PM	0	0	0	0	0	0	0	0	1	0	0	1	1	6	0	7	8
04:15 PM	0	0	0	0	1	5	0	6	3	0	1	4	0	4	0	4	14
04:30 PM	1	0	0	1	0	1	0	1	1	0	0	1	0	3	0	3	6
04:45 PM	0	0	0	0	0	2	0	2	1	0	0	1	0	5	0	5	8
<b>Total Volume</b>	<b>1</b>	<b>0</b>	<b>0</b>	<b>1</b>	<b>1</b>	<b>8</b>	<b>0</b>	<b>9</b>	<b>6</b>	<b>0</b>	<b>1</b>	<b>7</b>	<b>1</b>	<b>18</b>	<b>0</b>	<b>19</b>	<b>36</b>
<b>% App. Total</b>	<b>100</b>	<b>0</b>	<b>0</b>		<b>11.1</b>	<b>88.9</b>	<b>0</b>		<b>85.7</b>	<b>0</b>	<b>14.3</b>		<b>5.3</b>	<b>94.7</b>	<b>0</b>		
PHF	.250	.000	.000	.250	.250	.400	.000	.375	.500	.000	.250	.438	.250	.750	.000	.679	.643

# Accurate Counts

978-664-2565

N/S Street : Hayward St / Great Hill Dr  
 E/W Street : Plymouth Street  
 City/State : Bridgewater, MA  
 Weather : Clear

File Name : 20270B19  
 Site Code : 20270019  
 Start Date : 10/2/2024  
 Page No : 8

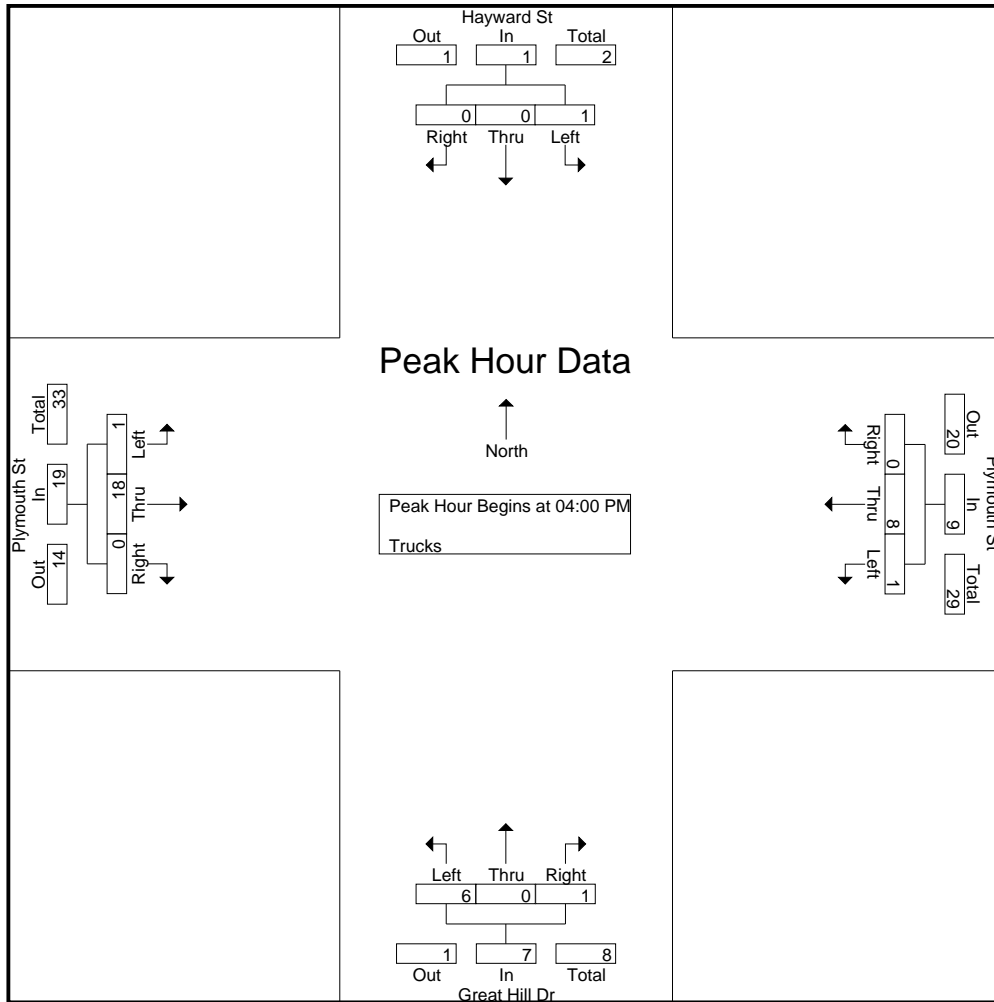

**Peak Hour Analysis From 04:00 PM to 05:45 PM - Peak 1 of 1**

Peak Hour for Each Approach Begins at:

	04:00 PM				04:15 PM				04:00 PM				04:00 PM			
+0 mins.	0	0	0	0	1	5	0	6	1	0	0	1	1	6	0	7
+15 mins.	0	0	0	0	0	1	0	1	3	0	1	4	0	4	0	4
+30 mins.	1	0	0	1	0	2	0	2	1	0	0	1	0	3	0	3
+45 mins.	0	0	0	0	0	1	0	1	1	0	0	1	0	5	0	5
Total Volume	1	0	0	1	1	9	0	10	6	0	1	7	1	18	0	19
% App. Total	100	0	0		10	90	0		85.7	0	14.3		5.3	94.7	0	
PHF	.250	.000	.000	.250	.250	.450	.000	.417	.500	.000	.250	.438	.250	.750	.000	.679

# Accurate Counts

978-664-2565

File Name : 20270B19

Site Code : 20270019

Start Date : 10/2/2024

Page No : 9

N/S Street : Hayward St / Great Hill Dr

E/W Street : Plymouth Street

City/State : Bridgewater, MA

Weather : Clear

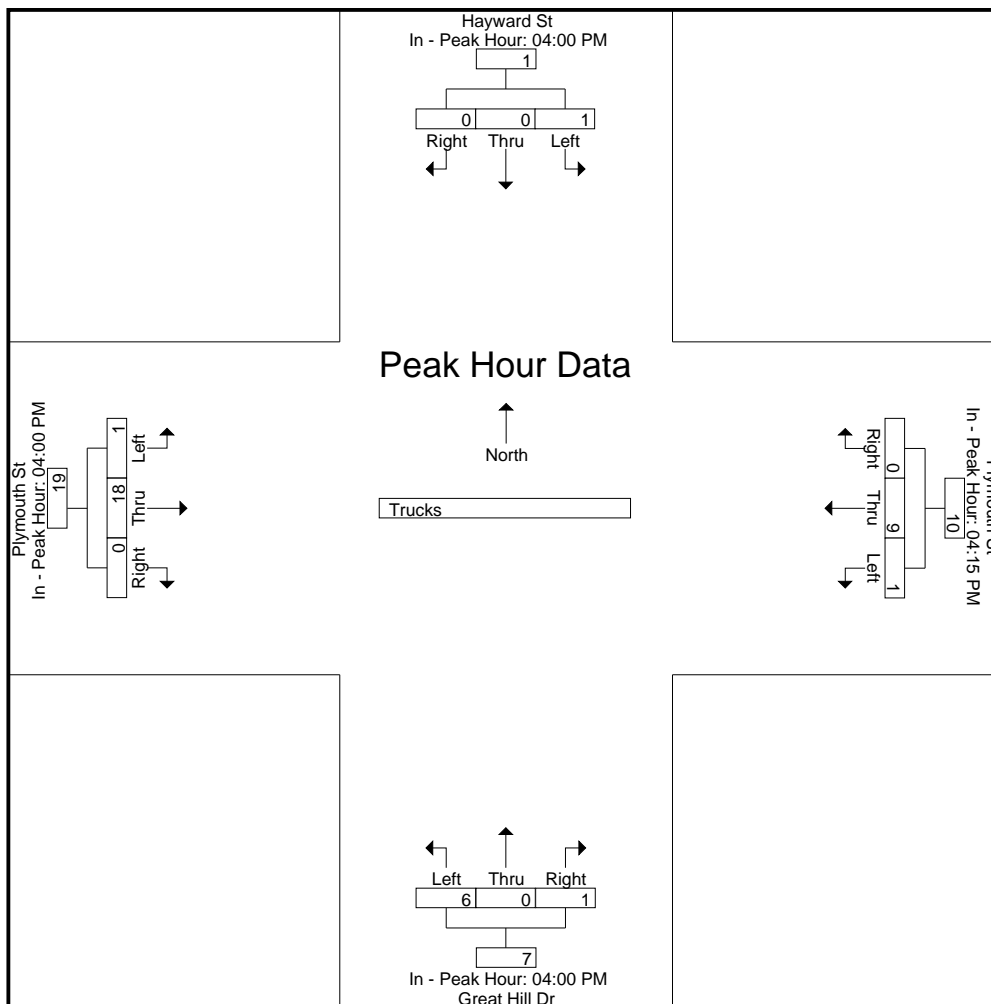

# Accurate Counts

978-664-2565

N/S Street : Hayward St / Great Hill Dr

E/W Street : Plymouth Street

City/State : Bridgewater, MA

Weather : Clear

File Name : 20270B19

Site Code : 20270019

Start Date : 10/2/2024

Page No : 10

## Groups Printed- Bikes Peds

Start Time	Hayward St From North				Plymouth St From East				Great Hill Dr From South				Plymouth St From West				Exclu. Total	Inclu. Total	Int. Total
	Left	Thru	Right	Peds	Left	Thru	Right	Peds	Left	Thru	Right	Peds	Left	Thru	Right	Peds			
04:00 PM	0	0	0	0	0	0	0	0	0	0	0	0	0	0	0	2	2	0	2
04:15 PM	0	0	0	0	0	0	0	0	0	0	0	0	0	0	0	1	1	0	1
04:30 PM	0	0	0	0	0	0	0	1	0	0	0	0	0	0	0	0	1	0	1
04:45 PM	0	0	0	0	0	0	0	0	0	0	0	0	0	0	0	0	0	0	0
<b>Total</b>	0	0	0	0	0	0	0	1	0	0	0	0	0	0	0	3	4	0	4
05:00 PM	0	0	0	0	0	0	0	0	0	0	0	0	0	0	0	0	0	0	0
05:15 PM	0	0	0	0	0	0	0	0	0	0	0	0	0	0	0	0	0	0	0
05:30 PM	0	0	0	0	0	0	0	0	0	0	0	0	0	0	0	0	0	0	0
05:45 PM	0	0	0	0	0	0	0	0	0	0	0	0	0	0	0	0	0	0	0
<b>Total</b>	0	0	0	0	0	0	0	0	0	0	0	0	0	0	0	0	0	0	0
<b>Grand Total</b>	0	0	0	0	0	0	0	1	0	0	0	0	0	0	0	3	4	0	4
Apprch %	0	0	0		0	0	0		0	0	0		0	0	0				
Total %																	100	0	

Start Time	Hayward St From North				Plymouth St From East				Great Hill Dr From South				Plymouth St From West				Int. Total
	Left	Thru	Right	App. Total	Left	Thru	Right	App. Total	Left	Thru	Right	App. Total	Left	Thru	Right	App. Total	
<b>Peak Hour Analysis From 04:00 PM to 05:45 PM - Peak 1 of 1</b>																	
<b>Peak Hour for Entire Intersection Begins at 04:00 PM</b>																	
04:00 PM	0	0	0	0	0	0	0	0	0	0	0	0	0	0	0	0	0
04:15 PM	0	0	0	0	0	0	0	0	0	0	0	0	0	0	0	0	0
04:30 PM	0	0	0	0	0	0	0	0	0	0	0	0	0	0	0	0	0
04:45 PM	0	0	0	0	0	0	0	0	0	0	0	0	0	0	0	0	0
<b>Total Volume</b>	0	0	0	0	0	0	0	0	0	0	0	0	0	0	0	0	0
<b>% App. Total</b>	0	0	0		0	0	0		0	0	0		0	0	0		
PHF	.000	.000	.000	.000	.000	.000	.000	.000	.000	.000	.000	.000	.000	.000	.000	.000	.000

# Accurate Counts

978-664-2565

N/S Street : Hayward St / Great Hill Dr

E/W Street : Plymouth Street

City/State : Bridgewater, MA

Weather : Clear

File Name : 20270B19

Site Code : 20270019

Start Date : 10/2/2024

Page No : 11

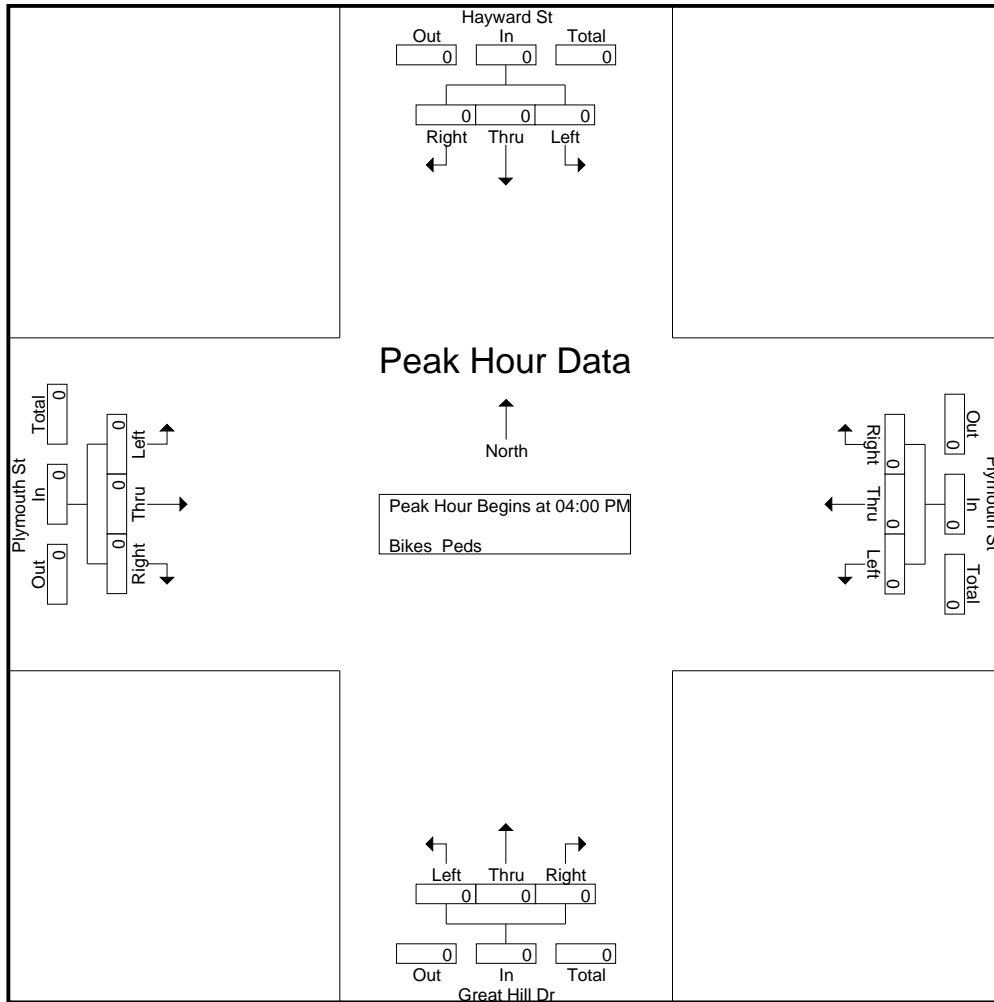

**Peak Hour Analysis From 04:00 PM to 05:45 PM - Peak 1 of 1**

**Peak Hour for Each Approach Begins at:**

	04:00 PM				04:00 PM				04:00 PM				04:00 PM			
+0 mins.	0	0	0	0	0	0	0	0	0	0	0	0	0	0	0	0
+15 mins.	0	0	0	0	0	0	0	0	0	0	0	0	0	0	0	0
+30 mins.	0	0	0	0	0	0	0	0	0	0	0	0	0	0	0	0
+45 mins.	0	0	0	0	0	0	0	0	0	0	0	0	0	0	0	0
Total Volume	0	0	0	0	0	0	0	0	0	0	0	0	0	0	0	0
% App. Total	0	0	0	0	0	0	0	0	0	0	0	0	0	0	0	0
PHF	.000	.000	.000	.000	.000	.000	.000	.000	.000	.000	.000	.000	.000	.000	.000	.000

# Accurate Counts

978-664-2565

N/S Street : Hayward St / Great Hill Dr

E/W Street : Plymouth Street

City/State : Bridgewater, MA

Weather : Clear

File Name : 20270B19

Site Code : 20270019

Start Date : 10/2/2024

Page No : 12

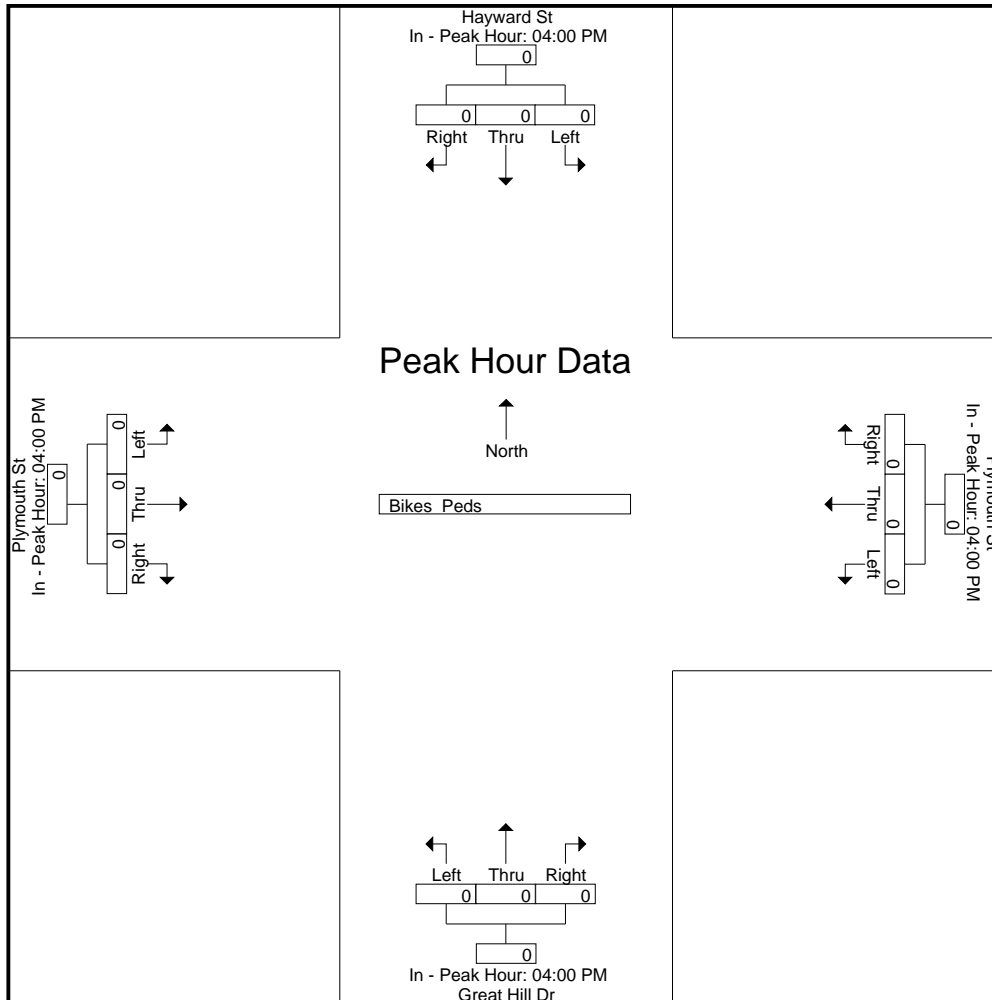



# Accurate Counts

978-664-2565

N/S Street : Route 24 SB Ramps  
 E/W Street : Route 104  
 City/State : Bridgewater, MA  
 Weather : Clear

File Name : 202700B1  
 Site Code : 20270001  
 Start Date : 10/2/2024  
 Page No : 1

### Groups Printed- Cars - Trucks

Start Time	Route 24 SB Ramps From North		Route 104 From East		Route 104 From West		Int. Total
	Left	Right	Thru	Right	Left	Thru	
07:00 AM	22	22	52	183	19	173	471
07:15 AM	32	27	74	208	20	133	494
07:30 AM	46	27	59	213	17	169	531
07:45 AM	51	26	64	182	16	151	490
<b>Total</b>	<b>151</b>	<b>102</b>	<b>249</b>	<b>786</b>	<b>72</b>	<b>626</b>	<b>1986</b>
08:00 AM	40	25	65	166	18	145	459
08:15 AM	46	39	91	173	20	127	496
08:30 AM	36	27	63	149	20	132	427
08:45 AM	34	26	66	113	8	109	356
<b>Total</b>	<b>156</b>	<b>117</b>	<b>285</b>	<b>601</b>	<b>66</b>	<b>513</b>	<b>1738</b>
<b>Grand Total</b>	<b>307</b>	<b>219</b>	<b>534</b>	<b>1387</b>	<b>138</b>	<b>1139</b>	<b>3724</b>
Apprch %	58.4	41.6	27.8	72.2	10.8	89.2	
Total %	8.2	5.9	14.3	37.2	3.7	30.6	
Cars	289	202	511	1288	129	1106	3525
% Cars	94.1	92.2	95.7	92.9	93.5	97.1	94.7
Trucks	18	17	23	99	9	33	199
% Trucks	5.9	7.8	4.3	7.1	6.5	2.9	5.3

Start Time	Route 24 SB Ramps From North			Route 104 From East			Route 104 From West			Int. Total
	Left	Right	App. Total	Thru	Right	App. Total	Left	Thru	App. Total	
Peak Hour Analysis From 07:00 AM to 08:45 AM - Peak 1 of 1										
Peak Hour for Entire Intersection Begins at 07:00 AM										
07:00 AM	22	22	44	52	183	235	19	<b>173</b>	<b>192</b>	471
07:15 AM	32	<b>27</b>	59	<b>74</b>	208	<b>282</b>	<b>20</b>	133	153	494
07:30 AM	46	27	73	59	<b>213</b>	272	17	169	186	<b>531</b>
07:45 AM	<b>51</b>	26	<b>77</b>	64	182	246	16	151	167	490
<b>Total Volume</b>	151	102	253	249	786	1035	72	626	698	1986
% App. Total	59.7	40.3		24.1	75.9		10.3	89.7		
PHF	.740	.944	.821	.841	.923	.918	.900	.905	.909	.935
Cars	145	90	235	234	737	971	69	607	676	1882
% Cars	96.0	88.2	92.9	94.0	93.8	93.8	95.8	97.0	96.8	94.8
Trucks	6	12	18	15	49	64	3	19	22	104
% Trucks	4.0	11.8	7.1	6.0	6.2	6.2	4.2	3.0	3.2	5.2

# Accurate Counts

978-664-2565

N/S Street : Route 24 SB Ramps  
 E/W Street : Route 104  
 City/State : Bridgewater, MA  
 Weather : Clear

File Name : 202700B1  
 Site Code : 20270001  
 Start Date : 10/2/2024  
 Page No : 2

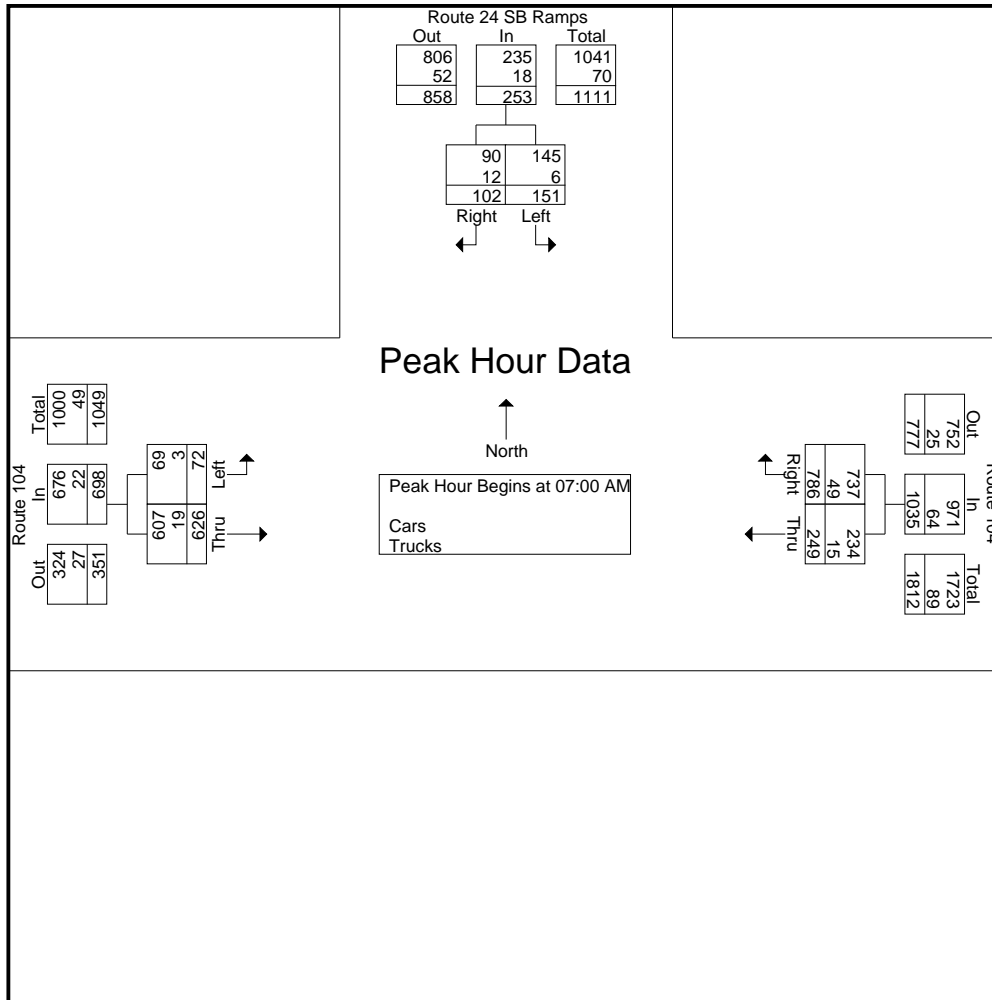

**Peak Hour Analysis From 07:00 AM to 08:45 AM - Peak 1 of 1**

Peak Hour for Each Approach Begins at:

	07:30 AM			07:00 AM			07:00 AM		
+0 mins.	46	27	73	52	183	235	19	173	192
+15 mins.	51	26	77	74	208	282	20	133	153
+30 mins.	40	25	65	59	213	272	17	169	186
+45 mins.	46	39	85	64	182	246	16	151	167
Total Volume	183	117	300	249	786	1035	72	626	698
% App. Total	61	39		24.1	75.9		10.3	89.7	
PHF	.897	.750	.882	.841	.923	.918	.900	.905	.909
Cars	176	109	285	234	737	971	69	607	676
% Cars	96.2	93.2	95	94	93.8	93.8	95.8	97	96.8
Trucks	7	8	15	15	49	64	3	19	22
% Trucks	3.8	6.8	5	6	6.2	6.2	4.2	3	3.2

# Accurate Counts

978-664-2565

File Name : 202700B1

Site Code : 20270001

Start Date : 10/2/2024

Page No : 3

N/S Street : Route 24 SB Ramps

E/W Street : Route 104

City/State : Bridgewater, MA

Weather : Clear

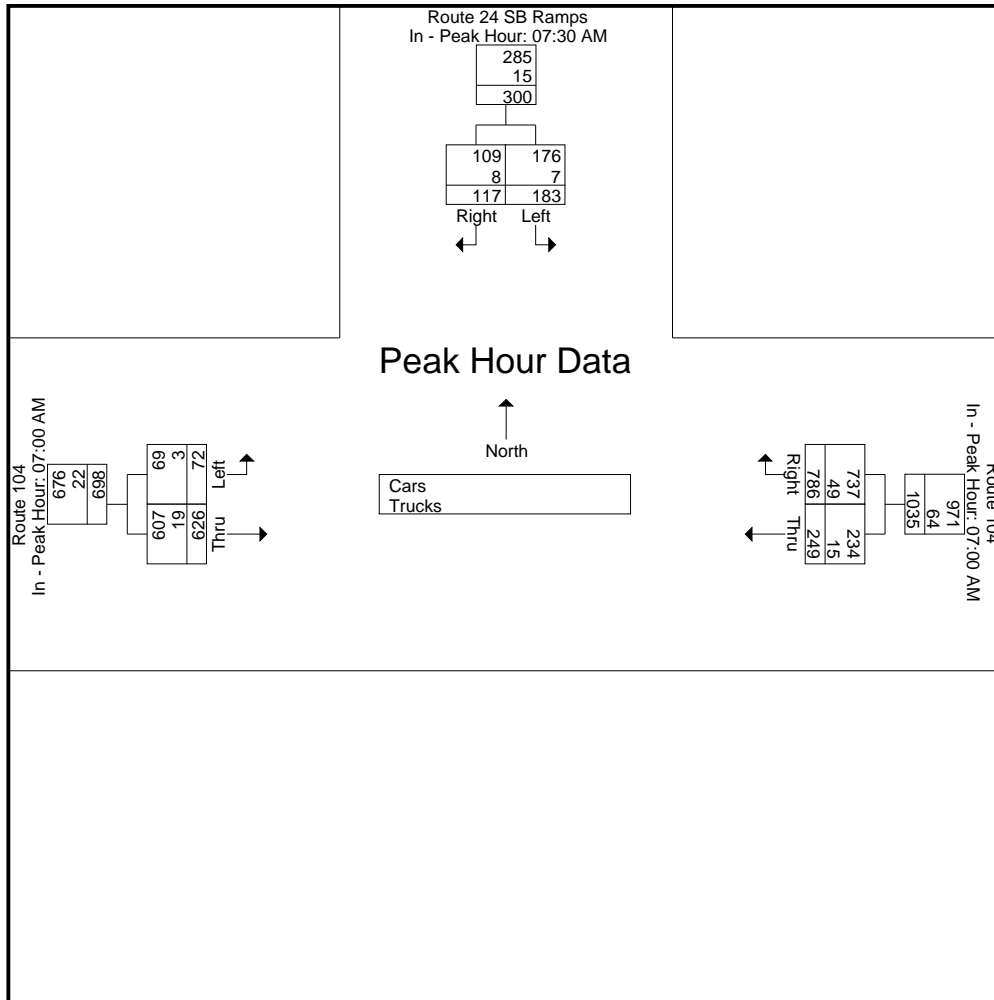

# Accurate Counts

978-664-2565

N/S Street : Route 24 SB Ramps

E/W Street : Route 104

City/State : Bridgewater, MA

Weather : Clear

File Name : 202700B1

Site Code : 20270001

Start Date : 10/2/2024

Page No : 4

## Groups Printed- Cars

Start Time	Route 24 SB Ramps From North		Route 104 From East		Route 104 From West		Int. Total
	Left	Right	Thru	Right	Left	Thru	
07:00 AM	20	17	50	172	18	163	440
07:15 AM	31	25	69	199	20	130	474
07:30 AM	46	24	55	198	16	167	506
07:45 AM	48	24	60	168	15	147	462
<b>Total</b>	<b>145</b>	<b>90</b>	<b>234</b>	<b>737</b>	<b>69</b>	<b>607</b>	<b>1882</b>
08:00 AM	40	23	64	154	15	140	436
08:15 AM	42	38	88	162	19	125	474
08:30 AM	30	25	60	131	20	129	395
08:45 AM	32	26	65	104	6	105	338
<b>Total</b>	<b>144</b>	<b>112</b>	<b>277</b>	<b>551</b>	<b>60</b>	<b>499</b>	<b>1643</b>
<b>Grand Total</b>	<b>289</b>	<b>202</b>	<b>511</b>	<b>1288</b>	<b>129</b>	<b>1106</b>	<b>3525</b>
Apprch %	58.9	41.1	28.4	71.6	10.4	89.6	
Total %	8.2	5.7	14.5	36.5	3.7	31.4	

Start Time	Route 24 SB Ramps From North			Route 104 From East			Route 104 From West			Int. Total
	Left	Right	App. Total	Thru	Right	App. Total	Left	Thru	App. Total	
Peak Hour Analysis From 07:00 AM to 08:45 AM - Peak 1 of 1										
Peak Hour for Entire Intersection Begins at 07:00 AM										
07:00 AM	20	17	37	50	172	222	18	163	181	440
07:15 AM	31	<b>25</b>	56	<b>69</b>	<b>199</b>	<b>268</b>	<b>20</b>	130	150	474
07:30 AM	46	24	70	55	198	253	16	<b>167</b>	<b>183</b>	<b>506</b>
07:45 AM	<b>48</b>	24	<b>72</b>	60	168	228	15	147	162	462
<b>Total Volume</b>	<b>145</b>	<b>90</b>	<b>235</b>	<b>234</b>	<b>737</b>	<b>971</b>	<b>69</b>	<b>607</b>	<b>676</b>	<b>1882</b>
% App. Total	61.7	38.3		24.1	75.9		10.2	89.8		
PHF	.755	.900	.816	.848	.926	.906	.863	.909	.923	.930

# Accurate Counts

978-664-2565

N/S Street : Route 24 SB Ramps  
 E/W Street : Route 104  
 City/State : Bridgewater, MA  
 Weather : Clear

File Name : 202700B1  
 Site Code : 20270001  
 Start Date : 10/2/2024  
 Page No : 5

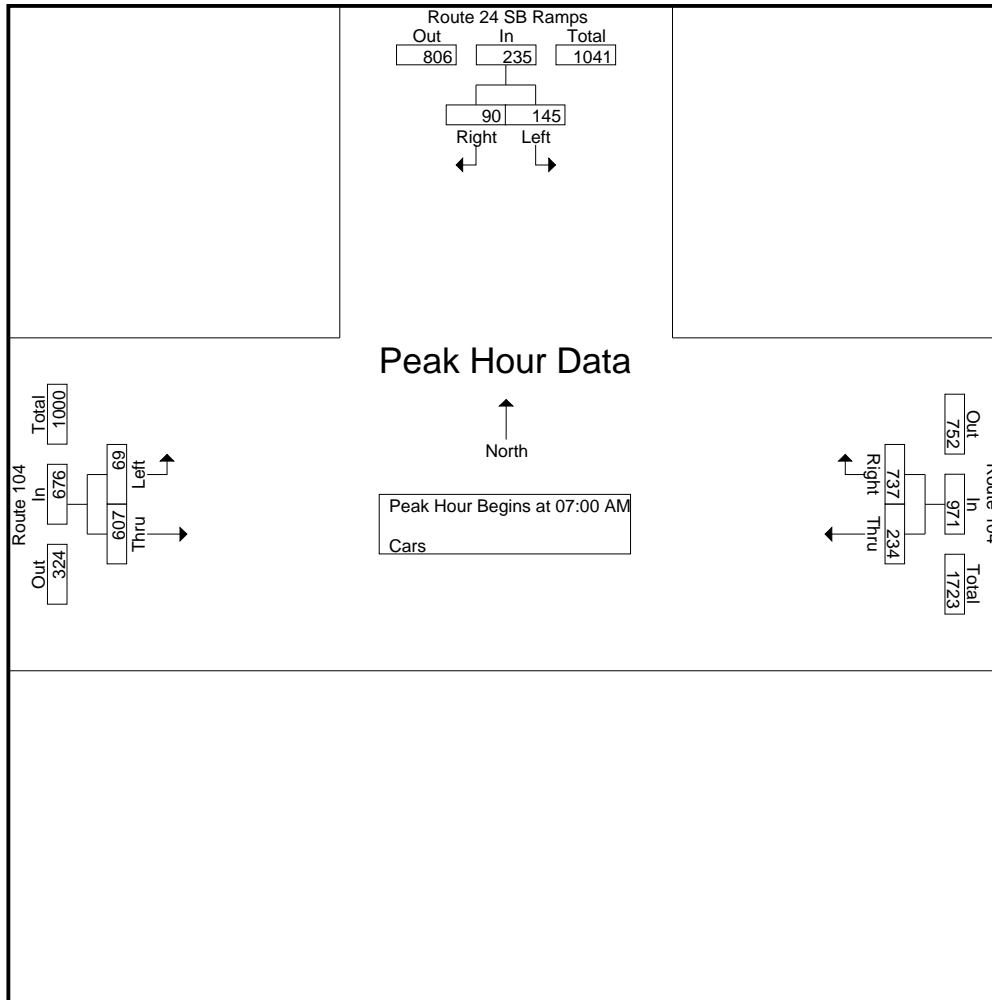

**Peak Hour Analysis From 07:00 AM to 08:45 AM - Peak 1 of 1**

Peak Hour for Each Approach Begins at:

	07:30 AM			07:00 AM			07:00 AM		
+0 mins.	46	24	70	50	172	222	18	163	181
+15 mins.	<b>48</b>	24	72	<b>69</b>	<b>199</b>	<b>268</b>	<b>20</b>	130	150
+30 mins.	40	23	63	55	198	253	16	<b>167</b>	<b>183</b>
+45 mins.	42	<b>38</b>	<b>80</b>	60	168	228	15	147	162
Total Volume	176	109	285	234	737	971	69	607	676
% App. Total	61.8	38.2		24.1	75.9		10.2	89.8	
PHF	.917	.717	.891	.848	.926	.906	.863	.909	.923

# Accurate Counts

978-664-2565

File Name : 202700B1

Site Code : 20270001

Start Date : 10/2/2024

Page No : 6

N/S Street : Route 24 SB Ramps

E/W Street : Route 104

City/State : Bridgewater, MA

Weather : Clear

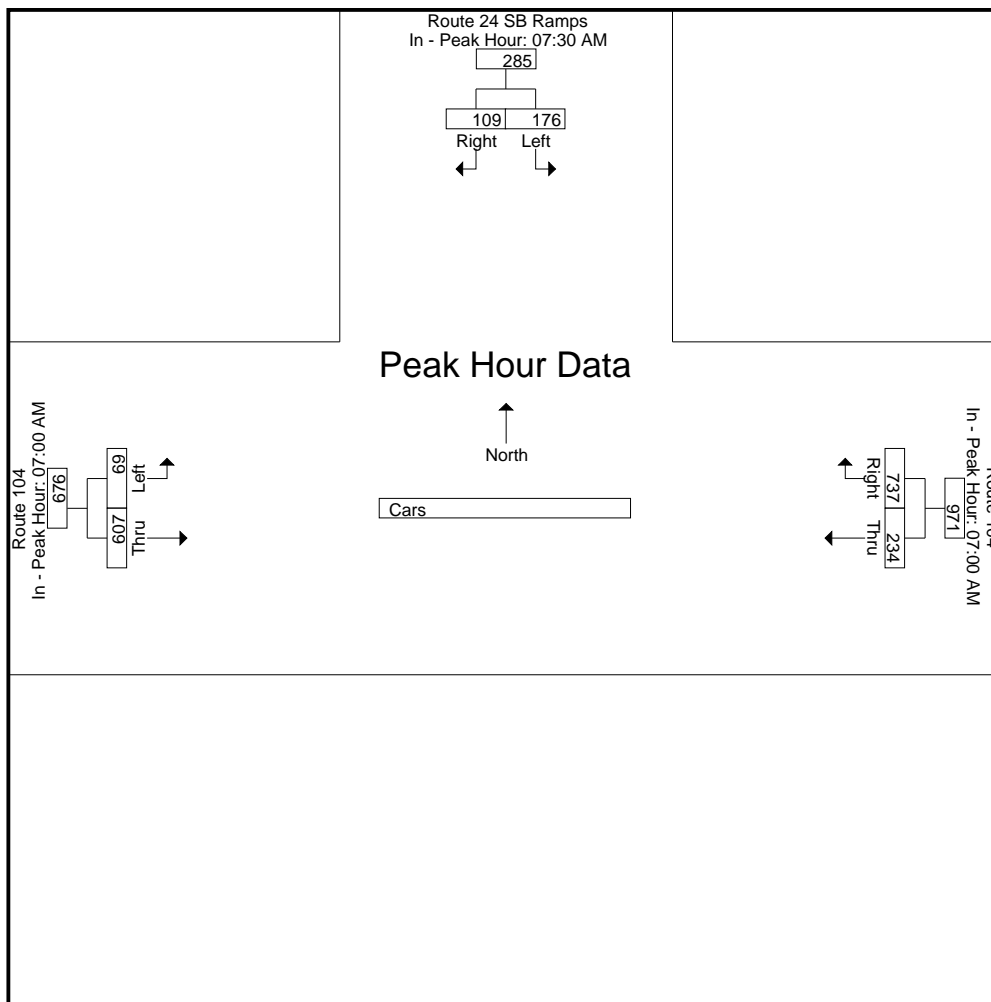

# Accurate Counts

978-664-2565

N/S Street : Route 24 SB Ramps

E/W Street : Route 104

City/State : Bridgewater, MA

Weather : Clear

File Name : 202700B1

Site Code : 20270001

Start Date : 10/2/2024

Page No : 7

### Groups Printed- Trucks

Start Time	Route 24 SB Ramps From North		Route 104 From East		Route 104 From West		Int. Total
	Left	Right	Thru	Right	Left	Thru	
07:00 AM	2	5	2	11	1	10	31
07:15 AM	1	2	5	9	0	3	20
07:30 AM	0	3	4	15	1	2	25
07:45 AM	3	2	4	14	1	4	28
<b>Total</b>	<b>6</b>	<b>12</b>	<b>15</b>	<b>49</b>	<b>3</b>	<b>19</b>	<b>104</b>
08:00 AM	0	2	1	12	3	5	23
08:15 AM	4	1	3	11	1	2	22
08:30 AM	6	2	3	18	0	3	32
08:45 AM	2	0	1	9	2	4	18
<b>Total</b>	<b>12</b>	<b>5</b>	<b>8</b>	<b>50</b>	<b>6</b>	<b>14</b>	<b>95</b>
<b>Grand Total</b>	<b>18</b>	<b>17</b>	<b>23</b>	<b>99</b>	<b>9</b>	<b>33</b>	<b>199</b>
Apprch %	51.4	48.6	18.9	81.1	21.4	78.6	
Total %	9	8.5	11.6	49.7	4.5	16.6	

Start Time	Route 24 SB Ramps From North			Route 104 From East			Route 104 From West			Int. Total
	Left	Right	App. Total	Thru	Right	App. Total	Left	Thru	App. Total	
Peak Hour Analysis From 07:00 AM to 08:45 AM - Peak 1 of 1										
Peak Hour for Entire Intersection Begins at 07:45 AM										
07:45 AM	3	2	5	4	14	18	1	4	5	28
08:00 AM	0	2	2	1	12	13	3	5	8	23
08:15 AM	4	1	5	3	11	14	1	2	3	22
08:30 AM	6	2	8	3	18	21	0	3	3	32
<b>Total Volume</b>	<b>13</b>	<b>7</b>	<b>20</b>	<b>11</b>	<b>55</b>	<b>66</b>	<b>5</b>	<b>14</b>	<b>19</b>	<b>105</b>
% App. Total	65	35		16.7	83.3		26.3	73.7		
PHF	.542	.875	.625	.688	.764	.786	.417	.700	.594	.820

# Accurate Counts

978-664-2565

File Name : 202700B1

Site Code : 20270001

Start Date : 10/2/2024

Page No : 8

N/S Street : Route 24 SB Ramps

E/W Street : Route 104

City/State : Bridgewater, MA

Weather : Clear

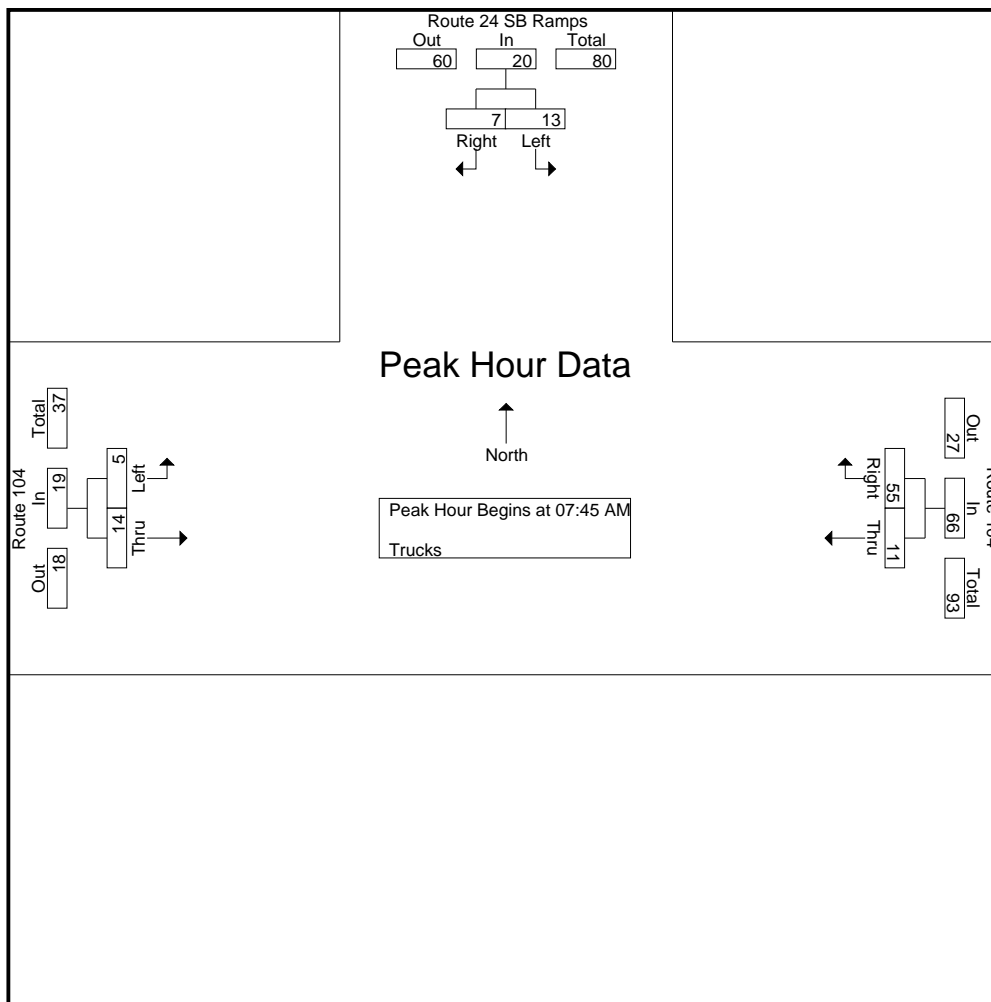

**Peak Hour Analysis From 07:00 AM to 08:45 AM - Peak 1 of 1**

Peak Hour for Each Approach Begins at:

	07:45 AM			07:45 AM			07:00 AM		
+0 mins.	3	2	5	4	14	18	1	10	11
+15 mins.	0	2	2	1	12	13	0	3	3
+30 mins.	4	1	5	3	11	14	1	2	3
+45 mins.	6	2	8	3	18	21	1	4	5
Total Volume	13	7	20	11	55	66	3	19	22
% App. Total	65	35		16.7	83.3		13.6	86.4	
PHF	.542	.875	.625	.688	.764	.786	.750	.475	.500



# Accurate Counts

978-664-2565

File Name : 202700B1

Site Code : 20270001

Start Date : 10/2/2024

Page No : 9

N/S Street : Route 24 SB Ramps

E/W Street : Route 104

City/State : Bridgewater, MA

Weather : Clear

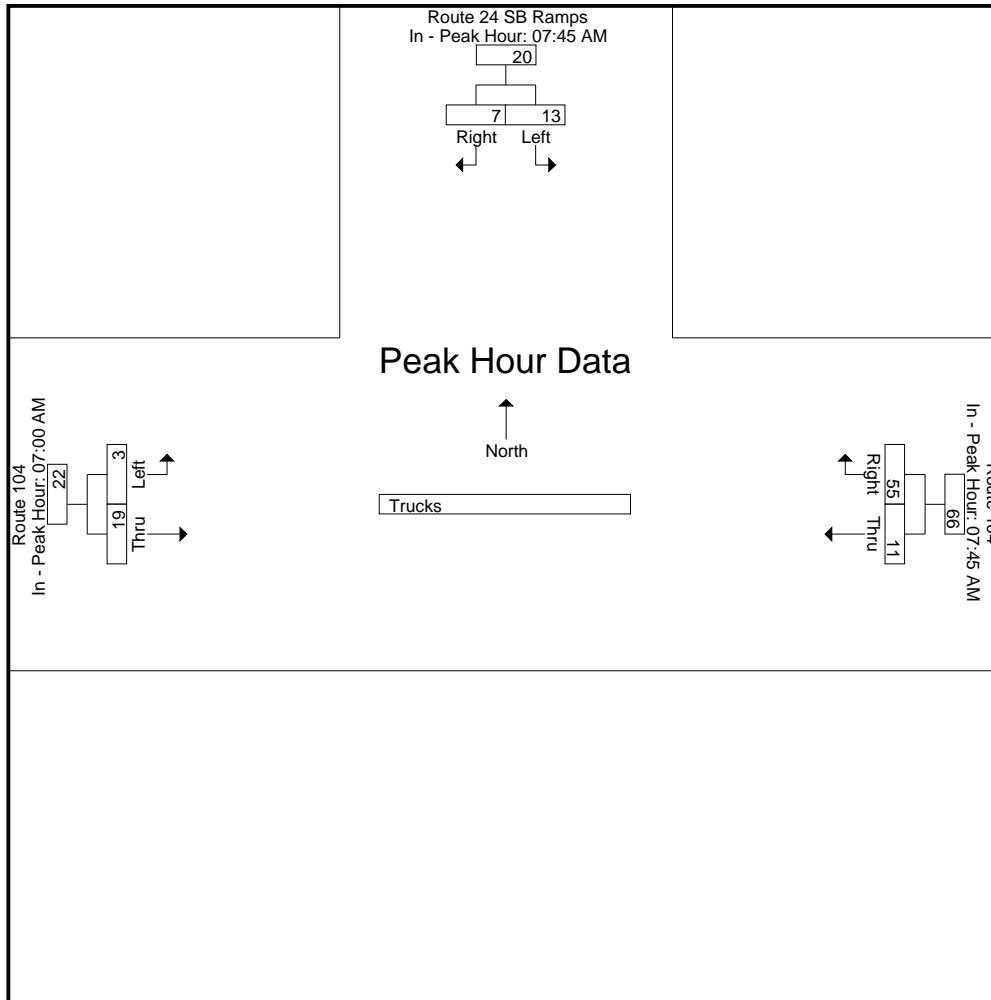





# Accurate Counts

978-664-2565

File Name : 202700B1

Site Code : 20270001

Start Date : 10/2/2024

Page No : 12

N/S Street : Route 24 SB Ramps

E/W Street : Route 104

City/State : Bridgewater, MA

Weather : Clear

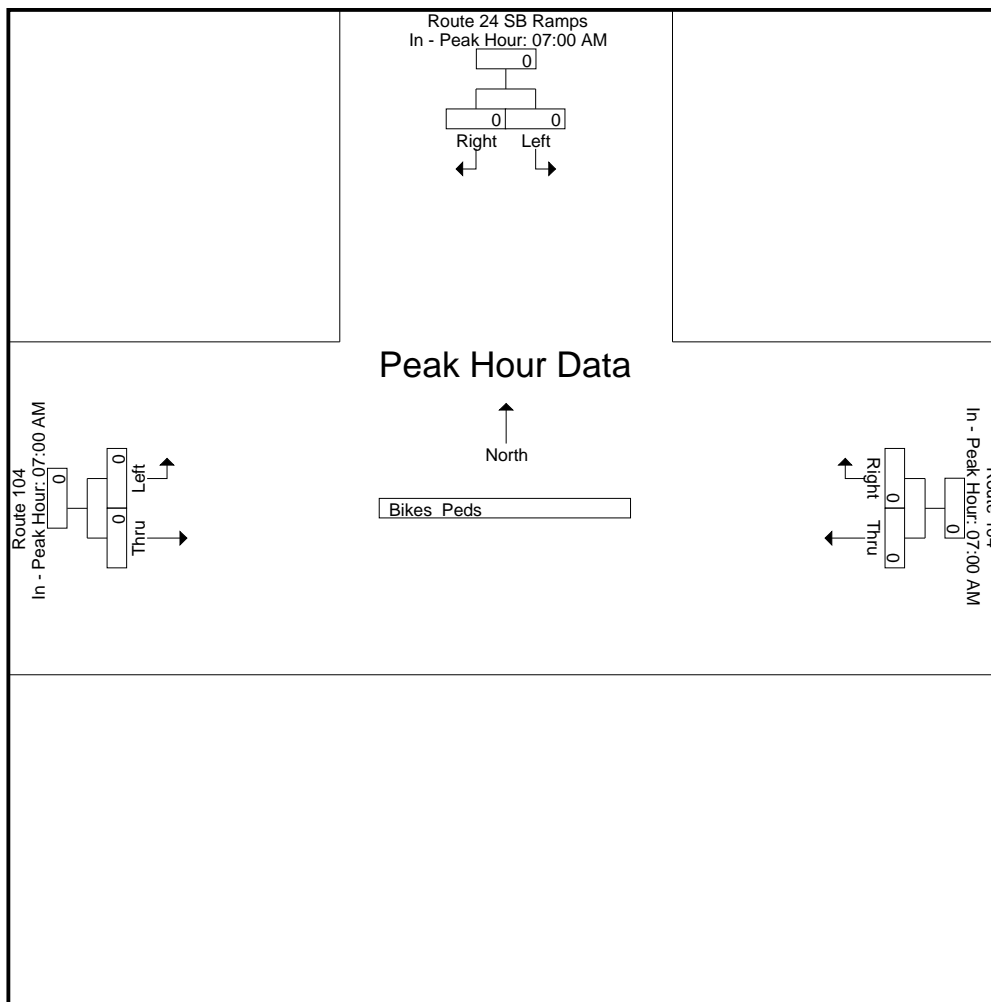

# Accurate Counts

978-664-2565

N/S Street : Route 24 SB Ramps  
 E/W Street : Route 104  
 City/State : Bridgewater, MA  
 Weather : Clear

File Name : 202700B1  
 Site Code : 20270001  
 Start Date : 10/2/2024  
 Page No : 1

### Groups Printed- Cars - Trucks

Start Time	Route 24 SB Ramps From North		Route 104 From East		Route 104 From West		Int. Total
	Left	Right	Thru	Right	Left	Thru	
04:00 PM	96	99	104	150	24	113	586
04:15 PM	116	83	105	140	43	129	616
04:30 PM	96	88	102	172	36	121	615
04:45 PM	95	93	82	153	34	129	586
<b>Total</b>	<b>403</b>	<b>363</b>	<b>393</b>	<b>615</b>	<b>137</b>	<b>492</b>	<b>2403</b>
05:00 PM	85	75	76	150	42	125	553
05:15 PM	75	93	110	146	38	116	578
05:30 PM	92	79	100	140	18	129	558
05:45 PM	77	71	91	115	21	111	486
<b>Total</b>	<b>329</b>	<b>318</b>	<b>377</b>	<b>551</b>	<b>119</b>	<b>481</b>	<b>2175</b>
<b>Grand Total</b>	<b>732</b>	<b>681</b>	<b>770</b>	<b>1166</b>	<b>256</b>	<b>973</b>	<b>4578</b>
Apprch %	51.8	48.2	39.8	60.2	20.8	79.2	
Total %	16	14.9	16.8	25.5	5.6	21.3	
Cars	705	677	764	1135	252	959	4492
% Cars	96.3	99.4	99.2	97.3	98.4	98.6	98.1
Trucks	27	4	6	31	4	14	86
% Trucks	3.7	0.6	0.8	2.7	1.6	1.4	1.9

Start Time	Route 24 SB Ramps From North			Route 104 From East			Route 104 From West			Int. Total
	Left	Right	App. Total	Thru	Right	App. Total	Left	Thru	App. Total	
Peak Hour Analysis From 04:00 PM to 05:45 PM - Peak 1 of 1										
Peak Hour for Entire Intersection Begins at 04:00 PM										
04:00 PM	96	<b>99</b>	195	104	150	254	24	113	137	586
04:15 PM	<b>116</b>	83	<b>199</b>	<b>105</b>	140	245	<b>43</b>	<b>129</b>	<b>172</b>	<b>616</b>
04:30 PM	96	88	184	102	<b>172</b>	<b>274</b>	36	121	157	615
04:45 PM	95	93	188	82	153	235	34	129	163	586
<b>Total Volume</b>	<b>403</b>	<b>363</b>	<b>766</b>	<b>393</b>	<b>615</b>	<b>1008</b>	<b>137</b>	<b>492</b>	<b>629</b>	<b>2403</b>
% App. Total	52.6	47.4		39	61		21.8	78.2		
PHF	.869	.917	.962	.936	.894	.920	.797	.953	.914	.975
Cars	385	360	745	388	595	983	134	487	621	2349
% Cars	95.5	99.2	97.3	98.7	96.7	97.5	97.8	99.0	98.7	97.8
Trucks	18	3	21	5	20	25	3	5	8	54
% Trucks	4.5	0.8	2.7	1.3	3.3	2.5	2.2	1.0	1.3	2.2

# Accurate Counts

978-664-2565

N/S Street : Route 24 SB Ramps  
 E/W Street : Route 104  
 City/State : Bridgewater, MA  
 Weather : Clear

File Name : 202700B1  
 Site Code : 20270001  
 Start Date : 10/2/2024  
 Page No : 2

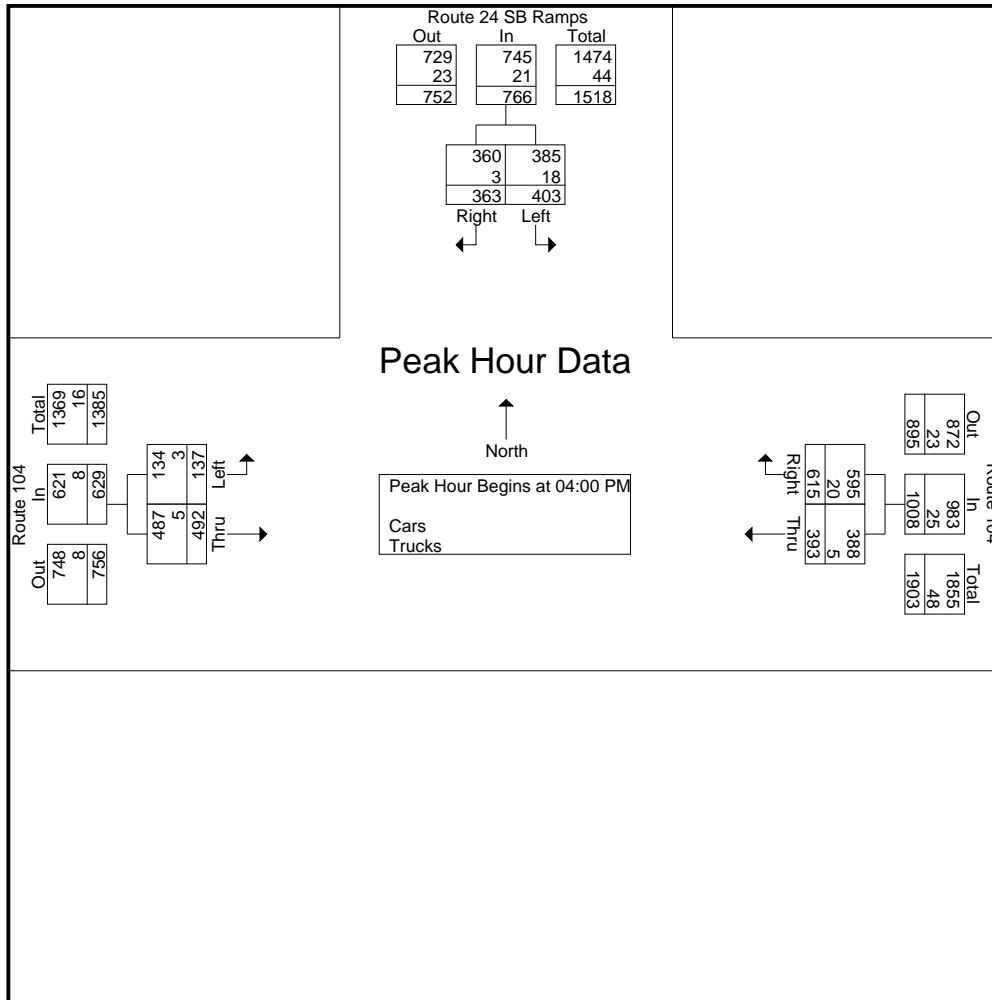

**Peak Hour Analysis From 04:00 PM to 05:45 PM - Peak 1 of 1**

Peak Hour for Each Approach Begins at:

	04:00 PM			04:00 PM			04:15 PM		
+0 mins.	96	<b>99</b>	195	104	150	254	<b>43</b>	<b>129</b>	<b>172</b>
+15 mins.	<b>116</b>	83	<b>199</b>	<b>105</b>	140	245	36	121	157
+30 mins.	96	88	184	102	<b>172</b>	<b>274</b>	34	129	163
+45 mins.	95	93	188	82	153	235	42	125	167
Total Volume	403	363	766	393	615	1008	155	504	659
% App. Total	52.6	47.4		39	61		23.5	76.5	
PHF	.869	.917	.962	.936	.894	.920	.901	.977	.958
Cars	385	360	745	388	595	983	152	497	649
% Cars	95.5	99.2	97.3	98.7	96.7	97.5	98.1	98.6	98.5
Trucks	18	3	21	5	20	25	3	7	10
% Trucks	4.5	0.8	2.7	1.3	3.3	2.5	1.9	1.4	1.5

# Accurate Counts

978-664-2565

File Name : 202700B1

Site Code : 20270001

Start Date : 10/2/2024

Page No : 3

N/S Street : Route 24 SB Ramps

E/W Street : Route 104

City/State : Bridgewater, MA

Weather : Clear

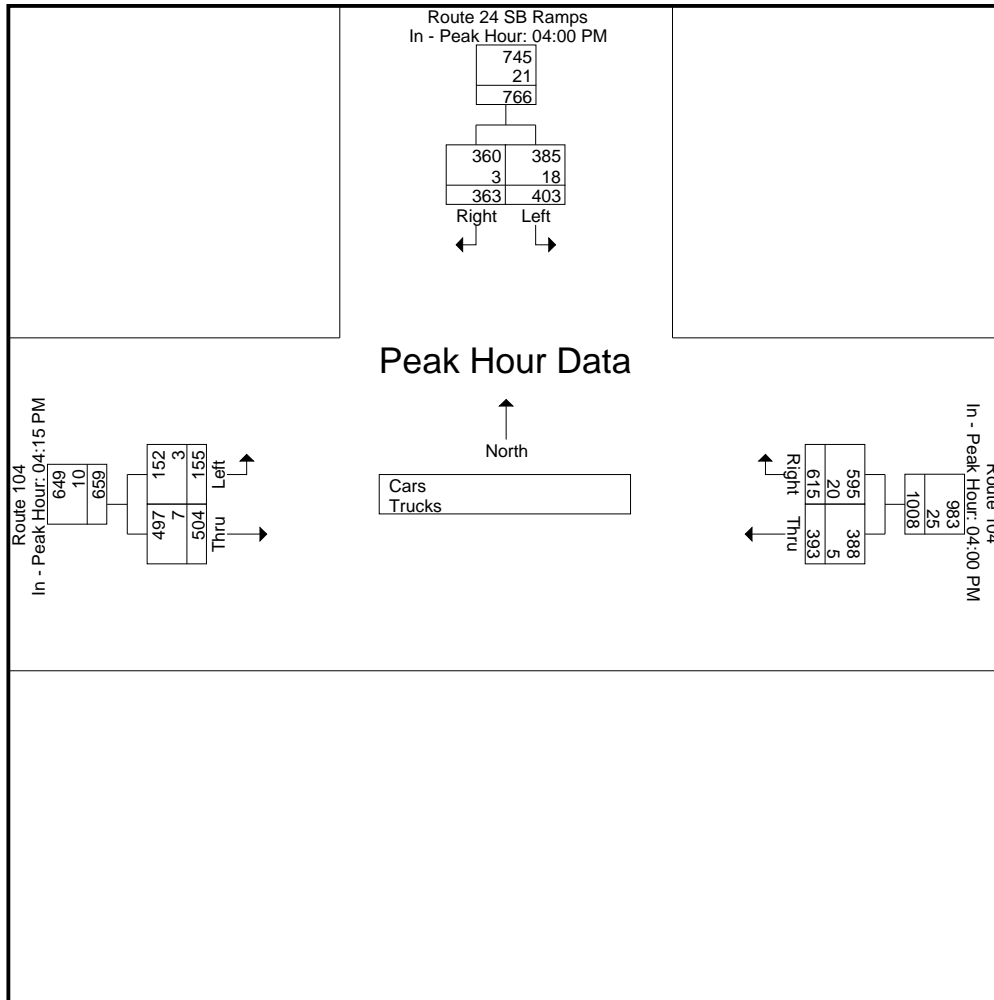

# Accurate Counts

978-664-2565

N/S Street : Route 24 SB Ramps  
 E/W Street : Route 104  
 City/State : Bridgewater, MA  
 Weather : Clear

File Name : 202700B1  
 Site Code : 20270001  
 Start Date : 10/2/2024  
 Page No : 4

## Groups Printed- Cars

Start Time	Route 24 SB Ramps From North		Route 104 From East		Route 104 From West		Int. Total
	Left	Right	Thru	Right	Left	Thru	
04:00 PM	91	97	103	144	23	113	571
04:15 PM	111	82	105	137	41	125	601
04:30 PM	93	88	100	166	36	121	604
04:45 PM	90	93	80	148	34	128	573
<b>Total</b>	<b>385</b>	<b>360</b>	<b>388</b>	<b>595</b>	<b>134</b>	<b>487</b>	<b>2349</b>
05:00 PM	81	75	75	148	41	123	543
05:15 PM	75	93	110	142	38	115	573
05:30 PM	89	78	100	138	18	124	547
05:45 PM	75	71	91	112	21	110	480
<b>Total</b>	<b>320</b>	<b>317</b>	<b>376</b>	<b>540</b>	<b>118</b>	<b>472</b>	<b>2143</b>
<b>Grand Total</b>	<b>705</b>	<b>677</b>	<b>764</b>	<b>1135</b>	<b>252</b>	<b>959</b>	<b>4492</b>
Apprch %	51	49	40.2	59.8	20.8	79.2	
Total %	15.7	15.1	17	25.3	5.6	21.3	

Start Time	Route 24 SB Ramps From North			Route 104 From East			Route 104 From West			Int. Total
	Left	Right	App. Total	Thru	Right	App. Total	Left	Thru	App. Total	
Peak Hour Analysis From 04:00 PM to 05:45 PM - Peak 1 of 1										
Peak Hour for Entire Intersection Begins at 04:00 PM										
04:00 PM	91	<b>97</b>	188	103	144	247	23	113	136	571
04:15 PM	<b>111</b>	82	<b>193</b>	<b>105</b>	137	242	<b>41</b>	125	<b>166</b>	601
04:30 PM	93	88	181	100	<b>166</b>	<b>266</b>	36	121	157	<b>604</b>
04:45 PM	90	93	183	80	148	228	34	<b>128</b>	162	573
<b>Total Volume</b>	<b>385</b>	<b>360</b>	<b>745</b>	<b>388</b>	<b>595</b>	<b>983</b>	<b>134</b>	<b>487</b>	<b>621</b>	<b>2349</b>
% App. Total	51.7	48.3		39.5	60.5		21.6	78.4		
PHF	.867	.928	.965	.924	.896	.924	.817	.951	.935	.972



# Accurate Counts

978-664-2565

File Name : 202700B1

Site Code : 20270001

Start Date : 10/2/2024

Page No : 5

N/S Street : Route 24 SB Ramps

E/W Street : Route 104

City/State : Bridgewater, MA

Weather : Clear

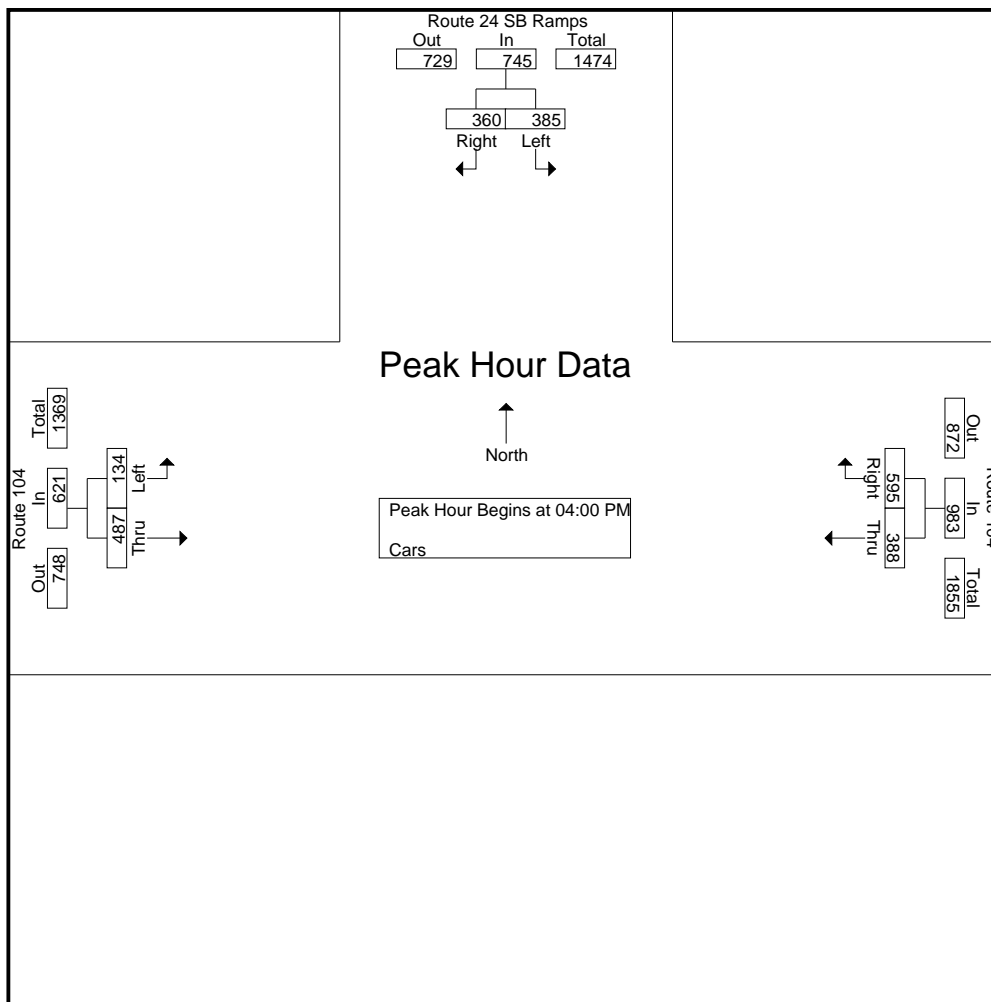

**Peak Hour Analysis From 04:00 PM to 05:45 PM - Peak 1 of 1**

Peak Hour for Each Approach Begins at:

	04:00 PM			04:00 PM			04:15 PM		
+0 mins.	91	<b>97</b>	188	103	144	247	<b>41</b>	125	<b>166</b>
+15 mins.	<b>111</b>	82	<b>193</b>	<b>105</b>	137	242	36	121	157
+30 mins.	93	88	181	100	<b>166</b>	<b>266</b>	34	<b>128</b>	162
+45 mins.	90	93	183	80	148	228	41	123	164
Total Volume	385	360	745	388	595	983	152	497	649
% App. Total	51.7	48.3		39.5	60.5		23.4	76.6	
PHF	.867	.928	.965	.924	.896	.924	.927	.971	.977

# Accurate Counts

978-664-2565

File Name : 202700B1

Site Code : 20270001

Start Date : 10/2/2024

Page No : 6

N/S Street : Route 24 SB Ramps

E/W Street : Route 104

City/State : Bridgewater, MA

Weather : Clear

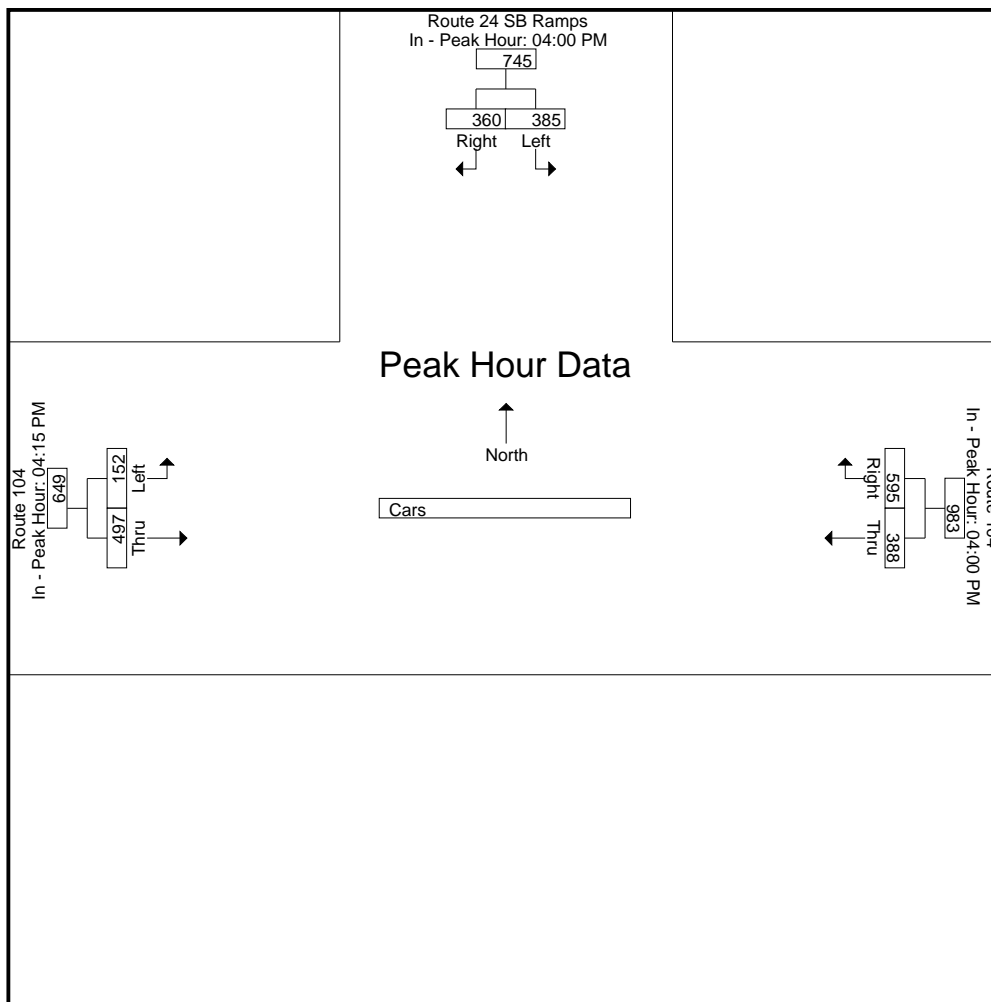

# Accurate Counts

978-664-2565

N/S Street : Route 24 SB Ramps  
 E/W Street : Route 104  
 City/State : Bridgewater, MA  
 Weather : Clear

File Name : 202700B1  
 Site Code : 20270001  
 Start Date : 10/2/2024  
 Page No : 7

### Groups Printed- Trucks

Start Time	Route 24 SB Ramps From North		Route 104 From East		Route 104 From West		Int. Total
	Left	Right	Thru	Right	Left	Thru	
04:00 PM	5	2	1	6	1	0	15
04:15 PM	5	1	0	3	2	4	15
04:30 PM	3	0	2	6	0	0	11
04:45 PM	5	0	2	5	0	1	13
<b>Total</b>	<b>18</b>	<b>3</b>	<b>5</b>	<b>20</b>	<b>3</b>	<b>5</b>	<b>54</b>
05:00 PM	4	0	1	2	1	2	10
05:15 PM	0	0	0	4	0	1	5
05:30 PM	3	1	0	2	0	5	11
05:45 PM	2	0	0	3	0	1	6
<b>Total</b>	<b>9</b>	<b>1</b>	<b>1</b>	<b>11</b>	<b>1</b>	<b>9</b>	<b>32</b>
<b>Grand Total</b>	<b>27</b>	<b>4</b>	<b>6</b>	<b>31</b>	<b>4</b>	<b>14</b>	<b>86</b>
Apprch %	87.1	12.9	16.2	83.8	22.2	77.8	
Total %	31.4	4.7	7	36	4.7	16.3	

Start Time	Route 24 SB Ramps From North			Route 104 From East			Route 104 From West			Int. Total
	Left	Right	App. Total	Thru	Right	App. Total	Left	Thru	App. Total	
Peak Hour Analysis From 04:00 PM to 05:45 PM - Peak 1 of 1										
Peak Hour for Entire Intersection Begins at 04:00 PM										
04:00 PM	5	2	7	1	6	7	1	0	1	15
04:15 PM	5	1	6	0	3	3	2	4	6	15
04:30 PM	3	0	3	2	6	8	0	0	0	11
04:45 PM	5	0	5	2	5	7	0	1	1	13
<b>Total Volume</b>	<b>18</b>	<b>3</b>	<b>21</b>	<b>5</b>	<b>20</b>	<b>25</b>	<b>3</b>	<b>5</b>	<b>8</b>	<b>54</b>
% App. Total	85.7	14.3		20	80		37.5	62.5		
PHF	.900	.375	.750	.625	.833	.781	.375	.313	.333	.900

# Accurate Counts

978-664-2565

N/S Street : Route 24 SB Ramps  
 E/W Street : Route 104  
 City/State : Bridgewater, MA  
 Weather : Clear

File Name : 202700B1  
 Site Code : 20270001  
 Start Date : 10/2/2024  
 Page No : 8

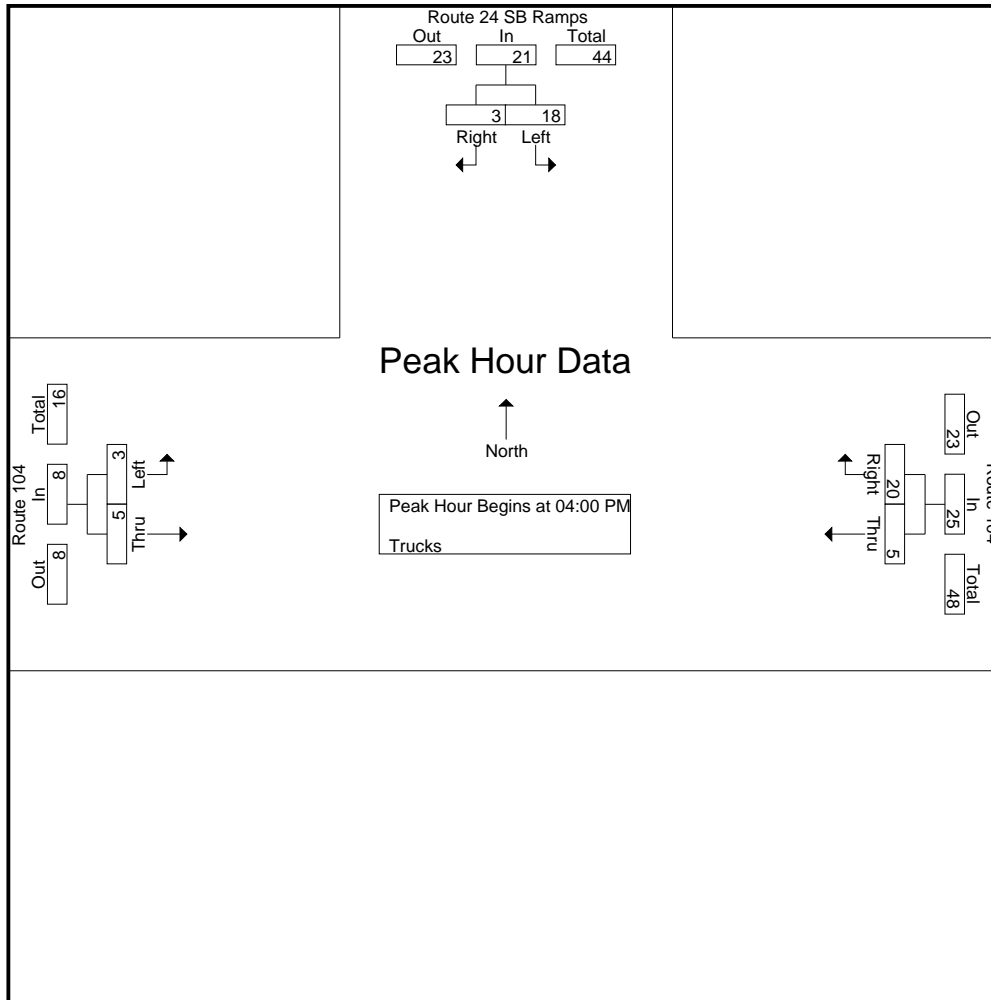

**Peak Hour Analysis From 04:00 PM to 05:45 PM - Peak 1 of 1**

Peak Hour for Each Approach Begins at:

	04:00 PM			04:00 PM			04:15 PM		
+0 mins.	5	2	7	1	6	7	2	4	6
+15 mins.	5	1	6	0	3	3	0	0	0
+30 mins.	3	0	3	2	6	8	0	1	1
+45 mins.	5	0	5	2	5	7	1	2	3
Total Volume	18	3	21	5	20	25	3	7	10
% App. Total	85.7	14.3		20	80		30	70	
PHF	.900	.375	.750	.625	.833	.781	.375	.438	.417

# Accurate Counts

978-664-2565

File Name : 202700B1

Site Code : 20270001

Start Date : 10/2/2024

Page No : 9

N/S Street : Route 24 SB Ramps

E/W Street : Route 104

City/State : Bridgewater, MA

Weather : Clear

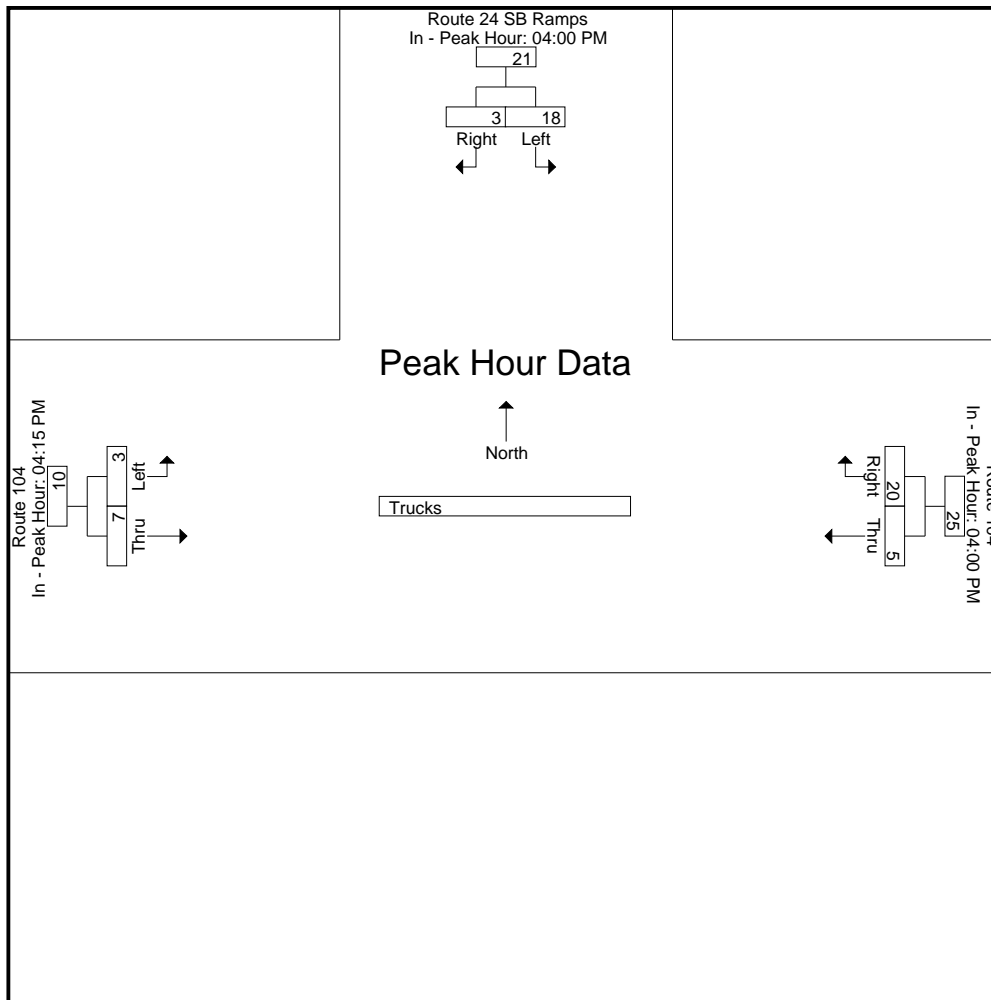



# Accurate Counts

978-664-2565

N/S Street : Route 24 SB Ramps  
 E/W Street : Route 104  
 City/State : Bridgewater, MA  
 Weather : Clear

File Name : 202700B1  
 Site Code : 20270001  
 Start Date : 10/2/2024  
 Page No : 11

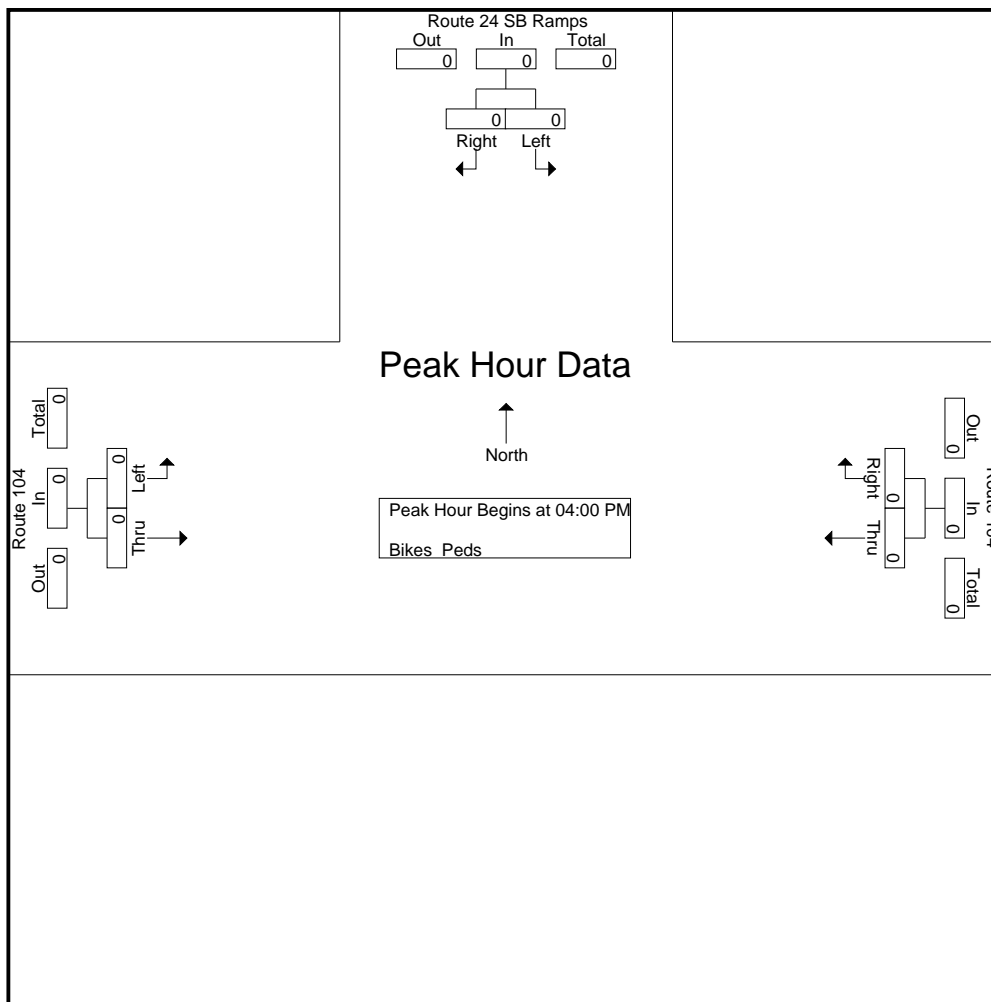

**Peak Hour Analysis From 04:00 PM to 05:45 PM - Peak 1 of 1**

Peak Hour for Each Approach Begins at:

	04:00 PM			04:00 PM			04:00 PM		
+0 mins.	0	0	0	0	0	0	0	0	0
+15 mins.	0	0	0	0	0	0	0	0	0
+30 mins.	0	0	0	0	0	0	0	0	0
+45 mins.	0	0	0	0	0	0	0	0	0
Total Volume	0	0	0	0	0	0	0	0	0
% App. Total	0	0	0	0	0	0	0	0	0
PHF	.000	.000	.000	.000	.000	.000	.000	.000	.000

# Accurate Counts

978-664-2565

File Name : 202700B1

Site Code : 20270001

Start Date : 10/2/2024

Page No : 12

N/S Street : Route 24 SB Ramps

E/W Street : Route 104

City/State : Bridgewater, MA

Weather : Clear

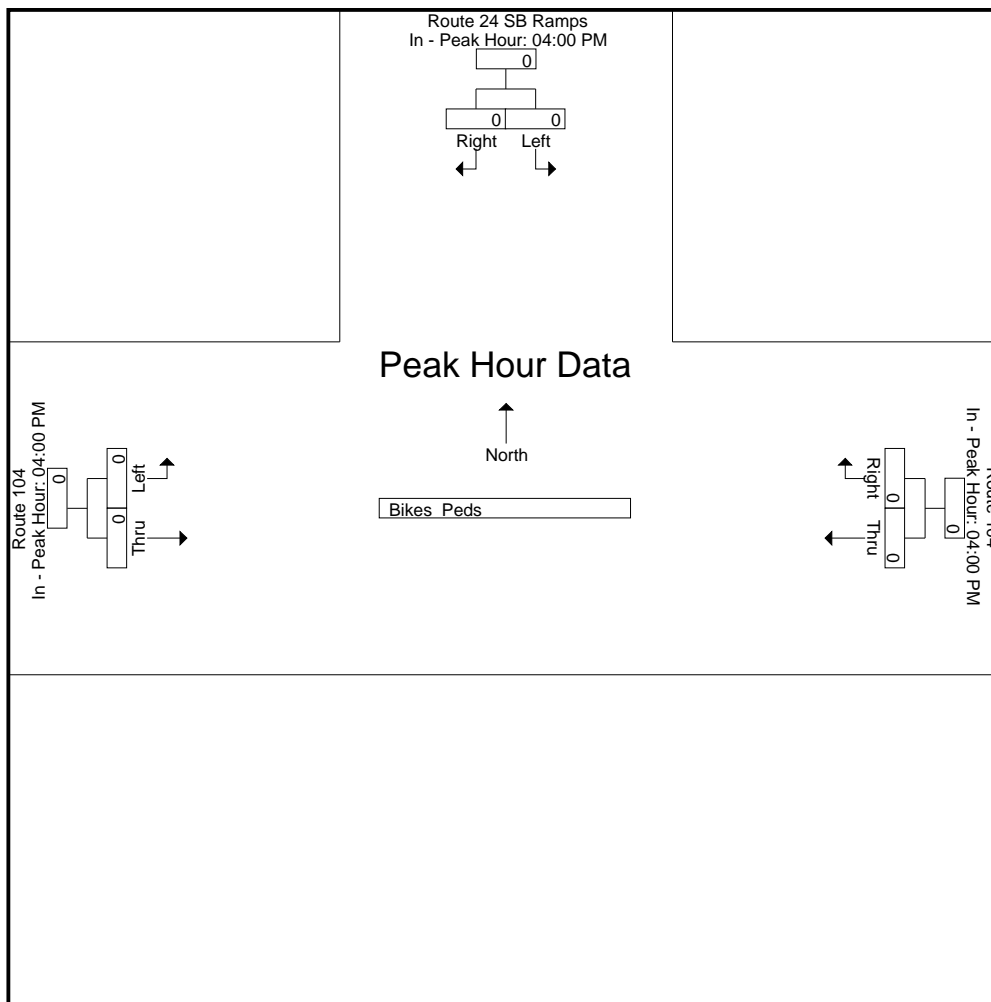



# Accurate Counts

978-664-2565

N/S Street : Mill Street  
 E/W Street : Plymouth Street  
 City/State : Bridgewater, MA  
 Weather : Clear

File Name : 20270B20  
 Site Code : 20270020  
 Start Date : 10/2/2024  
 Page No : 1

### Groups Printed- Cars - Trucks

Start Time	Mill St From North		Plymouth St From East		Plymouth St From West		Int. Total
	Left	Right	Thru	Right	Left	Thru	
07:00 AM	0	11	63	1	6	61	142
07:15 AM	4	5	76	0	8	63	156
07:30 AM	3	15	89	5	9	58	179
07:45 AM	1	14	86	4	7	67	179
<b>Total</b>	<b>8</b>	<b>45</b>	<b>314</b>	<b>10</b>	<b>30</b>	<b>249</b>	<b>656</b>
08:00 AM	3	13	75	2	14	63	170
08:15 AM	3	14	88	4	2	49	160
08:30 AM	2	14	88	4	11	56	175
08:45 AM	3	13	70	1	6	35	128
<b>Total</b>	<b>11</b>	<b>54</b>	<b>321</b>	<b>11</b>	<b>33</b>	<b>203</b>	<b>633</b>
<b>Grand Total</b>	<b>19</b>	<b>99</b>	<b>635</b>	<b>21</b>	<b>63</b>	<b>452</b>	<b>1289</b>
Apprch %	16.1	83.9	96.8	3.2	12.2	87.8	
Total %	1.5	7.7	49.3	1.6	4.9	35.1	
Cars	17	94	606	17	58	422	1214
% Cars	89.5	94.9	95.4	81	92.1	93.4	94.2
Trucks	2	5	29	4	5	30	75
% Trucks	10.5	5.1	4.6	19	7.9	6.6	5.8

Start Time	Mill St From North			Plymouth St From East			Plymouth St From West			Int. Total
	Left	Right	App. Total	Thru	Right	App. Total	Left	Thru	App. Total	
Peak Hour Analysis From 07:00 AM to 08:45 AM - Peak 1 of 1										
Peak Hour for Entire Intersection Begins at 07:30 AM										
07:30 AM	<b>3</b>	<b>15</b>	<b>18</b>	<b>89</b>	<b>5</b>	<b>94</b>	9	58	67	<b>179</b>
07:45 AM	1	14	15	86	4	90	7	<b>67</b>	74	179
08:00 AM	3	13	16	75	2	77	<b>14</b>	63	<b>77</b>	170
08:15 AM	3	14	17	88	4	92	2	49	51	160
<b>Total Volume</b>	<b>10</b>	<b>56</b>	<b>66</b>	<b>338</b>	<b>15</b>	<b>353</b>	<b>32</b>	<b>237</b>	<b>269</b>	<b>688</b>
% App. Total	15.2	84.8		95.8	4.2		11.9	88.1		
PHF	.833	.933	.917	.949	.750	.939	.571	.884	.873	.961
Cars	8	52	60	322	13	335	29	224	253	648
% Cars	80.0	92.9	90.9	95.3	86.7	94.9	90.6	94.5	94.1	94.2
Trucks	2	4	6	16	2	18	3	13	16	40
% Trucks	20.0	7.1	9.1	4.7	13.3	5.1	9.4	5.5	5.9	5.8

# Accurate Counts

978-664-2565

File Name : 20270B20

Site Code : 20270020

Start Date : 10/2/2024

Page No : 2

N/S Street : Mill Street  
 E/W Street : Plymouth Street  
 City/State : Bridgewater, MA  
 Weather : Clear

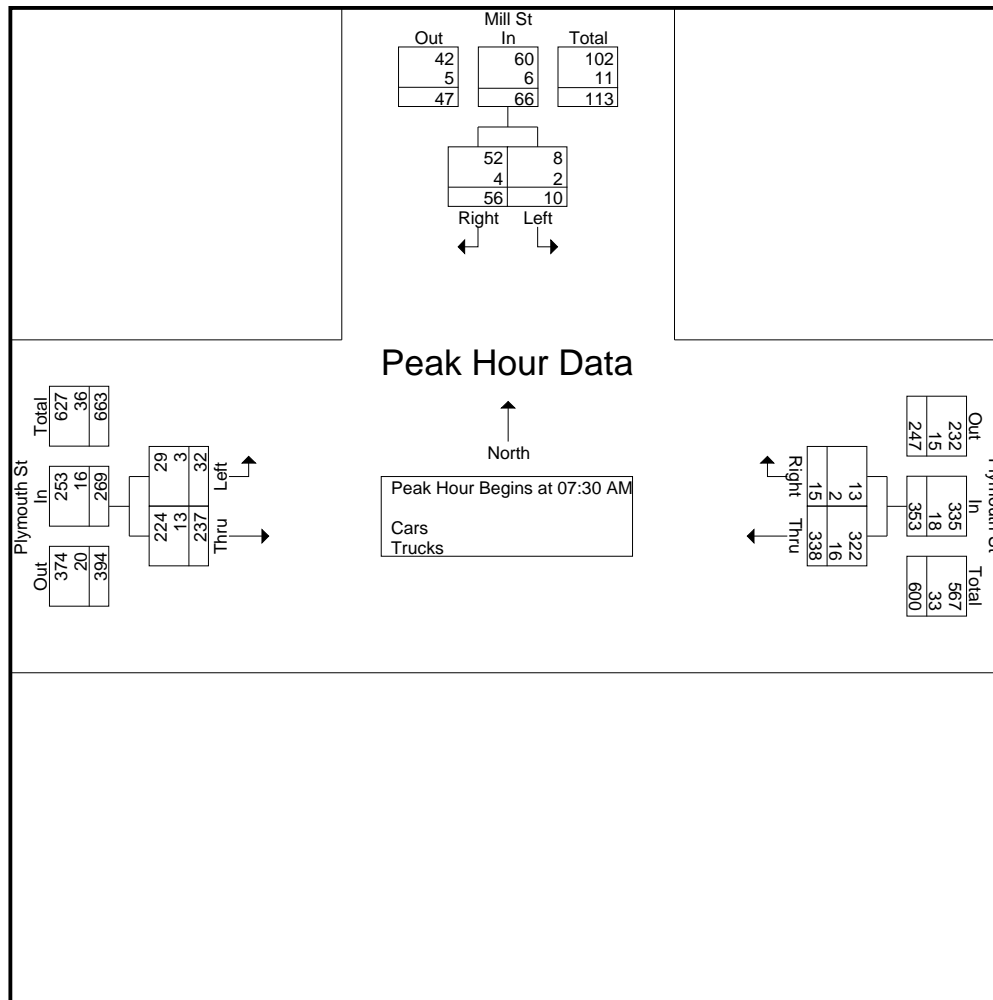

### Peak Hour Analysis From 07:00 AM to 08:45 AM - Peak 1 of 1

Peak Hour for Each Approach Begins at:

	07:30 AM			07:30 AM			07:15 AM		
+0 mins.	<b>3</b>	<b>15</b>	<b>18</b>	<b>89</b>	<b>5</b>	<b>94</b>	8	63	71
+15 mins.	1	14	15	86	4	90	9	58	67
+30 mins.	3	13	16	75	2	77	7	<b>67</b>	74
+45 mins.	3	14	17	88	4	92	<b>14</b>	63	<b>77</b>
Total Volume	10	56	66	338	15	353	38	251	289
% App. Total	15.2	84.8		95.8	4.2		13.1	86.9	
PHF	.833	.933	.917	.949	.750	.939	.679	.937	.938
Cars	8	52	60	322	13	335	34	239	273
% Cars	80	92.9	90.9	95.3	86.7	94.9	89.5	95.2	94.5
Trucks	2	4	6	16	2	18	4	12	16
% Trucks	20	7.1	9.1	4.7	13.3	5.1	10.5	4.8	5.5

# Accurate Counts

978-664-2565

File Name : 20270B20

Site Code : 20270020

Start Date : 10/2/2024

Page No : 3

N/S Street : Mill Street

E/W Street : Plymouth Street

City/State : Bridgewater, MA

Weather : Clear

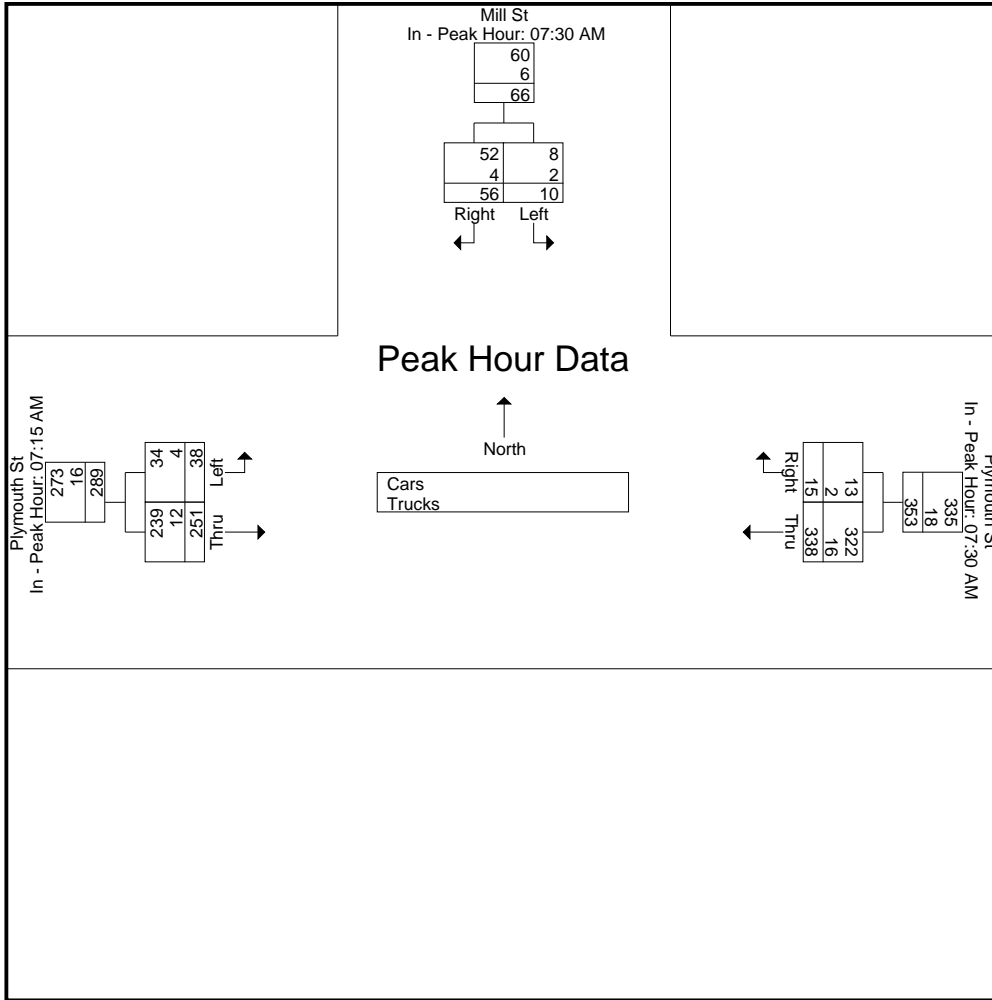

# Accurate Counts

978-664-2565

N/S Street : Mill Street  
 E/W Street : Plymouth Street  
 City/State : Bridgewater, MA  
 Weather : Clear

File Name : 20270B20  
 Site Code : 20270020  
 Start Date : 10/2/2024  
 Page No : 4

## Groups Printed- Cars

Start Time	Mill St From North		Plymouth St From East		Plymouth St From West		Int. Total
	Left	Right	Thru	Right	Left	Thru	
07:00 AM	0	10	60	0	6	57	133
07:15 AM	4	5	75	0	7	61	152
07:30 AM	3	14	85	5	8	53	168
07:45 AM	0	13	84	3	6	65	171
<b>Total</b>	<b>7</b>	<b>42</b>	<b>304</b>	<b>8</b>	<b>27</b>	<b>236</b>	<b>624</b>
08:00 AM	2	11	70	1	13	60	157
08:15 AM	3	14	83	4	2	46	152
08:30 AM	2	14	87	3	10	48	164
08:45 AM	3	13	62	1	6	32	117
<b>Total</b>	<b>10</b>	<b>52</b>	<b>302</b>	<b>9</b>	<b>31</b>	<b>186</b>	<b>590</b>
<b>Grand Total</b>	<b>17</b>	<b>94</b>	<b>606</b>	<b>17</b>	<b>58</b>	<b>422</b>	<b>1214</b>
Apprch %	15.3	84.7	97.3	2.7	12.1	87.9	
Total %	1.4	7.7	49.9	1.4	4.8	34.8	

Start Time	Mill St From North			Plymouth St From East			Plymouth St From West			Int. Total
	Left	Right	App. Total	Thru	Right	App. Total	Left	Thru	App. Total	
Peak Hour Analysis From 07:00 AM to 08:45 AM - Peak 1 of 1										
Peak Hour for Entire Intersection Begins at 07:15 AM										
07:15 AM	<b>4</b>	5	9	75	0	75	7	61	68	152
07:30 AM	3	<b>14</b>	<b>17</b>	<b>85</b>	<b>5</b>	<b>90</b>	8	53	61	168
07:45 AM	0	13	13	84	3	87	6	<b>65</b>	71	<b>171</b>
08:00 AM	2	11	13	70	1	71	<b>13</b>	60	<b>73</b>	157
Total Volume	9	43	52	314	9	323	34	239	273	648
% App. Total	17.3	82.7		97.2	2.8		12.5	87.5		
PHF	.563	.768	.765	.924	.450	.897	.654	.919	.935	.947

# Accurate Counts

978-664-2565

N/S Street : Mill Street  
 E/W Street : Plymouth Street  
 City/State : Bridgewater, MA  
 Weather : Clear

File Name : 20270B20  
 Site Code : 20270020  
 Start Date : 10/2/2024  
 Page No : 5

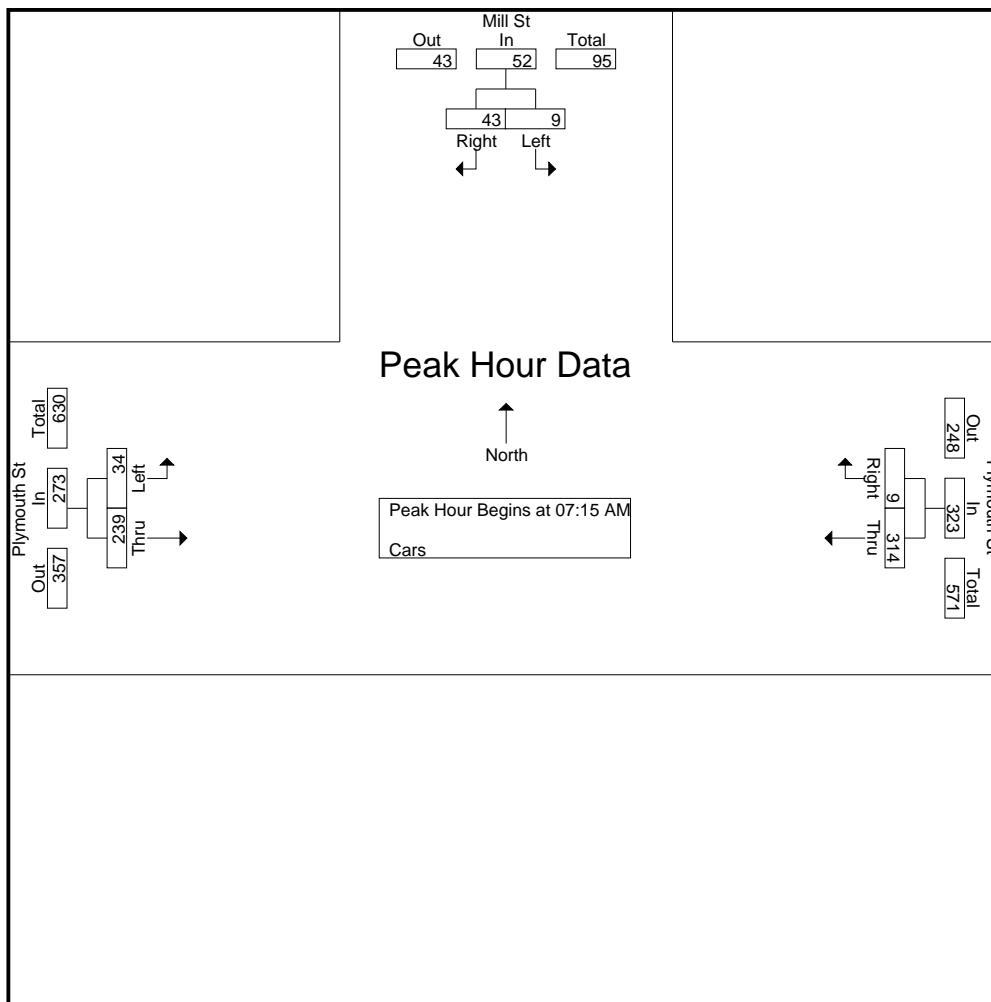

**Peak Hour Analysis From 07:00 AM to 08:45 AM - Peak 1 of 1**

Peak Hour for Each Approach Begins at:

	08:00 AM			07:30 AM			07:15 AM		
+0 mins.	2	11	13	<b>85</b>	<b>5</b>	<b>90</b>	7	61	68
+15 mins.	<b>3</b>	<b>14</b>	<b>17</b>	84	3	87	8	53	61
+30 mins.	2	14	16	70	1	71	6	<b>65</b>	71
+45 mins.	3	13	16	83	4	87	<b>13</b>	60	<b>73</b>
Total Volume	10	52	62	322	13	335	34	239	273
% App. Total	16.1	83.9		96.1	3.9		12.5	87.5	
PHF	.833	.929	.912	.947	.650	.931	.654	.919	.935

# Accurate Counts

978-664-2565

File Name : 20270B20

Site Code : 20270020

Start Date : 10/2/2024

Page No : 6

N/S Street : Mill Street  
E/W Street : Plymouth Street  
City/State : Bridgewater, MA  
Weather : Clear

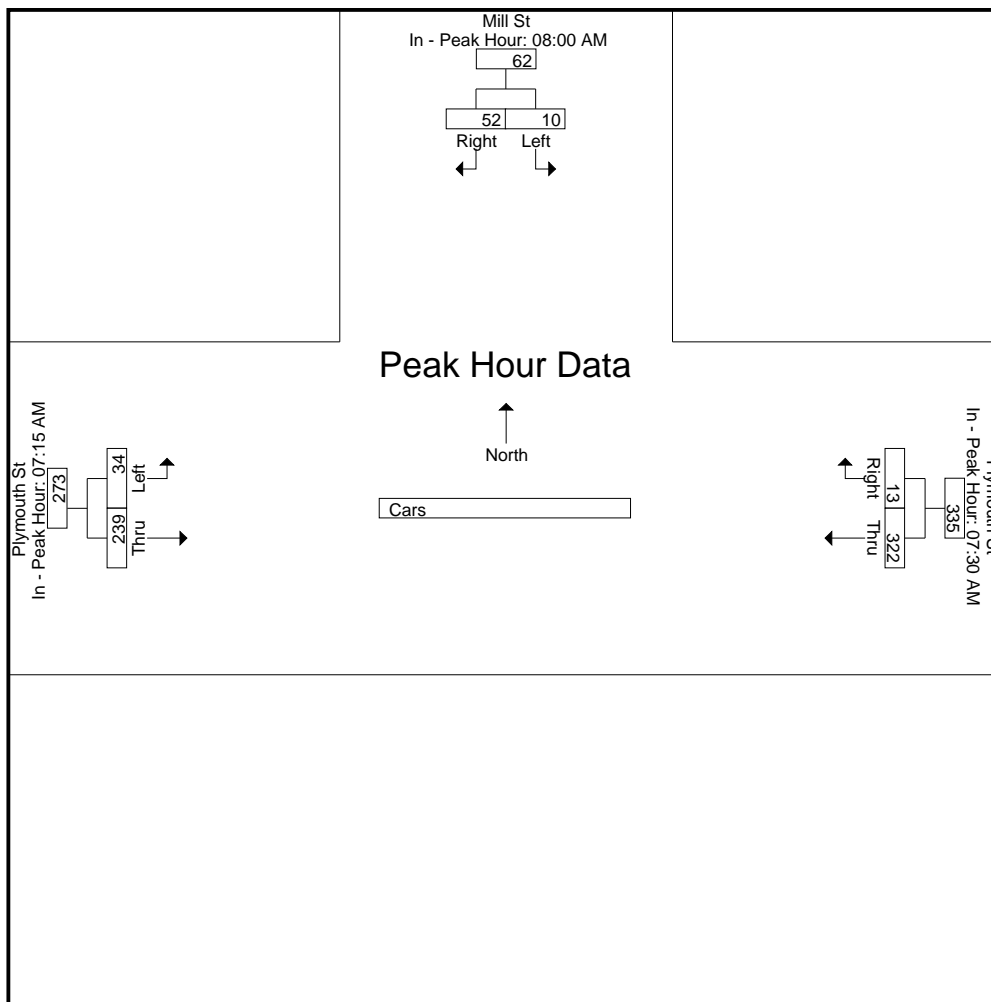

# Accurate Counts

978-664-2565

N/S Street : Mill Street  
 E/W Street : Plymouth Street  
 City/State : Bridgewater, MA  
 Weather : Clear

File Name : 20270B20  
 Site Code : 20270020  
 Start Date : 10/2/2024  
 Page No : 7

### Groups Printed- Trucks

Start Time	Mill St From North		Plymouth St From East		Plymouth St From West		Int. Total
	Left	Right	Thru	Right	Left	Thru	
07:00 AM	0	1	3	1	0	4	9
07:15 AM	0	0	1	0	1	2	4
07:30 AM	0	1	4	0	1	5	11
07:45 AM	1	1	2	1	1	2	8
<b>Total</b>	<b>1</b>	<b>3</b>	<b>10</b>	<b>2</b>	<b>3</b>	<b>13</b>	<b>32</b>
08:00 AM	1	2	5	1	1	3	13
08:15 AM	0	0	5	0	0	3	8
08:30 AM	0	0	1	1	1	8	11
08:45 AM	0	0	8	0	0	3	11
<b>Total</b>	<b>1</b>	<b>2</b>	<b>19</b>	<b>2</b>	<b>2</b>	<b>17</b>	<b>43</b>
<b>Grand Total</b>	<b>2</b>	<b>5</b>	<b>29</b>	<b>4</b>	<b>5</b>	<b>30</b>	<b>75</b>
Apprch %	28.6	71.4	87.9	12.1	14.3	85.7	
Total %	2.7	6.7	38.7	5.3	6.7	40	

Start Time	Mill St From North			Plymouth St From East			Plymouth St From West			Int. Total
	Left	Right	App. Total	Thru	Right	App. Total	Left	Thru	App. Total	
Peak Hour Analysis From 07:00 AM to 08:45 AM - Peak 1 of 1										
Peak Hour for Entire Intersection Begins at 08:00 AM										
08:00 AM	1	2	3	5	1	6	1	3	4	13
08:15 AM	0	0	0	5	0	5	0	3	3	8
08:30 AM	0	0	0	1	1	2	1	8	9	11
08:45 AM	0	0	0	8	0	8	0	3	3	11
<b>Total Volume</b>	<b>1</b>	<b>2</b>	<b>3</b>	<b>19</b>	<b>2</b>	<b>21</b>	<b>2</b>	<b>17</b>	<b>19</b>	<b>43</b>
% App. Total	33.3	66.7		90.5	9.5		10.5	89.5		
PHF	.250	.250	.250	.594	.500	.656	.500	.531	.528	.827

# Accurate Counts

978-664-2565

N/S Street : Mill Street  
 E/W Street : Plymouth Street  
 City/State : Bridgewater, MA  
 Weather : Clear

File Name : 20270B20  
 Site Code : 20270020  
 Start Date : 10/2/2024  
 Page No : 8

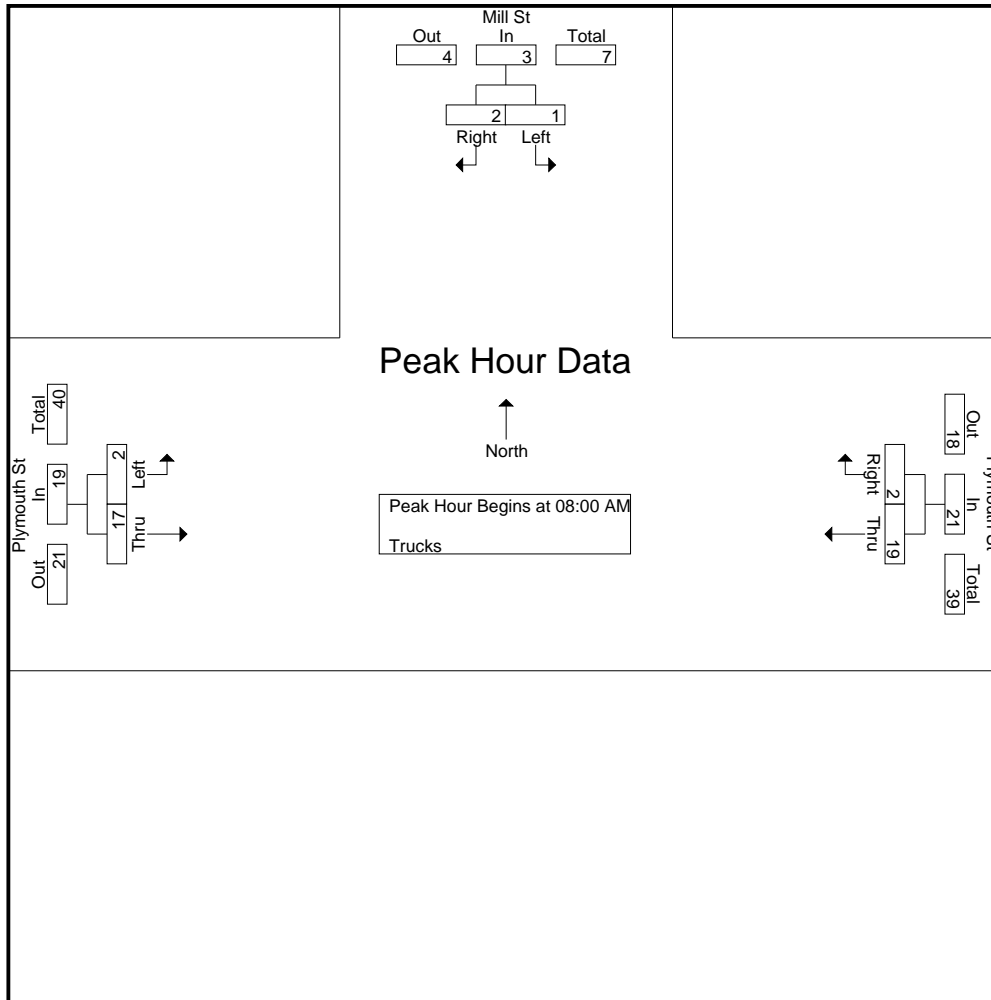

**Peak Hour Analysis From 07:00 AM to 08:45 AM - Peak 1 of 1**

Peak Hour for Each Approach Begins at:

	07:15 AM			08:00 AM			07:45 AM		
+0 mins.	0	0	0	5	1	6	1	2	3
+15 mins.	0	1	1	5	0	5	1	3	4
+30 mins.	1	1	2	1	1	2	0	3	3
+45 mins.	1	2	3	8	0	8	1	8	9
<b>Total Volume</b>	2	4	6	19	2	21	3	16	19
<b>% App. Total</b>	33.3	66.7		90.5	9.5		15.8	84.2	
<b>PHF</b>	.500	.500	.500	.594	.500	.656	.750	.500	.528



# Accurate Counts

978-664-2565

File Name : 20270B20

Site Code : 20270020

Start Date : 10/2/2024

Page No : 9

N/S Street : Mill Street  
E/W Street : Plymouth Street  
City/State : Bridgewater, MA  
Weather : Clear

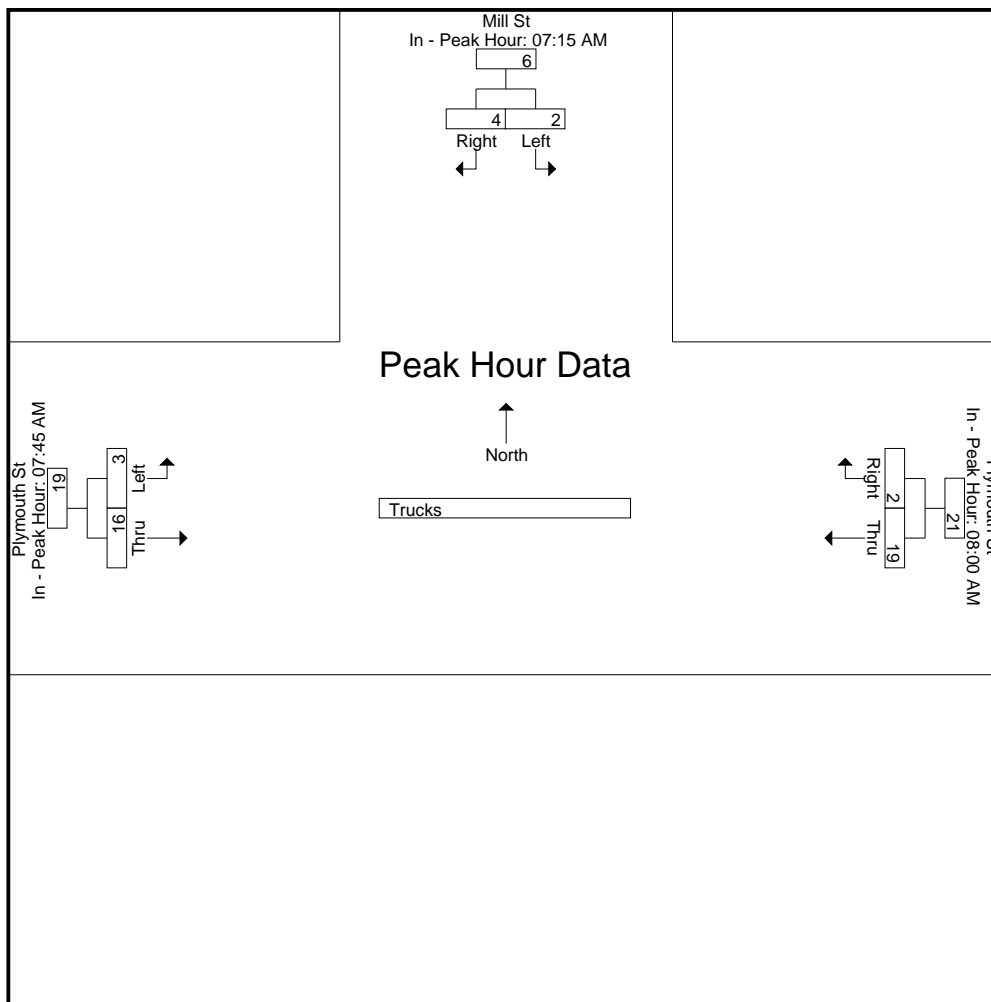

# Accurate Counts

978-664-2565

N/S Street : Mill Street  
 E/W Street : Plymouth Street  
 City/State : Bridgewater, MA  
 Weather : Clear

File Name : 20270B20  
 Site Code : 20270020  
 Start Date : 10/2/2024  
 Page No : 10

### Groups Printed- Bikes Peds

Start Time	Mill St From North			Plymouth St From East			Plymouth St From West			Exclu. Total	Inclu. Total	Int. Total
	Left	Right	Peds	Thru	Right	Peds	Left	Thru	Peds			
07:00 AM	0	0	0	0	0	0	0	0	0	0	0	0
07:15 AM	0	0	0	0	0	0	0	0	0	0	0	0
07:30 AM	0	0	0	1	0	0	0	0	0	0	1	1
07:45 AM	0	0	0	1	0	0	0	0	0	0	1	1
<b>Total</b>	0	0	0	2	0	0	0	0	0	0	2	2
08:00 AM	0	0	0	0	0	0	0	0	0	0	0	0
08:15 AM	0	0	1	0	0	0	0	0	0	1	0	1
08:30 AM	0	0	0	0	0	0	0	0	0	0	0	0
08:45 AM	0	0	0	0	0	0	0	1	0	0	1	1
<b>Total</b>	0	0	1	0	0	0	0	1	0	1	1	2
<b>Grand Total</b>	0	0	1	2	0	0	0	1	0	1	3	4
Apprch %	0	0		100	0		0	100				
Total %	0	0		66.7	0		0	33.3		25	75	

Start Time	Mill St From North			Plymouth St From East			Plymouth St From West			Int. Total
	Left	Right	App. Total	Thru	Right	App. Total	Left	Thru	App. Total	
Peak Hour Analysis From 07:00 AM to 08:45 AM - Peak 1 of 1										
Peak Hour for Entire Intersection Begins at 07:00 AM										
07:00 AM	0	0	0	0	0	0	0	0	0	0
07:15 AM	0	0	0	0	0	0	0	0	0	0
07:30 AM	0	0	0	1	0	1	0	0	0	1
07:45 AM	0	0	0	1	0	1	0	0	0	1
<b>Total Volume</b>	0	0	0	2	0	2	0	0	0	2
<b>% App. Total</b>	0	0		100	0		0	0		
<b>PHF</b>	.000	.000	.000	.500	.000	.500	.000	.000	.000	.500

# Accurate Counts

978-664-2565

File Name : 20270B20

Site Code : 20270020

Start Date : 10/2/2024

Page No : 11

N/S Street : Mill Street  
 E/W Street : Plymouth Street  
 City/State : Bridgewater, MA  
 Weather : Clear

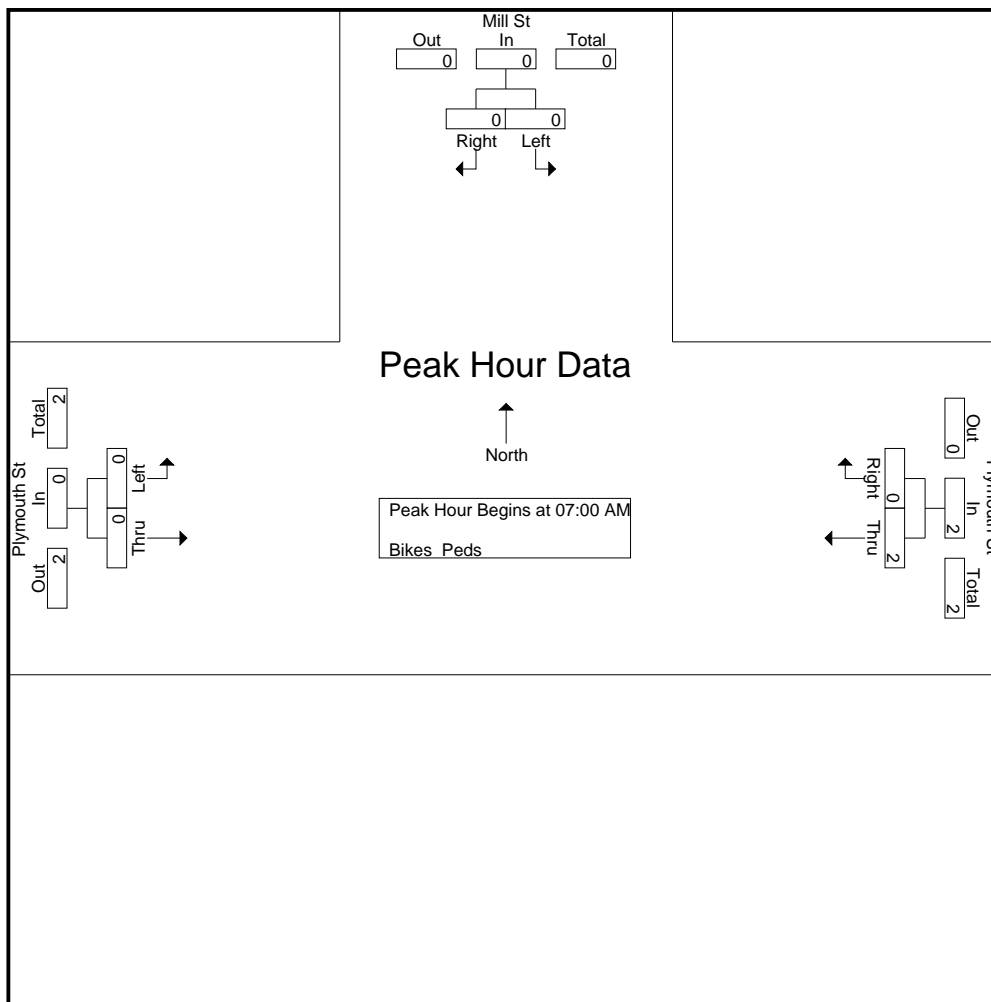

**Peak Hour Analysis From 07:00 AM to 08:45 AM - Peak 1 of 1**

Peak Hour for Each Approach Begins at:

	07:00 AM			07:00 AM			08:00 AM		
+0 mins.	0	0	0	0	0	0	0	0	0
+15 mins.	0	0	0	0	0	0	0	0	0
+30 mins.	0	0	0	1	0	1	0	0	0
+45 mins.	0	0	0	1	0	1	0	1	1
Total Volume	0	0	0	2	0	2	0	1	1
% App. Total	0	0		100	0		0	100	
PHF	.000	.000	.000	.500	.000	.500	.000	.250	.250

# Accurate Counts

978-664-2565

File Name : 20270B20

Site Code : 20270020

Start Date : 10/2/2024

Page No : 12

N/S Street : Mill Street  
E/W Street : Plymouth Street  
City/State : Bridgewater, MA  
Weather : Clear

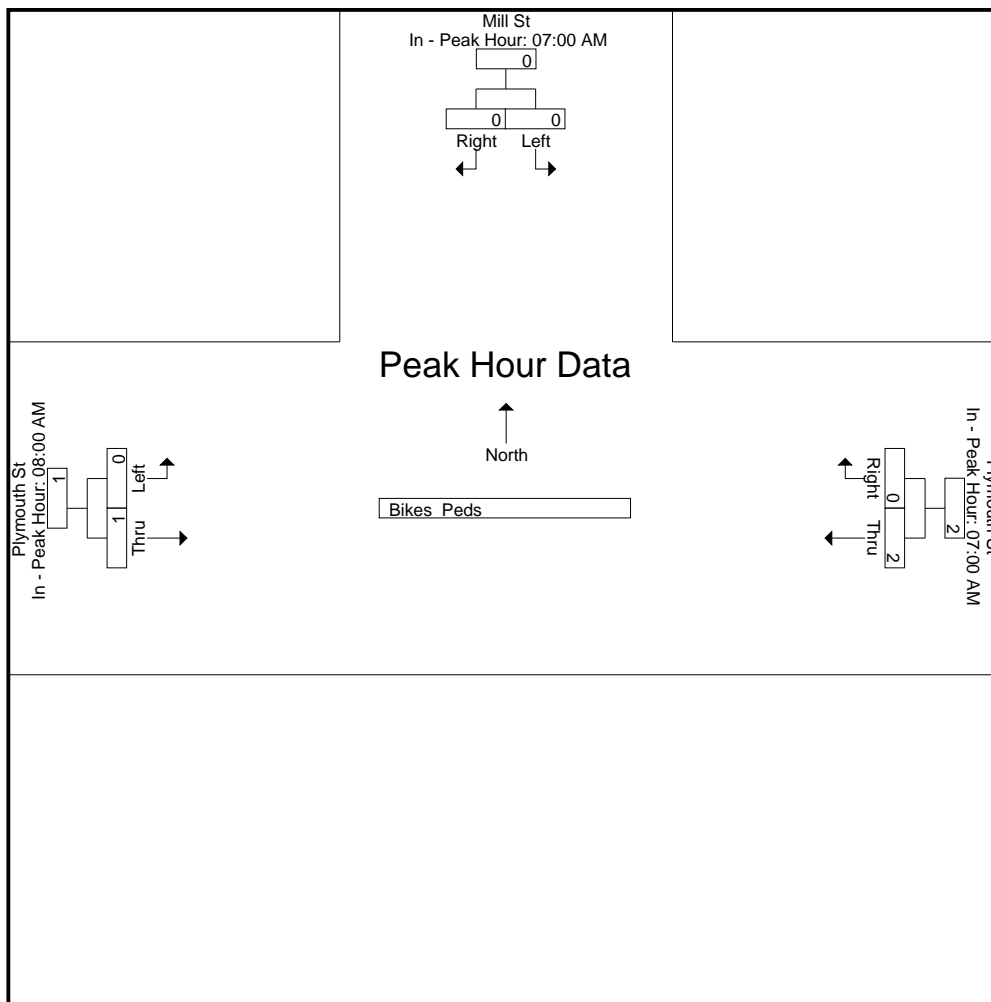

# Accurate Counts

978-664-2565

N/S Street : Mill Street  
 E/W Street : Plymouth Street  
 City/State : Bridgewater, MA  
 Weather : Clear

File Name : 20270B20  
 Site Code : 20270020  
 Start Date : 10/2/2024  
 Page No : 1

### Groups Printed- Cars - Trucks

Start Time	Mill St From North		Plymouth St From East		Plymouth St From West		Int. Total
	Left	Right	Thru	Right	Left	Thru	
04:00 PM	1	24	76	3	19	90	213
04:15 PM	2	16	96	0	14	74	202
04:30 PM	2	23	72	1	24	90	212
04:45 PM	3	17	87	4	17	104	232
<b>Total</b>	<b>8</b>	<b>80</b>	<b>331</b>	<b>8</b>	<b>74</b>	<b>358</b>	<b>859</b>
05:00 PM	2	23	97	1	11	72	206
05:15 PM	2	14	86	1	18	121	242
05:30 PM	5	18	103	0	24	71	221
05:45 PM	4	15	76	0	12	76	183
<b>Total</b>	<b>13</b>	<b>70</b>	<b>362</b>	<b>2</b>	<b>65</b>	<b>340</b>	<b>852</b>
<b>Grand Total</b>	<b>21</b>	<b>150</b>	<b>693</b>	<b>10</b>	<b>139</b>	<b>698</b>	<b>1711</b>
Apprch %	12.3	87.7	98.6	1.4	16.6	83.4	
Total %	1.2	8.8	40.5	0.6	8.1	40.8	
Cars	21	149	688	9	138	687	1692
% Cars	100	99.3	99.3	90	99.3	98.4	98.9
Trucks	0	1	5	1	1	11	19
% Trucks	0	0.7	0.7	10	0.7	1.6	1.1

Start Time	Mill St From North			Plymouth St From East			Plymouth St From West			Int. Total
	Left	Right	App. Total	Thru	Right	App. Total	Left	Thru	App. Total	
Peak Hour Analysis From 04:00 PM to 05:45 PM - Peak 1 of 1										
Peak Hour for Entire Intersection Begins at 04:45 PM										
04:45 PM	3	17	20	87	4	91	17	104	121	232
05:00 PM	2	23	25	97	1	98	11	72	83	206
05:15 PM	2	14	16	86	1	87	18	121	139	242
05:30 PM	5	18	23	103	0	103	24	71	95	221
<b>Total Volume</b>	<b>12</b>	<b>72</b>	<b>84</b>	<b>373</b>	<b>6</b>	<b>379</b>	<b>70</b>	<b>368</b>	<b>438</b>	<b>901</b>
% App. Total	14.3	85.7		98.4	1.6		16	84		
PHF	.600	.783	.840	.905	.375	.920	.729	.760	.788	.931
Cars	12	72	84	372	6	378	70	364	434	896
% Cars	100	100	100	99.7	100	99.7	100	98.9	99.1	99.4
Trucks	0	0	0	1	0	1	0	4	4	5
% Trucks	0	0	0	0.3	0	0.3	0	1.1	0.9	0.6

# Accurate Counts

978-664-2565

N/S Street : Mill Street  
 E/W Street : Plymouth Street  
 City/State : Bridgewater, MA  
 Weather : Clear

File Name : 20270B20  
 Site Code : 20270020  
 Start Date : 10/2/2024  
 Page No : 2

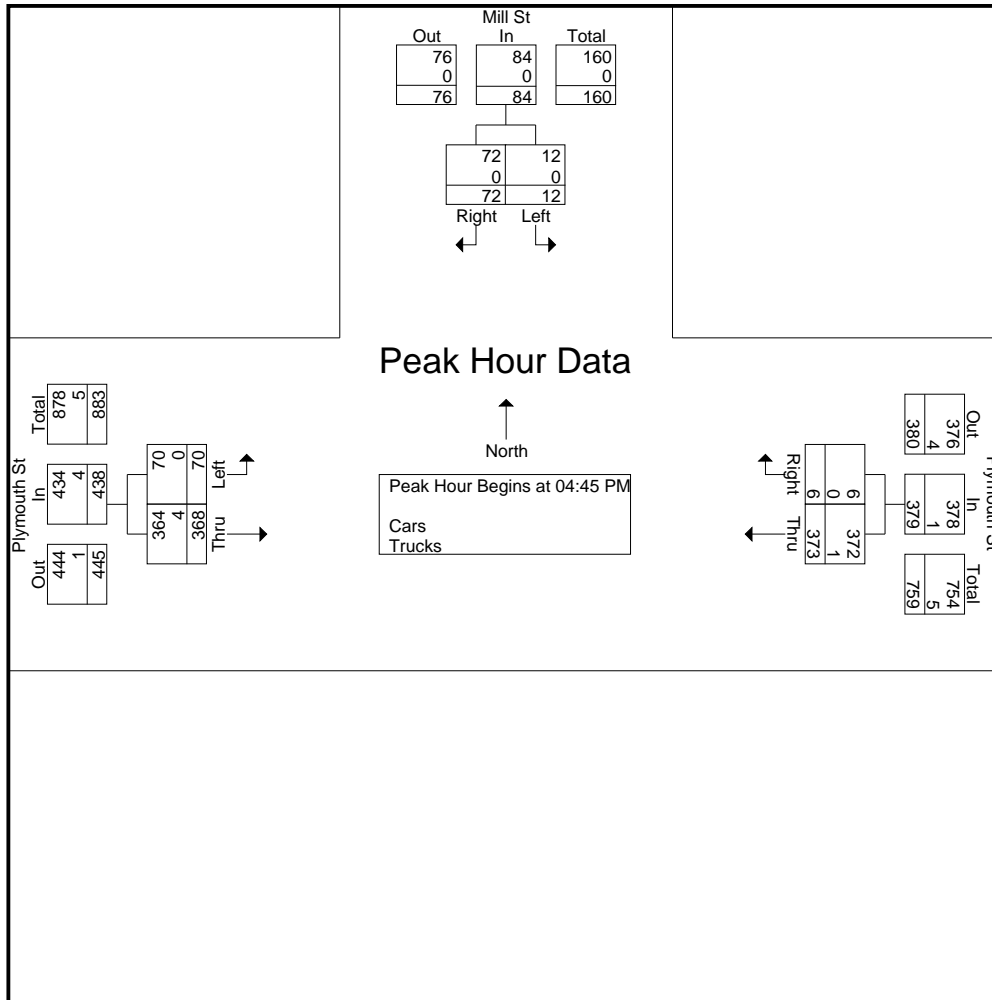

**Peak Hour Analysis From 04:00 PM to 05:45 PM - Peak 1 of 1**

Peak Hour for Each Approach Begins at:

	04:00 PM			04:45 PM			04:30 PM		
+0 mins.	1	24	25	87	4	91	24	90	114
+15 mins.	2	16	18	97	1	98	17	104	121
+30 mins.	2	23	25	86	1	87	11	72	83
+45 mins.	3	17	20	103	0	103	18	121	139
Total Volume	8	80	88	373	6	379	70	387	457
% App. Total	9.1	90.9		98.4	1.6		15.3	84.7	
PHF	.667	.833	.880	.905	.375	.920	.729	.800	.822
Cars	8	79	87	372	6	378	69	382	451
% Cars	100	98.8	98.9	99.7	100	99.7	98.6	98.7	98.7
Trucks	0	1	1	1	0	1	1	5	6
% Trucks	0	1.2	1.1	0.3	0	0.3	1.4	1.3	1.3

# Accurate Counts

978-664-2565

File Name : 20270B20

Site Code : 20270020

Start Date : 10/2/2024

Page No : 3

N/S Street : Mill Street  
 E/W Street : Plymouth Street  
 City/State : Bridgewater, MA  
 Weather : Clear

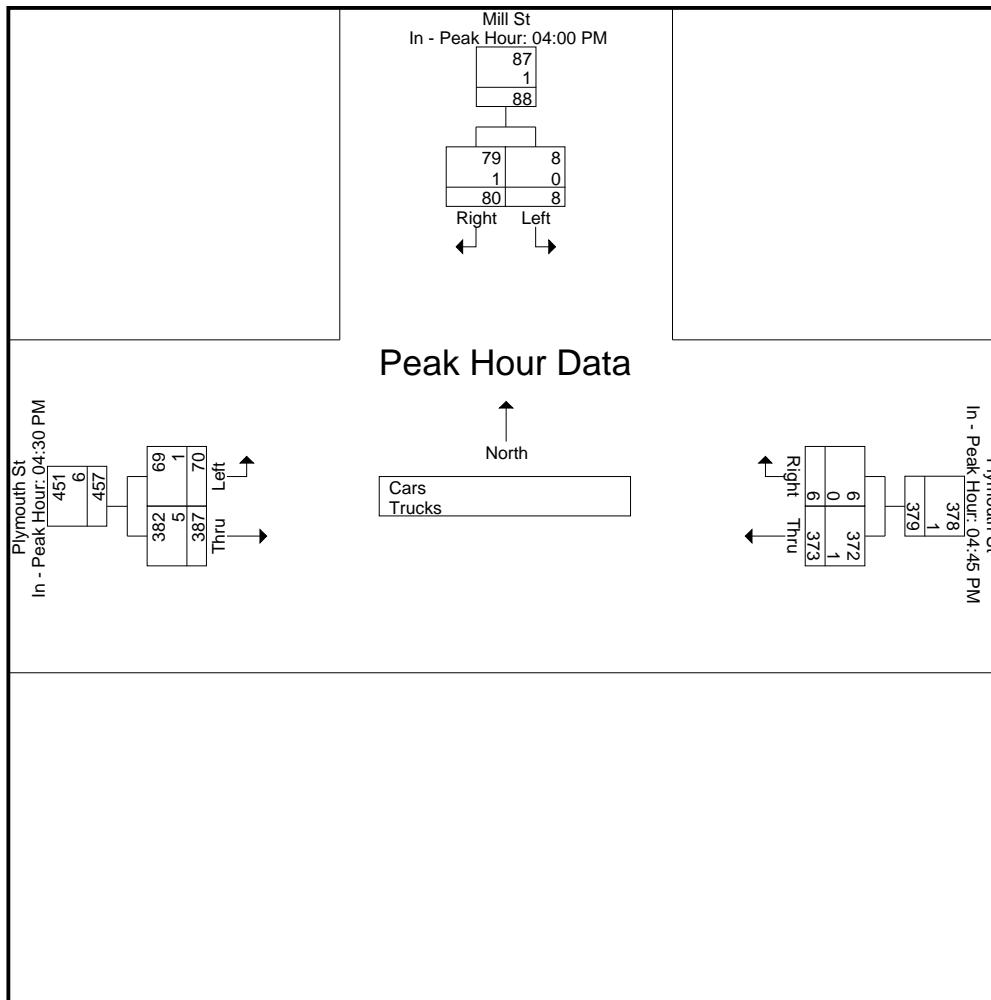

# Accurate Counts

978-664-2565

N/S Street : Mill Street  
 E/W Street : Plymouth Street  
 City/State : Bridgewater, MA  
 Weather : Clear

File Name : 20270B20  
 Site Code : 20270020  
 Start Date : 10/2/2024  
 Page No : 4

## Groups Printed- Cars

Start Time	Mill St From North		Plymouth St From East		Plymouth St From West		Int. Total
	Left	Right	Thru	Right	Left	Thru	
04:00 PM	1	23	75	2	19	84	204
04:15 PM	2	16	93	0	14	74	199
04:30 PM	2	23	72	1	23	89	210
04:45 PM	3	17	87	4	17	101	229
<b>Total</b>	<b>8</b>	<b>79</b>	<b>327</b>	<b>7</b>	<b>73</b>	<b>348</b>	<b>842</b>
05:00 PM	2	23	96	1	11	71	204
05:15 PM	2	14	86	1	18	121	242
05:30 PM	5	18	103	0	24	71	221
05:45 PM	4	15	76	0	12	76	183
<b>Total</b>	<b>13</b>	<b>70</b>	<b>361</b>	<b>2</b>	<b>65</b>	<b>339</b>	<b>850</b>
<b>Grand Total</b>	<b>21</b>	<b>149</b>	<b>688</b>	<b>9</b>	<b>138</b>	<b>687</b>	<b>1692</b>
Apprch %	12.4	87.6	98.7	1.3	16.7	83.3	
Total %	1.2	8.8	40.7	0.5	8.2	40.6	

Start Time	Mill St From North			Plymouth St From East			Plymouth St From West			Int. Total
	Left	Right	App. Total	Thru	Right	App. Total	Left	Thru	App. Total	
Peak Hour Analysis From 04:00 PM to 05:45 PM - Peak 1 of 1										
Peak Hour for Entire Intersection Begins at 04:45 PM										
04:45 PM	3	17	20	87	<b>4</b>	91	17	101	118	229
05:00 PM	2	<b>23</b>	<b>25</b>	96	1	97	11	71	82	204
05:15 PM	2	14	16	86	1	87	18	<b>121</b>	<b>139</b>	<b>242</b>
05:30 PM	<b>5</b>	18	23	<b>103</b>	0	<b>103</b>	<b>24</b>	71	95	221
Total Volume	12	72	84	372	6	378	70	364	434	896
% App. Total	14.3	85.7		98.4	1.6		16.1	83.9		
PHF	.600	.783	.840	.903	.375	.917	.729	.752	.781	.926



# Accurate Counts

978-664-2565

File Name : 20270B20

Site Code : 20270020

Start Date : 10/2/2024

Page No : 5

N/S Street : Mill Street  
 E/W Street : Plymouth Street  
 City/State : Bridgewater, MA  
 Weather : Clear

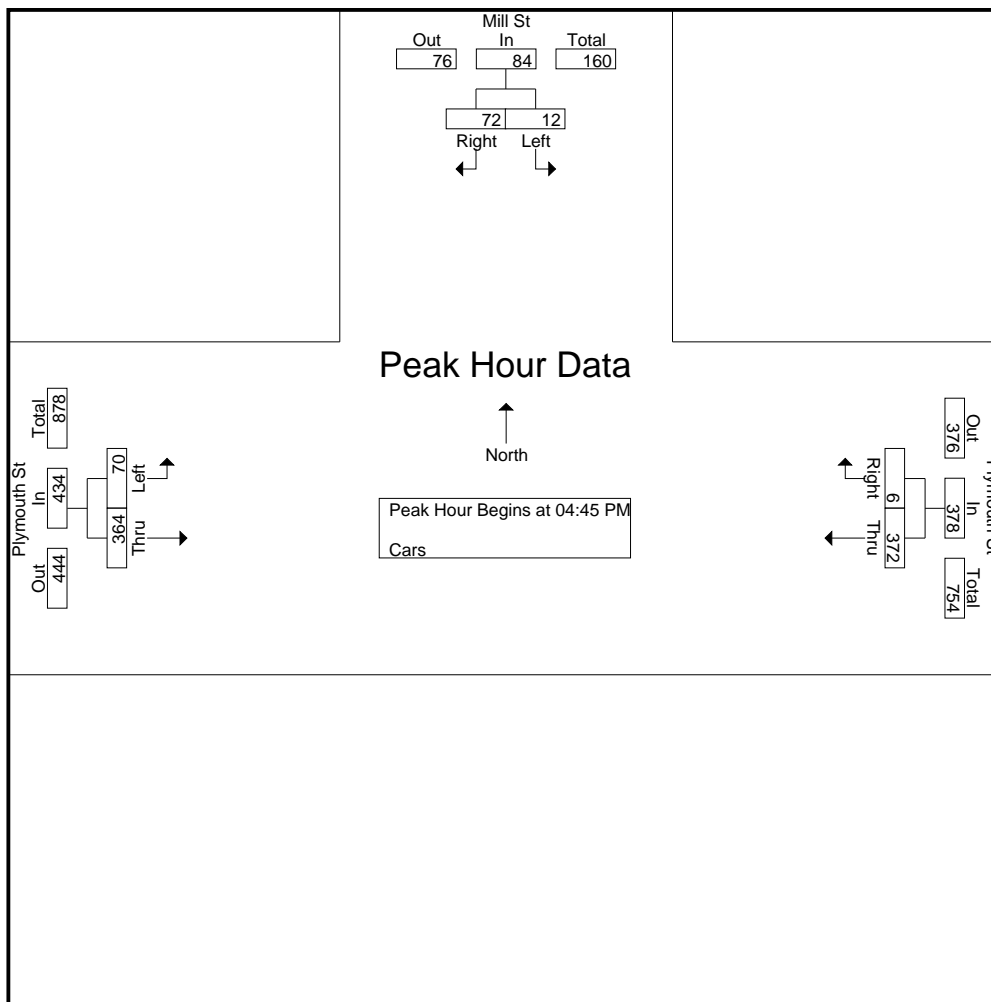

**Peak Hour Analysis From 04:00 PM to 05:45 PM - Peak 1 of 1**

Peak Hour for Each Approach Begins at:

	04:15 PM			04:45 PM			04:30 PM		
+0 mins.	2	16	18	87	4	91	23	89	112
+15 mins.	2	23	25	96	1	97	17	101	118
+30 mins.	3	17	20	86	1	87	11	71	82
+45 mins.	2	23	25	103	0	103	18	121	139
Total Volume	9	79	88	372	6	378	69	382	451
% App. Total	10.2	89.8		98.4	1.6		15.3	84.7	
PHF	.750	.859	.880	.903	.375	.917	.750	.789	.811

# Accurate Counts

978-664-2565

File Name : 20270B20

Site Code : 20270020

Start Date : 10/2/2024

Page No : 6

N/S Street : Mill Street  
E/W Street : Plymouth Street  
City/State : Bridgewater, MA  
Weather : Clear

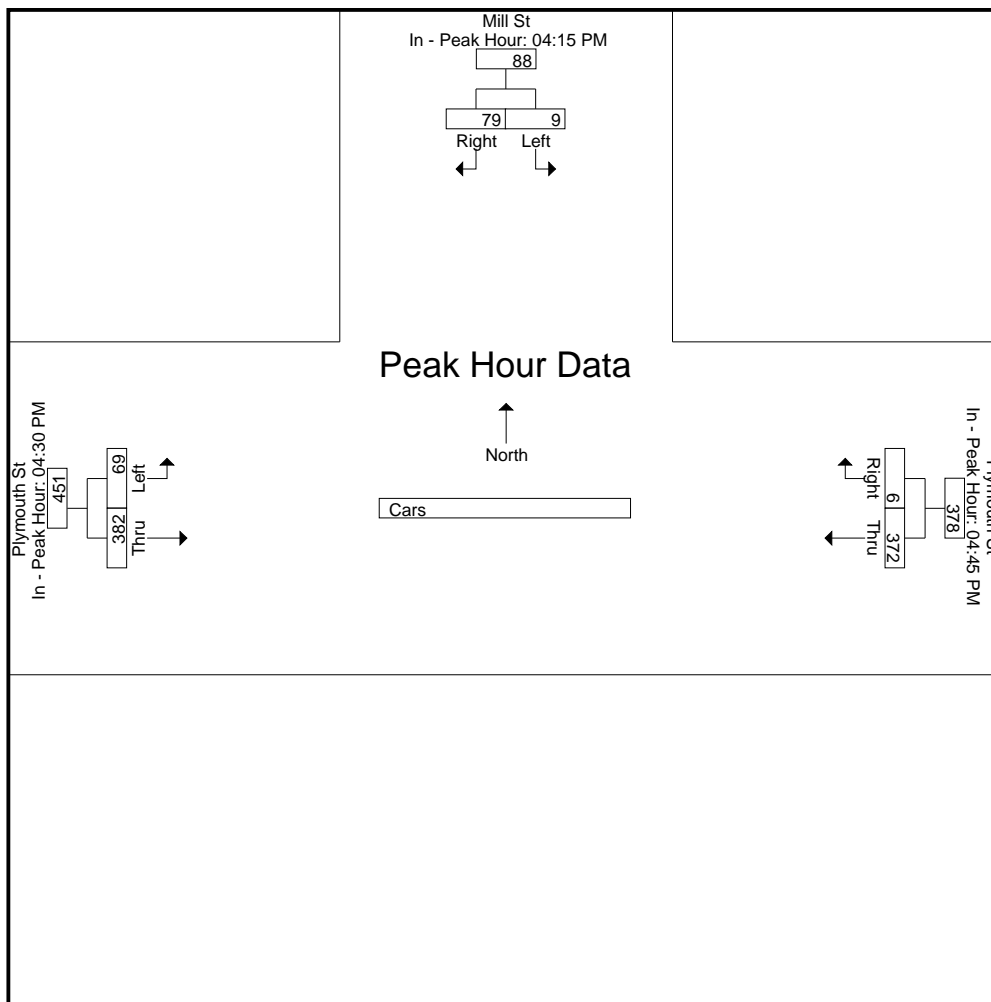

# Accurate Counts

978-664-2565

N/S Street : Mill Street  
 E/W Street : Plymouth Street  
 City/State : Bridgewater, MA  
 Weather : Clear

File Name : 20270B20  
 Site Code : 20270020  
 Start Date : 10/2/2024  
 Page No : 7

### Groups Printed- Trucks

Start Time	Mill St From North		Plymouth St From East		Plymouth St From West		Int. Total
	Left	Right	Thru	Right	Left	Thru	
04:00 PM	0	1	1	1	0	6	9
04:15 PM	0	0	3	0	0	0	3
04:30 PM	0	0	0	0	1	1	2
04:45 PM	0	0	0	0	0	3	3
<b>Total</b>	<b>0</b>	<b>1</b>	<b>4</b>	<b>1</b>	<b>1</b>	<b>10</b>	<b>17</b>
05:00 PM	0	0	1	0	0	1	2
05:15 PM	0	0	0	0	0	0	0
05:30 PM	0	0	0	0	0	0	0
05:45 PM	0	0	0	0	0	0	0
<b>Total</b>	<b>0</b>	<b>0</b>	<b>1</b>	<b>0</b>	<b>0</b>	<b>1</b>	<b>2</b>
<b>Grand Total</b>	<b>0</b>	<b>1</b>	<b>5</b>	<b>1</b>	<b>1</b>	<b>11</b>	<b>19</b>
Apprch %	0	100	83.3	16.7	8.3	91.7	
Total %	0	5.3	26.3	5.3	5.3	57.9	

Start Time	Mill St From North			Plymouth St From East			Plymouth St From West			Int. Total
	Left	Right	App. Total	Thru	Right	App. Total	Left	Thru	App. Total	
Peak Hour Analysis From 04:00 PM to 05:45 PM - Peak 1 of 1										
Peak Hour for Entire Intersection Begins at 04:00 PM										
04:00 PM	0	1	1	1	1	2	0	6	6	9
04:15 PM	0	0	0	3	0	3	0	0	0	3
04:30 PM	0	0	0	0	0	0	1	1	2	2
04:45 PM	0	0	0	0	0	0	0	3	3	3
<b>Total Volume</b>	<b>0</b>	<b>1</b>	<b>1</b>	<b>4</b>	<b>1</b>	<b>5</b>	<b>1</b>	<b>10</b>	<b>11</b>	<b>17</b>
% App. Total	0	100		80	20		9.1	90.9		
PHF	.000	.250	.250	.333	.250	.417	.250	.417	.458	.472

# Accurate Counts

978-664-2565

File Name : 20270B20

Site Code : 20270020

Start Date : 10/2/2024

Page No : 8

N/S Street : Mill Street  
 E/W Street : Plymouth Street  
 City/State : Bridgewater, MA  
 Weather : Clear

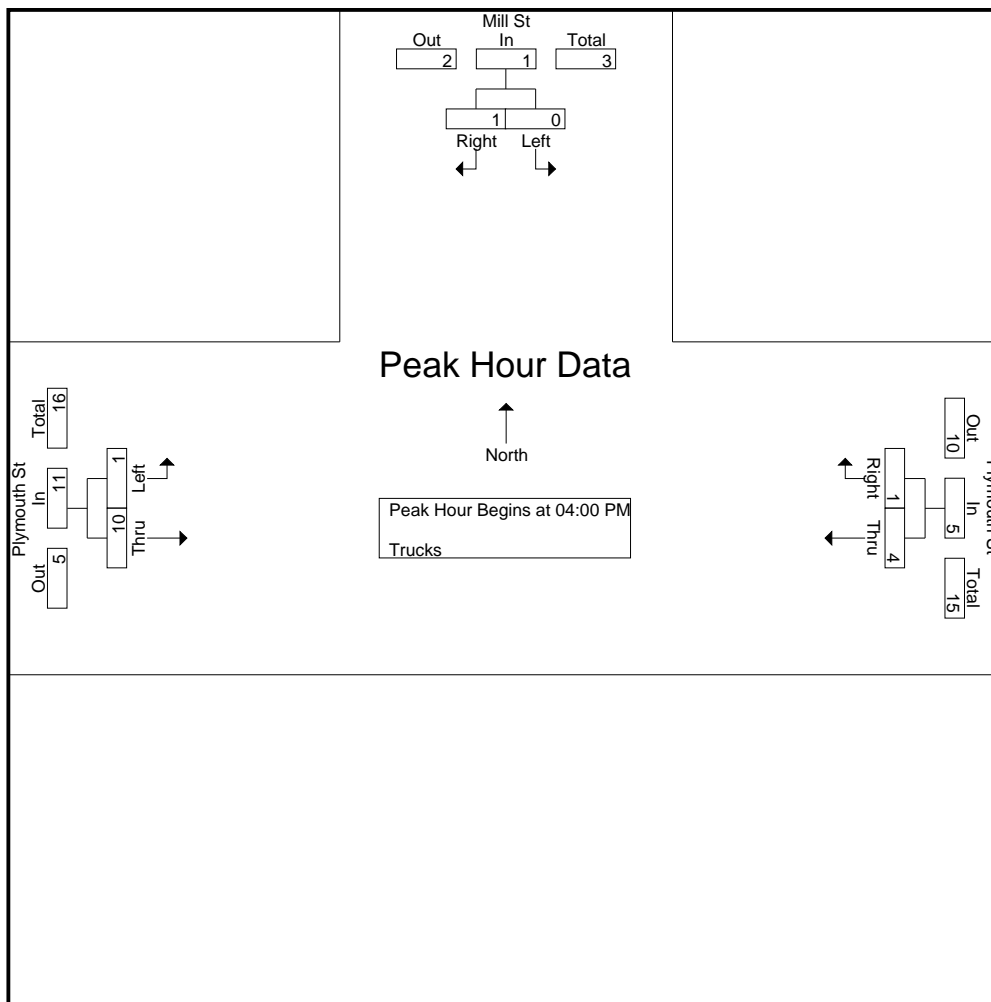

**Peak Hour Analysis From 04:00 PM to 05:45 PM - Peak 1 of 1**

Peak Hour for Each Approach Begins at:

	04:00 PM			04:00 PM			04:00 PM		
+0 mins.	0	1	1	1	1	2	0	6	6
+15 mins.	0	0	0	3	0	3	0	0	0
+30 mins.	0	0	0	0	0	0	1	1	2
+45 mins.	0	0	0	0	0	0	0	3	3
Total Volume	0	1	1	4	1	5	1	10	11
% App. Total	0	100		80	20		9.1	90.9	
PHF	.000	.250	.250	.333	.250	.417	.250	.417	.458

# Accurate Counts

978-664-2565

File Name : 20270B20

Site Code : 20270020

Start Date : 10/2/2024

Page No : 9

N/S Street : Mill Street  
E/W Street : Plymouth Street  
City/State : Bridgewater, MA  
Weather : Clear

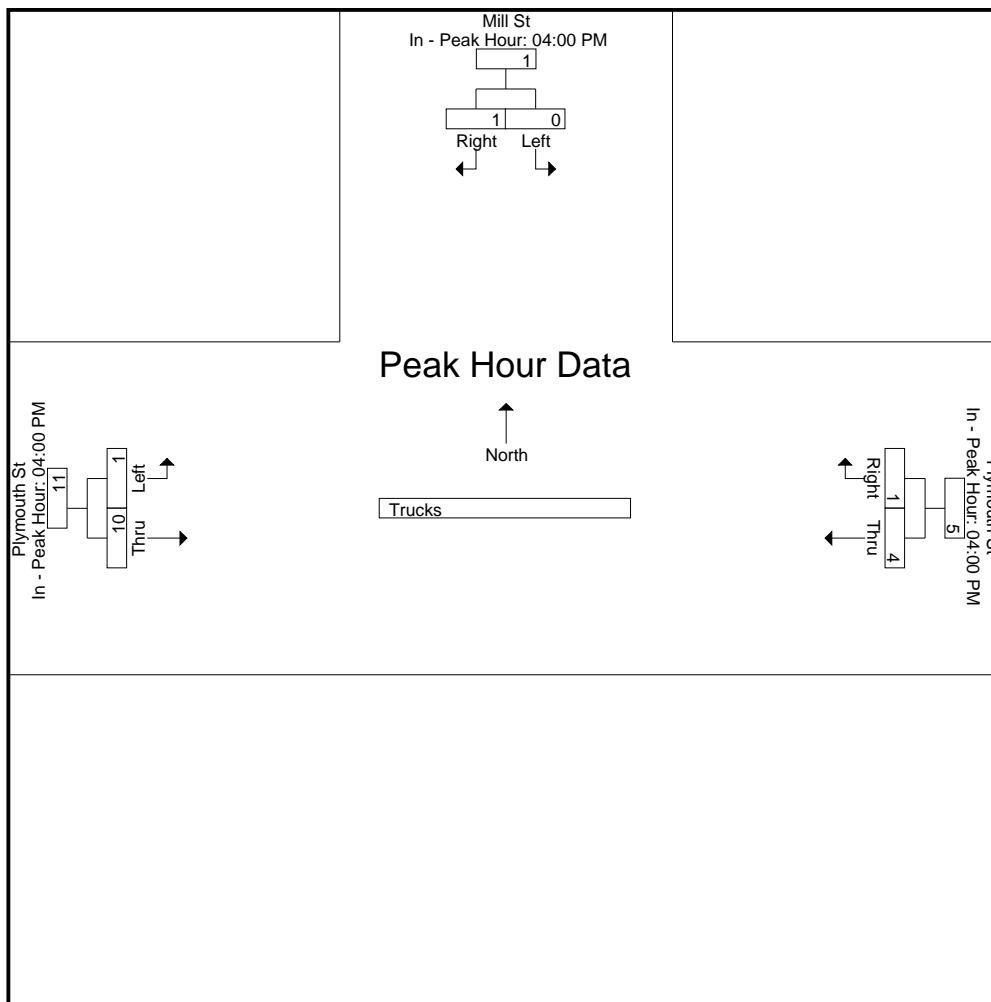

# Accurate Counts

978-664-2565

N/S Street : Mill Street  
 E/W Street : Plymouth Street  
 City/State : Bridgewater, MA  
 Weather : Clear

File Name : 20270B20  
 Site Code : 20270020  
 Start Date : 10/2/2024  
 Page No : 10

### Groups Printed- Bikes Peds

Start Time	Mill St From North			Plymouth St From East			Plymouth St From West			Exclu. Total	Inclu. Total	Int. Total
	Left	Right	Peds	Thru	Right	Peds	Left	Thru	Peds			
04:00 PM	0	0	0	0	0	0	0	1	0	0	1	1
04:15 PM	0	0	0	0	0	0	0	0	0	0	0	0
04:30 PM	0	0	0	0	0	0	0	0	0	0	0	0
04:45 PM	0	0	0	0	0	0	0	0	0	0	0	0
<b>Total</b>	0	0	0	0	0	0	0	1	0	0	1	1
05:00 PM	0	0	0	0	0	0	0	0	0	0	0	0
05:15 PM	0	0	0	0	0	0	0	0	0	0	0	0
05:30 PM	0	0	0	0	0	0	0	0	0	0	0	0
05:45 PM	0	0	0	0	0	0	0	0	0	0	0	0
<b>Total</b>	0	0	0	0	0	0	0	0	0	0	0	0
<b>Grand Total</b>	0	0	0	0	0	0	0	1	0	0	1	1
Apprch %	0	0		0	0		0	100				
Total %	0	0		0	0		0	100		0	100	

Start Time	Mill St From North			Plymouth St From East			Plymouth St From West			Int. Total
	Left	Right	App. Total	Thru	Right	App. Total	Left	Thru	App. Total	
Peak Hour Analysis From 04:00 PM to 05:45 PM - Peak 1 of 1										
Peak Hour for Entire Intersection Begins at 04:00 PM										
04:00 PM	0	0	0	0	0	0	0	1	1	1
04:15 PM	0	0	0	0	0	0	0	0	0	0
04:30 PM	0	0	0	0	0	0	0	0	0	0
04:45 PM	0	0	0	0	0	0	0	0	0	0
<b>Total Volume</b>	0	0	0	0	0	0	0	1	1	1
<b>% App. Total</b>	0	0		0	0		0	100		
<b>PHF</b>	.000	.000	.000	.000	.000	.000	.000	.250	.250	.250

# Accurate Counts

978-664-2565

N/S Street : Mill Street  
 E/W Street : Plymouth Street  
 City/State : Bridgewater, MA  
 Weather : Clear

File Name : 20270B20  
 Site Code : 20270020  
 Start Date : 10/2/2024  
 Page No : 11

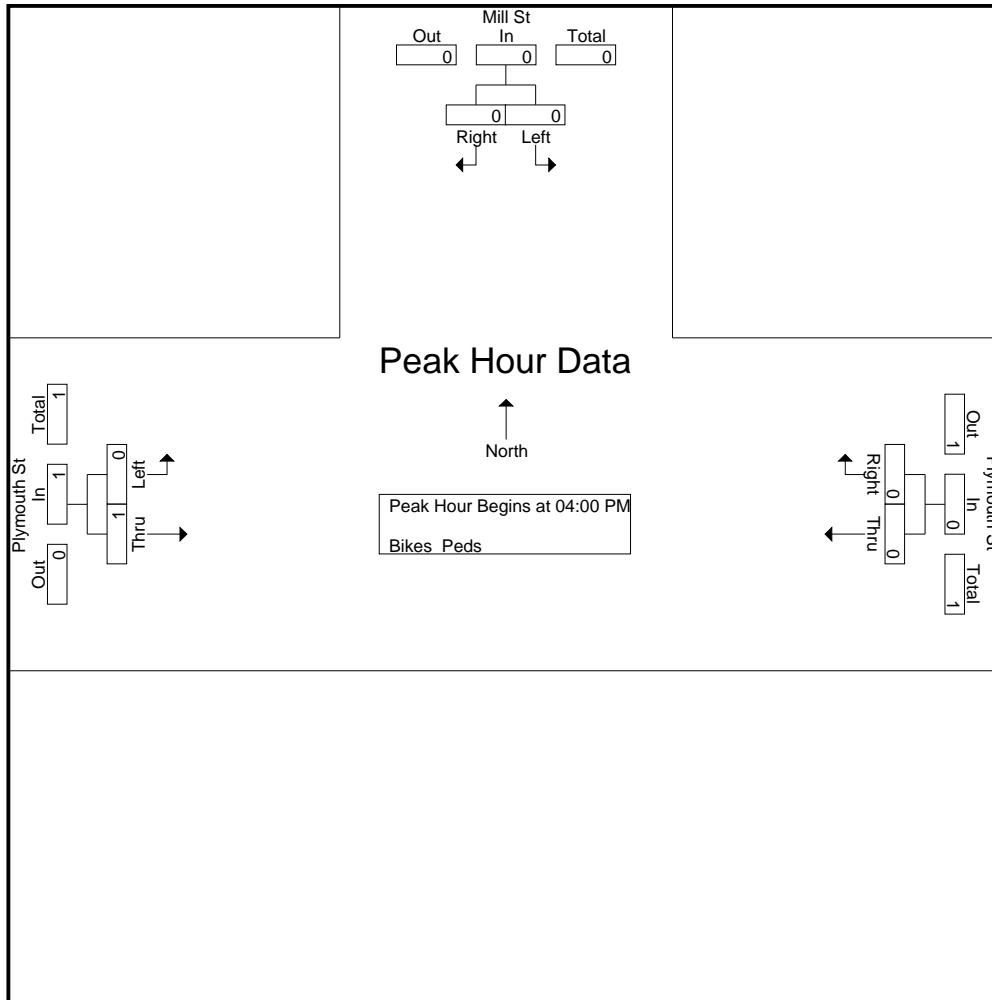

**Peak Hour Analysis From 04:00 PM to 05:45 PM - Peak 1 of 1**

Peak Hour for Each Approach Begins at:

	04:00 PM			04:00 PM			04:00 PM		
+0 mins.	0	0	0	0	0	0	0	1	1
+15 mins.	0	0	0	0	0	0	0	0	0
+30 mins.	0	0	0	0	0	0	0	0	0
+45 mins.	0	0	0	0	0	0	0	0	0
Total Volume	0	0	0	0	0	0	0	1	1
% App. Total	0	0	0	0	0	0	0	100	100
PHF	.000	.000	.000	.000	.000	.000	.000	.250	.250

# Accurate Counts

978-664-2565

File Name : 20270B20

Site Code : 20270020

Start Date : 10/2/2024

Page No : 12

N/S Street : Mill Street  
E/W Street : Plymouth Street  
City/State : Bridgewater, MA  
Weather : Clear

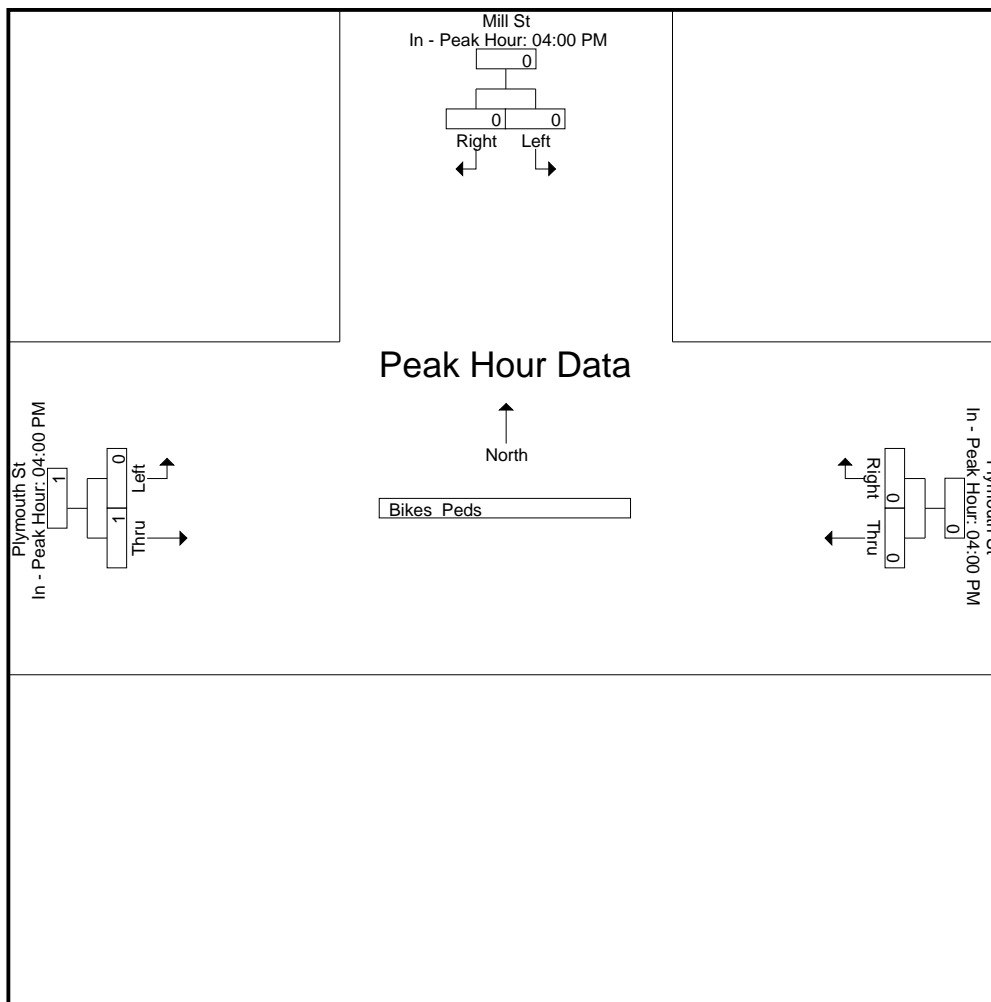



# Accurate Counts

978-664-2565

N/S Street : High Street  
 E/W Street : Plymouth Street  
 City/State : Bridgewater, MA  
 Weather : Clear

File Name : 20270B21  
 Site Code : 20270021  
 Start Date : 10/2/2024  
 Page No : 1

### Groups Printed- Cars - Trucks

Start Time	High St From North		Plymouth St From East		Plymouth St From West		Int. Total
	Left	Right	Thru	Right	Left	Thru	
07:00 AM	3	0	54	16	0	61	134
07:15 AM	10	0	78	10	0	64	162
07:30 AM	12	4	95	15	0	63	189
07:45 AM	4	1	90	11	1	69	176
<b>Total</b>	<b>29</b>	<b>5</b>	<b>317</b>	<b>52</b>	<b>1</b>	<b>257</b>	<b>661</b>
08:00 AM	11	0	70	11	3	65	160
08:15 AM	4	0	89	17	0	56	166
08:30 AM	9	1	84	11	0	51	156
08:45 AM	5	1	72	13	1	38	130
<b>Total</b>	<b>29</b>	<b>2</b>	<b>315</b>	<b>52</b>	<b>4</b>	<b>210</b>	<b>612</b>
<b>Grand Total</b>	<b>58</b>	<b>7</b>	<b>632</b>	<b>104</b>	<b>5</b>	<b>467</b>	<b>1273</b>
Apprch %	89.2	10.8	85.9	14.1	1.1	98.9	
Total %	4.6	0.5	49.6	8.2	0.4	36.7	
Cars	58	5	596	101	4	428	1192
% Cars	100	71.4	94.3	97.1	80	91.6	93.6
Trucks	0	2	36	3	1	39	81
% Trucks	0	28.6	5.7	2.9	20	8.4	6.4

Start Time	High St From North			Plymouth St From East			Plymouth St From West			Int. Total
	Left	Right	App. Total	Thru	Right	App. Total	Left	Thru	App. Total	
Peak Hour Analysis From 07:00 AM to 08:45 AM - Peak 1 of 1										
Peak Hour for Entire Intersection Begins at 07:30 AM										
07:30 AM	<b>12</b>	<b>4</b>	<b>16</b>	<b>95</b>	<b>15</b>	<b>110</b>	<b>0</b>	<b>63</b>	<b>63</b>	<b>189</b>
07:45 AM	4	1	5	90	11	101	1	<b>69</b>	<b>70</b>	176
08:00 AM	11	0	11	70	11	81	<b>3</b>	65	68	160
08:15 AM	4	0	4	89	<b>17</b>	106	0	56	56	166
Total Volume	31	5	36	344	54	398	4	253	257	691
% App. Total	86.1	13.9		86.4	13.6		1.6	98.4		
PHF	.646	.313	.563	.905	.794	.905	.333	.917	.918	.914
Cars	31	3	34	325	53	378	3	235	238	650
% Cars	100	60.0	94.4	94.5	98.1	95.0	75.0	92.9	92.6	94.1
Trucks	0	2	2	19	1	20	1	18	19	41
% Trucks	0	40.0	5.6	5.5	1.9	5.0	25.0	7.1	7.4	5.9

# Accurate Counts

978-664-2565

N/S Street : High Street  
 E/W Street : Plymouth Street  
 City/State : Bridgewater, MA  
 Weather : Clear

File Name : 20270B21  
 Site Code : 20270021  
 Start Date : 10/2/2024  
 Page No : 2

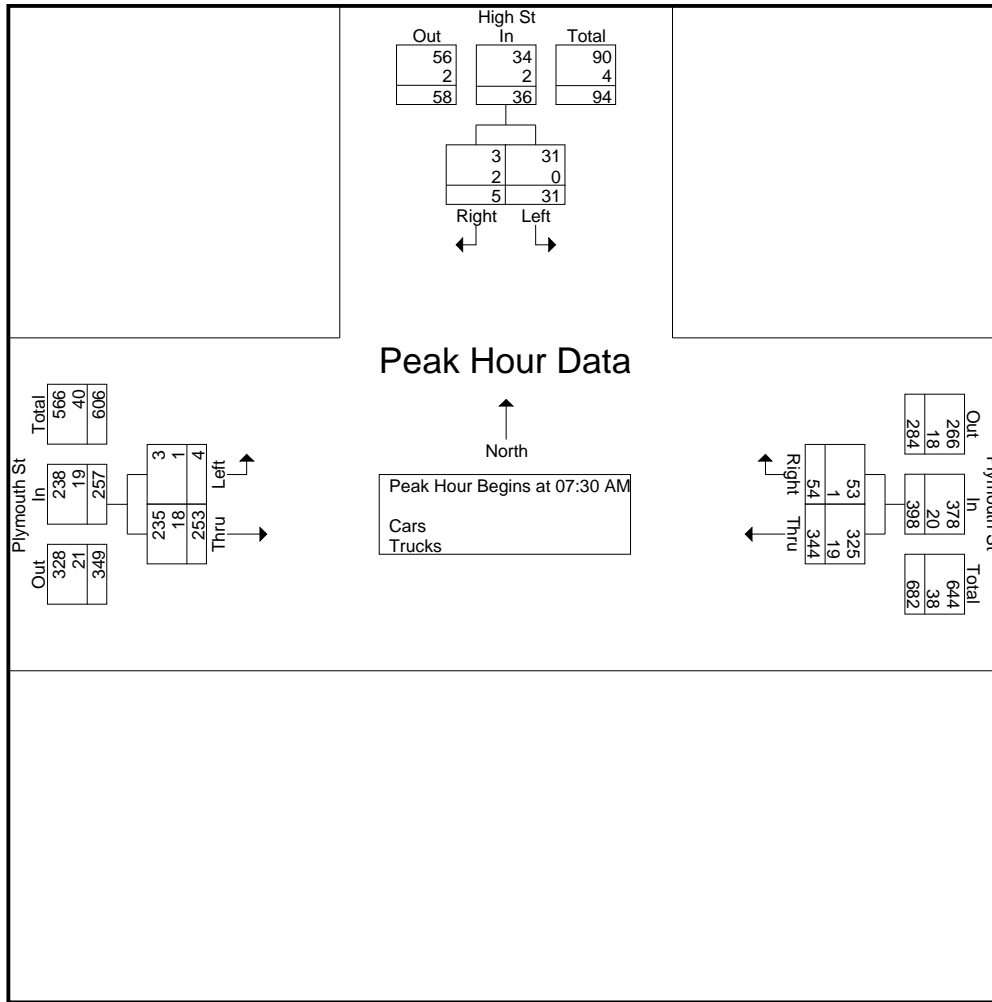

**Peak Hour Analysis From 07:00 AM to 08:45 AM - Peak 1 of 1**

Peak Hour for Each Approach Begins at:

	07:15 AM			07:30 AM			07:15 AM		
+0 mins.	10	0	10	<b>95</b>	15	<b>110</b>	0	64	64
+15 mins.	<b>12</b>	<b>4</b>	<b>16</b>	90	11	101	0	63	63
+30 mins.	4	1	5	70	11	81	1	<b>69</b>	<b>70</b>
+45 mins.	11	0	11	89	<b>17</b>	106	<b>3</b>	65	68
Total Volume	37	5	42	344	54	398	4	261	265
% App. Total	88.1	11.9		86.4	13.6		1.5	98.5	
PHF	.771	.313	.656	.905	.794	.905	.333	.946	.946
Cars	37	3	40	325	53	378	3	244	247
% Cars	100	60	95.2	94.5	98.1	95	75	93.5	93.2
Trucks	0	2	2	19	1	20	1	17	18
% Trucks	0	40	4.8	5.5	1.9	5	25	6.5	6.8

# Accurate Counts

978-664-2565

File Name : 20270B21

Site Code : 20270021

Start Date : 10/2/2024

Page No : 3

N/S Street : High Street

E/W Street : Plymouth Street

City/State : Bridgewater, MA

Weather : Clear

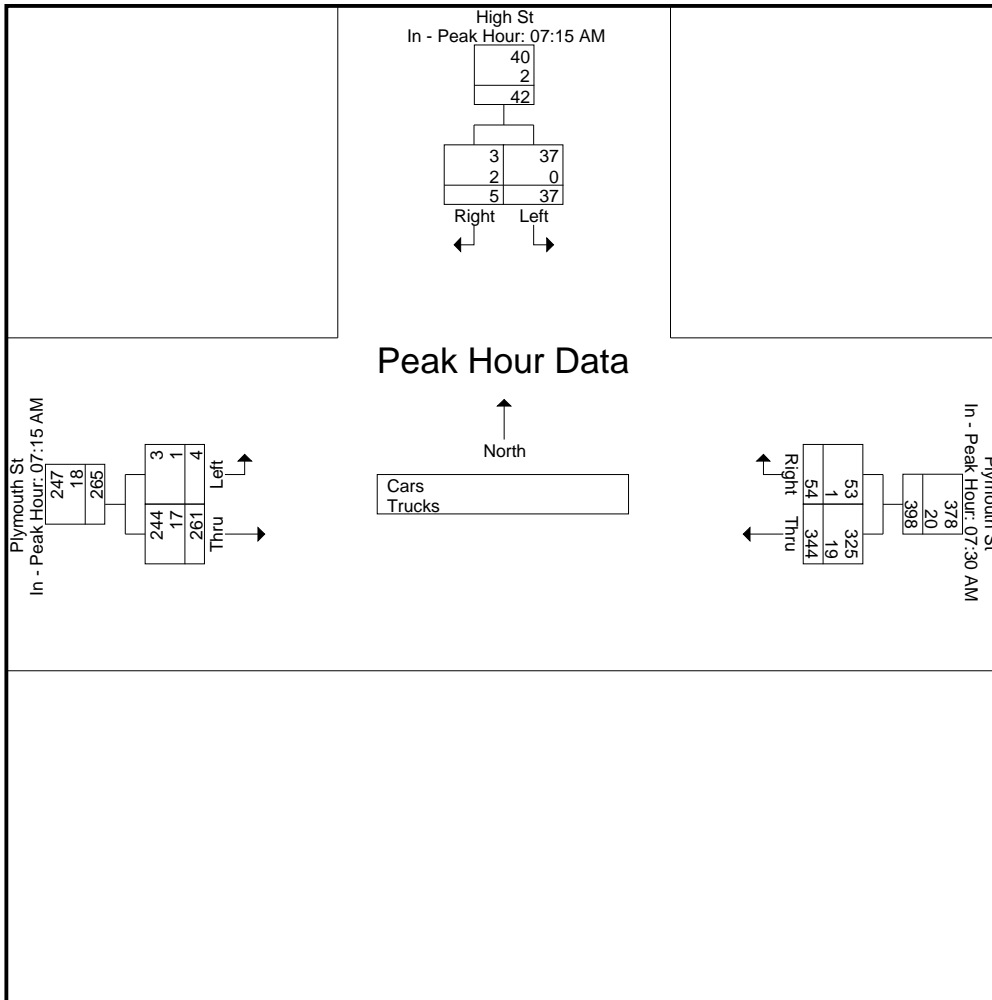

# Accurate Counts

978-664-2565

N/S Street : High Street  
 E/W Street : Plymouth Street  
 City/State : Bridgewater, MA  
 Weather : Clear

File Name : 20270B21  
 Site Code : 20270021  
 Start Date : 10/2/2024  
 Page No : 4

## Groups Printed- Cars

Start Time	High St From North		Plymouth St From East		Plymouth St From West		Int. Total
	Left	Right	Thru	Right	Left	Thru	
07:00 AM	3	0	52	15	0	56	126
07:15 AM	10	0	74	10	0	59	153
07:30 AM	12	2	93	15	0	59	181
07:45 AM	4	1	83	11	0	64	163
<b>Total</b>	<b>29</b>	<b>3</b>	<b>302</b>	<b>51</b>	<b>0</b>	<b>238</b>	<b>623</b>
08:00 AM	11	0	62	11	3	62	149
08:15 AM	4	0	87	16	0	50	157
08:30 AM	9	1	82	10	0	45	147
08:45 AM	5	1	63	13	1	33	116
<b>Total</b>	<b>29</b>	<b>2</b>	<b>294</b>	<b>50</b>	<b>4</b>	<b>190</b>	<b>569</b>
<b>Grand Total</b>	<b>58</b>	<b>5</b>	<b>596</b>	<b>101</b>	<b>4</b>	<b>428</b>	<b>1192</b>
Apprch %	92.1	7.9	85.5	14.5	0.9	99.1	
Total %	4.9	0.4	50	8.5	0.3	35.9	

Start Time	High St From North			Plymouth St From East			Plymouth St From West			Int. Total
	Left	Right	App. Total	Thru	Right	App. Total	Left	Thru	App. Total	
Peak Hour Analysis From 07:00 AM to 08:45 AM - Peak 1 of 1										
Peak Hour for Entire Intersection Begins at 07:30 AM										
07:30 AM	<b>12</b>	<b>2</b>	<b>14</b>	<b>93</b>	15	<b>108</b>	0	59	59	<b>181</b>
07:45 AM	4	1	5	83	11	94	0	<b>64</b>	64	163
08:00 AM	11	0	11	62	11	73	<b>3</b>	62	<b>65</b>	149
08:15 AM	4	0	4	87	<b>16</b>	103	0	50	50	157
<b>Total Volume</b>	<b>31</b>	<b>3</b>	<b>34</b>	<b>325</b>	<b>53</b>	<b>378</b>	<b>3</b>	<b>235</b>	<b>238</b>	<b>650</b>
% App. Total	91.2	8.8		86	14		1.3	98.7		
PHF	.646	.375	.607	.874	.828	.875	.250	.918	.915	.898

# Accurate Counts

978-664-2565

File Name : 20270B21

Site Code : 20270021

Start Date : 10/2/2024

Page No : 5

N/S Street : High Street  
 E/W Street : Plymouth Street  
 City/State : Bridgewater, MA  
 Weather : Clear

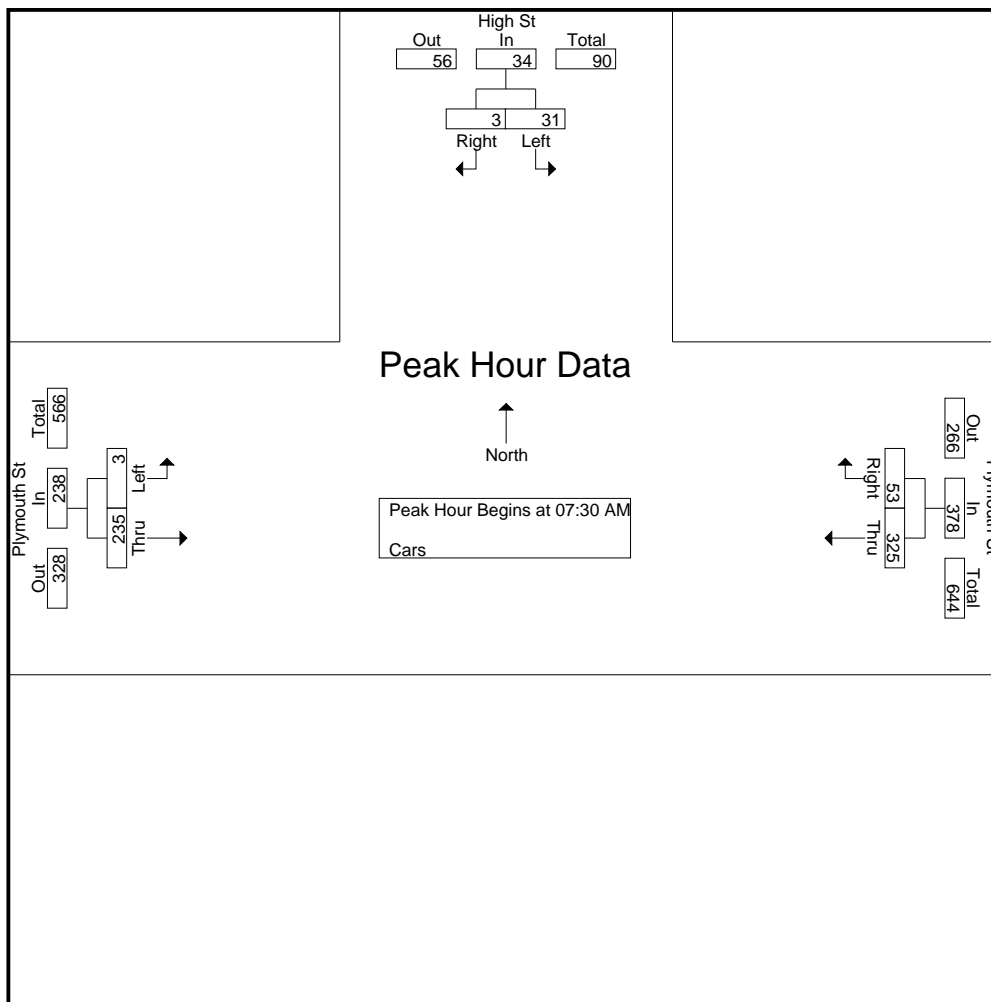

**Peak Hour Analysis From 07:00 AM to 08:45 AM - Peak 1 of 1**

Peak Hour for Each Approach Begins at:

	07:15 AM			07:30 AM			07:45 AM		
+0 mins.	10	0	10	<b>93</b>	15	<b>108</b>	0	59	59
+15 mins.	<b>12</b>	<b>2</b>	<b>14</b>	83	11	94	0	59	59
+30 mins.	4	1	5	62	11	73	0	<b>64</b>	64
+45 mins.	11	0	11	87	<b>16</b>	103	<b>3</b>	62	<b>65</b>
Total Volume	37	3	40	325	53	378	3	244	247
% App. Total	92.5	7.5		86	14		1.2	98.8	
PHF	.771	.375	.714	.874	.828	.875	.250	.953	.950

# Accurate Counts

978-664-2565

File Name : 20270B21

Site Code : 20270021

Start Date : 10/2/2024

Page No : 6

N/S Street : High Street  
E/W Street : Plymouth Street  
City/State : Bridgewater, MA  
Weather : Clear

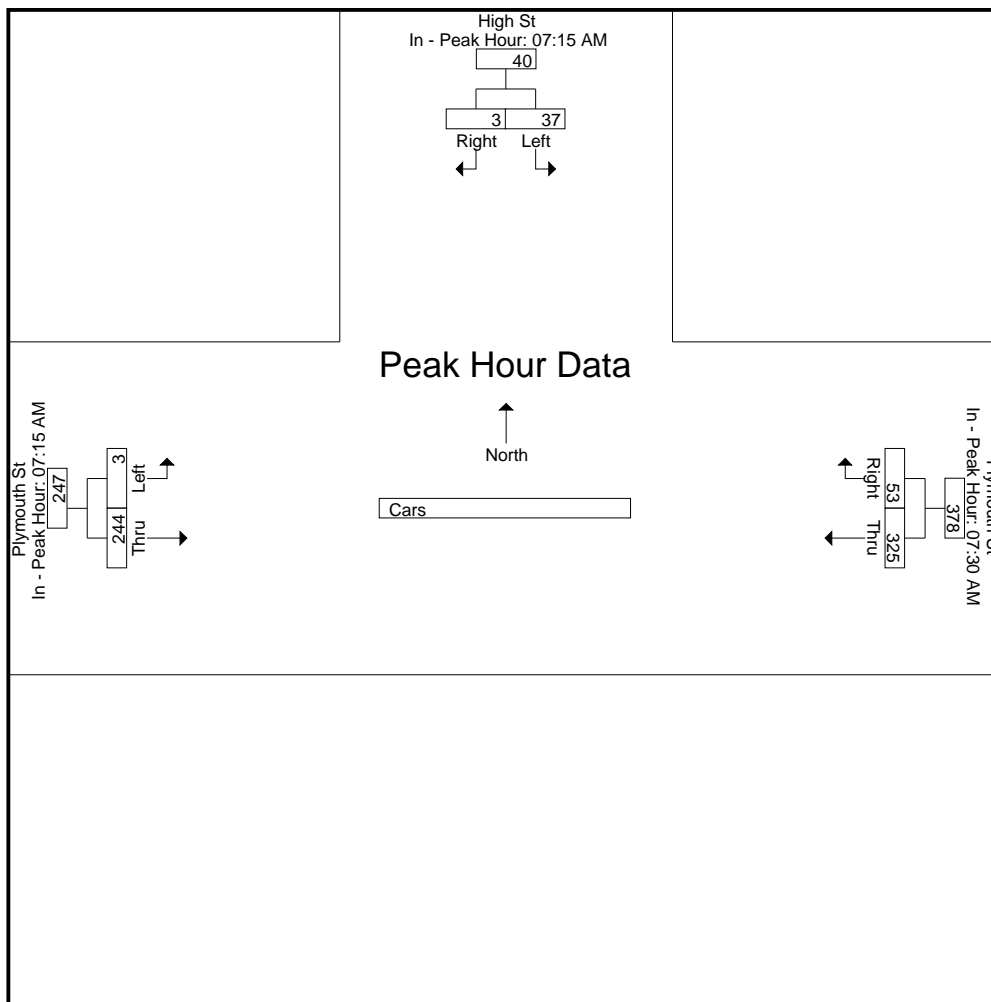

# Accurate Counts

978-664-2565

N/S Street : High Street  
 E/W Street : Plymouth Street  
 City/State : Bridgewater, MA  
 Weather : Clear

File Name : 20270B21  
 Site Code : 20270021  
 Start Date : 10/2/2024  
 Page No : 7

### Groups Printed- Trucks

Start Time	High St From North		Plymouth St From East		Plymouth St From West		Int. Total
	Left	Right	Thru	Right	Left	Thru	
07:00 AM	0	0	2	1	0	5	8
07:15 AM	0	0	4	0	0	5	9
07:30 AM	0	2	2	0	0	4	8
07:45 AM	0	0	7	0	1	5	13
<b>Total</b>	0	2	15	1	1	19	38
08:00 AM	0	0	8	0	0	3	11
08:15 AM	0	0	2	1	0	6	9
08:30 AM	0	0	2	1	0	6	9
08:45 AM	0	0	9	0	0	5	14
<b>Total</b>	0	0	21	2	0	20	43
<b>Grand Total</b>	0	2	36	3	1	39	81
Apprch %	0	100	92.3	7.7	2.5	97.5	
Total %	0	2.5	44.4	3.7	1.2	48.1	

Start Time	High St From North			Plymouth St From East			Plymouth St From West			Int. Total
	Left	Right	App. Total	Thru	Right	App. Total	Left	Thru	App. Total	
Peak Hour Analysis From 07:00 AM to 08:45 AM - Peak 1 of 1										
Peak Hour for Entire Intersection Begins at 08:00 AM										
08:00 AM	0	0	0	8	0	8	0	3	3	11
08:15 AM	0	0	0	2	1	3	0	6	6	9
08:30 AM	0	0	0	2	1	3	0	6	6	9
08:45 AM	0	0	0	9	0	9	0	5	5	14
<b>Total Volume</b>	0	0	0	21	2	23	0	20	20	43
<b>% App. Total</b>	0	0		91.3	8.7		0	100		
PHF	.000	.000	.000	.583	.500	.639	.000	.833	.833	.768

# Accurate Counts

978-664-2565

File Name : 20270B21

Site Code : 20270021

Start Date : 10/2/2024

Page No : 8

N/S Street : High Street  
 E/W Street : Plymouth Street  
 City/State : Bridgewater, MA  
 Weather : Clear

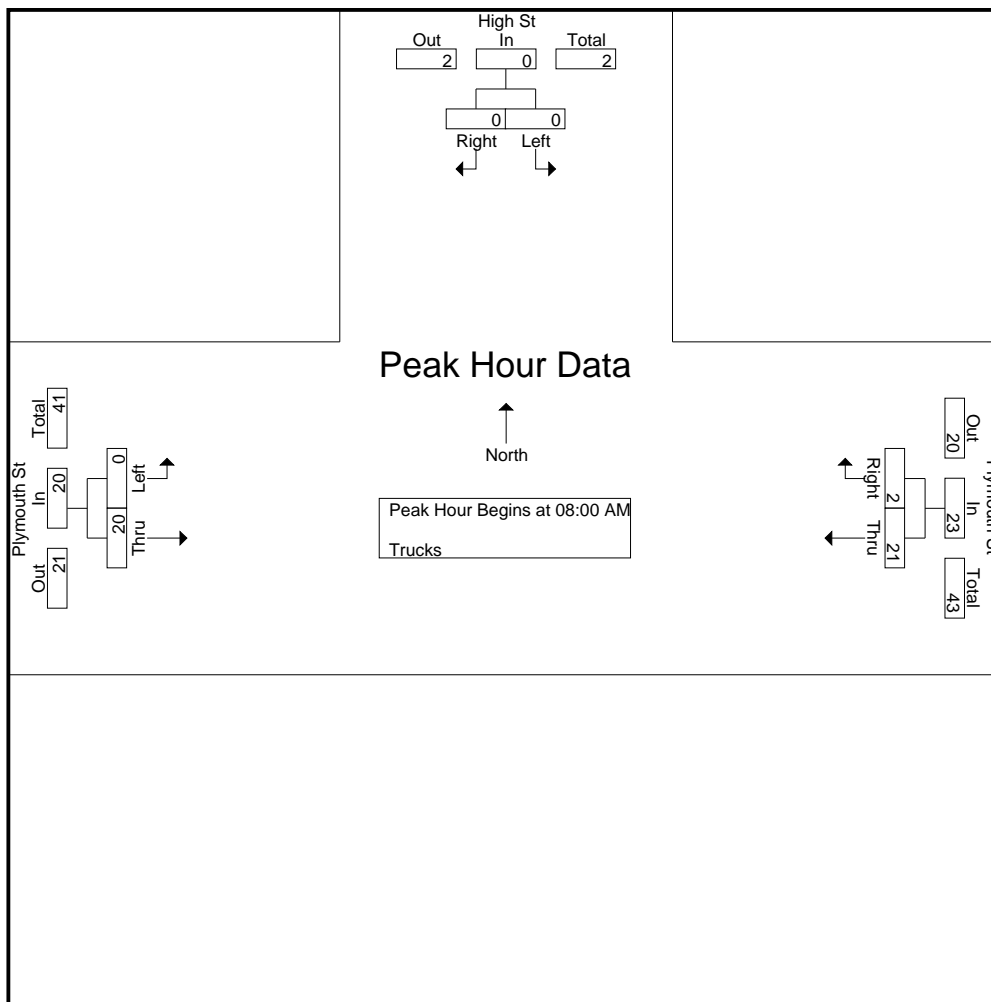

Peak Hour Analysis From 07:00 AM to 08:45 AM - Peak 1 of 1

Peak Hour for Each Approach Begins at:

	07:00 AM			08:00 AM			07:45 AM		
+0 mins.	0	0	0	8	0	8	1	5	6
+15 mins.	0	0	0	2	1	3	0	3	3
+30 mins.	0	2	2	2	1	3	0	6	6
+45 mins.	0	0	0	9	0	9	0	6	6
Total Volume	0	2	2	21	2	23	1	20	21
% App. Total	0	100		91.3	8.7		4.8	95.2	
PHF	.000	.250	.250	.583	.500	.639	.250	.833	.875



# Accurate Counts

978-664-2565

File Name : 20270B21

Site Code : 20270021

Start Date : 10/2/2024

Page No : 9

N/S Street : High Street  
E/W Street : Plymouth Street  
City/State : Bridgewater, MA  
Weather : Clear

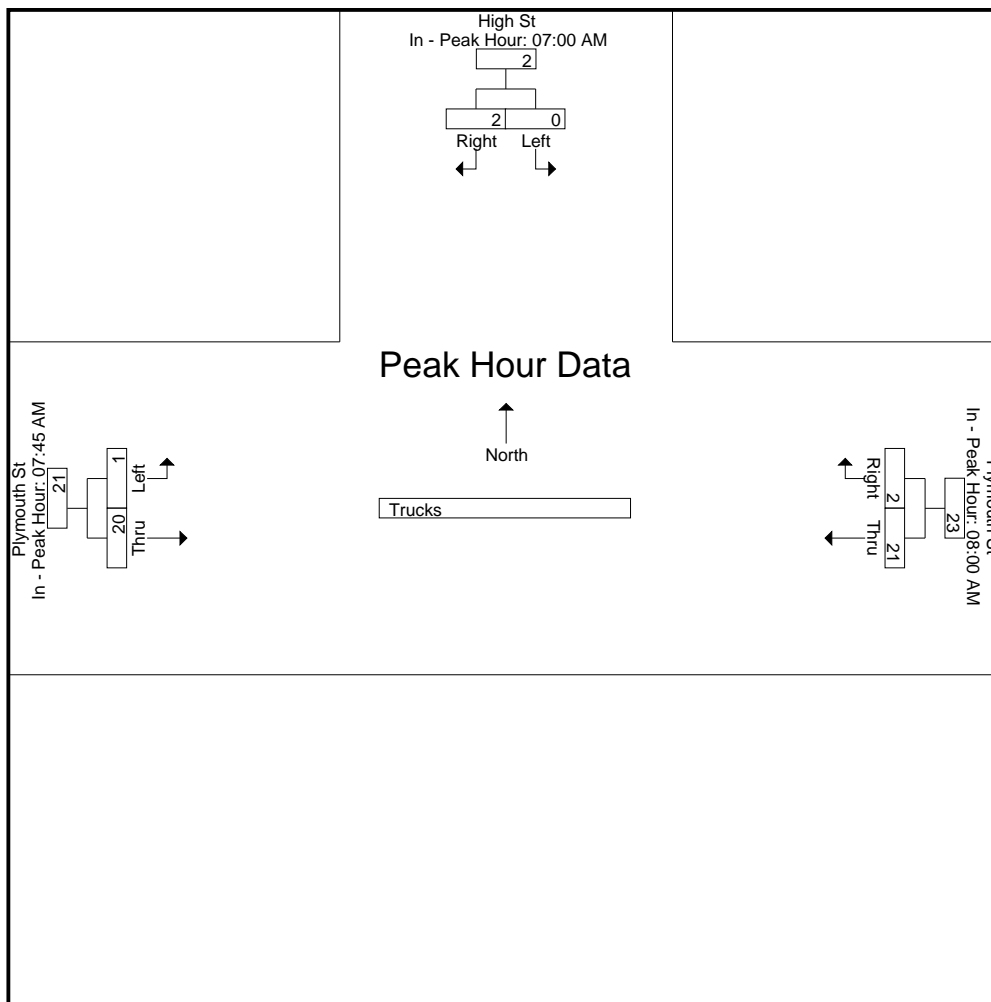

# Accurate Counts

978-664-2565

N/S Street : High Street  
 E/W Street : Plymouth Street  
 City/State : Bridgewater, MA  
 Weather : Clear

File Name : 20270B21  
 Site Code : 20270021  
 Start Date : 10/2/2024  
 Page No : 10

### Groups Printed- Bikes Peds

Start Time	High St From North			Plymouth St From East			Plymouth St From West			Exclu. Total	Inclu. Total	Int. Total
	Left	Right	Peds	Thru	Right	Peds	Left	Thru	Peds			
07:00 AM	0	0	0	0	0	0	0	0	0	0	0	0
07:15 AM	0	0	0	0	0	0	0	0	0	0	0	0
07:30 AM	0	0	0	1	0	0	0	0	0	0	1	1
07:45 AM	0	0	0	1	0	0	0	0	0	0	1	1
<b>Total</b>	0	0	0	2	0	0	0	0	0	0	2	2
08:00 AM	0	0	0	0	0	0	0	0	0	0	0	0
08:15 AM	0	0	0	0	0	0	0	0	0	0	0	0
08:30 AM	0	0	0	0	0	0	0	0	0	0	0	0
08:45 AM	0	0	0	0	0	0	0	1	0	0	1	1
<b>Total</b>	0	0	0	0	0	0	0	1	0	0	1	1
<b>Grand Total</b>	0	0	0	2	0	0	0	1	0	0	3	3
Apprch %	0	0		100	0		0	100				
Total %	0	0		66.7	0		0	33.3		0	100	

Start Time	High St From North			Plymouth St From East			Plymouth St From West			Int. Total
	Left	Right	App. Total	Thru	Right	App. Total	Left	Thru	App. Total	
Peak Hour Analysis From 07:00 AM to 08:45 AM - Peak 1 of 1										
Peak Hour for Entire Intersection Begins at 07:00 AM										
07:00 AM	0	0	0	0	0	0	0	0	0	0
07:15 AM	0	0	0	0	0	0	0	0	0	0
07:30 AM	0	0	0	1	0	1	0	0	0	1
07:45 AM	0	0	0	1	0	1	0	0	0	1
<b>Total Volume</b>	0	0	0	2	0	2	0	0	0	2
<b>% App. Total</b>	0	0		100	0		0	0		
PHF	.000	.000	.000	.500	.000	.500	.000	.000	.000	.500

# Accurate Counts

978-664-2565

N/S Street : High Street  
 E/W Street : Plymouth Street  
 City/State : Bridgewater, MA  
 Weather : Clear

File Name : 20270B21  
 Site Code : 20270021  
 Start Date : 10/2/2024  
 Page No : 11

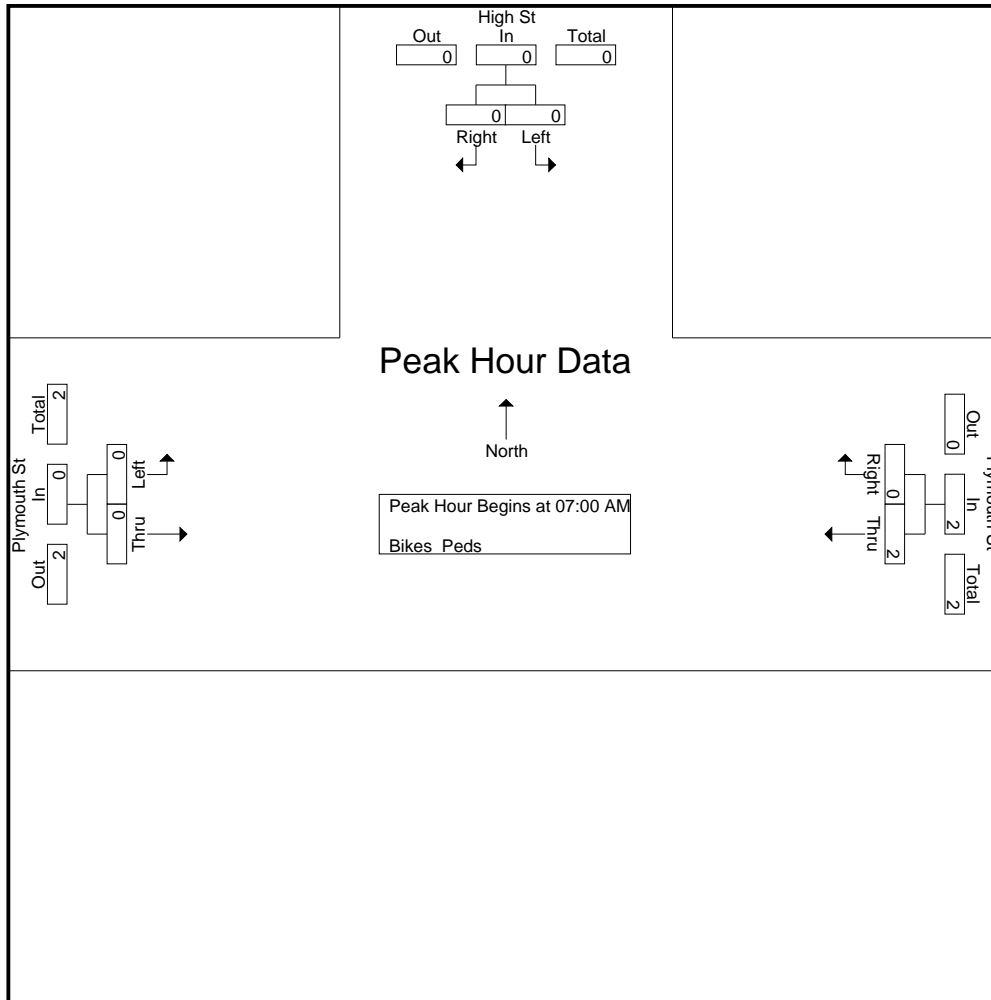

**Peak Hour Analysis From 07:00 AM to 08:45 AM - Peak 1 of 1**

Peak Hour for Each Approach Begins at:

	07:00 AM			07:00 AM			08:00 AM		
+0 mins.	0	0	0	0	0	0	0	0	0
+15 mins.	0	0	0	0	0	0	0	0	0
+30 mins.	0	0	0	1	0	1	0	0	0
+45 mins.	0	0	0	1	0	1	0	1	1
Total Volume	0	0	0	2	0	2	0	1	1
% App. Total	0	0	0	100	0	100	0	100	100
PHF	.000	.000	.000	.500	.000	.500	.000	.250	.250

# Accurate Counts

978-664-2565

File Name : 20270B21

Site Code : 20270021

Start Date : 10/2/2024

Page No : 12

N/S Street : High Street  
E/W Street : Plymouth Street  
City/State : Bridgewater, MA  
Weather : Clear

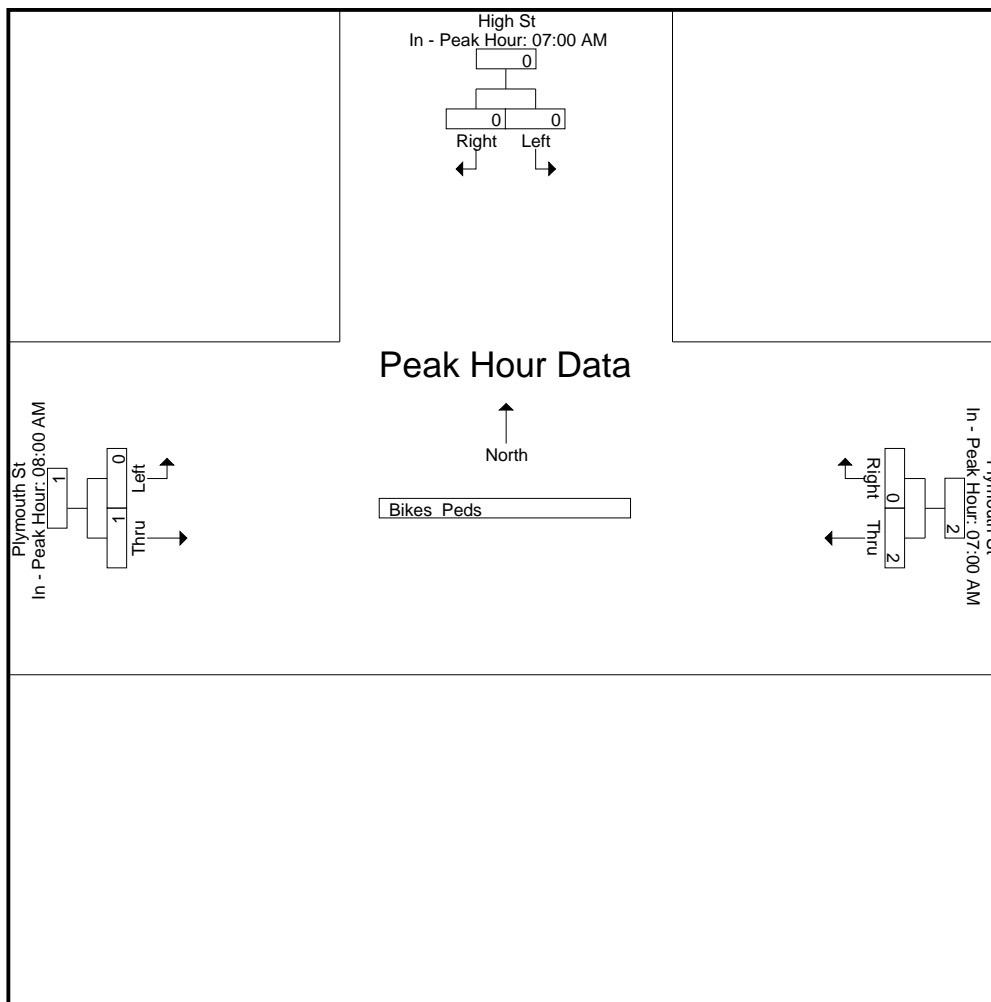

# Accurate Counts

978-664-2565

N/S Street : High Street  
 E/W Street : Plymouth Street  
 City/State : Bridgewater, MA  
 Weather : Clear

File Name : 20270B21  
 Site Code : 20270021  
 Start Date : 10/2/2024  
 Page No : 1

### Groups Printed- Cars - Trucks

Start Time	High St From North		Plymouth St From East		Plymouth St From West		Int. Total
	Left	Right	Thru	Right	Left	Thru	
04:00 PM	11	2	75	12	0	85	185
04:15 PM	18	0	90	18	1	73	200
04:30 PM	16	0	72	15	0	83	186
04:45 PM	13	0	84	11	0	106	214
<b>Total</b>	<b>58</b>	<b>2</b>	<b>321</b>	<b>56</b>	<b>1</b>	<b>347</b>	<b>785</b>
05:00 PM	14	1	94	14	0	74	197
05:15 PM	11	1	89	13	0	114	228
05:30 PM	16	0	98	11	1	73	199
05:45 PM	10	0	74	10	2	76	172
<b>Total</b>	<b>51</b>	<b>2</b>	<b>355</b>	<b>48</b>	<b>3</b>	<b>337</b>	<b>796</b>
<b>Grand Total</b>	<b>109</b>	<b>4</b>	<b>676</b>	<b>104</b>	<b>4</b>	<b>684</b>	<b>1581</b>
Apprch %	96.5	3.5	86.7	13.3	0.6	99.4	
Total %	6.9	0.3	42.8	6.6	0.3	43.3	
Cars	109	4	668	103	4	672	1560
% Cars	100	100	98.8	99	100	98.2	98.7
Trucks	0	0	8	1	0	12	21
% Trucks	0	0	1.2	1	0	1.8	1.3

Start Time	High St From North			Plymouth St From East			Plymouth St From West			Int. Total
	Left	Right	App. Total	Thru	Right	App. Total	Left	Thru	App. Total	
Peak Hour Analysis From 04:00 PM to 05:45 PM - Peak 1 of 1										
Peak Hour for Entire Intersection Begins at 04:45 PM										
04:45 PM	13	0	13	84	11	95	0	106	106	214
05:00 PM	14	1	15	94	14	108	0	74	74	197
05:15 PM	11	1	12	89	13	102	0	114	114	228
05:30 PM	16	0	16	98	11	109	1	73	74	199
Total Volume	54	2	56	365	49	414	1	367	368	838
% App. Total	96.4	3.6		88.2	11.8		0.3	99.7		
PHF	.844	.500	.875	.931	.875	.950	.250	.805	.807	.919
Cars	54	2	56	362	48	410	1	362	363	829
% Cars	100	100	100	99.2	98.0	99.0	100	98.6	98.6	98.9
Trucks	0	0	0	3	1	4	0	5	5	9
% Trucks	0	0	0	0.8	2.0	1.0	0	1.4	1.4	1.1

# Accurate Counts

978-664-2565

File Name : 20270B21

Site Code : 20270021

Start Date : 10/2/2024

Page No : 2

N/S Street : High Street  
 E/W Street : Plymouth Street  
 City/State : Bridgewater, MA  
 Weather : Clear

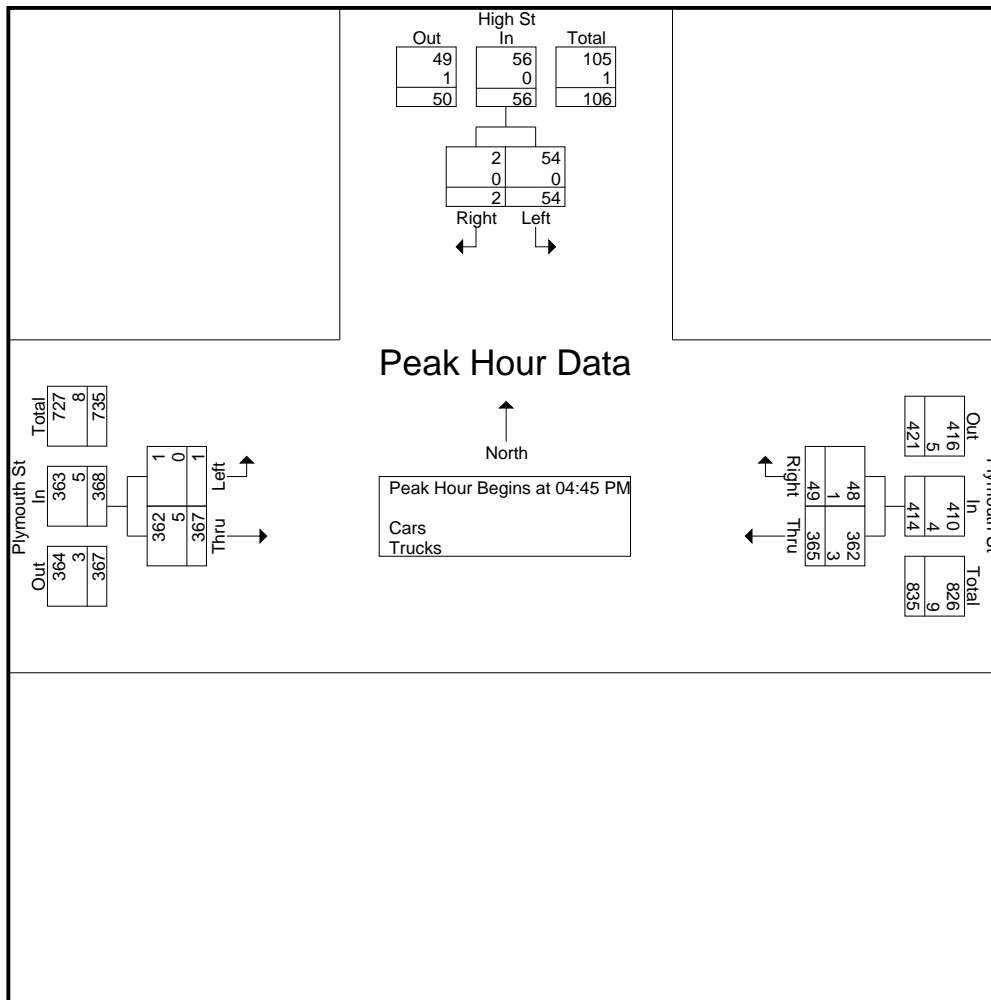

**Peak Hour Analysis From 04:00 PM to 05:45 PM - Peak 1 of 1**

Peak Hour for Each Approach Begins at:

	04:15 PM			04:45 PM			04:30 PM		
+0 mins.	<b>18</b>	0	<b>18</b>	84	11	95	0	83	83
+15 mins.	16	0	16	94	<b>14</b>	108	0	106	106
+30 mins.	13	0	13	89	13	102	0	74	74
+45 mins.	14	<b>1</b>	15	<b>98</b>	11	<b>109</b>	0	<b>114</b>	<b>114</b>
Total Volume	61	1	62	365	49	414	0	377	377
% App. Total	98.4	1.6		88.2	11.8		0	100	
PHF	.847	.250	.861	.931	.875	.950	.000	.827	.827
Cars	61	1	62	362	48	410	0	372	372
% Cars	100	100	100	99.2	98	99	0	98.7	98.7
Trucks	0	0	0	3	1	4	0	5	5
% Trucks	0	0	0	0.8	2	1	0	1.3	1.3

# Accurate Counts

978-664-2565

File Name : 20270B21

Site Code : 20270021

Start Date : 10/2/2024

Page No : 3

N/S Street : High Street  
 E/W Street : Plymouth Street  
 City/State : Bridgewater, MA  
 Weather : Clear

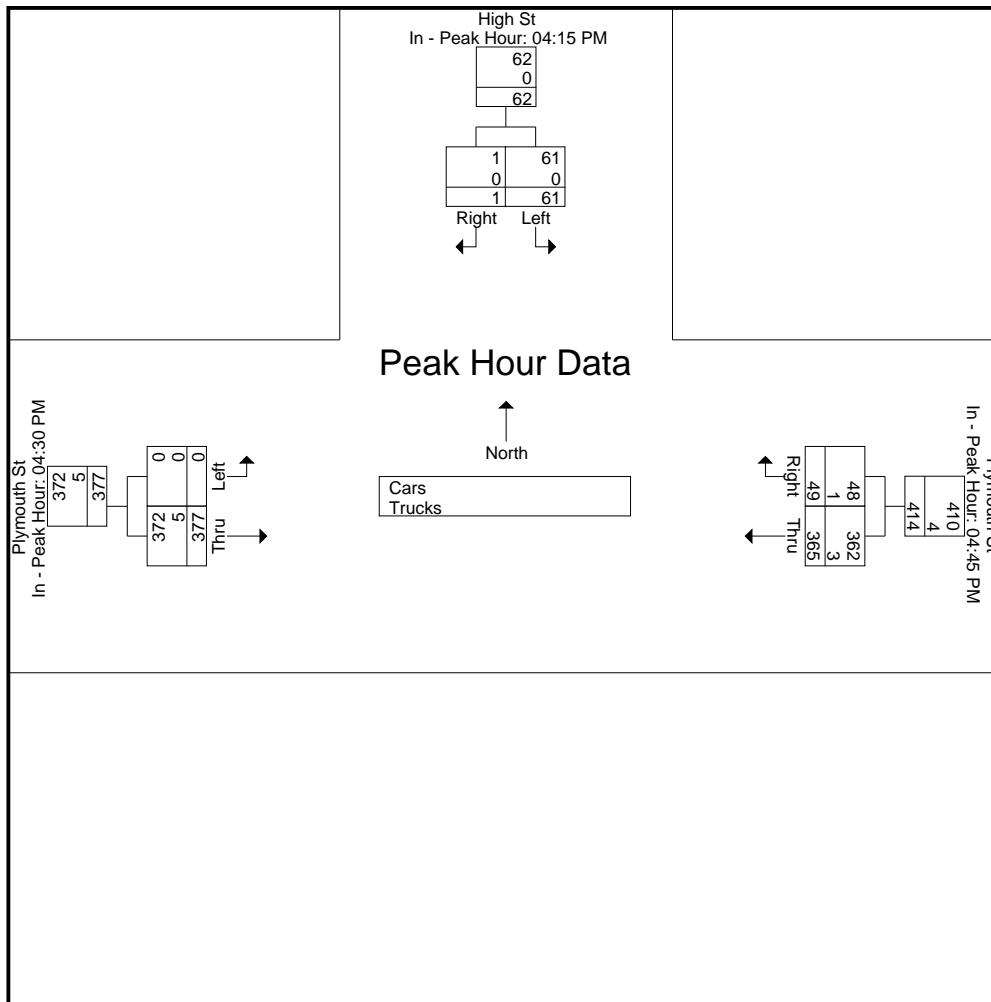

# Accurate Counts

978-664-2565

N/S Street : High Street  
 E/W Street : Plymouth Street  
 City/State : Bridgewater, MA  
 Weather : Clear

File Name : 20270B21  
 Site Code : 20270021  
 Start Date : 10/2/2024  
 Page No : 4

### Groups Printed- Cars

Start Time	High St From North		Plymouth St From East		Plymouth St From West		Int. Total
	Left	Right	Thru	Right	Left	Thru	
04:00 PM	11	2	73	12	0	81	179
04:15 PM	18	0	87	18	1	72	196
04:30 PM	16	0	72	15	0	82	185
04:45 PM	13	0	82	11	0	103	209
<b>Total</b>	<b>58</b>	<b>2</b>	<b>314</b>	<b>56</b>	<b>1</b>	<b>338</b>	<b>769</b>
05:00 PM	14	1	93	14	0	73	195
05:15 PM	11	1	89	12	0	114	227
05:30 PM	16	0	98	11	1	72	198
05:45 PM	10	0	74	10	2	75	171
<b>Total</b>	<b>51</b>	<b>2</b>	<b>354</b>	<b>47</b>	<b>3</b>	<b>334</b>	<b>791</b>
<b>Grand Total</b>	<b>109</b>	<b>4</b>	<b>668</b>	<b>103</b>	<b>4</b>	<b>672</b>	<b>1560</b>
Apprch %	96.5	3.5	86.6	13.4	0.6	99.4	
Total %	7	0.3	42.8	6.6	0.3	43.1	

Start Time	High St From North			Plymouth St From East			Plymouth St From West			Int. Total
	Left	Right	App. Total	Thru	Right	App. Total	Left	Thru	App. Total	
Peak Hour Analysis From 04:00 PM to 05:45 PM - Peak 1 of 1										
Peak Hour for Entire Intersection Begins at 04:45 PM										
04:45 PM	13	0	13	82	11	93	0	103	103	209
05:00 PM	14	1	15	93	14	107	0	73	73	195
05:15 PM	11	1	12	89	12	101	0	114	114	227
05:30 PM	16	0	16	98	11	109	1	72	73	198
<b>Total Volume</b>	<b>54</b>	<b>2</b>	<b>56</b>	<b>362</b>	<b>48</b>	<b>410</b>	<b>1</b>	<b>362</b>	<b>363</b>	<b>829</b>
<b>% App. Total</b>	<b>96.4</b>	<b>3.6</b>		<b>88.3</b>	<b>11.7</b>		<b>0.3</b>	<b>99.7</b>		
PHF	.844	.500	.875	.923	.857	.940	.250	.794	.796	.913



# Accurate Counts

978-664-2565

N/S Street : High Street  
 E/W Street : Plymouth Street  
 City/State : Bridgewater, MA  
 Weather : Clear

File Name : 20270B21  
 Site Code : 20270021  
 Start Date : 10/2/2024  
 Page No : 5

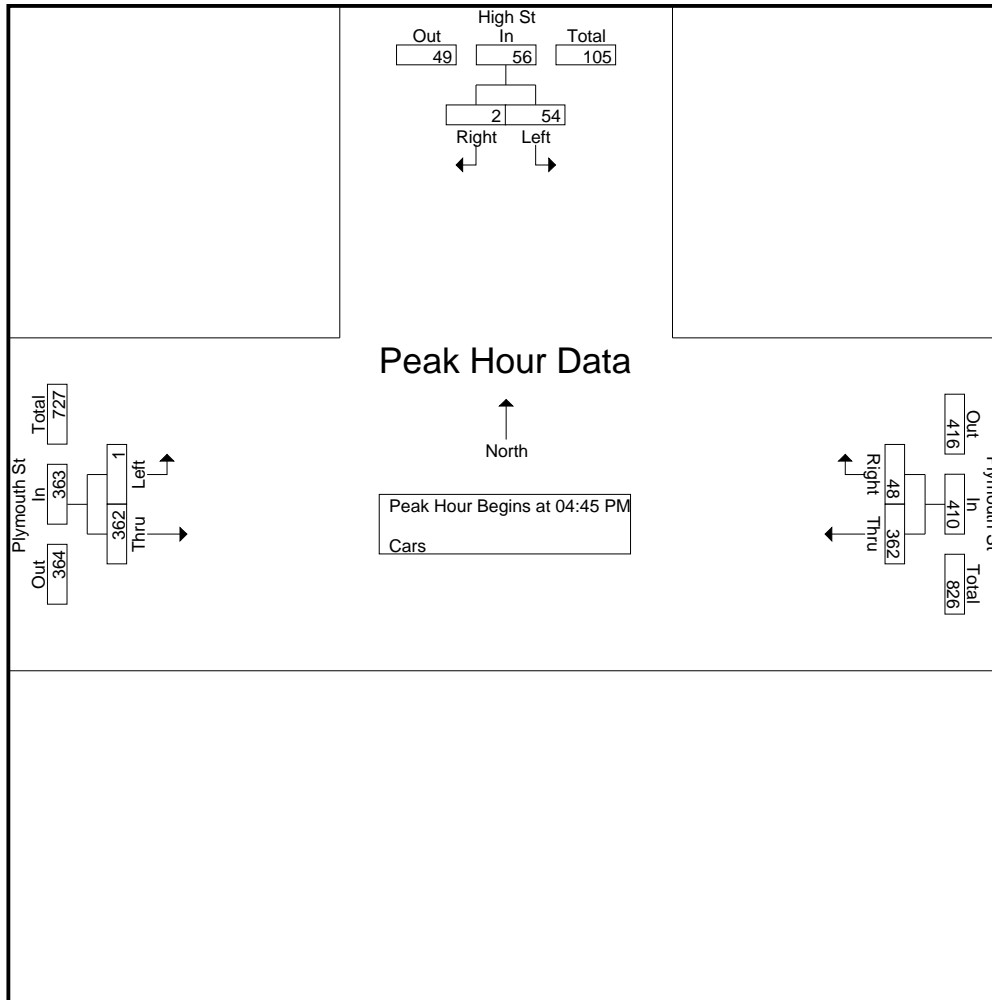

**Peak Hour Analysis From 04:00 PM to 05:45 PM - Peak 1 of 1**

Peak Hour for Each Approach Begins at:

	04:15 PM			04:45 PM			04:30 PM		
+0 mins.	<b>18</b>	0	<b>18</b>	82	11	93	0	82	82
+15 mins.	16	0	16	93	<b>14</b>	107	0	103	103
+30 mins.	13	0	13	89	12	101	0	73	73
+45 mins.	14	<b>1</b>	15	<b>98</b>	11	<b>109</b>	0	<b>114</b>	<b>114</b>
Total Volume	61	1	62	362	48	410	0	372	372
% App. Total	98.4	1.6		88.3	11.7		0	100	
PHF	.847	.250	.861	.923	.857	.940	.000	.816	.816

# Accurate Counts

978-664-2565

File Name : 20270B21

Site Code : 20270021

Start Date : 10/2/2024

Page No : 6

N/S Street : High Street  
E/W Street : Plymouth Street  
City/State : Bridgewater, MA  
Weather : Clear

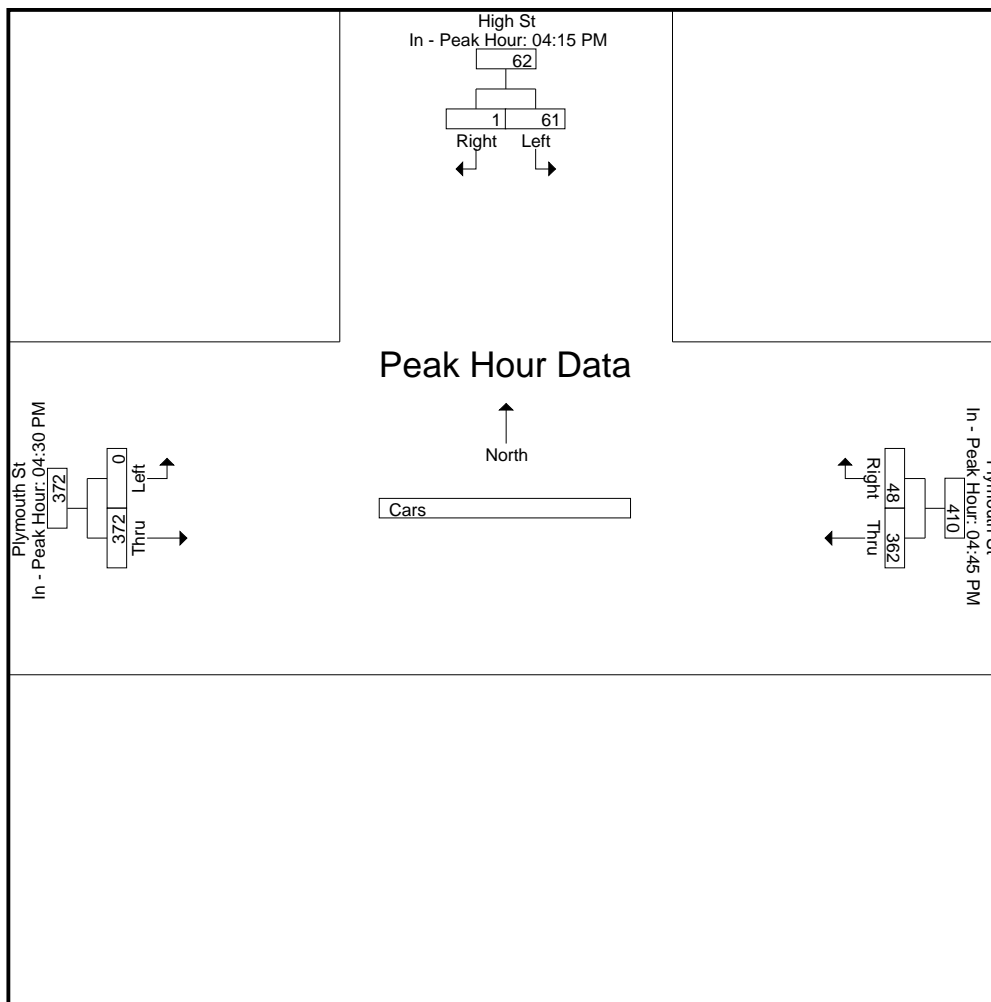

# Accurate Counts

978-664-2565

N/S Street : High Street  
 E/W Street : Plymouth Street  
 City/State : Bridgewater, MA  
 Weather : Clear

File Name : 20270B21  
 Site Code : 20270021  
 Start Date : 10/2/2024  
 Page No : 7

### Groups Printed- Trucks

Start Time	High St From North		Plymouth St From East		Plymouth St From West		Int. Total
	Left	Right	Thru	Right	Left	Thru	
04:00 PM	0	0	2	0	0	4	6
04:15 PM	0	0	3	0	0	1	4
04:30 PM	0	0	0	0	0	1	1
04:45 PM	0	0	2	0	0	3	5
<b>Total</b>	<b>0</b>	<b>0</b>	<b>7</b>	<b>0</b>	<b>0</b>	<b>9</b>	<b>16</b>
05:00 PM	0	0	1	0	0	1	2
05:15 PM	0	0	0	1	0	0	1
05:30 PM	0	0	0	0	0	1	1
05:45 PM	0	0	0	0	0	1	1
<b>Total</b>	<b>0</b>	<b>0</b>	<b>1</b>	<b>1</b>	<b>0</b>	<b>3</b>	<b>5</b>
<b>Grand Total</b>	<b>0</b>	<b>0</b>	<b>8</b>	<b>1</b>	<b>0</b>	<b>12</b>	<b>21</b>
Apprch %	0	0	88.9	11.1	0	100	
Total %	0	0	38.1	4.8	0	57.1	

Start Time	High St From North			Plymouth St From East			Plymouth St From West			Int. Total
	Left	Right	App. Total	Thru	Right	App. Total	Left	Thru	App. Total	
Peak Hour Analysis From 04:00 PM to 05:45 PM - Peak 1 of 1										
Peak Hour for Entire Intersection Begins at 04:00 PM										
04:00 PM	0	0	0	2	0	2	0	4	4	6
04:15 PM	0	0	0	3	0	3	0	1	1	4
04:30 PM	0	0	0	0	0	0	0	1	1	1
04:45 PM	0	0	0	2	0	2	0	3	3	5
<b>Total Volume</b>	<b>0</b>	<b>0</b>	<b>0</b>	<b>7</b>	<b>0</b>	<b>7</b>	<b>0</b>	<b>9</b>	<b>9</b>	<b>16</b>
<b>% App. Total</b>	<b>0</b>	<b>0</b>	<b>0</b>	<b>100</b>	<b>0</b>	<b>100</b>	<b>0</b>	<b>100</b>	<b>100</b>	<b>100</b>
PHF	.000	.000	.000	.583	.000	.583	.000	.563	.563	.667

# Accurate Counts

978-664-2565

File Name : 20270B21

Site Code : 20270021

Start Date : 10/2/2024

Page No : 8

N/S Street : High Street  
 E/W Street : Plymouth Street  
 City/State : Bridgewater, MA  
 Weather : Clear

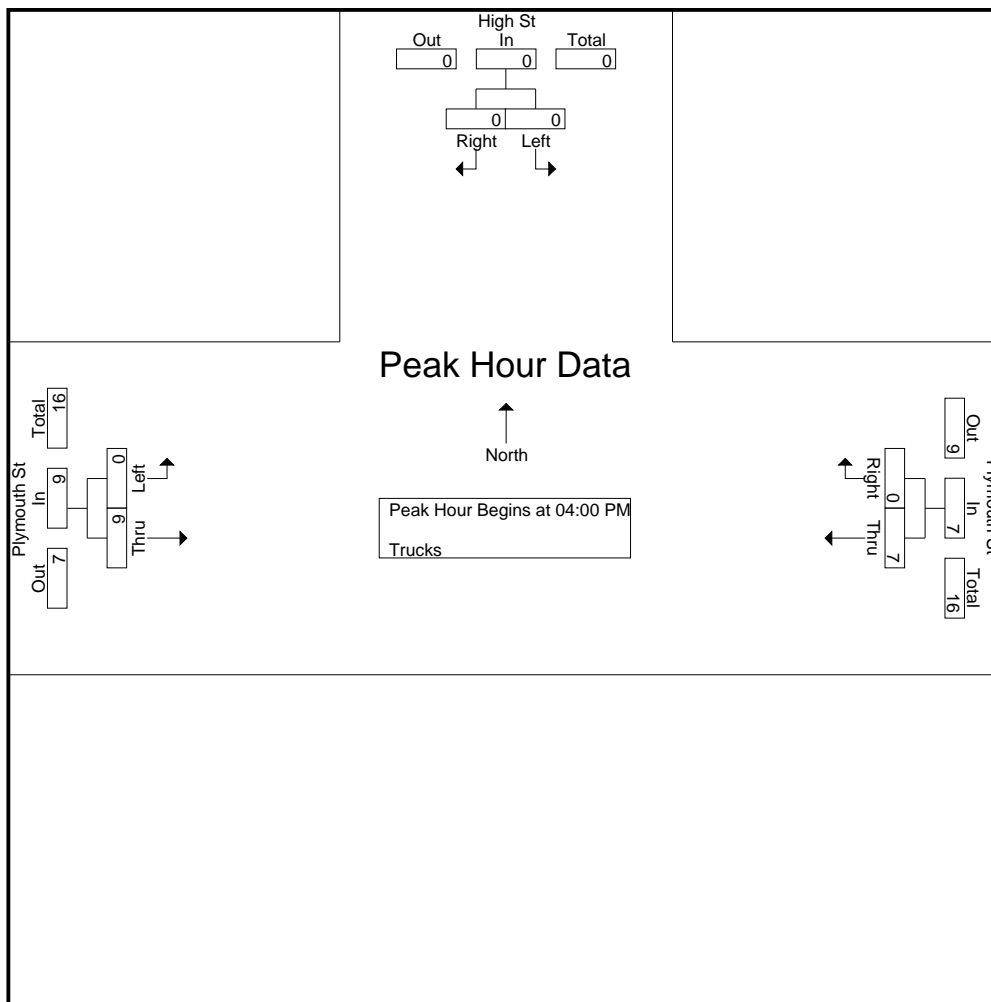

Peak Hour Analysis From 04:00 PM to 05:45 PM - Peak 1 of 1

Peak Hour for Each Approach Begins at:

	04:00 PM			04:00 PM			04:00 PM		
+0 mins.	0	0	0	2	0	2	0	4	4
+15 mins.	0	0	0	3	0	3	0	1	1
+30 mins.	0	0	0	0	0	0	0	1	1
+45 mins.	0	0	0	2	0	2	0	3	3
Total Volume	0	0	0	7	0	7	0	9	9
% App. Total	0	0	0	100	0	100	0	100	100
PHF	.000	.000	.000	.583	.000	.583	.000	.563	.563

# Accurate Counts

978-664-2565

File Name : 20270B21

Site Code : 20270021

Start Date : 10/2/2024

Page No : 9

N/S Street : High Street  
E/W Street : Plymouth Street  
City/State : Bridgewater, MA  
Weather : Clear

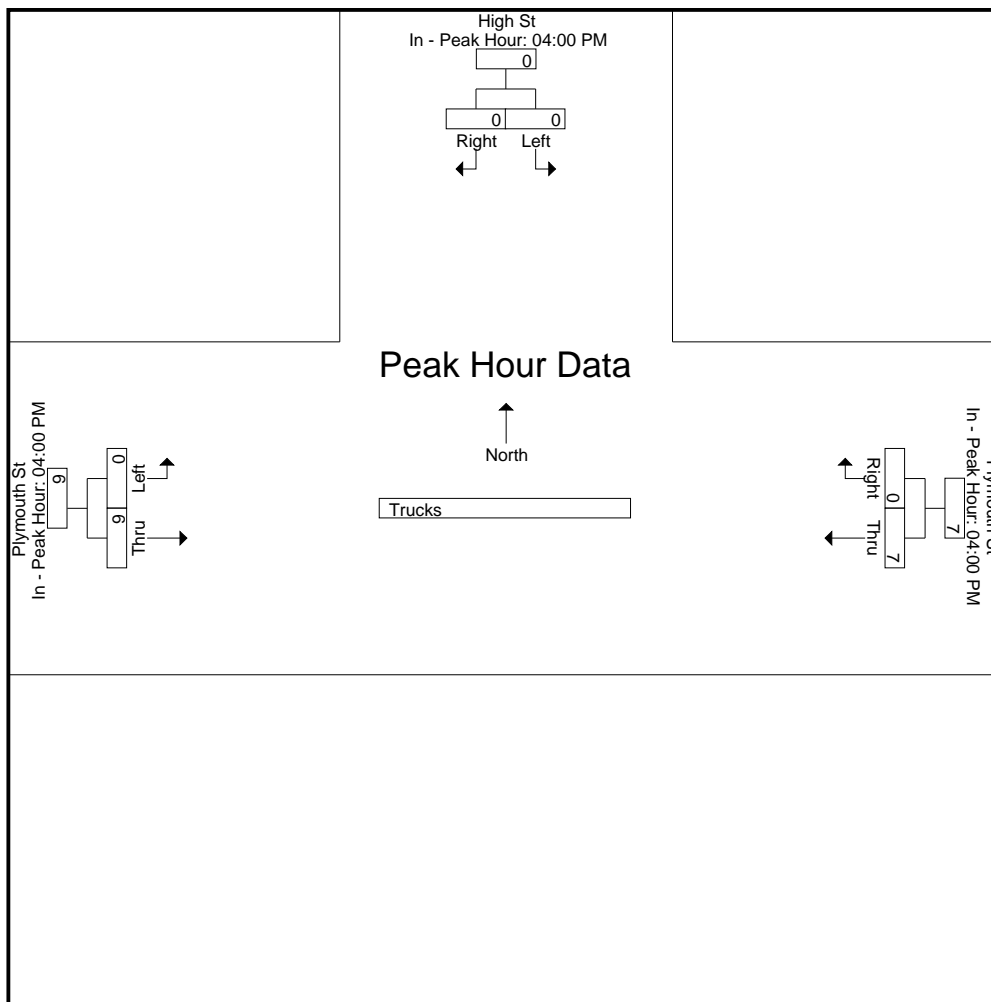



# Accurate Counts

978-664-2565

N/S Street : High Street  
 E/W Street : Plymouth Street  
 City/State : Bridgewater, MA  
 Weather : Clear

File Name : 20270B21  
 Site Code : 20270021  
 Start Date : 10/2/2024  
 Page No : 11

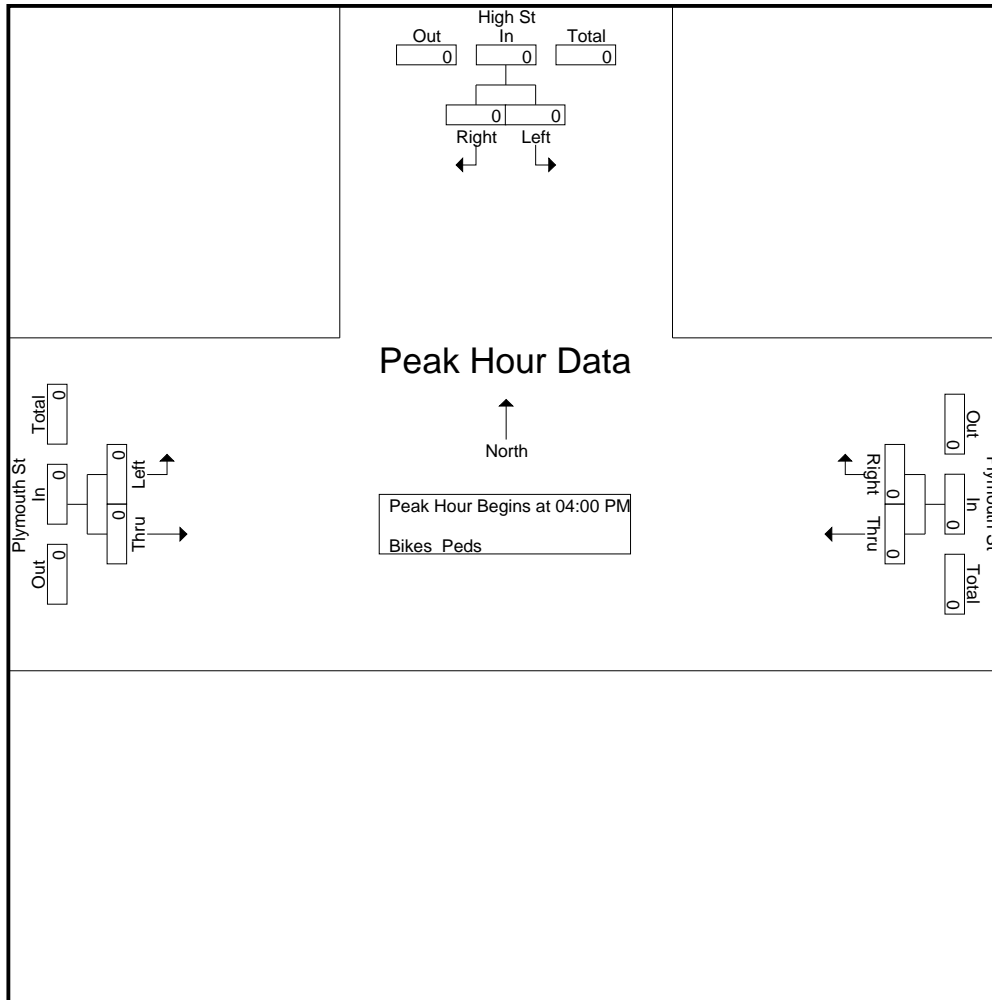

Peak Hour Analysis From 04:00 PM to 05:45 PM - Peak 1 of 1

Peak Hour for Each Approach Begins at:

	04:00 PM			04:00 PM			04:00 PM		
+0 mins.	0	0	0	0	0	0	0	0	0
+15 mins.	0	0	0	0	0	0	0	0	0
+30 mins.	0	0	0	0	0	0	0	0	0
+45 mins.	0	0	0	0	0	0	0	0	0
Total Volume	0	0	0	0	0	0	0	0	0
% App. Total	0	0	0	0	0	0	0	0	0
PHF	.000	.000	.000	.000	.000	.000	.000	.000	.000

# Accurate Counts

978-664-2565

File Name : 20270B21

Site Code : 20270021

Start Date : 10/2/2024

Page No : 12

N/S Street : High Street  
E/W Street : Plymouth Street  
City/State : Bridgewater, MA  
Weather : Clear

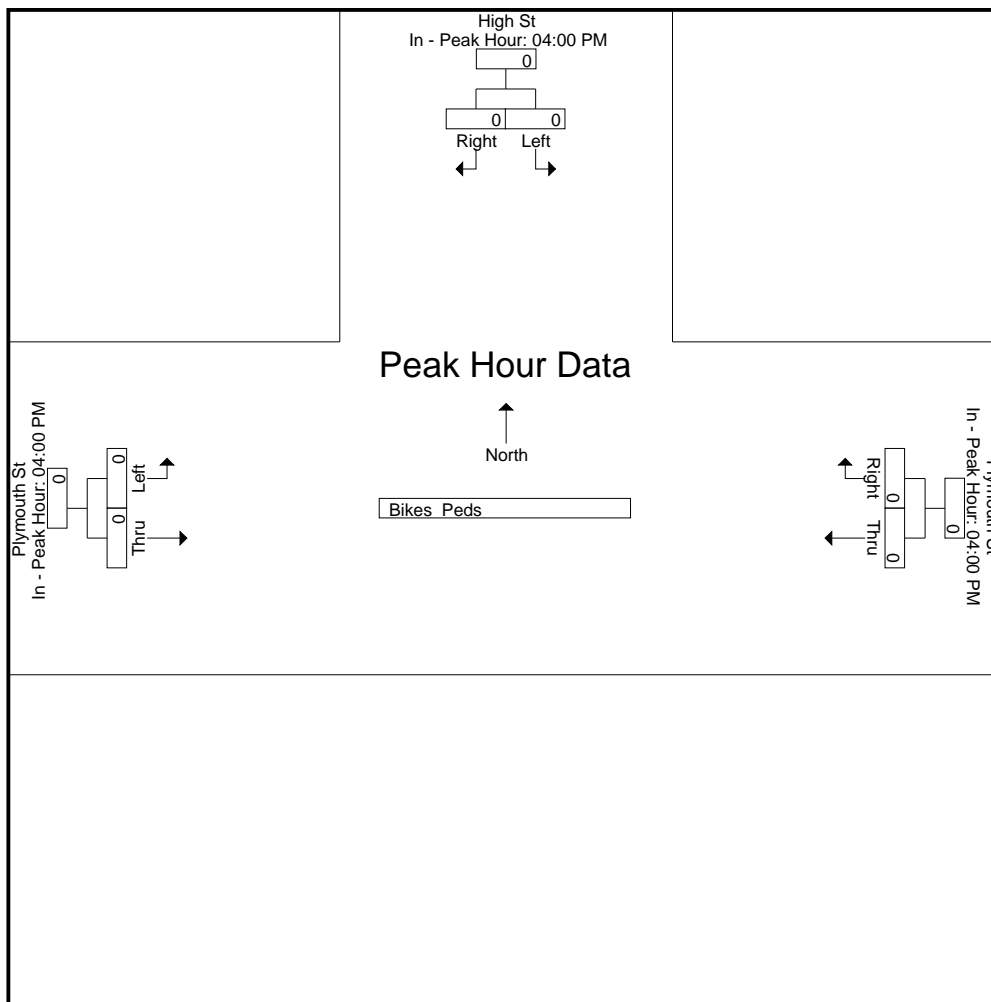



# Accurate Counts

978-664-2565

N/S Street : Roberts Road  
 E/W Street : Plymouth Street  
 City/State : Bridgewater, MA  
 Weather : Clear

File Name : 20270B22  
 Site Code : 20270022  
 Start Date : 10/2/2024  
 Page No : 1

### Groups Printed- Cars - Trucks

Start Time	Roberts Rd From North		Plymouth St From East		Plymouth St From West		Int. Total
	Left	Right	Thru	Right	Left	Thru	
07:00 AM	0	21	35	0	26	32	114
07:15 AM	0	23	50	0	30	45	148
07:30 AM	1	28	58	0	28	44	159
07:45 AM	0	20	60	2	33	39	154
<b>Total</b>	<b>1</b>	<b>92</b>	<b>203</b>	<b>2</b>	<b>117</b>	<b>160</b>	<b>575</b>
08:00 AM	1	19	43	0	25	47	135
08:15 AM	0	25	56	0	20	35	136
08:30 AM	0	18	60	1	21	30	130
08:45 AM	1	15	48	0	19	20	103
<b>Total</b>	<b>2</b>	<b>77</b>	<b>207</b>	<b>1</b>	<b>85</b>	<b>132</b>	<b>504</b>
<b>Grand Total</b>	<b>3</b>	<b>169</b>	<b>410</b>	<b>3</b>	<b>202</b>	<b>292</b>	<b>1079</b>
Apprch %	1.7	98.3	99.3	0.7	40.9	59.1	
Total %	0.3	15.7	38	0.3	18.7	27.1	
Cars	2	164	382	2	198	258	1006
% Cars	66.7	97	93.2	66.7	98	88.4	93.2
Trucks	1	5	28	1	4	34	73
% Trucks	33.3	3	6.8	33.3	2	11.6	6.8

Start Time	Roberts Rd From North			Plymouth St From East			Plymouth St From West			Int. Total
	Left	Right	App. Total	Thru	Right	App. Total	Left	Thru	App. Total	
Peak Hour Analysis From 07:00 AM to 08:45 AM - Peak 1 of 1										
Peak Hour for Entire Intersection Begins at 07:15 AM										
07:15 AM	0	23	23	50	0	50	30	45	<b>75</b>	148
07:30 AM	1	<b>28</b>	<b>29</b>	58	0	58	28	44	72	<b>159</b>
07:45 AM	0	20	20	<b>60</b>	<b>2</b>	<b>62</b>	<b>33</b>	39	72	154
08:00 AM	1	19	20	43	0	43	25	<b>47</b>	72	135
Total Volume	2	90	92	211	2	213	116	175	291	596
% App. Total	2.2	97.8		99.1	0.9		39.9	60.1		
PHF	.500	.804	.793	.879	.250	.859	.879	.931	.970	.937
Cars	2	88	90	196	1	197	113	160	273	560
% Cars	100	97.8	97.8	92.9	50.0	92.5	97.4	91.4	93.8	94.0
Trucks	0	2	2	15	1	16	3	15	18	36
% Trucks	0	2.2	2.2	7.1	50.0	7.5	2.6	8.6	6.2	6.0

# Accurate Counts

978-664-2565

N/S Street : Roberts Road  
 E/W Street : Plymouth Street  
 City/State : Bridgewater, MA  
 Weather : Clear

File Name : 20270B22  
 Site Code : 20270022  
 Start Date : 10/2/2024  
 Page No : 2

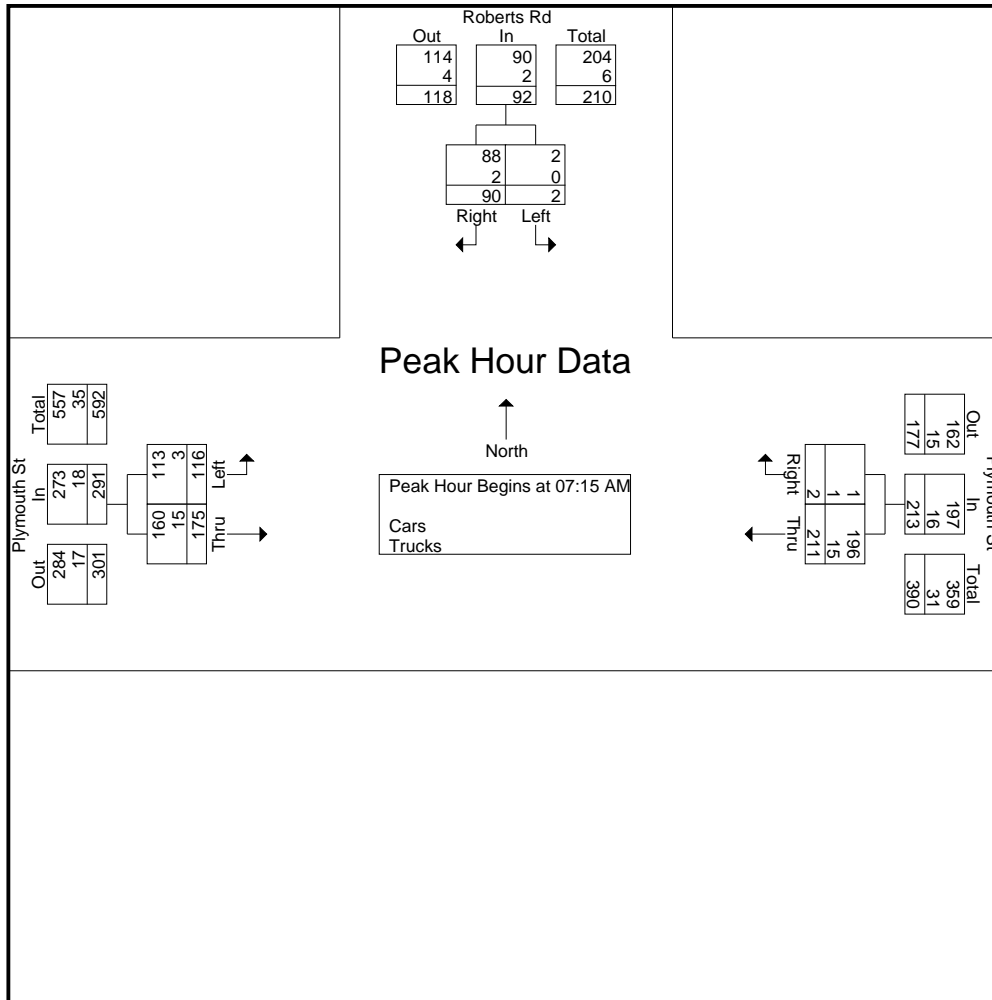

**Peak Hour Analysis From 07:00 AM to 08:45 AM - Peak 1 of 1**

Peak Hour for Each Approach Begins at:

	07:30 AM			07:45 AM			07:15 AM		
+0 mins.	1	28	29	60	2	62	30	45	75
+15 mins.	0	20	20	43	0	43	28	44	72
+30 mins.	1	19	20	56	0	56	33	39	72
+45 mins.	0	25	25	60	1	61	25	47	72
<b>Total Volume</b>	2	92	94	219	3	222	116	175	291
<b>% App. Total</b>	2.1	97.9		98.6	1.4		39.9	60.1	
<b>PHF</b>	.500	.821	.810	.913	.375	.895	.879	.931	.970
Cars	2	91	93	202	2	204	113	160	273
% Cars	100	98.9	98.9	92.2	66.7	91.9	97.4	91.4	93.8
Trucks	0	1	1	17	1	18	3	15	18
% Trucks	0	1.1	1.1	7.8	33.3	8.1	2.6	8.6	6.2

# Accurate Counts

978-664-2565

N/S Street : Roberts Road  
 E/W Street : Plymouth Street  
 City/State : Bridgewater, MA  
 Weather : Clear

File Name : 20270B22  
 Site Code : 20270022  
 Start Date : 10/2/2024  
 Page No : 3

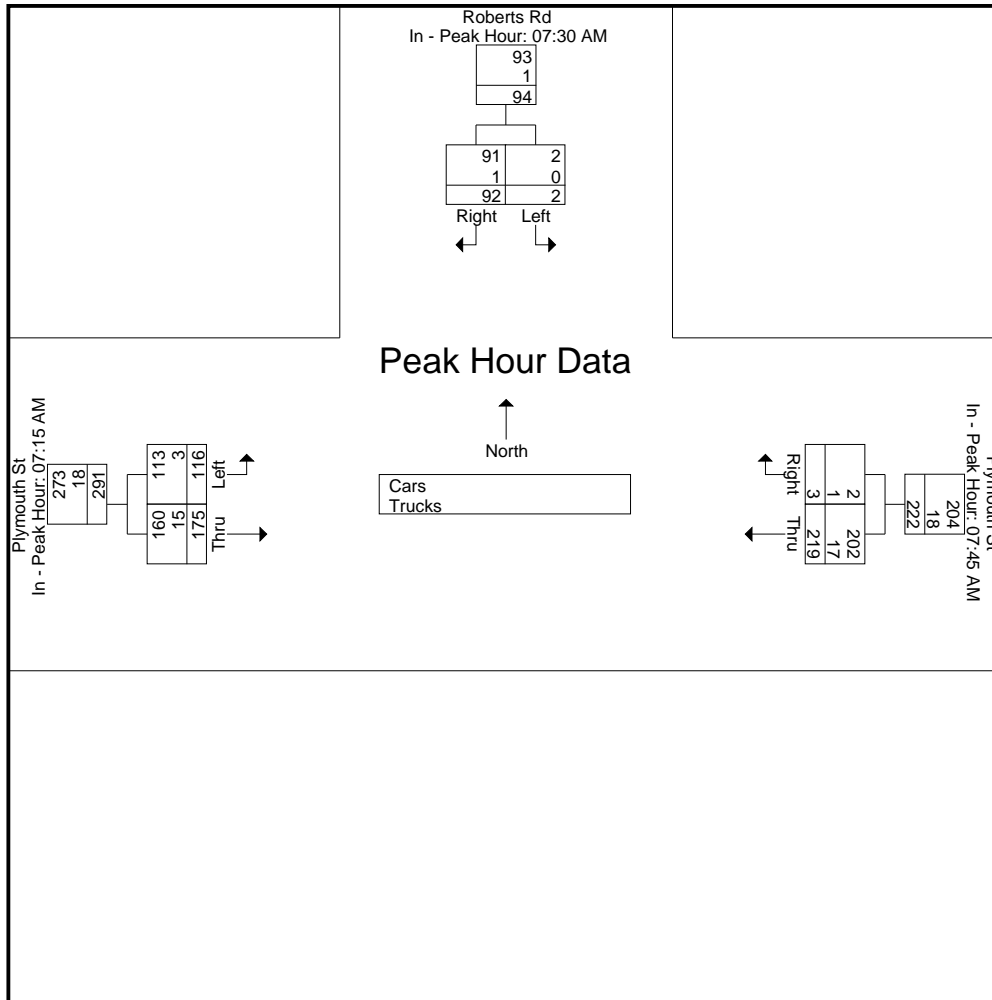

# Accurate Counts

978-664-2565

N/S Street : Roberts Road  
 E/W Street : Plymouth Street  
 City/State : Bridgewater, MA  
 Weather : Clear

File Name : 20270B22  
 Site Code : 20270022  
 Start Date : 10/2/2024  
 Page No : 4

### Groups Printed- Cars

Start Time	Roberts Rd From North		Plymouth St From East		Plymouth St From West		Int. Total
	Left	Right	Thru	Right	Left	Thru	
07:00 AM	0	20	33	0	25	28	106
07:15 AM	0	22	49	0	28	41	140
07:30 AM	1	28	56	0	28	41	154
07:45 AM	0	19	54	1	32	34	140
<b>Total</b>	<b>1</b>	<b>89</b>	<b>192</b>	<b>1</b>	<b>113</b>	<b>144</b>	<b>540</b>
08:00 AM	1	19	37	0	25	44	126
08:15 AM	0	25	54	0	20	29	128
08:30 AM	0	18	57	1	21	27	124
08:45 AM	0	13	42	0	19	14	88
<b>Total</b>	<b>1</b>	<b>75</b>	<b>190</b>	<b>1</b>	<b>85</b>	<b>114</b>	<b>466</b>
<b>Grand Total</b>	<b>2</b>	<b>164</b>	<b>382</b>	<b>2</b>	<b>198</b>	<b>258</b>	<b>1006</b>
Apprch %	1.2	98.8	99.5	0.5	43.4	56.6	
Total %	0.2	16.3	38	0.2	19.7	25.6	

Start Time	Roberts Rd From North			Plymouth St From East			Plymouth St From West			Int. Total
	Left	Right	App. Total	Thru	Right	App. Total	Left	Thru	App. Total	
Peak Hour Analysis From 07:00 AM to 08:45 AM - Peak 1 of 1										
Peak Hour for Entire Intersection Begins at 07:15 AM										
07:15 AM	0	22	22	49	0	49	28	41	<b>69</b>	140
07:30 AM	<b>1</b>	<b>28</b>	<b>29</b>	<b>56</b>	0	<b>56</b>	28	41	69	<b>154</b>
07:45 AM	0	19	19	54	<b>1</b>	55	<b>32</b>	34	66	140
08:00 AM	1	19	20	37	0	37	25	<b>44</b>	69	126
Total Volume	2	88	90	196	1	197	113	160	273	560
% App. Total	2.2	97.8		99.5	0.5		41.4	58.6		
PHF	.500	.786	.776	.875	.250	.879	.883	.909	.989	.909

# Accurate Counts

978-664-2565

N/S Street : Roberts Road  
 E/W Street : Plymouth Street  
 City/State : Bridgewater, MA  
 Weather : Clear

File Name : 20270B22  
 Site Code : 20270022  
 Start Date : 10/2/2024  
 Page No : 5

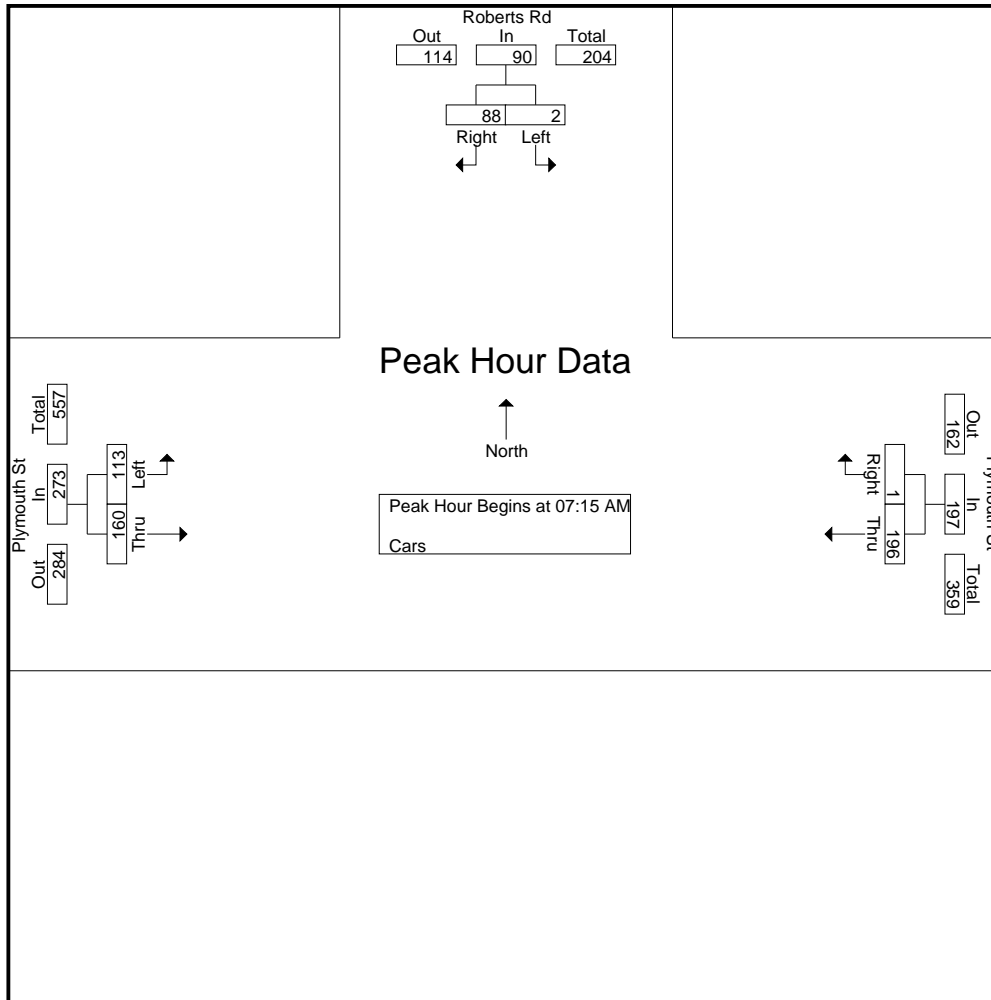

**Peak Hour Analysis From 07:00 AM to 08:45 AM - Peak 1 of 1**

Peak Hour for Each Approach Begins at:

	07:30 AM			07:45 AM			07:15 AM		
+0 mins.	1	28	29	54	1	55	28	41	69
+15 mins.	0	19	19	37	0	37	28	41	69
+30 mins.	1	19	20	54	0	54	32	34	66
+45 mins.	0	25	25	57	1	58	25	44	69
Total Volume	2	91	93	202	2	204	113	160	273
% App. Total	2.2	97.8		99	1		41.4	58.6	
PHF	.500	.813	.802	.886	.500	.879	.883	.909	.989

# Accurate Counts

978-664-2565

File Name : 20270B22

Site Code : 20270022

Start Date : 10/2/2024

Page No : 6

N/S Street : Roberts Road  
E/W Street : Plymouth Street  
City/State : Bridgewater, MA  
Weather : Clear

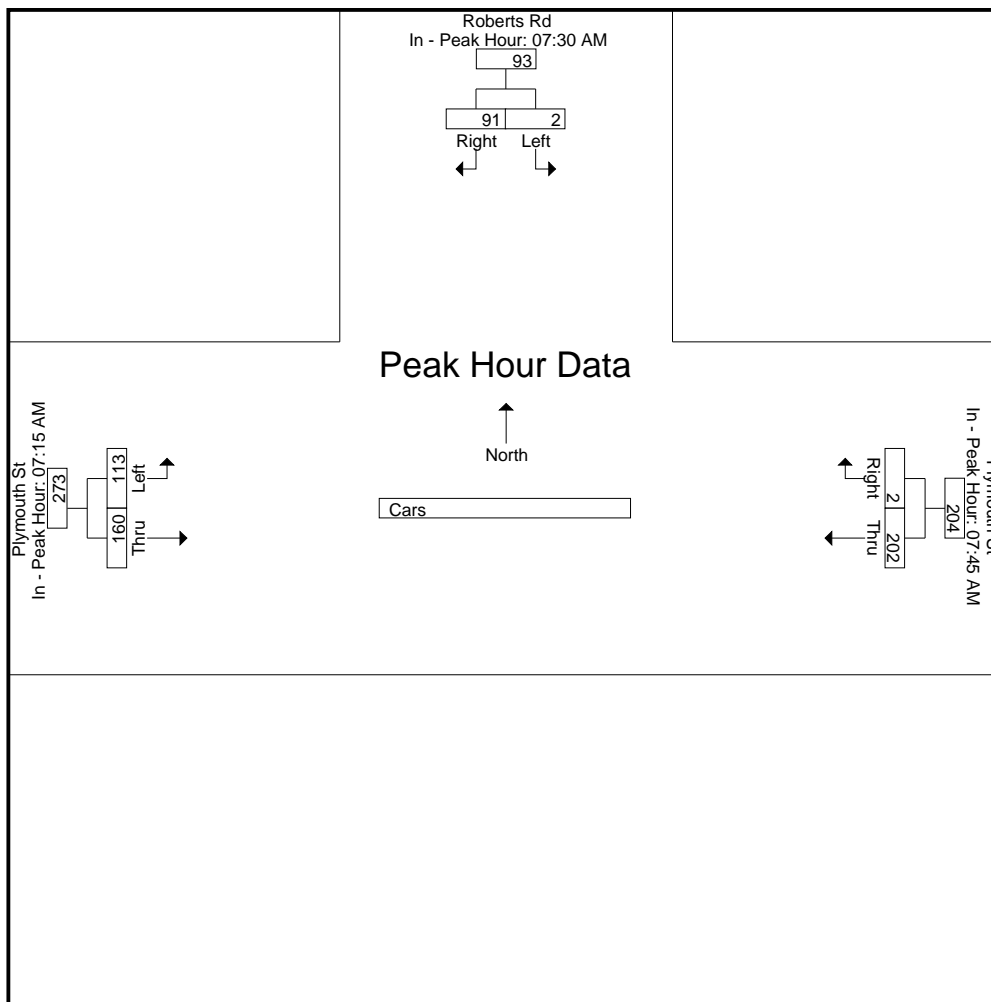

# Accurate Counts

978-664-2565

N/S Street : Roberts Road  
 E/W Street : Plymouth Street  
 City/State : Bridgewater, MA  
 Weather : Clear

File Name : 20270B22  
 Site Code : 20270022  
 Start Date : 10/2/2024  
 Page No : 7

### Groups Printed- Trucks

Start Time	Roberts Rd From North		Plymouth St From East		Plymouth St From West		Int. Total
	Left	Right	Thru	Right	Left	Thru	
07:00 AM	0	1	2	0	1	4	8
07:15 AM	0	1	1	0	2	4	8
07:30 AM	0	0	2	0	0	3	5
07:45 AM	0	1	6	1	1	5	14
<b>Total</b>	<b>0</b>	<b>3</b>	<b>11</b>	<b>1</b>	<b>4</b>	<b>16</b>	<b>35</b>
08:00 AM	0	0	6	0	0	3	9
08:15 AM	0	0	2	0	0	6	8
08:30 AM	0	0	3	0	0	3	6
08:45 AM	1	2	6	0	0	6	15
<b>Total</b>	<b>1</b>	<b>2</b>	<b>17</b>	<b>0</b>	<b>0</b>	<b>18</b>	<b>38</b>
<b>Grand Total</b>	<b>1</b>	<b>5</b>	<b>28</b>	<b>1</b>	<b>4</b>	<b>34</b>	<b>73</b>
Apprch %	16.7	83.3	96.6	3.4	10.5	89.5	
Total %	1.4	6.8	38.4	1.4	5.5	46.6	

Start Time	Roberts Rd From North			Plymouth St From East			Plymouth St From West			Int. Total
	Left	Right	App. Total	Thru	Right	App. Total	Left	Thru	App. Total	
Peak Hour Analysis From 07:00 AM to 08:45 AM - Peak 1 of 1										
Peak Hour for Entire Intersection Begins at 08:00 AM										
08:00 AM	0	0	0	6	0	6	0	3	3	9
08:15 AM	0	0	0	2	0	2	0	6	6	8
08:30 AM	0	0	0	3	0	3	0	3	3	6
08:45 AM	1	2	3	6	0	6	0	6	6	15
<b>Total Volume</b>	<b>1</b>	<b>2</b>	<b>3</b>	<b>17</b>	<b>0</b>	<b>17</b>	<b>0</b>	<b>18</b>	<b>18</b>	<b>38</b>
% App. Total	33.3	66.7		100	0		0	100		
PHF	.250	.250	.250	.708	.000	.708	.000	.750	.750	.633

# Accurate Counts

978-664-2565

N/S Street : Roberts Road  
 E/W Street : Plymouth Street  
 City/State : Bridgewater, MA  
 Weather : Clear

File Name : 20270B22  
 Site Code : 20270022  
 Start Date : 10/2/2024  
 Page No : 8

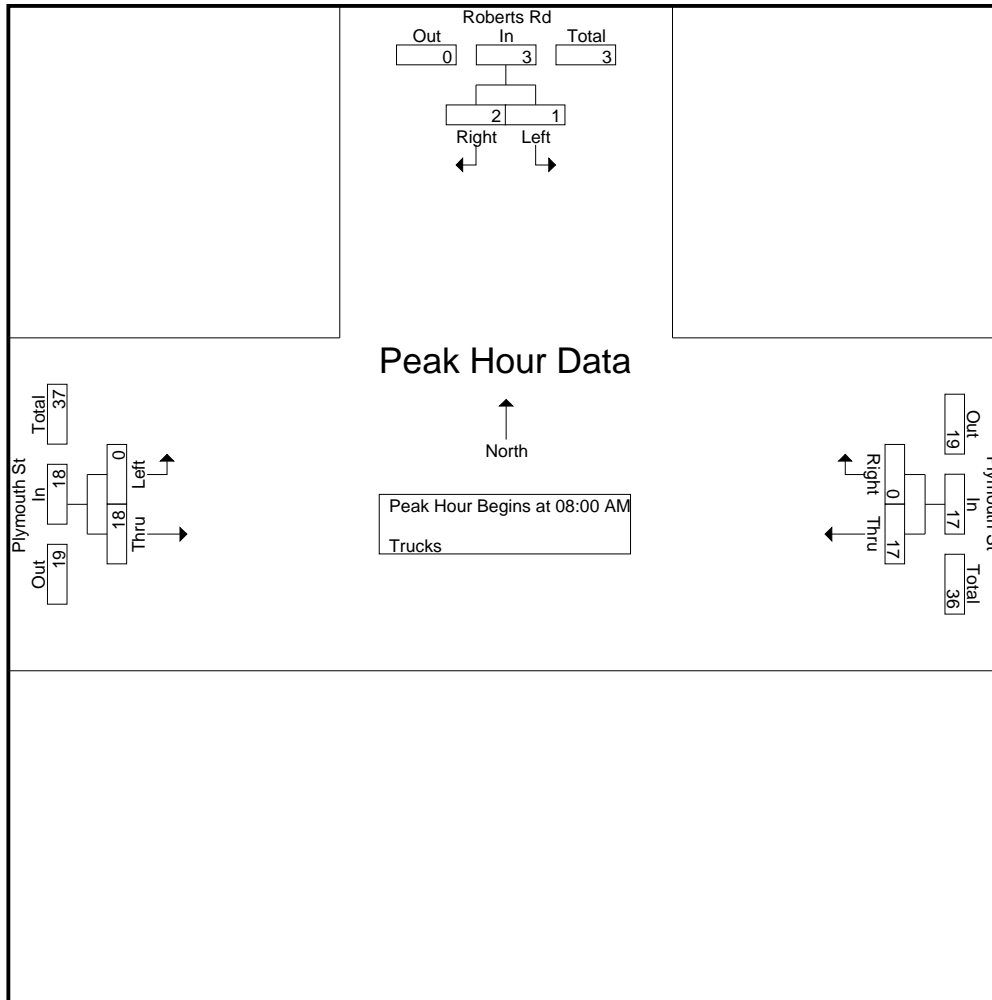

**Peak Hour Analysis From 07:00 AM to 08:45 AM - Peak 1 of 1**

Peak Hour for Each Approach Begins at:

	07:00 AM			07:45 AM			07:00 AM		
+0 mins.	0	1	1	6	1	7	1	4	5
+15 mins.	0	1	1	6	0	6	2	4	6
+30 mins.	0	0	0	2	0	2	0	3	3
+45 mins.	0	1	1	3	0	3	1	5	6
Total Volume	0	3	3	17	1	18	4	16	20
% App. Total	0	100		94.4	5.6		20	80	
PHF	.000	.750	.750	.708	.250	.643	.500	.800	.833



# Accurate Counts

978-664-2565

File Name : 20270B22

Site Code : 20270022

Start Date : 10/2/2024

Page No : 9

N/S Street : Roberts Road  
E/W Street : Plymouth Street  
City/State : Bridgewater, MA  
Weather : Clear

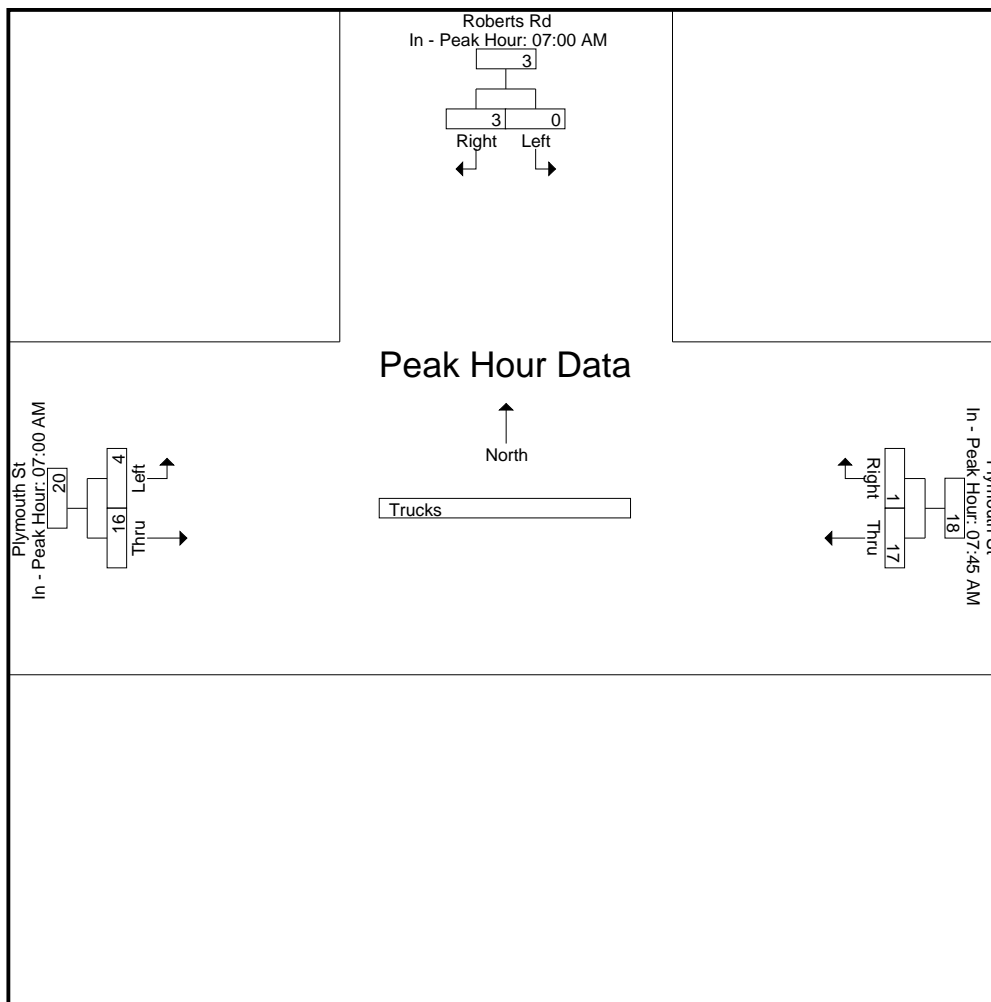



# Accurate Counts

978-664-2565

File Name : 20270B22

Site Code : 20270022

Start Date : 10/2/2024

Page No : 11

N/S Street : Roberts Road  
 E/W Street : Plymouth Street  
 City/State : Bridgewater, MA  
 Weather : Clear

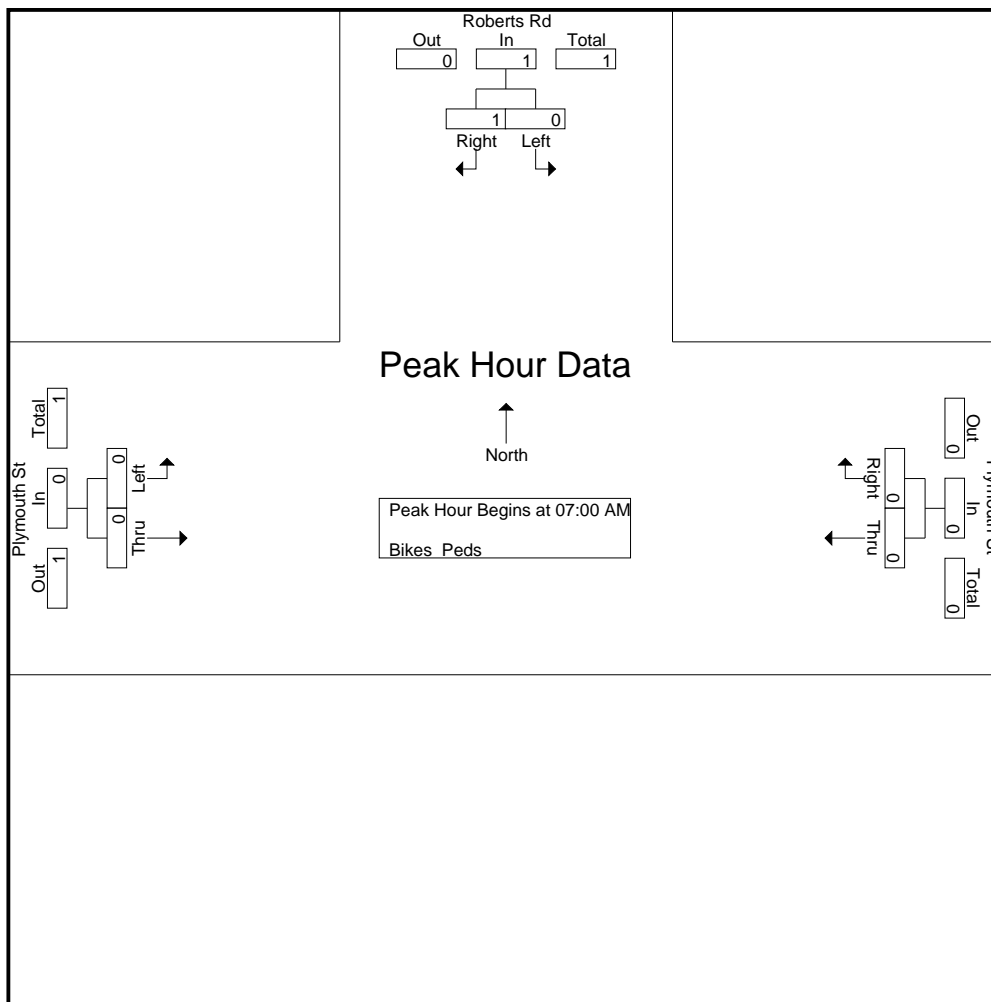

**Peak Hour Analysis From 07:00 AM to 08:45 AM - Peak 1 of 1**

Peak Hour for Each Approach Begins at:

	07:00 AM			07:00 AM			08:00 AM		
+0 mins.	0	0	0	0	0	0	0	0	0
+15 mins.	0	0	0	0	0	0	0	0	0
+30 mins.	0	0	0	0	0	0	0	0	0
+45 mins.	0	1	1	0	0	0	1	0	1
Total Volume	0	1	1	0	0	0	1	0	1
% App. Total	0	100		0	0		100	0	
PHF	.000	.250	.250	.000	.000	.000	.250	.000	.250

# Accurate Counts

978-664-2565

File Name : 20270B22

Site Code : 20270022

Start Date : 10/2/2024

Page No : 12

N/S Street : Roberts Road  
E/W Street : Plymouth Street  
City/State : Bridgewater, MA  
Weather : Clear

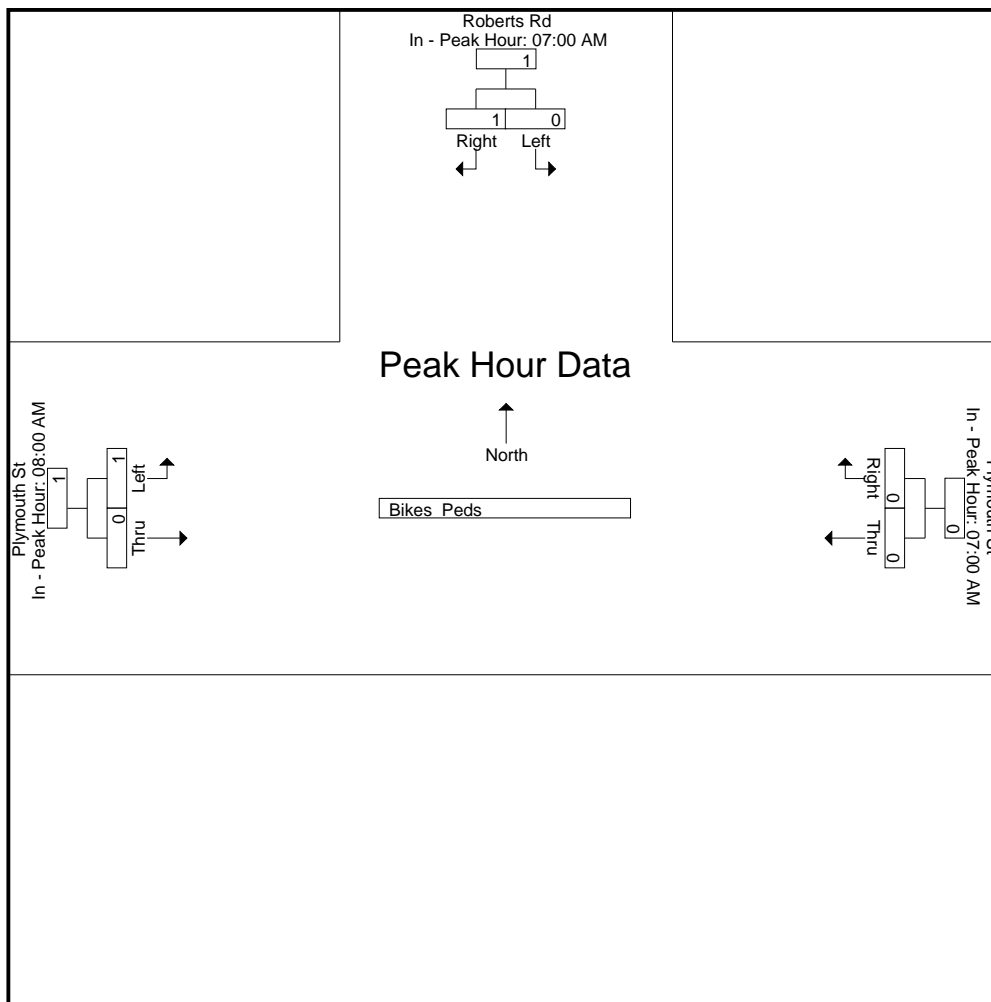

# Accurate Counts

978-664-2565

N/S Street : Roberts Road  
 E/W Street : Plymouth Street  
 City/State : Bridgewater, MA  
 Weather : Clear

File Name : 20270B22  
 Site Code : 20270022  
 Start Date : 10/2/2024  
 Page No : 1

### Groups Printed- Cars - Trucks

Start Time	Roberts Rd From North		Plymouth St From East		Plymouth St From West		Int. Total
	Left	Right	Thru	Right	Left	Thru	
04:00 PM	0	32	49	0	31	53	165
04:15 PM	1	45	43	0	20	42	151
04:30 PM	0	30	45	1	21	54	151
04:45 PM	0	21	62	1	34	59	177
<b>Total</b>	<b>1</b>	<b>128</b>	<b>199</b>	<b>2</b>	<b>106</b>	<b>208</b>	<b>644</b>
05:00 PM	0	38	58	1	25	46	168
05:15 PM	0	29	67	0	35	71	202
05:30 PM	0	31	61	0	27	47	166
05:45 PM	1	24	46	0	15	33	119
<b>Total</b>	<b>1</b>	<b>122</b>	<b>232</b>	<b>1</b>	<b>102</b>	<b>197</b>	<b>655</b>
<b>Grand Total</b>	<b>2</b>	<b>250</b>	<b>431</b>	<b>3</b>	<b>208</b>	<b>405</b>	<b>1299</b>
Apprch %	0.8	99.2	99.3	0.7	33.9	66.1	
Total %	0.2	19.2	33.2	0.2	16	31.2	
Cars	2	250	423	3	207	393	1278
% Cars	100	100	98.1	100	99.5	97	98.4
Trucks	0	0	8	0	1	12	21
% Trucks	0	0	1.9	0	0.5	3	1.6

Start Time	Roberts Rd From North			Plymouth St From East			Plymouth St From West			Int. Total
	Left	Right	App. Total	Thru	Right	App. Total	Left	Thru	App. Total	
Peak Hour Analysis From 04:00 PM to 05:45 PM - Peak 1 of 1										
Peak Hour for Entire Intersection Begins at 04:45 PM										
04:45 PM	0	21	21	62	1	63	34	59	93	177
05:00 PM	0	<b>38</b>	<b>38</b>	58	1	59	25	46	71	168
05:15 PM	0	29	29	<b>67</b>	0	<b>67</b>	<b>35</b>	<b>71</b>	<b>106</b>	<b>202</b>
05:30 PM	0	31	31	61	0	61	27	47	74	166
Total Volume	0	119	119	248	2	250	121	223	344	713
% App. Total	0	100		99.2	0.8		35.2	64.8		
PHF	.000	.783	.783	.925	.500	.933	.864	.785	.811	.882
Cars	0	119	119	246	2	248	120	220	340	707
% Cars	0	100	100	99.2	100	99.2	99.2	98.7	98.8	99.2
Trucks	0	0	0	2	0	2	1	3	4	6
% Trucks	0	0	0	0.8	0	0.8	0.8	1.3	1.2	0.8

# Accurate Counts

978-664-2565

N/S Street : Roberts Road  
 E/W Street : Plymouth Street  
 City/State : Bridgewater, MA  
 Weather : Clear

File Name : 20270B22  
 Site Code : 20270022  
 Start Date : 10/2/2024  
 Page No : 2

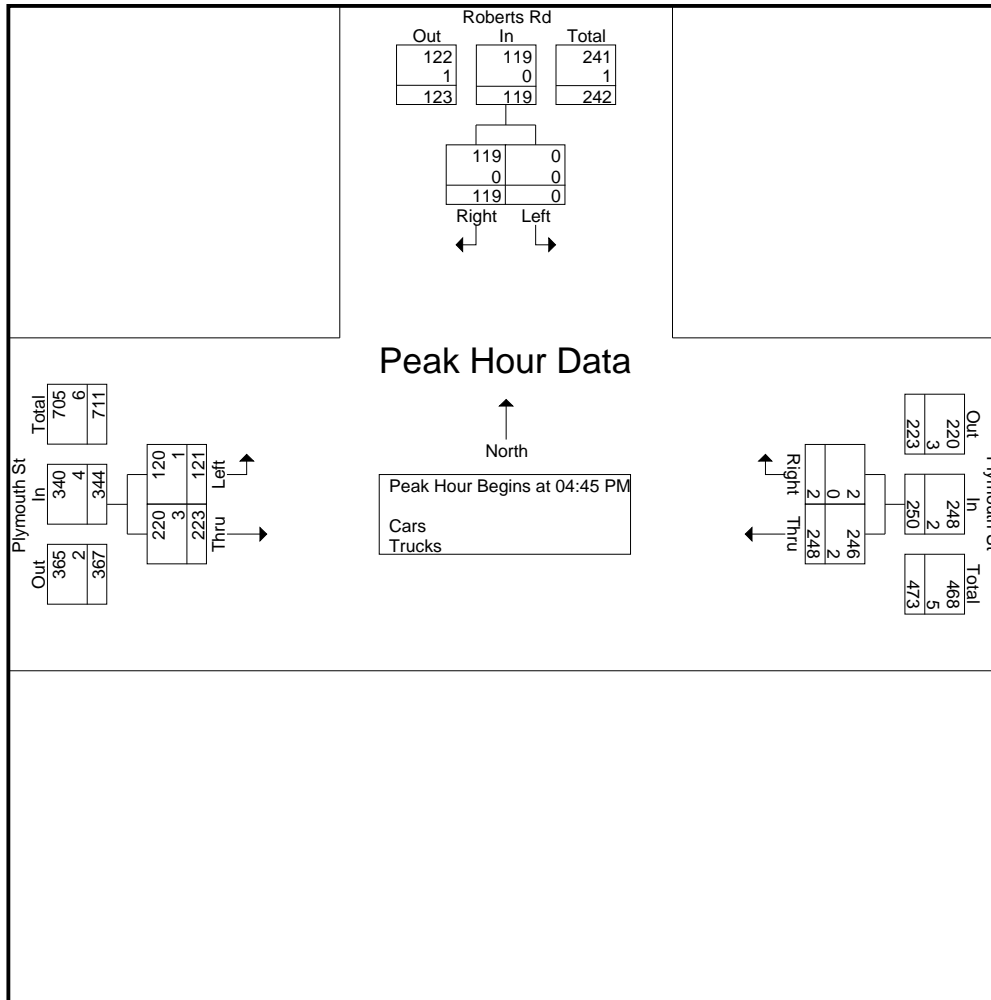

**Peak Hour Analysis From 04:00 PM to 05:45 PM - Peak 1 of 1**

Peak Hour for Each Approach Begins at:

	04:15 PM			04:45 PM			04:30 PM		
+0 mins.	1	45	46	62	1	63	21	54	75
+15 mins.	0	30	30	58	1	59	34	59	93
+30 mins.	0	21	21	<b>67</b>	0	<b>67</b>	25	46	71
+45 mins.	0	38	38	61	0	61	<b>35</b>	<b>71</b>	<b>106</b>
Total Volume	1	134	135	248	2	250	115	230	345
% App. Total	0.7	99.3		99.2	0.8		33.3	66.7	
PHF	.250	.744	.734	.925	.500	.933	.821	.810	.814
Cars	1	134	135	246	2	248	115	225	340
% Cars	100	100	100	99.2	100	99.2	100	97.8	98.6
Trucks	0	0	0	2	0	2	0	5	5
% Trucks	0	0	0	0.8	0	0.8	0	2.2	1.4

# Accurate Counts

978-664-2565

File Name : 20270B22

Site Code : 20270022

Start Date : 10/2/2024

Page No : 3

N/S Street : Roberts Road  
 E/W Street : Plymouth Street  
 City/State : Bridgewater, MA  
 Weather : Clear

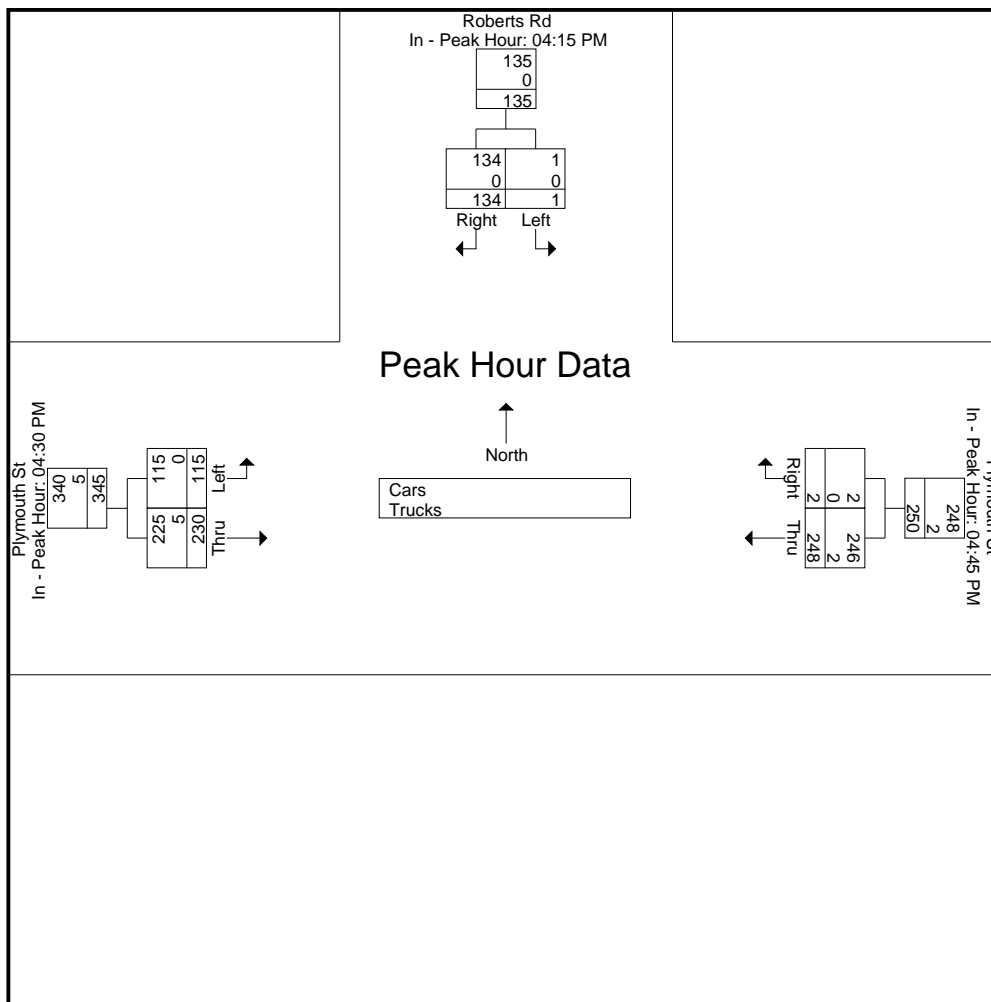

# Accurate Counts

978-664-2565

N/S Street : Roberts Road  
 E/W Street : Plymouth Street  
 City/State : Bridgewater, MA  
 Weather : Clear

File Name : 20270B22  
 Site Code : 20270022  
 Start Date : 10/2/2024  
 Page No : 4

### Groups Printed- Cars

Start Time	Roberts Rd From North		Plymouth St From East		Plymouth St From West		Int. Total
	Left	Right	Thru	Right	Left	Thru	
04:00 PM	0	32	47	0	31	49	159
04:15 PM	1	45	39	0	20	40	145
04:30 PM	0	30	45	1	21	52	149
04:45 PM	0	21	62	1	34	56	174
<b>Total</b>	<b>1</b>	<b>128</b>	<b>193</b>	<b>2</b>	<b>106</b>	<b>197</b>	<b>627</b>
05:00 PM	0	38	57	1	25	46	167
05:15 PM	0	29	66	0	35	71	201
05:30 PM	0	31	61	0	26	47	165
05:45 PM	1	24	46	0	15	32	118
<b>Total</b>	<b>1</b>	<b>122</b>	<b>230</b>	<b>1</b>	<b>101</b>	<b>196</b>	<b>651</b>
<b>Grand Total</b>	<b>2</b>	<b>250</b>	<b>423</b>	<b>3</b>	<b>207</b>	<b>393</b>	<b>1278</b>
Apprch %	0.8	99.2	99.3	0.7	34.5	65.5	
Total %	0.2	19.6	33.1	0.2	16.2	30.8	

Start Time	Roberts Rd From North			Plymouth St From East			Plymouth St From West			Int. Total
	Left	Right	App. Total	Thru	Right	App. Total	Left	Thru	App. Total	
Peak Hour Analysis From 04:00 PM to 05:45 PM - Peak 1 of 1										
Peak Hour for Entire Intersection Begins at 04:45 PM										
04:45 PM	0	21	21	62	1	63	34	56	90	174
05:00 PM	0	<b>38</b>	<b>38</b>	57	1	58	25	46	71	167
05:15 PM	0	29	29	<b>66</b>	0	<b>66</b>	<b>35</b>	<b>71</b>	<b>106</b>	<b>201</b>
05:30 PM	0	31	31	61	0	61	26	47	73	165
<b>Total Volume</b>	0	119	119	246	2	248	120	220	340	707
% App. Total	0	100		99.2	0.8		35.3	64.7		
PHF	.000	.783	.783	.932	.500	.939	.857	.775	.802	.879



# Accurate Counts

978-664-2565

N/S Street : Roberts Road  
 E/W Street : Plymouth Street  
 City/State : Bridgewater, MA  
 Weather : Clear

File Name : 20270B22  
 Site Code : 20270022  
 Start Date : 10/2/2024  
 Page No : 5

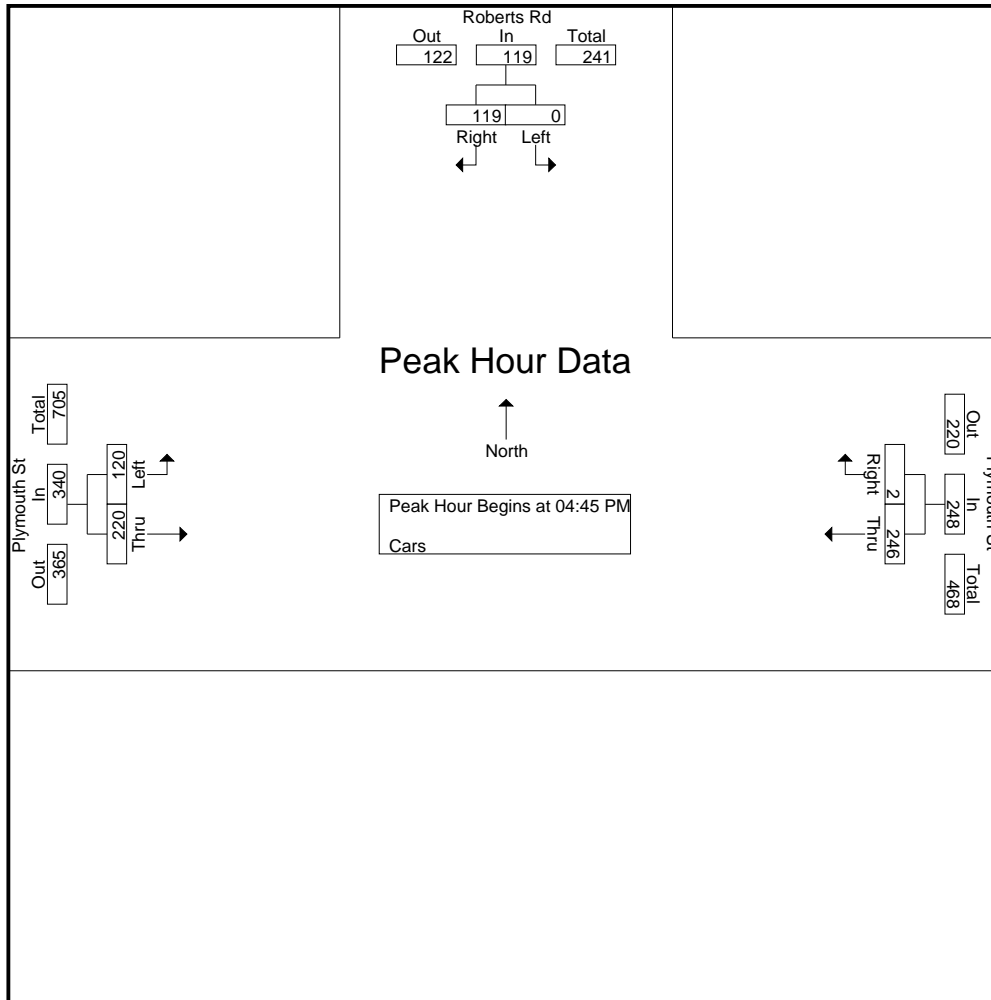

**Peak Hour Analysis From 04:00 PM to 05:45 PM - Peak 1 of 1**

Peak Hour for Each Approach Begins at:

	04:15 PM			04:45 PM			04:30 PM		
+0 mins.	1	45	46	62	1	63	21	52	73
+15 mins.	0	30	30	57	1	58	34	56	90
+30 mins.	0	21	21	<b>66</b>	0	<b>66</b>	25	46	71
+45 mins.	0	38	38	61	0	61	<b>35</b>	<b>71</b>	<b>106</b>
Total Volume	1	134	135	246	2	248	115	225	340
% App. Total	0.7	99.3		99.2	0.8		33.8	66.2	
PHF	.250	.744	.734	.932	.500	.939	.821	.792	.802

# Accurate Counts

978-664-2565

File Name : 20270B22

Site Code : 20270022

Start Date : 10/2/2024

Page No : 6

N/S Street : Roberts Road  
E/W Street : Plymouth Street  
City/State : Bridgewater, MA  
Weather : Clear

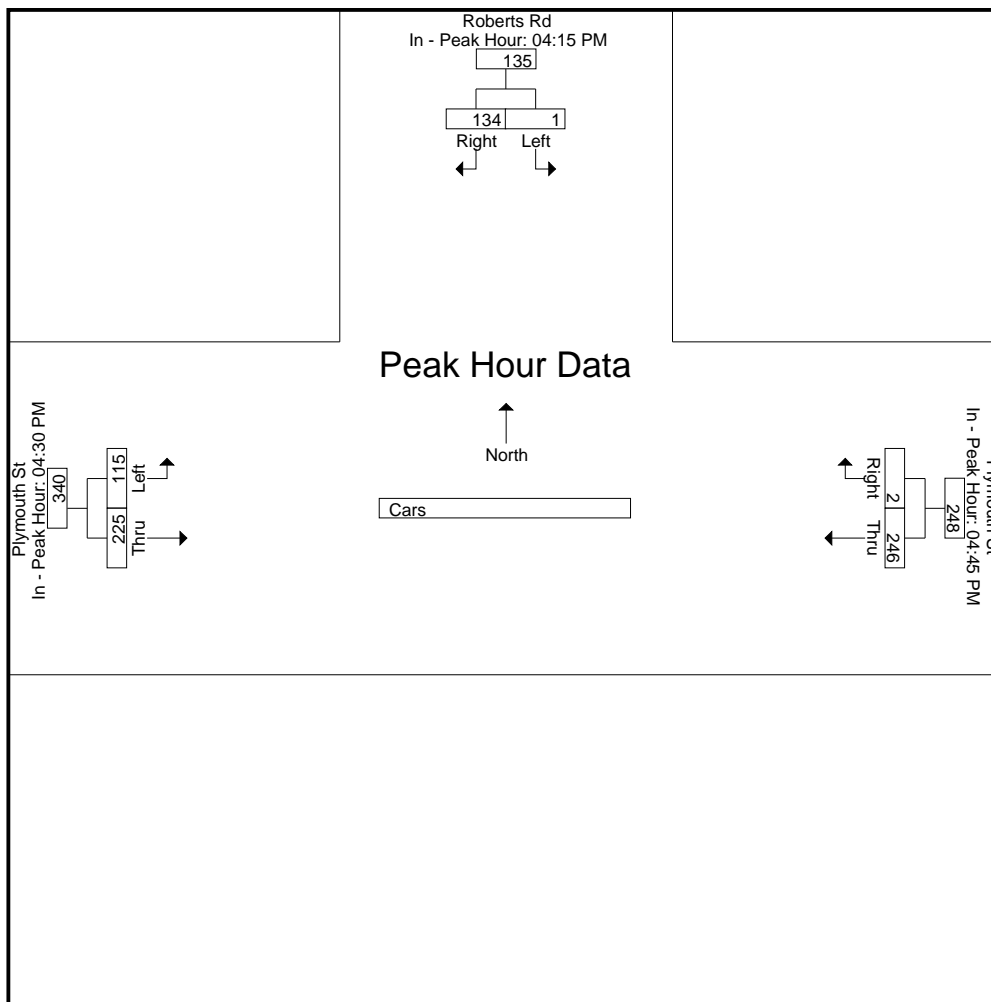

# Accurate Counts

978-664-2565

N/S Street : Roberts Road  
 E/W Street : Plymouth Street  
 City/State : Bridgewater, MA  
 Weather : Clear

File Name : 20270B22  
 Site Code : 20270022  
 Start Date : 10/2/2024  
 Page No : 7

### Groups Printed- Trucks

Start Time	Roberts Rd From North		Plymouth St From East		Plymouth St From West		Int. Total
	Left	Right	Thru	Right	Left	Thru	
04:00 PM	0	0	2	0	0	4	6
04:15 PM	0	0	4	0	0	2	6
04:30 PM	0	0	0	0	0	2	2
04:45 PM	0	0	0	0	0	3	3
<b>Total</b>	0	0	6	0	0	11	17
05:00 PM	0	0	1	0	0	0	1
05:15 PM	0	0	1	0	0	0	1
05:30 PM	0	0	0	0	1	0	1
05:45 PM	0	0	0	0	0	1	1
<b>Total</b>	0	0	2	0	1	1	4
<b>Grand Total</b>	0	0	8	0	1	12	21
Apprch %	0	0	100	0	7.7	92.3	
Total %	0	0	38.1	0	4.8	57.1	

Start Time	Roberts Rd From North			Plymouth St From East			Plymouth St From West			Int. Total
	Left	Right	App. Total	Thru	Right	App. Total	Left	Thru	App. Total	
Peak Hour Analysis From 04:00 PM to 05:45 PM - Peak 1 of 1										
Peak Hour for Entire Intersection Begins at 04:00 PM										
04:00 PM	0	0	0	2	0	2	0	4	4	6
04:15 PM	0	0	0	4	0	4	0	2	2	6
04:30 PM	0	0	0	0	0	0	0	2	2	2
04:45 PM	0	0	0	0	0	0	0	3	3	3
<b>Total Volume</b>	0	0	0	6	0	6	0	11	11	17
<b>% App. Total</b>	0	0	0	100	0	100	0	100	100	100
PHF	.000	.000	.000	.375	.000	.375	.000	.688	.688	.708

# Accurate Counts

978-664-2565

File Name : 20270B22

Site Code : 20270022

Start Date : 10/2/2024

Page No : 8

N/S Street : Roberts Road

E/W Street : Plymouth Street

City/State : Bridgewater, MA

Weather : Clear

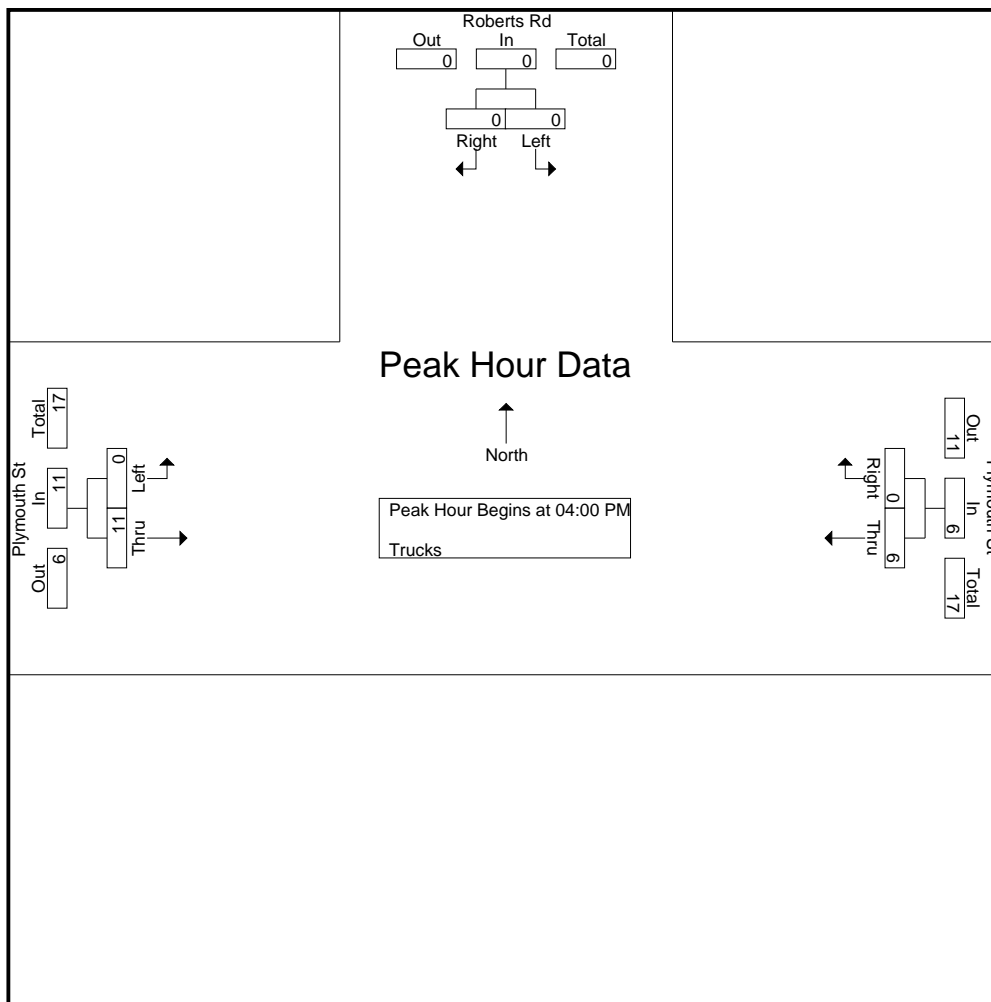

Peak Hour Analysis From 04:00 PM to 05:45 PM - Peak 1 of 1

Peak Hour for Each Approach Begins at:

	04:00 PM			04:00 PM			04:00 PM		
+0 mins.	0	0	0	2	0	2	0	4	4
+15 mins.	0	0	0	4	0	4	0	2	2
+30 mins.	0	0	0	0	0	0	0	2	2
+45 mins.	0	0	0	0	0	0	0	3	3
<b>Total Volume</b>	0	0	0	6	0	6	0	11	11
<b>% App. Total</b>	0	0	0	100	0	100	0	100	100
<b>PHF</b>	.000	.000	.000	.375	.000	.375	.000	.688	.688

# Accurate Counts

978-664-2565

File Name : 20270B22

Site Code : 20270022

Start Date : 10/2/2024

Page No : 9

N/S Street : Roberts Road  
E/W Street : Plymouth Street  
City/State : Bridgewater, MA  
Weather : Clear

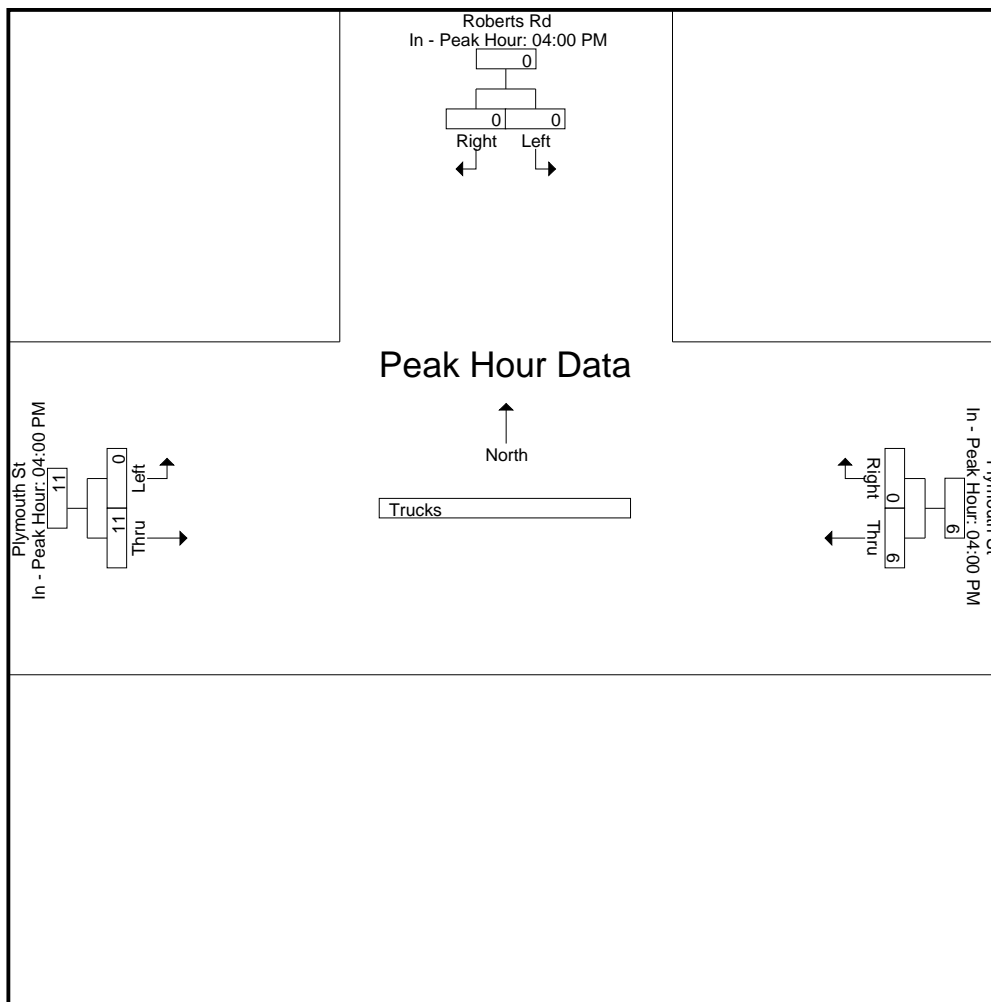





# Accurate Counts

978-664-2565

N/S Street : Roberts Road  
E/W Street : Plymouth Street  
City/State : Bridgewater, MA  
Weather : Clear

File Name : 20270B22  
Site Code : 20270022  
Start Date : 10/2/2024  
Page No : 12

